

Corning® Cell Counter

Accurate Cell Counts in a Flash

Instruction Manual

Cat. No. 6749

CORNING



Table of Contents

Safety Information	4
1.0 Introduction	5
Technology to Make Your Work Easier	5
How Easy the Corning® Cell Counter Works.....	5
Operating Range	5
Instrument Overview.....	6
2.0 Getting Started	7
3.0 Setting Up the Corning Cell Counter	8
Setup Procedure.....	8
Registration of the Device	9
Error Codes	10
Start a Project.....	11
Start a Cell Count	12
Adapter Plate Placement	12
Sample Loading	13
Live/Dead Sample Loading.....	14
Counting Chamber Placement	14
4.0 Performing a Cell Count	15
Focusing of the Cells.....	15
Performing a Count	16
5.0 Connecting to the Cloud	17
Project Overview	18
Experiment Overview.....	19
Experiment Results.....	20

6.0 Cleaning and Troubleshooting	22
Cleaning and Maintenance	22
Troubleshooting	22
USB device does not connect	22
No cells are visible	22
Too many cells	23
Cell clumps	23
Bubbles	24
Debris	24
7.0 Technical Specifications	25
8.0 Limited Warranty	26
9.0 Equipment Disposal	27
Appendix A	
Trypan Blue Dilution Calculation and Histogram Gating for Corning® Cell Counter	28

Safety Information

To avoid damage or malfunction of the Corning® Cell Counter:

- ▶ Be sure to set this device on a firm, stable, and horizontal surface.
- ▶ Shut down the device if it produces smoke, a strange odor or unusual noise. Continued use may lead to fire. Unplug the USB cable immediately.
- ▶ Do not connect the USB cable in ways other than those mentioned in this manual.
- ▶ If water or other liquid enters the device, discontinue use immediately. Continued use may lead to fire. Unplug the USB cable immediately.
- ▶ Do not attempt to repair or remove the outer case of the device.
- ▶ Never attempt to repair, disassemble, or modify this device yourself, as tampering with this product may result in injury or fire.
- ▶ Do not drop the device or allow objects to fall onto it.
- ▶ Do not allow the device to be submerged in liquid.
- ▶ Do not place heavy objects on top of this device, and never stand or lean on this device. Failure to follow this may cause the equipment to fall or collapse, which may result in possible breakage and/or injury.
- ▶ Do not autoclave this device.
- ▶ Do not perform the sterilization cycle of an incubator with the device inside.
- ▶ Do not use acetone to clean the device.



1.0 Introduction

Technology to Make Your Work Easier

Thank you for purchasing the Corning® Cell Counter.

The Corning Cell Counter is a benchtop automated image-based cell counter, which uses state of the art optics and image analysis software. Its innovative design combines the best qualities of manual cell counting with those of automated image-based cell counting. With this, the Corning Cell Counter can accurately and precisely measure cell concentrations and viability – live, dead, and total cells – using the standard Trypan blue technique.

NOTE: The Corning Cell Counter is a cloud-based system, which means that you'll receive new upgrades automatically as they become available.

Visit www.corning.com/cellcounterupdates to check the latest updates.

How Easy the Corning Cell Counter Works

The Corning Cell Counter system can be installed within several minutes and requires minimal training.

The Corning Cell Counter uses a standard counting chamber or customer supplied hemocytometer to analyze cell samples. Images from the cell sample are obtained by CytoSMART™ application analyses of these images in the cloud. Sophisticated image analysis algorithms produce accurate cell counts within a few seconds.

You can directly obtain your cell concentration on the results page or look it up later on the CytoSMART Connect.

Operating Range

The Corning Cell Counter can be used to determine cell concentrations of mammalian cells. The system works within a cell size range between 10 to 70 µm. Expect accurate results for concentration samples within a range of 5×10^4 to 1×10^7 cells/mL.

Instrument Overview

The hardware of the Corning® Cell Counter is shown below (Figure 1):

1. **Light arc** – Contains the light source for imaging
2. **USB cable** – For connecting the device via USB (3.0 or higher), which is also the power source for the device
3. **Optical window** – Cover glass on which the counting chamber is placed
4. **Adapter plate** – Used to guide the counting chamber across the optical window
5. **Focus knob** – Allows for changing the focus of the image

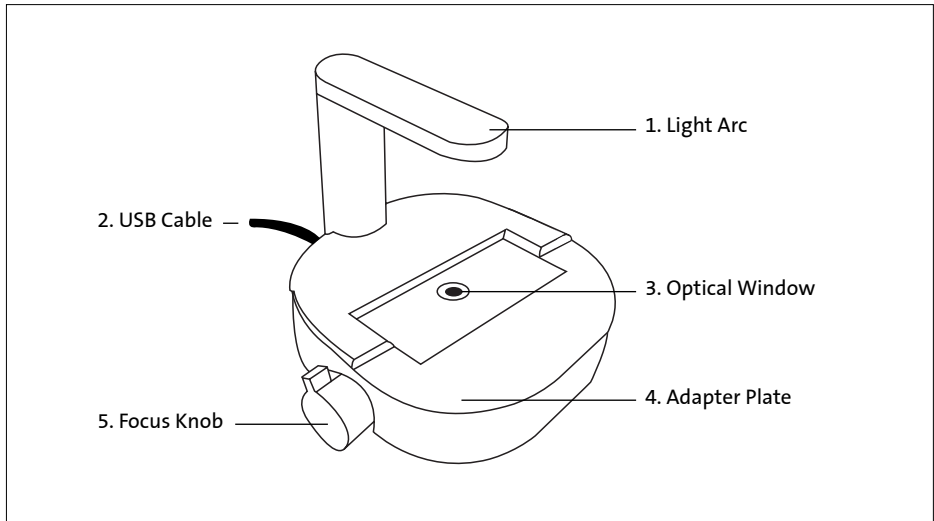

Figure 1. Instrument overview of the Corning Cell Counter

2.0 Getting Started

Product contents include the following items (Figure 2):

1. Manual and Quick Starter Guide
2. Corning® Cell Counter
3. License key
4. Adapter plate for the counting chamber
5. Counting chamber with two cover slips
6. Download link to the CytoSMART™ application software
7. USB drive for software

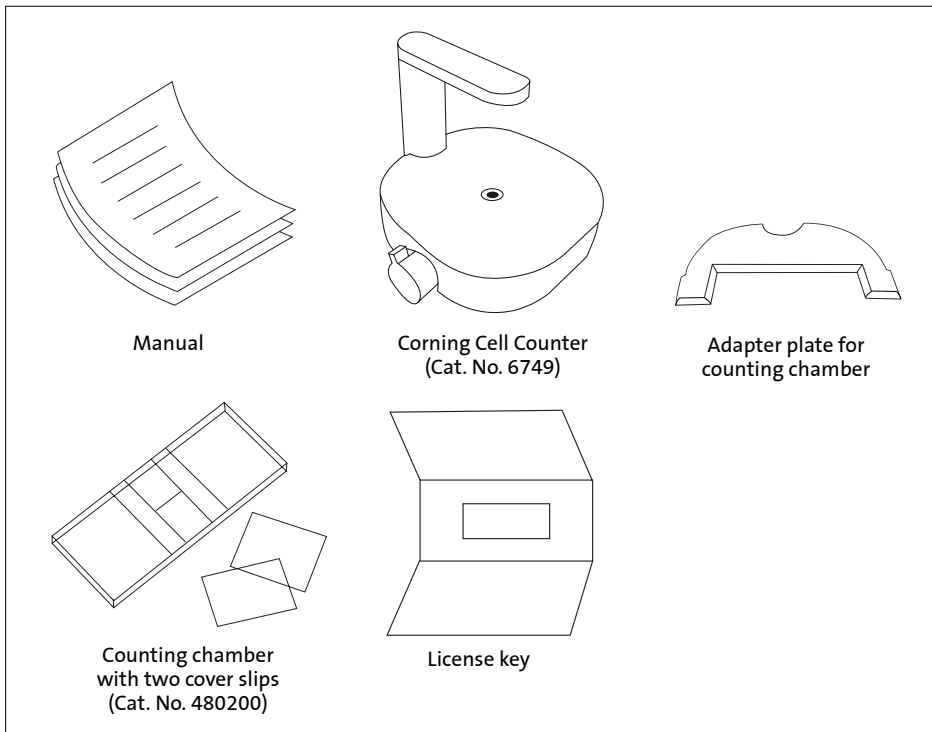

Figure 2. Package overview

For additional information or any questions regarding your purchase, visit www.cytosmart.com/support or contact our support staff at corning.support@cytosmart.com.

3.0 Setting Up the Corning® Cell Counter

To set up the Corning Cell Counter, the following items are needed:

- ▶ A Windows® 10 computer with internet access (preferably via a LAN-cable), and a USB port (USB 3.0 or higher). The computer or tablet must be on AC power, rather than on battery power.
- ▶ The Corning Cell Counter
- ▶ The download link for the CytoSMART™ application software: download.cytosmart.com
- ▶ A license key to activate the device within the software

Setup Procedure

1. Open an internet browser and download the CytoSMART application using the download link provided. If no link has been provided, please contact your sales representative or contact our support staff via corning.support@cytosmart.com.
2. When the download is finished, double click the file to install the CytoSMART application on the Windows computer.
3. Be sure to remove any wrapping before first time use of the Corning Cell Counter. Also clean the device with a damp, lint-free wipe to clean the outer case with 70% ethanol or isopropanol. After the installation has completed, an icon for the CytoSMART application will be visible on the desktop (Figure 3).
4. Start the CytoSMART application by double clicking the icon on the desktop. A notification to connect the device will appear (Figure 4).
5. Next, connect the cleaned Corning Cell Counter to the Windows computer using the USB cable. Connect via USB 3.0 port. This is required for optimal performance.
6. When the Corning Cell Counter is connected, the green LED will activate in the light arc. This indicates that the device is ready for use.



Figure 3. CytoSMART application icon



Figure 4. Connect the device notification

Registration of the Device

Before you can use the Corning® Cell Counter, you must register it. By clicking on the “Register a new user” button (Figure 5), you will be led to the registration form (Figure 6). Please fill in all the details and click “Sign up”.



The image shows a 'Sign in' form with two input fields: 'Email' and 'Password'. Below the fields is a 'Sign in' button. To the right of the form, there is a link 'Don't have an account?' with a 'Register' button next to it. At the bottom left, there is a link 'Forgot password?'.

Figure 5. Create an account

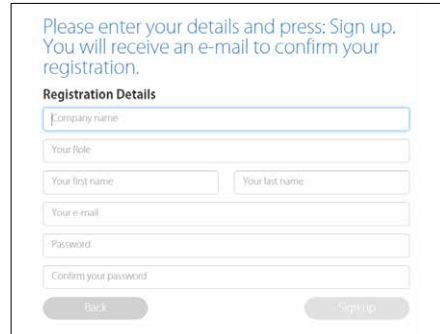

The image shows a 'Sign up' registration form. At the top, it says 'Please enter your details and press: Sign up. You will receive an e-mail to confirm your registration.' Below this is a section titled 'Registration Details' with several input fields: 'Company name', 'Your Role', 'Your first name', 'Your last name', 'Your e-mail', 'Password', and 'Confirm your password'. At the bottom, there are 'Back' and 'Sign up' buttons.

Figure 6. Sign up registration form

The next step is to register the device. In the product box, you will find the license key for this device. Enter the license key that is provided in the field “License” and click “Register” (Figure 7).

Congratulations, you have now successfully registered and activated your Corning Cell Counter!

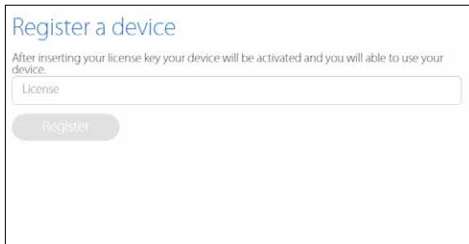

The image shows a 'Register a device' form. It has a title 'Register a device' and a sub-header 'After inserting your license key your device will be activated and you will be able to use your device.' Below this is a 'License' input field and a 'Register' button.

Figure 7. Register a device

✘ Error Code: Multiple Customer Environments

Is your personal account linked to more than one company? In that case, you will see the comment box as shown in Figure 8 after signing in with your email address and password. Select the desired environment that you would like to use from the drop-down menu and click “Select”. This will lead you to the right environment to start your project.

Signing In

If your device is already activated and you already have an account, you can easily sign in. Fill in your email address and password, and click “Log in” (Figure 9).

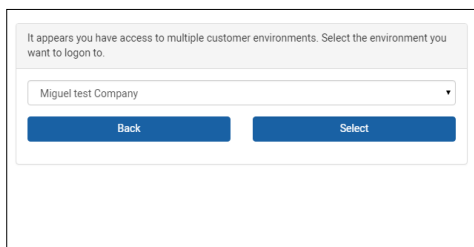

Figure 8. Select an environment

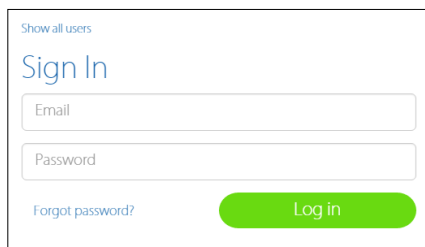

Figure 9. Sign in

✘ Error Code: Wrong Account or Company

If your personal account is not connected to the environment of the device, you will see a warning (Figure 10). This means that the device is already activated and registered to a company, but your personal account is not linked to this company.



Figure 10. Warning: account not connected to environment

Start a Project

With the Corning® Cell Counter you can perform a single count or multiple counts within a project. The CytoSMART™ application software automatically stores the results within a project, which you can view later in the CytoSMART Connect.

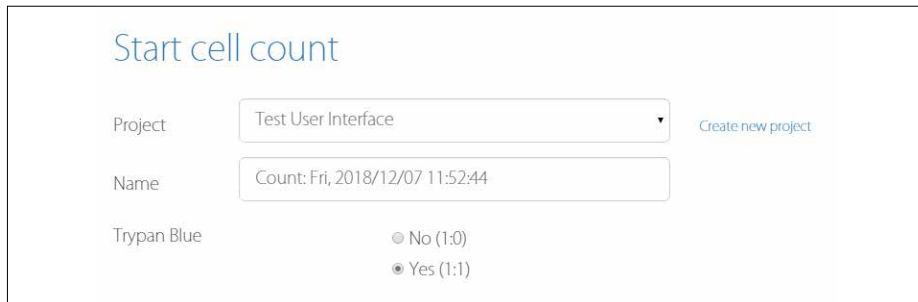

The screenshot shows a web interface titled "Start cell count". It contains the following elements:

- A "Project" dropdown menu with "Test User Interface" selected. To its right is a link that says "Create new project".
- A "Name" text input field containing "Count: Fri, 2018/12/07 11:52:44".
- A "Trypan Blue" section with two radio buttons: "No (1:0)" and "Yes (1:1)". The "Yes (1:1)" option is selected.

Figure 11. Name your experiment before starting a cell count, and then select whether you have added Trypan blue to your cells or not. The default is “Yes (1:1).”

After selecting “Create a new project” (Figure 11), you will be led to the “Start a project” page (Figure 12). Next to the project owner details, which are already filled in, you can also fill in the email address of collaborating users such as your colleagues. Name the project, and give it a description. The final step is to assign a colored icon to the project. This helps you to find your project easily, based on the color of the icon.

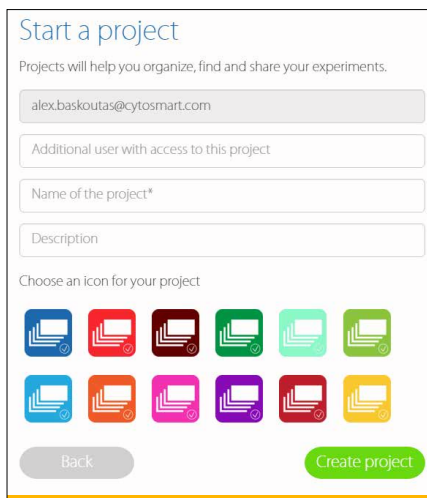

The screenshot shows a web interface titled "Start a project". It contains the following elements:

- A sub-header: "Projects will help you organize, find and share your experiments."
- A text input field containing "alex.baskoutas@cytosmart.com".
- A text input field for "Additional user with access to this project".
- A text input field for "Name of the project*".
- A text input field for "Description".
- A section titled "Choose an icon for your project" with a grid of 12 colored icons (blue, red, brown, green, light green, yellow, orange, pink, purple, dark red, yellow-orange).
- At the bottom, there are two buttons: "Back" and "Create project".

Figure 12. Start a project

Start a Cell Count

To start a cell count, you need to create an experiment. First, select the project that your experiment belongs to using the drop-down menu (Figure 11). If the cell count doesn't belong to any of the projects shown, click "Create a new project" to create a new project.

Next, give the cell count a name. We recommend always including the date of the cell count in the file name to easily find the experiment later on. After entering the details, click "Start cell count" (Figure 13) and count your cells!

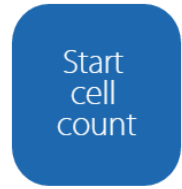

Figure 13. Start cell count

Adapter Plate Placement

You can use the adapter plate to guide the counting chamber during image acquisition of the sample. We recommend to place the adapter plate on the Corning® Cell Counter, but this is not required to perform a cell count. Using the adapter plate will produce the most reliable results, as it allows for precise and repeatable handling of the counting chamber.

To install the adapter plate:

- ▶ Make sure that both the Corning Cell Counter and the adapter plate are clear of any debris. **Note:** Use a lint-free wipe to clean the device, if needed.
- ▶ Carefully slide the notch of the adapter plate around the base of the light arc (Figure 14).
- ▶ Push the adapter plate downwards, until it clicks into place on-top of the Corning Cell Counter (Figure 15).

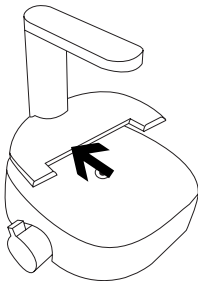

Figure 14. Slide the adapter plate into place.

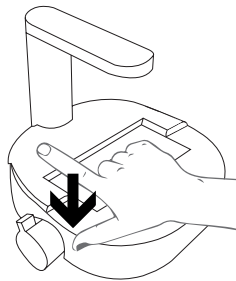

Figure 15. Carefully press the adapter plate downwards.

- ▶ Ensure the adapter plate is correctly placed. If it is placed incorrectly, this can lead to false results (Figure 16).
- ▶ To remove the adapter plate, carefully pull it upwards near the base of the light arc. Then carefully slide the plate from the Corning® Cell Counter.

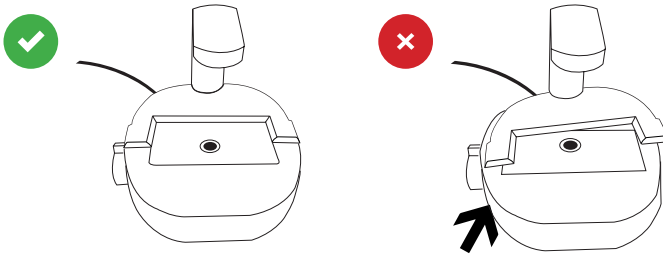

Figure 16. Correct adapter plate placement

Sample Loading

A counting chamber is used for cell sample analysis. Most common hemocytometers are compatible with the Corning Cell Counter. This is because these counting chambers have a similar counting chamber depth of 0.1 mm.

The Corning Cell Counter does not require the counting grid to be included to perform a cell count. For higher throughput applications, you can also use disposable counting slides, if they have a counting chamber depth of 0.1 mm. The Corning counting chamber (Cat. No. 480200) is a reusable glass cell counting slide for the Corning Cell Counter. This gridless slide has a 0.1 mm depth, the same as a Neubauer hemocytometer, and comes standard with two high quality cover slips. These slides have a notch for easy loading of cell suspension.

Load the counting chamber with a cell sample according to your loading protocol. We recommend loading 10 μL of the sample in the counting chamber with a 10 μL or 20 μL pipet. The Corning Cell Counter operates within a concentration range of 5×10^4 to 1×10^7 cells/mL. If the cell solution is out of this concentration range, use culture medium to resuspend the cells in an appropriate volume; otherwise, you may obtain false results.

Live/Dead Sample Loading

To perform a live/dead analysis, we recommend using the standard Trypan blue technique. Mix a minimum of 20 μL sample with 20 μL trypan blue by using a 20 μL pipet. Next load 10 μL of the sample mixture into the counting chamber.

Counting Chamber Placement

The optical window of the Corning® Cell Counter must be clean. You can check this by monitoring the live screen. If any debris is present, you will see it in the CytoSMART™ application.

If any debris is visible, clean the optical window using lint-free wipes before placing the counting chamber in the adapter plate.

When the sample is loaded in the counting chamber and the adapter plate has been installed, you can place the counting chamber in the adapter plate that has been inserted on the Corning Cell Counter.

4.0 Performing a Cell Count

After placing the loaded counting chamber on the Corning® Cell Counter, you can see an image of the cell sample in the live screen (Figure 17).

Focusing of the Cells

Use the focus knob to adjust the focus of the image. To focus, turn the knob clockwise or counter clockwise. For best results, ensure you have the correct focus on your tablet or PC.

For proper analysis, you should be seeing a contrast: living cells having bright centers and dark edges (Figure 18). To achieve this, using the focus knob, set the focus just above the cell.

We recommend trying multiple focus levels to determine which focus setting to use.

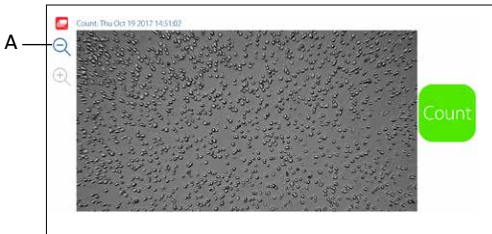

Figure 17. Live screen of the CytoSMART™ application

Important: The image seen on the live screen is a digital magnification of the field of view, to allow for better focusing. The unmagnified image can be seen by clicking on the magnifying glass (Figure 17A).

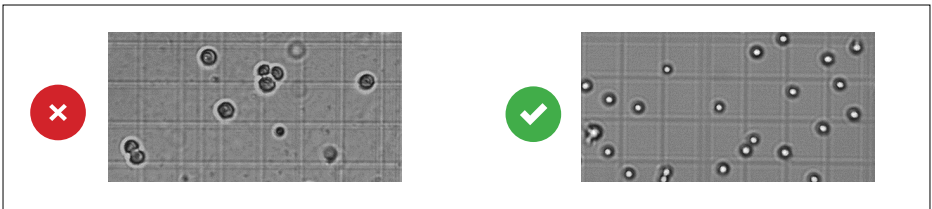

Figure 18. Correct focus settings

Performing a Count

When the focus is set, you are ready to perform a count. To obtain your cell count, follow the protocol below:

1. Make sure that the counting chamber is correctly placed in the adapter plate.
2. Check the image to see if the focus is correct – correct it if needed – and select “Count” from the start screen (Figure 17).
3. The CytoSMART™ application will now analyse the image and present the results. Within the analyzed image (Figure 19), you will see green and red circles (A). Green circles represent living cells, red circles are dead cells. Next to the image, the number of (live and dead) cells is displayed (B) together with experiment data (C).
4. In this window you can also add notes (D). These will be included in the CytoSMART Connect environment. You must click Save icon to save notes.
5. If you want to perform another cell count, simply press “Start new cell count” (E).

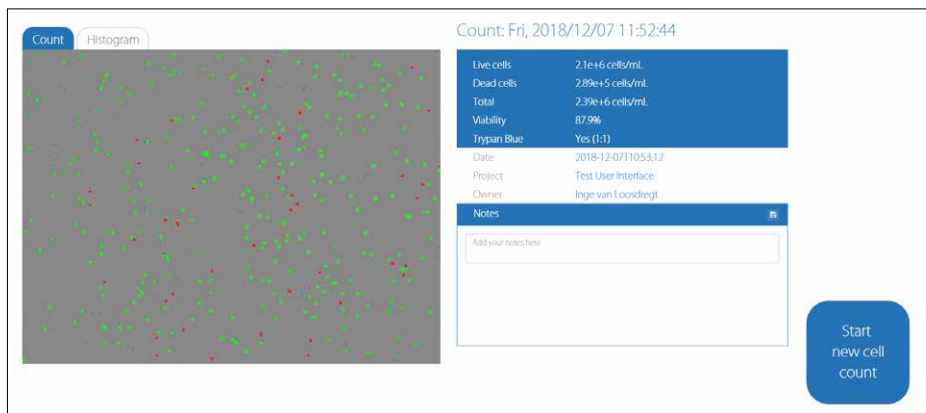

Figure 19. Overview of the result page

6. Trypan Blue Dilution Calculation and Histogram Gating:
For full instructions, please reference Appendix A.

5.0 Connecting to the Cloud

One of the features of the Corning® Cell Counter is that the experiment results can be accessed through the CytoSMART™ Connect. To access the cloud, the following items are required:

- ▶ PC, tablet, or another device with a web browser. NOTE: Does not work with Microsoft Internet Explorer.
- ▶ Active internet connection.
- ▶ Cloud login details.

After starting an experiment, the captured images will be stored in the cloud. To allow for this, make sure the system has an active internet connection. All time logs in the cloud are set to GMT. Link: <https://cloud.cytosmart.com>.

This link will lead you to the CytoSMART Connect login page (Figure 20). Log in using the credentials you created earlier. If you have multiple customer environments, choose which environment you would like to access (Figure 21).

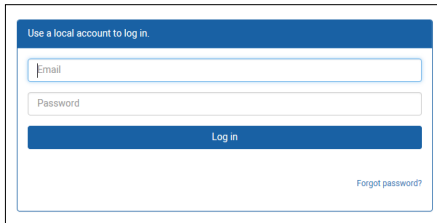

Figure 20. Connect login page

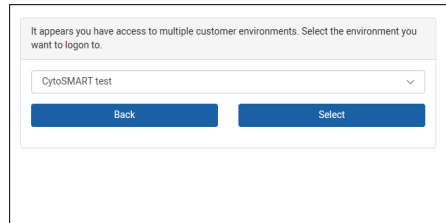

Figure 21. Choose an environment

Project Overview

After logging in to the Cloud, you will get access to an overview of all projects (Figure 22). Navigating the portal is simple. If you have multiple projects in an account, use the “Search Projects” bar (A) to quickly search for a project. To create a new project, select “New Project” (B). This is similar to beginning a new project, as described in Section 3. It is not possible to start an experiment from the cloud.

To access a project and all its assigned experiments, select the projects corresponding “Project Icon”, “Project Title”, or “Arrow Icon” (C).

To delete a project, select the “Waste Bin Icon” (D). Select the “Pencil Icon” (E) to edit project details. This allows you to change the project name and its description.

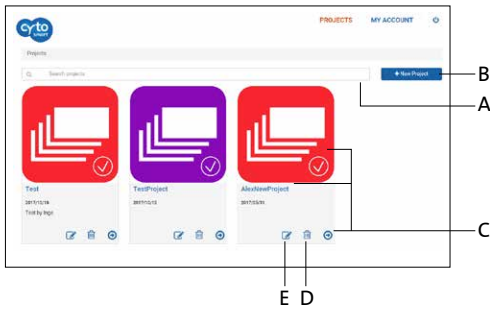

Figure 22. Project overview

Experiment Overview

After selecting a project (C), you will get access to an overview of all experiments assigned to that project (Figure 23). At the top, you can see an overview of the project data (F). As with the project overview, use the 'Search' bar (G) to find a specific experiment within a project.

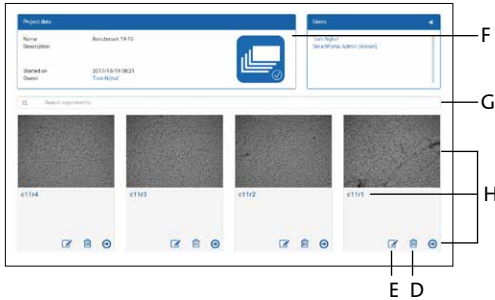

Figure 23. Overview of all experiments assigned

Select a specific experiment by clicking on its “Experiment Image”, “Experiment Title”, or the “Arrow Icon” (H). This will bring up the experiment page of that specific experiment.

To edit details of an experiment, select the “Pencil Icon” (E). This allows you to change the name and description of an experiment. To delete an experiment entirely, select the “Waste Bin Icon” (D).

Experiment Results

After you select a specific experiment, the data collected during that experiment will be presented in the Experiment Page (Figure 24). Below, you will find an overview of the panes in this Experiment Page.



Figure 24. Experiment page

Overview

1. Analyzed image
2. Experiment pane
3. Notes pane
4. Logbook pane

Analyzed Image

The analyzed image shows live cells within green circles and dead cells within red circles

Count

Image tab with the live and dead cells encircled by green and red circles.

Histogram

Histogram tab with histograms of the diameter of all counted live and dead cells.

Experiment Pane

The experiment pane provides an overview of the experiment (i.e., project start date, owner, number of cells, and viability).

The Images and Excel icon at top right of experiment pane allow downloading of Image set as a zip file and Excel as a .csv file.

At bottom left of image seen under Count tab is processed and raw icons. The processed file showing green and red live and dead cells identified can be downloaded as a .png file. The raw image before processing can also be downloaded as a .png file.

At bottom right of Histogram pane is .svg and .png icons for downloading the gating histogram.

Notes Pane

Notes that you have added after counting the cells are shown here. You can also add additional information regarding your experiment (e.g., passage number, experiment conditions, etc.). This information will be stored in the database with your experiment, including a date and time-stamp. To save notes, the user must click on the Save icon.

Logbook Pane

The logbook pane shows a log of all the changes made to the experiment.

6.0 Cleaning and Troubleshooting

Cleaning and Maintenance

The Corning® Cell Counter requires minimal cleaning for reliable operation. Unplug the USB cable before cleaning the device. Use a damp, lint-free wipe to clean the outer case with 70% ethanol or isopropanol.

If you see dust particles on the optical window, remove them by cleaning with a lint-free wipe.

Important: Do not autoclave the Corning Cell Counter, as this can result in damage to the electronics.

The Corning Cell Counter does not need regular maintenance. Do not perform any repairs or service on the device yourself. Contact Corning if a problem should arise via corning.support@cytosmart.com.

Troubleshooting

USB device does not connect The Corning Cell Counter can be connected via USB to various Windows computers, such as PC, laptop, or tablet. When receiving an error message (Figure 25), that the computer cannot communicate with USB devices, make sure that the USB cable is properly connected.

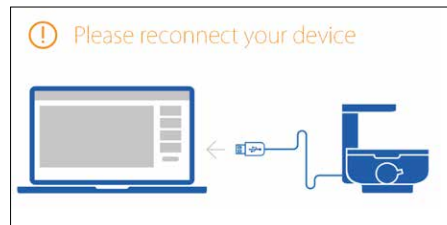

Figure 25. USB not connected

Also, with certain mobile Windows computers, such as laptops or tablets, connectivity problems with the Corning Cell Counter may arise. This is often due to a low battery. To resolve:

- ▶ Ensure the mobile Windows computer is connected to a working power source.
- ▶ Ensure the power source is functioning properly (e.g., check by plugging in another electrical device).
- ▶ Switch off the Windows computer. Unplug and reconnect all cables, and reboot the computer.

When using a hub connector, older versions might not provide enough power for the Corning Cell Counter to operate properly.

Troubleshooting (Continued)

No cells are visible

This may be due to cell concentration of the sample being below 5×10^4 cells/mL, which is below the operating range of the Corning® Cell Counter (Figure 26). To resolve this, pellet the solution by centrifuging and resuspend the cells in a smaller volume.

Another cause may be that the bulk sample solution has been left to stand for some time. Cells have then gravitated towards the bottom of the vial. By pipetting the suspension up and down before loading the counting chamber, you should obtain a homogenous cell suspension.

WARNING! This count is below our optimum counting range (5.0×10^4 cells/mL).

Figure 26. Warning message: not enough cells to count

Too many cells

This may be due to cell concentrations being above 1×10^7 cells/mL (Figure 27). Dilute your cell suspension to obtain a lower concentration and count again.

WARNING! This count is above our optimum counting range (1.0×10^7 cells/mL).

Figure 27. Warning message: too many cells to count

Cell clumps

Cells can aggregate into clumps, leading to false results when analyzed (Figure 28). When cell clumps are visible, prepare a new sample. By gently resuspending the stock cell suspension, aggregates can be broken down.

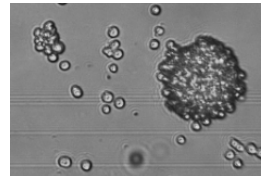

Figure 28. Cell clump example

Bubbles

While looking at the images in the CytoSMART™ application, you may see bubbles (Figure 29). They are recognizable as big black circles.

Bubbles can lead to false results, as they influence the distribution of cells and the volume inside the counting chamber. The cause for bubbles is often due to incorrect pipetting. Thus, make sure no air is included during pipetting a new sample.

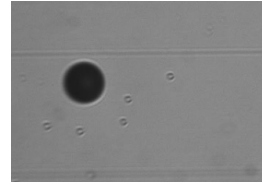

Figure 29. Air bubble example

Debris

When looking at the images from the CytoSMART application, you may see (cell) debris (Figure 30). This may be caused by not having properly cleaned the counting chamber. To resolve this, properly clean the counting chamber before loading a new sample.

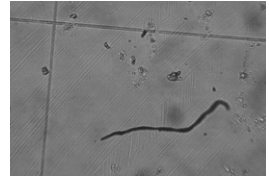

Figure 30. Debris present in the counting chamber

7.0 Technical Specifications

Counting Range	5 x 10 ⁴ to 1.0 x 10 ⁷ cells/mL
Counting Range	10 to 70 µm
Minimal System Requirements	Windows® 10 computer with internet access 2.4 GHz i5 CPU 4GB of RAM 128GB of free drive space USB 3 connection Internet connection Minimum monitor resolution 1280 x 720
Weight	1.0 kg
Power Supply	AC 100-240V, 2A, 10W, 50/60Hz
Field of View	2.0 x 1.5 mm
Magnification	200X
Image Resolution	2048 x 1536 pixels
Exported Formats	PNG
Light Source	LED
Camera	5 MP CMOS
Optical Filters	No optical filters
Unit Dimensions	122 x 122 x 125 mm (L x W x H)
Data Storage	Available upon request
Operating Environment	5°C to 40°C, 20% to 95% humidity
Cable Length	750 mm with option to extend with extra USB 3 cable

Accessories

Cat. No.	Description
480200	Corning® counting chamber

8.0 Limited Warranty

Corning Incorporated (Corning) warrants that this product will be free from defects in material and workmanship for a period of one (1) year from date of purchase. CORNING DISCLAIMS ALL OTHER WARRANTIES WHETHER EXPRESSED OR IMPLIED, INCLUDING ANY IMPLIED WARRANTIES OF MERCHANTABILITY OR OF FITNESS FOR A PARTICULAR PURPOSE. Corning's sole obligation shall be to repair or replace, at its option, any product or part thereof that proves defective in material or workmanship within the warranty period, provided the purchaser notifies Corning of any such defect. Corning is not liable for any incidental or consequential damages, commercial loss or any other damages from the use of this product.

This warranty is valid only if the product is used for its intended purpose and within the guidelines specified in the supplied instruction manual. This warranty does not cover damage caused by accident, neglect, misuse, improper service, natural forces or other causes not arising from defects in original material or workmanship. This warranty does not cover motor brushes, fuses, light bulbs, batteries or damage to paint or finish. Claims for transit damage should be filed with the transportation carrier.

In the event this product fails within the specified period of time because of a defect in material or workmanship, contact Corning Customer Service at: USA/Canada 1.800.492.1110, outside the U.S. +1.978.442.2200, visit www.corning.com/lifesciences, or contact your local support office.

Corning's Customer Service team will help arrange local service where available or coordinate a return authorization number and shipping instructions. Products received without proper authorization will be returned. All items returned for service should be sent postage prepaid in the original packaging or other suitable carton, padded to avoid damage. Corning will not be responsible for damage incurred by improper packaging. Corning may elect for onsite service for larger equipment.

Some states do not allow limitation on the length of implied warranties or the exclusion or limitation of incidental or consequential damages. This warranty gives you specific legal rights. You may have other rights which vary from state to state.

No individual may accept for, or on behalf of Corning, any other obligation of liability, or extend the period of this warranty.

For your reference, make a note of the serial and model number, date of purchase, and supplier here.

Serial No. _____ Date Purchased _____

Model No. _____

Supplier _____

9.0 Equipment Disposal



According to Directive 2012/19/EU of the European Parliament and of the Council of 4 July 2012 on waste electrical and electronic equipment (WEEE), the Corning® Cell Counter is marked with the crossed-out wheeled bin and must not be disposed of with domestic waste.



Consequently, the buyer shall follow the instructions for reuse and recycling of waste electrical and electronic equipment (WEEE) provided with the products and available at the following link: www.corning.com/weee

Appendix A: Trypan Blue Dilution Calculation and Histogram Gating for the Corning® Cell Counter

Two new features have been added to the Corning Cell Counter: The first allows you to select the Trypan blue dilution used and corrects the cell concentration(s) for the dilution used; the second is histogram gating. The features will be added automatically.

Trypan Blue Dilution Calculation

Performing a cell count has remained the same; you only need to select whether you have added Trypan blue in a 1:1 dilution to your sample when you are creating your experiment (Figure 1). You then focus on your cells. Live cells have bright centers with dark edges, whereas dead cells are completely black (Figure 2). Focus on your cells and press “Count.”

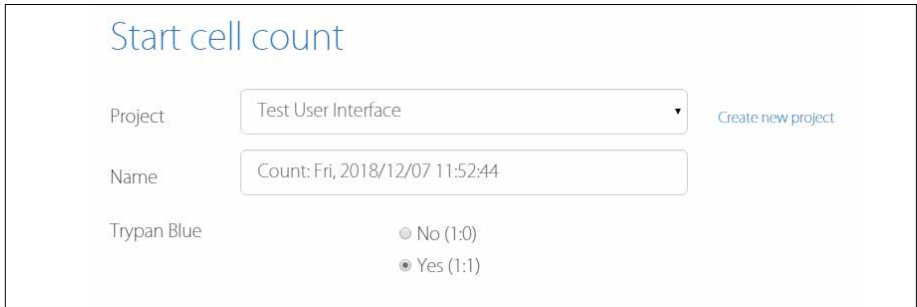

Figure 1. Name your experiment before starting a cell count and then select whether you have added Trypan blue to your cells or not. The default is “Yes (1:1).”

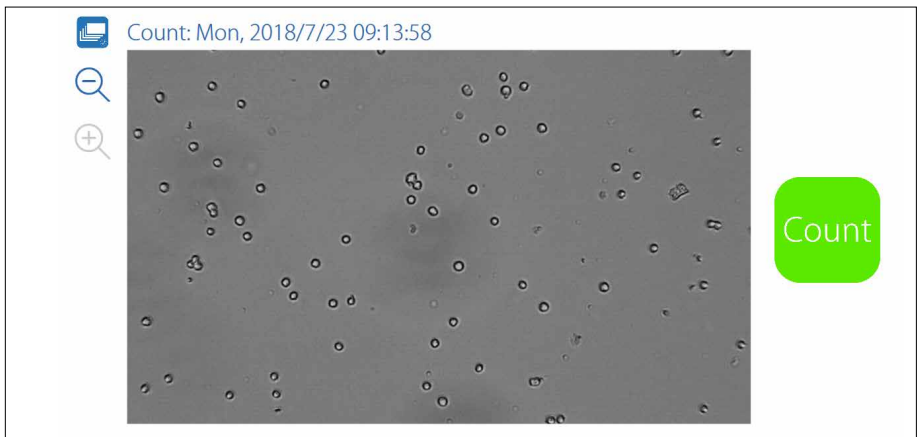

Figure 2. Focus on your cells before pressing “Count.”

On the Results page, you will notice some differences. On the previous results page (Figure 3), you had the option to view the counted image and the size histograms of the live and dead cells separately.

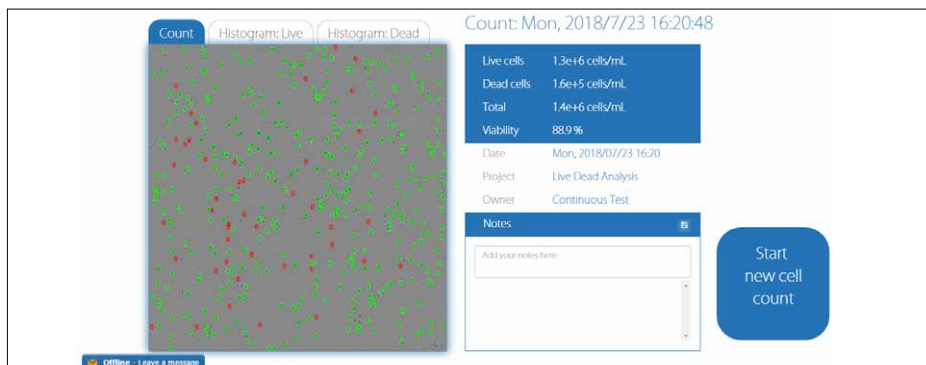

Figure 3. Previous Results page had three tabs to enable viewing of the count or one of the histograms.

In the new Results page (Figure 4), only two tabs are visible above the image:

1. **Count:** Image tab with the live and dead cells encircled by green and red circles.
2. **Histogram:** Histogram tab with histograms of the diameter of all counted live and dead cells.

By clicking on the “Histogram” tab, you will go to the new histogram panel.

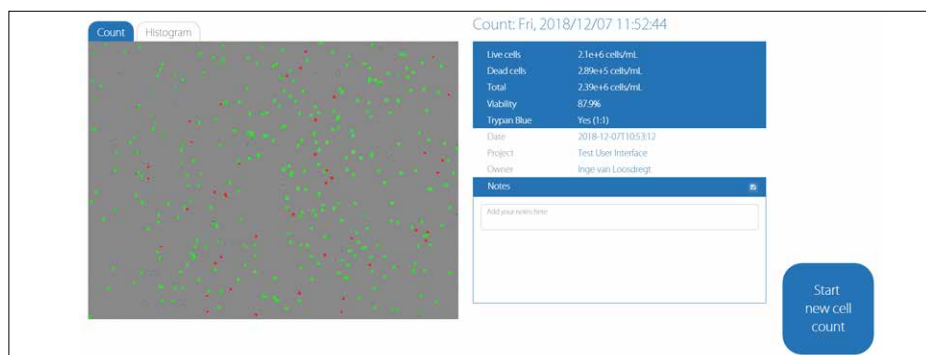

Figure 4. New results page. Click on the “Histogram” tab to view the histogram of the diameter of live and dead cells. The Trypan blue dilution is displayed in the results box.

The Trypan blue dilution that you have selected is displayed in the results box on the right (Figure 4). If you have used Trypan blue, the cell concentration that is displayed is corrected for the 1:1 dilution, so you no longer have to correct the results yourself. If you did not use Trypan blue, the results are not corrected for any dilution, as in the previous CytoSMART™ application.

Histogram Gating

In the new “Histogram” tab, the histograms of the live and dead cells are displayed in one chart (Figure 5). The black bars on the left and right side of the chart can be used to gate the histogram. Just click and drag the bars (Figure 6). You will notice that the concentration and viability of your count will adjust according to the position of the gates. These numbers are displayed below the histogram.

NOTE: Concentrations and viability displayed in the blue results box will always display the ungated results.



Figure 5. The size histograms of the live and dead cells are displayed in one chart. The histograms can be gated by moving the black bars on the left and right side of the chart.

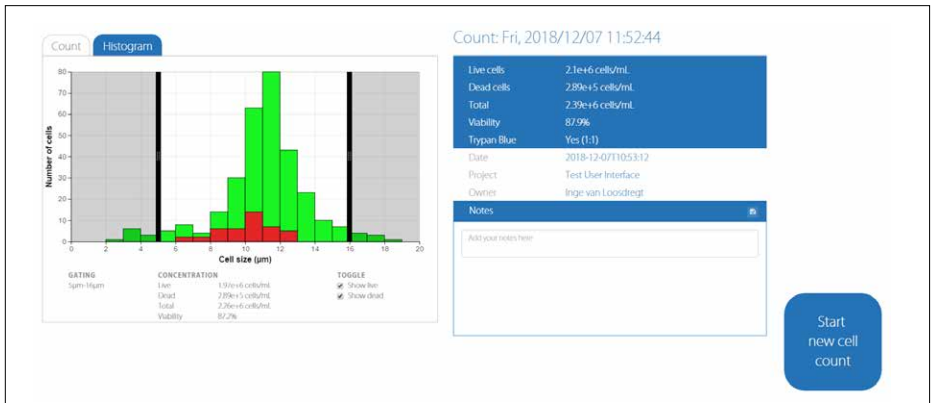

Figure 6. Example of gating the histograms. The cells that are in the shaded regions are excluded from the cell count. The cell concentrations and viability corresponding to the gated histograms are displayed underneath the histograms.

If you are only interested in the histogram of either the live or the dead cells, you can deselect the toggle box for one population (Figures 7 and 8). This can be done in both the gated and the ungated histograms.

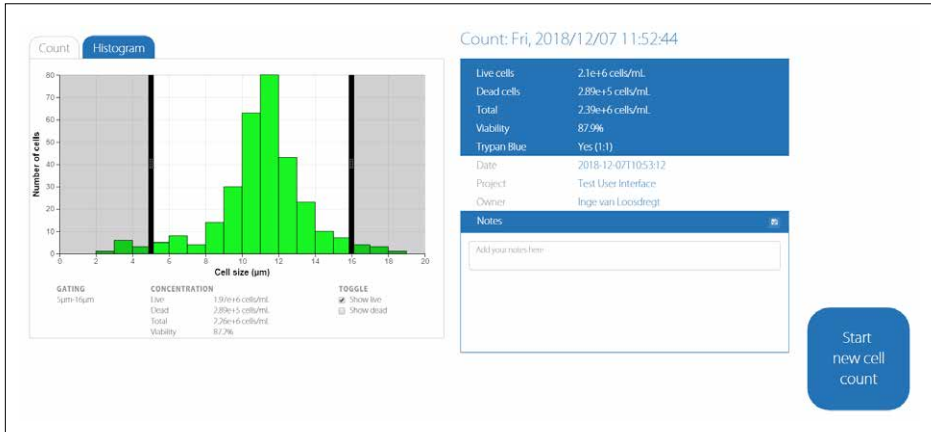

Figure 7. The dead cell population is deselected in the toggle box so that only the histogram of the live cells is displayed.

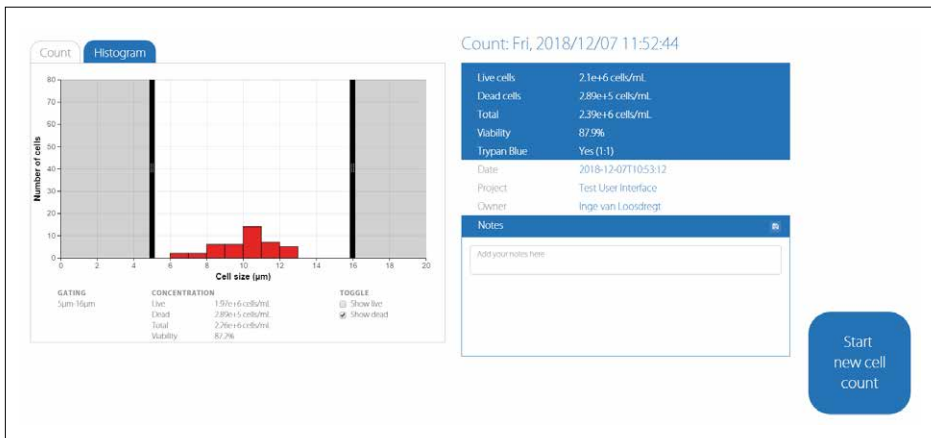

Figure 8. The live cell population is deselected in the toggle box so that only the histogram of the dead cells is displayed.

The gating of the histograms can also be performed on the CytoSMART™ Connect Cloud. Go to <https://cloud.cytosmart.com/> and log in using your credentials. Thereafter, open the project and then open the experiment. On the Experiment page, you will notice the same changes as in the CytoSMART application:

1. Two “Histogram” tabs have changed to one “Histogram” tab (Figures 9 and 10).
2. Your selection of Trypan blue addition [Yes (1:1) or No (1:0)] has been added to the Experiment box. The cell concentrations displayed in the Experiment box are corrected for the Trypan blue dilution that was used (1:1 or 1:0).

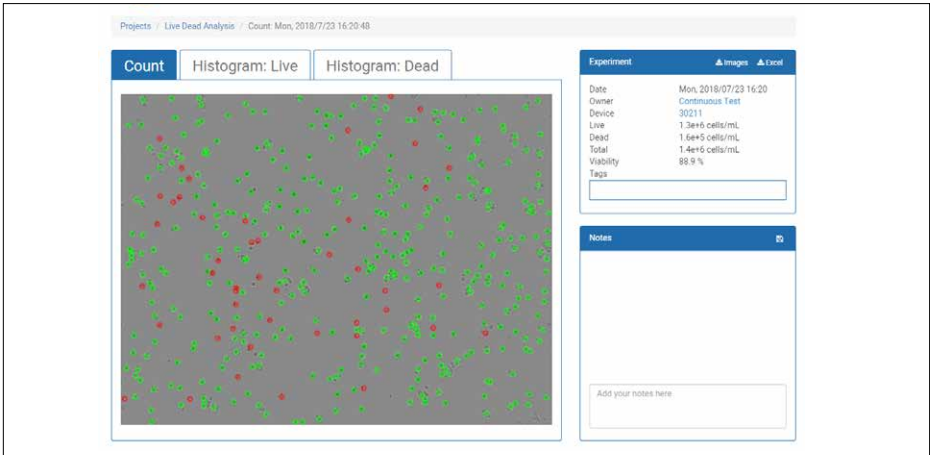

Figure 9. Previous Experiment page on the CytoSMART Connect Cloud had two “Histogram” tabs.

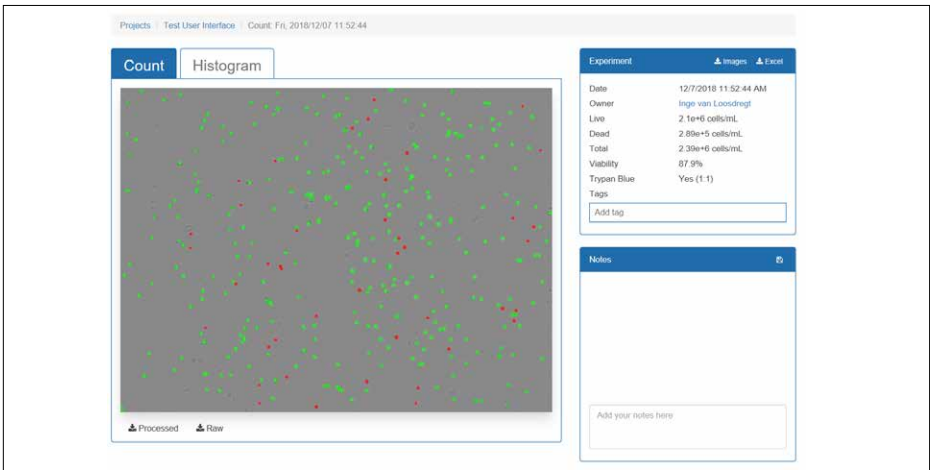

Figure 10. New Experiment page on the CytoSMART Connect Cloud has one “Histogram” tab and the Trypan blue selection in the Experiment box.

As with the CytoSMART™ application, click on the “Histogram” tab on the Experiment page to view the histograms of the live and dead cells (Figure 11), and gate the histograms. The gating can be done by clicking and sliding the black bars on the left or right side of the chart (Figure 12). The histogram can be downloaded as a .SVG or .PNG file by clicking one of the buttons on the bottom right below the histogram. The histogram will be downloaded in the current state. If you have gated the histogram, a gated histogram is downloaded.

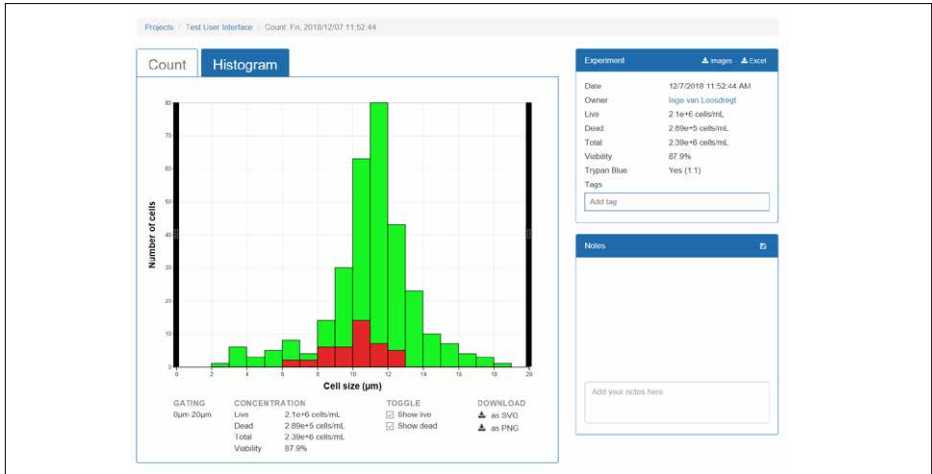

Figure 11. Click on the “Histogram” tab on the Experiment page to view the histograms of the diameter of the live and dead cells.

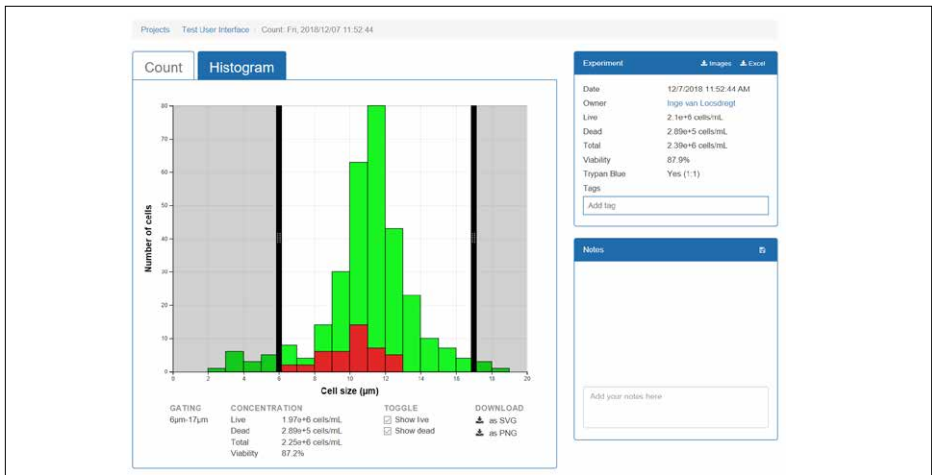

Figure 12. Click and slide the black bars on the left and right of the chart to gate the histograms. The cells in the shaded regions are excluded from the count. The cell concentration and viability corresponding to the gated histograms are displayed underneath the histograms.

Same as in the CytoSMART™ application, you can deselect one of the populations in the CytoSMART Connect Cloud environment (Figures 13 and 14). This can be done in both the gated and the ungated histograms. If you would like to download the histogram of only the live or dead cells, click on one of the download buttons on the bottom right while one of the histograms is deselected.

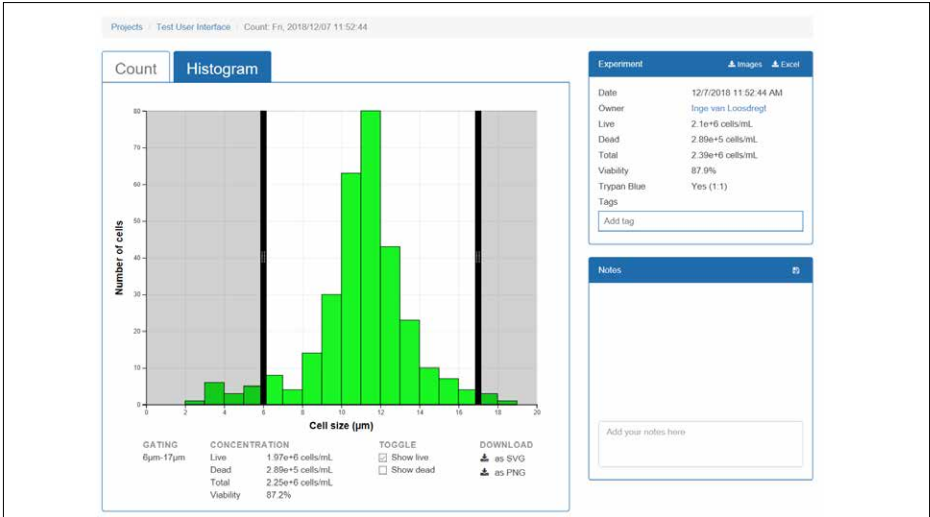

Figure 13. The dead cell population is deselected so only the histogram of the live cells is displayed.

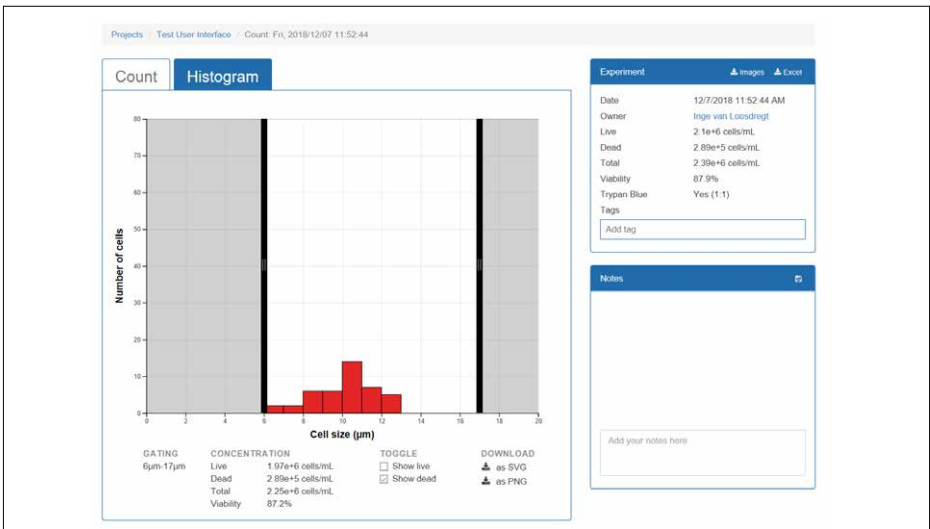

Figure 14. The live cell population is deselected so only the histogram of the dead cells is displayed.

Register your product warranty online at www.corning.com/lifesciences/warranty.

For more specific information on claims, visit the Certificates page at www.corning.com/lifesciences.

Warranty/Disclaimer: Unless otherwise specified, all products are for research use only. Not intended for use in diagnostic or therapeutic procedures. Corning Life Sciences makes no claims regarding the performance of these products for clinical or diagnostic applications.

For additional product or technical information, visit www.corning.com/lifesciences or call 800.492.1110. Outside the United States, call +1.978.442.2200 or contact your local Corning sales office.

CORNING

Corning Incorporated *Life Sciences*

836 North St.
Building 300, Suite 3401
Tewksbury, MA 01876
t 800.492.1110
t 978.442.2200
f 978.442.2476

www.corning.com/lifesciences

ASIA/PACIFIC

Australia/New Zealand

t 61 427286832

China

t 86 21 3338 4338
f 86 21 3338 4300

India

t 91 124 4604000
f 91 124 4604099

Japan

t 81 3-3586 1996
f 81 3-3586 1291

Korea

t 82 2-796-9500
f 82 2-796-9300

Singapore

t 65 6572-9740
f 65 6735-2913

Taiwan

t 886 2-2716-0338
f 886 2-2516-7500

EUROPE

CEurope@corning.com

France

t 0800 916 882
f 0800 918 636

Germany

t 0800 101 1153
f 0800 101 2427

The Netherlands

t 020 655 79 28
f 020 659 76 73

United Kingdom

t 0800 376 8660
f 0800 279 1117

All Other European Countries

t +31 (0) 206 59 60 51
f +31 (0) 206 59 76 73

LATIN AMERICA

grupoLA@corning.com

Brasil

t 55 (11) 3089-7400

Mexico

t (52-81) 8158-8400