

STREM

High Quality Chemicals for Research Since 1964



“METAL CATALYSTS FOR ORGANIC SYNTHESIS” WITH UPDATED REFERENCES
AVAILABLE AT STREM.COM

High Quality Specialty Chemicals

Strem Chemicals, Inc., established in 1964, is an employee-owned business, manufacturing and marketing specialty chemicals of high purity. Strem serves the academic community as well as research and development laboratories and commercial scale businesses which supply pharmaceutical, microelectronic, chemical and petrochemical products.

Strem Chemicals also provides custom synthesis and cGMP manufacturing services. Strem is an ISO 9001 certified company.

Strem Chemicals' corporate headquarters is located in Newburyport 38 miles (60km) north of Boston. This facility occupies 48,000 sq. ft. (4,460 m²). Its cGMP facility is FDA inspected. The European headquarters and warehouse are located in Bischheim, France.

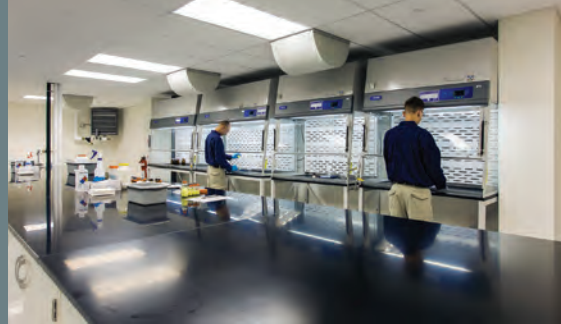
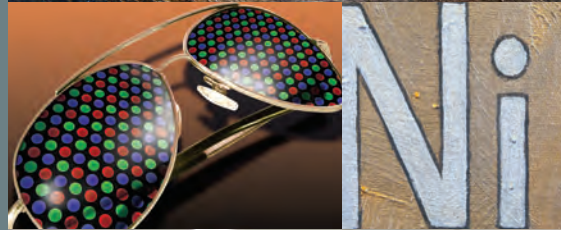



"We thank our customers for their business and look forward to contributing to their future successes"

– Mike Strem, founder and President of Strem Chemicals, Inc.



Strem Chemicals, Inc. is a member of SOCMA (Society of Chemical Manufacturers and Affiliates) and is committed to the ChemStewards® program.



Corporate Headquarters,
Newburyport, MA, U.S.A.

Expertise and Experience in Manufacturing

Strem Chemicals' mission is to provide specialty chemicals of high purity in a timely fashion. Quality is the most critical component of all products and services. We offer lot-to-lot traceability and a certificate of analysis for each lot.

Due to our focus on quality, most of our products are of high purity, typically 99%, with some at 99.9999% metals purity.

Our experience in handling allows for the safe packaging and shipping of hazardous materials as well as ones sensitive to air and moisture. We use a range of packaging containers including vials, bottles, ampoules, cylinders, bubblers and totes to name a few.

Packaging product in customer-supplied containers, such as CVD bubblers and ALD cylinders, is also possible. Strem is an ISO 9001 certified company.



STREM



We offer a variety of fine chemicals with a special emphasis on metals, inorganics, organometallics and nanomaterials.



We continue to make investments to improve our quality control capabilities.



Strem produces a technical publication, The Strem Chemiker, periodically which features technical articles from industry and academic scientists.

Custom Synthesis and cGMP

Our Catalog of Chemicals for Research provides access to a wide span of technical expertise which we utilize on custom synthesis projects.

Custom synthesis services and process development are conducted under the strictest confidence and often under secrecy agreements. Our customers include multi-billion dollar corporations, start-up businesses and university professors.

For pharmaceutical applications, manufacturing is conducted under current Good Manufacturing Practices (cGMP) in kilo-lab suites. Complete documentation is available, including validation and stability studies. Active Drug Master Files (DMF's) are also maintained.

Strem's cGMP facilities are FDA inspected.





The Newburyport facility contains four kilo-lab suites (including class 10,000) and are used to manufacture active pharmaceutical ingredients (API's) and intermediates.

cGMP manufacturing services have been available since 1988.



Reaction capabilities include:

- Alkylation
- Amination
- Ammonolysis
- Asymmetric synthesis
- Carbonylation
- Catalytic Reduction
- Chiral chemistry
- Dehydrogenation
- Formylation
- Hydroformylation
- Hydrogenation
- Liquid ammonia reactions
- Quaternization

Rapid Customer Service

Our large inventory helps us get products to you quickly. Most orders can be shipped the same day they are received. If same day shipment is not possible, we will provide expected shipping dates and keep you informed of the status of your order.

We pledge to provide technical service in a speedy and enthusiastic fashion to insure you have the products and information necessary for your project.

Our distribution partners worldwide share our goal of providing our high quality products with great service.



STREM



Our friendly employees are dedicated to providing great customer service. We also offer stock availability, product Safety Data Sheets and technical notes on our website, as well as a searchable catalog.

New product information is also available at www.strem.com.

DOT and UN approved bubbler configurations are available as well as precursor filling, refilling and cleaning services.

Product kits are available for customers performing screening experiments.

Innovative Products

We collaborate with academic and industrial innovators to make new technologies available to the research community around the world. This facilitates their commercial development and helps our customers achieve their goals.

We have used our expertise in organo-metallics and metal carbonyls to develop new metal-based nanomaterials. We have added quantum dots, surfactants for nanosynthesis and carbon-based products, such as graphene.

Our catalyst line has been expanded for metathesis, C-X coupling, C-C coupling, asymmetric hydrogenation, photocatalysis as well as other reactions. We have also added a range of biocatalysts, materials for battery applications and Metal Organic Framework products.

Our high purity precursor product line, including those for CVD and ALD applications, has also grown and new bubblers and cylinders have been added. DOT and UN approved configurations are now available as well as filling, refilling and cleaning services.

Many new products are introduced as a result of customer inquiries and suggestions.

If you don't find a product you need in our catalog, please ask us!



We sponsor the American Chemical Society Award for Distinguished Service in the Advancement of Inorganic Chemistry. Recent winners include: 2017 William B. Tolman, 2016 Vincent L. Pecoraro, 2015 Kim R. Dunbar.

We also sponsor the Canadian Society for Chemistry Award for Pure or Applied Inorganic Chemistry. Recent winners include: 2017 Dwight Seferos, 2016 Curtis P. Berlinguette, 2015 Muralee Murugesu.

STREM

Table of Contents

Glossary of Terms.....	ii
Placing Your Order.....	iii-xiii
Message from Management.....	xiv
Product Line Listing by Key Element.....	1-458
Biocatalysts.....	13-22
Ionic Liquids.....	81-84
Metal Scavenging Agents.....	128-134
MOFs and Ligands for MOF Synthesis.....	134-135
Molecular Sieves.....	135
Nanomaterials.....	138-167
Nanomaterials - Surfactants and Ligands for Nano Synthesis.....	167-169
Index of Kits.....	459-461
Kits.....	462-544
Listing of Kits: Biocatalysts, Catalysts & Organocatalysts, Ionic Liquids, Ligands, Metal Scavenging, Nanomaterials	
Formula Index.....	545-597
CAS Registry Index.....	598-610
Equipment.....	611-617
Cylinders & Adapters.....	611
CVD/ALD Cylinders.....	612
Electropolished Stainless Steel Bubbblers.....	613-616
Enzymatic Flow Reactor.....	617
Suba-Seal® Closures.....	617
Trademarks and Registered Trademarks.....	617

Products in this catalog are sorted according to their Key Element. We have also included individual sections to highlight certain product categories, such as Biocatalysts, Metal Organic Frameworks and Nanomaterials.

We are proud to be providing high quality specialty chemicals for research and development since 1964. Quality is paramount for all products and services that we offer. As part of our ongoing commitment to quality, we have achieved ISO 9001 certification for the Quality Management System (QMS) at our corporate headquarters.

Our booklets, which focus on applications and product classes, are available in print per request and also on our website. Below is a list of current booklet titles that are available. Please also check our Product Resources section online to find additional literature offerings, such as the Strem Chemiker, our technical publication, and product literature sheets.

- Buchwald Ligands and Precatalysts
- Gold Elements & Compounds
- Heterogeneous Catalysts
- Kits
- Materials for Energy Applications
- Metal Catalysts for Organic Synthesis
- MOCVD, CVD & ALD Precursors
- Nanomaterials
- New Products
- Other Ligands
- Phosphorous Ligands and Compounds
- PURATREM: High Purity Inorganics



Glossary of Terms

[α] _b	Specific rotation
AAS	Atomic Absorption Standard
ACS	Conforms to American Chemical Society specifications
air sensitive	Product may chemically react with atmospheric oxygen or carbon dioxide at ambient conditions. Handle and store under an inert atmosphere of nitrogen or argon.
amp	Ampouled
b.p.	Boiling point in °C at 760mm, unless otherwise noted
d.	Density
dec.	Decomposes
elec. gr.	Electronic Grade, suitable for electronic applications
f.p.	Flash point in °F
gran.	Granular
heat sensitive	Product may chemically degrade if stored for prolonged periods of time at ambient temperatures or higher. Store at 5°C or lower.
hydrate	Unspecified water content which may vary slightly from lot to lot
hygroscopic	Product may absorb water if exposed to the atmosphere for prolonged periods of time (dependent on humidity and temperature). Handle and store under an inert atmosphere of nitrogen or argon.
light sensitive	Product may chemically degrade if exposed to light
liq.	Liquid
m.p.	Melting point in °C
moisture sensitive	Product may chemically react with water. Handle and store under an inert atmosphere of nitrogen or argon.
NMR grade	Suitable as a Nuclear Magnetic Resonance reference standard
optical grade	For optical applications
pwdr.	Powder
primary standard	Used to prepare reference standards and standardize volumetric solutions
PURATREM	Product has a minimum purity of 99.99% (metals basis)
purified	A grade higher than technical, often used where there are no official standards
P. Vol.	Pore volume
pyrophoric	Product may spontaneously ignite if exposed to air at ambient conditions
reagent	High purity material, generally used in the laboratory for detecting, measuring, examining or analyzing other substances
REO	Rare Earth Oxides. Purity of a specific rare-earth metal expressed as a percentage of total rare-earths oxides.
SA	Surface area
store cold	Product should be stored at -18°C or 4°C, unless otherwise noted (see product details)
subl.	Sublimes
superconductor grade	A high purity, analyzed grade, suitable for preparing superconductors
tech. gr.	Technical grade for general industrial use
TLC	Suitable for Thin Layer Chromatography
v.p.	Vapor pressure mm of Hg
xtl.	Crystalline

About Purity

Chemical purity	is reported after the chemical name, e.g. Ruthenium carbonyl, 99%
Metals purity	is reported in parentheses with the respective element, e.g. Gallium (III) bromide, anhydrous, granular (99.999%-Ga) PURATREM where 100% minus the metal purity is equal to the maximum allowable percentage of trace metal impurity

Ordering - USA

*We continue to do all that we can to make ordering easy.
Our friendly, knowledgeable staff is always ready to help.*

PLACING YOUR ORDER

Call our Toll-Free Number available within the U.S.A. and Canada. Our Customer Service Specialists are on duty to take your orders between 8:00 a.m. & 5:00 p.m. Eastern Time.

If placing an order after 5:00 p.m. Eastern Time, you may leave a message on our voicemail system. Your order will be processed and shipped the next day if the material is in stock. We will contact you to confirm price and delivery time.



PHONE: 1-978-499-1600
Toll-Free # within the U.S.A. and Canada:
1-800-64-STREM (1-800-647-8736)



FAX: 1-978-465-3104
Toll-Free # within the U.S.A. and Canada:
1-800-51-STREM (1-800-517-8736)



MAIL TO: Strem Chemicals, Inc.
Dexter Industrial Park
7 Mulliken Way
Newburyport, MA 01950-4098



EMAIL: order@strem.com (product orders)
technical@strem.com (technical questions)
quotation@strem.com (special quote requests)
catalog@strem.com (catalog requests)
info@strem.com (all other inquiries)



WEBSITE: www.strem.com

QUOTATIONS: Submit requests by phone, email or via the searchable catalog on our website.

U.S.A. ORDERS: Domestic orders are handled through our headquarters in Newburyport, Massachusetts. Our telephone, fax and email contact information are listed above. There is no minimum order. All orders are welcome regardless of size or value.

FOREIGN ORDERS: In some geographical areas, we have foreign sales representatives. In those areas, it is more convenient to place orders directly through them. Please contact us for the names of both our stocking and non-stocking representatives in other countries. They are well qualified to handle your inquiries and process your orders.

PLEASE INCLUDE THE FOLLOWING WHEN PLACING YOUR ORDER:

- 6-digit Customer Account #
- Catalog Number
- Chemical Name/Product Description
- Quantity
- Unit size (metric units)
- Preferred Shipping Method
- Shipping Address

Ordering - USA

SAME DAY SHIPPING: All U.S.A. orders placed between 8:00 a.m. and 2:30 p.m. Eastern Time will be shipped the same day, except for those items that are not in stock.

We will ship them in the fastest, most economical way. All shipments are insured for your protection against loss or damage in transit unless you specify otherwise. When complete shipments cannot be sent, partial shipments will be made at our discretion, unless specifically directed otherwise at the time the order is placed.

METHODS OF SHIPPING: Below is a list of the shipping services available in the U.S.A., Canada, and to foreign destinations. Please inform us if you have a preferred means of shipping.

U.S.A. & Canada

FedEx Ground
FedEx Express
Freight Truck*
United Parcel Service (UPS)
U.S. Mail (USPS)

Foreign Destinations

Air Freight
DHL
FedEx Express
International Express Mail
Ocean Freight*

**Some items sold are particularly hazardous (extremely toxic or pyrophoric) and cannot be shipped via FedEx Ground, Air, UPS or Parcel Post. These items must ship via freight truck which may cause shipping charges to be higher than usual. Customers will be notified if an item requires shipment via truck and has the right to request an estimate of the shipping costs.*

***For foreign orders, hazardous items described above will require shipment via ocean freight as they cannot be shipped by air. Travel via ocean freight may have extended transit times as well as higher shipping costs. Customers will be notified if an item requires shipment via ocean freight and has the right to request an estimate of the shipping costs.*

SHIPPING RESTRICTIONS: Chemicals covered by 49 CFR, IATA and IMO shipping restrictions will be shipped accordingly. Any shipping restrictions that apply to a particular chemical are listed below the catalog number. An explanation of each is as follows:

HAZ This material is hazardous and cannot be shipped via mail or DHL.



For U.S.A. and Canada, this material must be shipped via freight truck.



For International Shipments, this material must be shipped via ocean freight.

PACKAGING: Air-sensitive materials are packaged under argon in wax-sealed bottles, in ampoules or in cylinders. We suggest that these materials be opened, used and stored under an inert atmosphere to maintain their integrity and ensure maximum shelf life. Products packaged in ampoules will be designated by the letters "amp" appearing below the catalog number.

SPECIAL PACKAGING: Special packaging may be required for the shipment of poisons (Division 6.1), or water-reactives (Division 4.3). We add a surcharge of \$14.00 per package for such shipments. We also apply a \$12.00 surcharge for materials requiring five-gallon shipping pails. We reserve the right to increase these charges as our cost for these special packaging materials increase. Other special packaging materials may also incur a surcharge.

PRICES: We reserve the right to make price changes at any time. In the event the price increase is more than ten percent (10%), we will contact the customer before shipment.

Quantities intermediate to the listed standard packages will be priced at the smaller standard package rate. Ampouled materials will be sold only in the listed standard sizes.

In the event the larger catalog units are temporarily out of stock, our order policy is to ship multiple smaller units at the reduced larger unit price. Ampouled materials are exempted from this policy and will be sold only at the listed catalog prices, but are eligible for multiple unit discounts.

We accept the following credit cards:



Ordering - USA

DISCOUNTS: Any product ordered in multiple lots, whether in standard, smaller-than-standard, or intermediate quantities is eligible for the following discounts:

5-9 units	Less 5% from catalog price
10-19 units	Less 10% from catalog price
20 or more units	Inquire

BULK QUANTITIES: Many of our products are available in bulk at substantially lower prices. Please contact our Sales Department for these special prices.

CUSTOM MANUFACTURING: Strem may be able to supply materials not listed in this catalog on a custom basis and would be pleased to evaluate your requirements.

cGMP MANUFACTURING: Current Good Manufacturing Practices (cGMP) kilo-lab facilities are available for pharmaceutical manufacturing. Complete documentation can be provided. Active Drug Master Files (DMFs) are maintained.

NOMENCLATURE: Strem Chemicals has adopted the systematic names recommended by IUPAC with Stock's designation (Roman numerals in parentheses) of oxidation states for most of our compounds. However, in some cases where a traditional name of commerce has become widely used and recognized, we have opted to use the common name. We have also retained the classical names for most organometallics.

The water of hydration of an inorganic product is expressed in the assigned product name using the terms mono-, di-, tri-hydrate, etc. Products having indefinite waters of hydration which may vary from lot to lot have been called "hydrate."

RETURN POLICY: If you wish to return an unopened product, we will do our best to accommodate your request. Please contact us first for a return material authorization number and specific shipping instructions.

There may be a 20% restocking charge, subject to a \$20.00 minimum, assessed on any unopened returned items. Of course, this charge will not apply to items returned due to a shipping error on our part.

TERMS: Our usual terms are net 30 days, FCA Newburyport, Massachusetts. Strem Chemicals also accepts VISA, Master Card and American Express for payment of orders.

GENERAL TERMS AND CONDITIONS: All sales are subject to our Standard Terms and Conditions available at www.strem.com.

Notice To Our Customers

All of the chemicals in this catalog are research chemicals as defined under the Toxic Substances Control Act. As such, they should be used or handled only by or under the direct supervision of "technically qualified individuals," as defined in 40CFR 710.3.

The chemical, physical and toxicological properties have not been fully investigated since these research chemicals are for investigational use only. Strem Chemicals, therefore, makes no guarantee of results and assumes no liability for injuries, damages or penalties resulting from their use, since the conditions of handling and use are beyond our control. Suggestions and recommendations for their use are not to be taken as a license to operate under or to infringe any patent.

Commande - Europe (Français)

*Nous faisons notre possible pour faciliter vos commandes.
Notre aimable personnel se tient à votre disposition pour vous aider.*



Tel.: (33) 03.88.62.52.60
Fax: (33) 03.88.62.26.81
Email: info.europe@strem.com
Website: www.strem.com

Strem Chemicals, Inc.
15, rue de l'Atome Z.I.
67800 BICHHEIM (France)

CONDITIONS DE VENTE

Toutes nos conditions de vente sont disponibles sur le site www.strem.com.

COMMENT PASSER VOS COMMANDES

Pour éviter toute erreur dans l'exécution de votre commande, veuillez mentionner le N° de référence indiqué sur le côté gauche du catalogue, le nom chimique du produit ainsi que la quantité désirée.

LES PRIX

Nous réservons le droit de modifier les prix à n'importe quel moment, si besoin est. Dans le cas où l'augmentation de prix serait supérieure à 10%, nous contacterons nos clients pour accord, avant livraison.

Pour les commandes de plusieurs unités d'un même produit, et quel qu'en soit le conditionnement, nous accordons les remises suivantes:

5 à 9 unités

10 à 19 unités

20 unités, et plus

remise de 5% sur le prix catalogue

remise de 10% sur le prix catalogue

veuillez nous interroger

BULK

La plupart de nos produits peuvent être fournis en grandes quantités à des prix avantageux. Veuillez consulter notre Service Commercial pour cotation. Ces demandes peuvent être transmises par fax, email ou par le biais de notre site internet www.strem.com.

VEUILLEZ PRÉCISER:

- le N° de référence du produit
- le nom chimique du produit
- la quantité
- l'unité
- votre code client si vous le connaissez
- votre N° de TVA (VAT)

SYNTHÈSE SUR MESURE

Nous avons également la possibilité de vous fournir certains produits ne figurant pas dans notre catalogue. Nous serons heureux de vous communiquer nos conditions.

Notre laboratoire GMP nous donne la possibilité de faire des synthèses pharmaceutiques sur mesure.

Les installations permettant la mise en oeuvre des techniques usuelles de fabrication de produits (cGMP) en laboratoire à l'échelle du kilogramme sont disponibles pour les fabrications pharmaceutiques. Une documentation complète peut être fournie sur demande. Les fichiers permanents actualisés de produits pharmaceutiques (DMF) sont maintenus.

DÉNOMINATION

Nous avons adopté les noms usuels, tels qu'ils sont recommandés par l'IUPAC, avec mention de consignes de stockage pour la plupart de nos produits. Cependant, dans le cas où un nom commun pour un produit serait entré en usage d'une manière très large, nous avons opté pour la dénomination du produit par son nom commun.

Commande - Europe (Français)

Nous avons également retenu les désignations classiques pour la plupart de nos composés organo-métalliques. L'eau d'hydratation d'un composé inorganique est désignée par : mono-, di-, tri-hydrate, etc., en regard du produit concerné.

Les produits incluant des eaux d'hydratation imparfaitement définies et susceptibles de variations d'un lot à l'autre, seront simplement désignés par "Hydrates".

EMBALLAGE

Les matériaux sensibles à l'air sont conditionnés sous Argon dans des bouteilles ou ampoules scellées à la cire.

Les produits conditionnés en ampoules seront suivis de l'abréviation "AMP" en dessous de notre N° de référence catalogue.

Nous suggérons que ces produits soient ouverts, utilisés et stockés en atmosphère inerte, afin de leur maintenir leurs propriétés et leur assurer la plus longue conservation possible.

LIVRAISONS

Les commandes sont traitées à réception et expédiées au plus vite.

Les commandes de produits n'étant pas disponibles en totalité, feront l'objet d'une expédition partielle sur demande.

MODE DE TRANSPORT:

HAZ Ces produits ne sont pas acceptés par la poste



Livraison par transporteur spécial

FRAIS DE TRANSPORT

LIVRAISON EN FRANCE:

Les livraisons ne nécessitant pas de transport spécial et dont le montant est supérieur à 150€ net HT seront gratuites.

Pour toute commande inférieure à ce montant, une participation de 10€ sera demandée. Les livraisons nécessitant un transport spécial seront à la charge de l'acheteur après information et accord.

A la réception, veuillez à comparer le contenu du colis avec le bulletin de livraison et nous signaler toute différence le plus tôt possible.

RETOUR DE MARCHANDISES

Veuillez-nous contacter pour accord et instructions concernant le renvoi. Les produits devront nous être retournés dans leur emballage d'origine et non ouverts.

PAIEMENT:

Lors de vos paiements veuillez préciser le numéro de facture.

Nos conditions de paiement sont : 30 jours net.

Les marchandises restent notre propriété jusqu'au paiement intégral de la facture.

LIEU DE JURIDICTION: STRASBOURG

Note Importante

Tous les produits figurant dans ce catalogue sont destinés à la recherche, selon la définition figurant dans le TSCM.

Ils ne pourront être utilisés ou manipulés que par des personnes dûment habilitées, ou sous le contrôle strict d'un technicien qualifié.

Les effets chimiques, physiques et toxiques, n'ont encore pu être déterminées clairement puisqu'il s'agit de produits destinés à la recherche. Leurs propriétés ne pourront être constatées qu'ultérieurement.

De ce fait, STREM CHEMICALS ne peut offrir aucune garantie quant aux résultats, et ne peut en aucun cas être tenu pour responsable pour d'éventuels dommages, blessures, détériorations, etc., qui pourraient résulter de la manipulation des produits étant donné qu'elle s'effectue sous votre responsabilité.

Les suggestions et recommandations que nous fournissons quant à leur usage ne sont données qu'à titre purement indicatif, et ne devront en aucun cas servir à enfreindre la réglementation, dans le cas d'un produit protégé par un dépôt de brevet.

Bestellung - Europa (Deutsch)

*Wir bemühen uns, Ihnen das Bestellen so einfach wie möglich zu machen.
Sollten Sie Fragen haben, steht Ihnen unser freundliches Personal gerne jederzeit zur Verfügung.*



Tel.: 07851/75879
Fax: 00 33 3.88.62.26.81 Fr.
Email: info.europe@strem.com
Website: www.strem.com

Strem Chemicals, Inc.
15, rue de l'Atome Z.I.
67800 BICHHEIM
(Frankreich)

oder

Strem Chemicals, Inc.
Postfach 1215
77672 KEHL
(Deutschland)

VERKAUFSBEDINGUNGEN

Die geltenden Verkaufsbedingungen finden Sie auf www.strem.com.

PREISE UND ZAHLUNG

Die Preise verstehen sich in Euro inklusive Innen und Außenverpackung.

Bei Zahlungen bitte geben Sie die Rechnungsnummer an.

Aufgrund der sich ständig ändernden Marktsituation insbesondere hinsichtlich der Preise von Lieferanten aus anderen Währungsgebieten, die bei Kursschwankungen entsprechend angepaßt werden, sind die Preise freibleibend.

Rechnungen werden nur durch uns gestellt und sind ausschließlich an uns zu bezahlen.

Unsere Rechnungen werden sofort nach Rechnungseingang fällig und können innerhalb von 30 Tagen nach Lieferung bezahlt werden.

Die nicht rechtzeitige Zahlung einer Lieferung oder begründete Zweifel an der Zahlungsfähigkeit oder Kreditwürdigkeit des Bestellers können wir zum Anlaß nehmen, sämtliche Forderungen gegen den Besteller sofort fällig zu stellen und weitere Lieferungen nur gegen Vorkasse zu erbringen.

Der Besteller ist nicht berechtigt, gegenüber unseren fälligen Zahlungsansprüchen ein Zurückbehaltungsrecht geltend zu machen; er kann gegenüber unseren Forderungen nur mit unbestrittenen oder rechtskräftig festgestellten Forderungen aufrechnen.

MENGENRABATTE

Für fünf bis neun Packungen des gleichen Produktes gewähren wir 5% Rabatt, für zehn bis neunzehn Packungen 10% Rabatt auf den derzeit gültigen Katalogpreis. Bei größeren Mengen bitten wir um Ihre Anfrage.

BULKMENGEN

Viele unserer Produkte können wir auch in Großpackungen zu niedrigeren Preisen anbieten. Bitte erkundigen Sie sich bei uns nach diesen Sonderpreisen. Wir bitten um Ihre Anfrage per fax, email oder über unserer Webseite www.strem.com.

UM FEHLER ZU VERMEIDEN BESTELLEN SIE BITTE UNTER ANGABE:

- der Artikelnummer
- der Einheit
- des Chemikaliennamens
- der Kunden Nr. wenn bekannt
- der Menge
- der Ust. Id. Nr

KUNDENSYNTHESE

Viele nicht in diesem Katalog aufgeführten Verbindungen können wir als Kundensynthese herstellen. Unser Schwerpunkt liegt im Bereich der metallorganischen Synthese. Bitte fragen Sie bei Bedarf nach unseren Möglichkeiten. Für die Herstellung pharmazeutischer Produkte im kg-Masstab haben wir ein cGMP-Labor (Current Good Manufacturing Practices) verfügbar.

Bestellung - Europa (Deutsch)

NOMENKLATUR

Für die meisten unserer Produkte haben wir die systematischen Namen übernommen, wie sie von der IUPAC empfohlen werden. Wenn jedoch Trivialnamen üblich und gebräuchlich sind, haben wir diese verwendet. Für die meisten metallorganischen Verbindungen haben wir ebenfalls die in der Fachliteratur üblichen Bezeichnungen übernommen. Der Kristallwassergehalt bei anorganischen Salzen wird durch den Zusatz "mono-, di-, trihydrate" usw. ausgedrückt. Produkte mit unbestimmten oder wechselnden Kristallwassergehalt werden nur als "Hydrate" bezeichnet.

VERPACKUNG

Luftempfindliche Produkte sind unter Argon oder Stickstoff in verwachsten oder in Ampullen verpackt. Diejenigen unserer Produkte, die in Ampullen verpackt sind, werden im vorliegenden Katalog mit den Buchstaben "Amp." unterhalb der Katalog-nummer bezeichnet. Wir empfehlen, diese Produkte nur unter inert Gasatmosphäre zu öffnen und zu benützen, um eine Zersetzung oder gefährliche Reaktionen zu vermeiden. Ansonsten sind unsere Produkte handelsüblich verpackt.

LIEFERUNG

Bei Bestellungen von Chemikalien, die nicht vollständig verfügbar sind, können wir auf Anfrage Teillieferungen durchführen.

Gefahrguthinweise:

HAZ Gefahrgut - kein Versand per Post möglich



Spezialtransport

Lieferung innerhalb von Deutschland:

Die Lieferungen, die keinen besonderen Transport benötigen und einen Betrag von 150€ netto übersteigen, werden frei Haus geliefert. Bei Bestellungen unter diesem Betrag, wird eine Gebühr in Höhe von 10€ erhoben.

Die Gebühren für die Lieferungen, die einen besonderen Transport benötigen, werden dem Einkäufer nach Informationen und Zustimmung weiterberechnet.

Lieferung in anderen Ländern:

Der Besteller wird mit den entsprechenden Frachtkosten belastet ausgenommen es besteht eine besondere Vereinbarung.

VERSAND

Besondere Versandwünsche des Bestellers berücksichtigen wir, soweit dies im Rahmen der gesetzlichen Vorschriften gestattet ist. Mehrkosten für Eillieferungen gehen zulasten des Bestellers.

Die Gefahr des zufälligen Untergangs und der zufälligen Verschlechterung der Ware geht mit der Absendung der Ware oder ihrer Auslieferung an den Versandbeauftragten, spätestens aber mit Verlassen des Werkes oder des Lagers auf den Besteller über. Ist für den Versand eine besondere Weisung des Bestellers abzuwarten, geht die Gefahr auf diesen mit der Anzeige der Versandbereitschaft über.

Beim Wareneingang, bitten wir Sie den Inhalt des Pakets mit dem Lieferschein zu vergleichen und einen Unterschied so schnell wie möglich zu melden.

WARENRÜCKSENDUNG

Bitte kontaktieren Sie uns für die Genehmigung und Anweisungen auf die Rückkehr. Die Produkte müssen in ihrer Originalverpackung und ungeöffnet zurückgeschickt werden.

Bestellung - Europa (Deutsch)

AUSSCHLUß VON SCHADENERSATZANSPRÜCHEN

Die chemischen, physikalischen und toxikologischen Eigenschaften vieler unserer Produkte sind noch nicht vollständig erforscht, da diese Forschungskemikalien ausschließlich für wissenschaftliche Zwecke bestimmt sind. Die Prüfung, ob ein bestimmtes Produkt für die Verwendung des Bestellers geeignet ist, obliegt alleine diesem. Die Verantwortung für die Anwendung im medizinischen Bereich, im Haushalt, als Futtermittel oder Lebensmittelzusatz liegt allein beim Besteller. Für Verletzungen oder Unfälle, die durch die Lagerung oder Handhabung unserer Produkte entstehen, übernehmen wir keine Haftung, da sie außerhalb unserer Kontrolle liegen. Technische Informationen geben wir gerne weiter. Doch können wir keine Verantwortung für die Ergebnisse des Kunden übernehmen.

Sämtliche Schadenersatzansprüche des Bestellers (einschließlich aller Ansprüche auf Ersatz von Aufwendungen, Kosten etc.), insbesondere wegen Leistungsverzugs, Unvermögens oder Unmöglichkeit, wegen des Fehlens zugesicherter Eigenschaften, positiver Forderungsverletzungen, Verschuldens bei Vertragsabschluß, wegen jeglicher Erklärungen oder unterlassener Erklärungen unsererseits oder wegen unerlaubter Handlung (einschließlich etwaiger Produzentenhaftung), insbesondere auch Ansprüche auf Ersatz von Schäden, Kosten und Aufwendungen, die nicht an den Produkten selbst entstanden sind (Folgeschäden), sind ausgeschlossen, es sei denn sie beruhen auf Vorsatz oder grober Fahrlässigkeit. Soweit von uns Schadenersatz verlangt werden kann, sind wir nur verpflichtet, den bei Vertragsabschluß vorhersehbaren Schaden zu ersetzen.

EIGENTUMSVORBEHALT

Die Ware bleibt bis zur vollen Bezahlung sämtlicher Forderungen einschließlich Nebenforderungen, künftig entstehende Forderungen und Einlösungen von Scheck und Wechseln unser Eigentum.

RECHT UND GERICHTSSTAND

Straßburg - Frankreich

Wichtiger Hinweis

Alle Produkte in diesem Katalog sind für die Forschung bestimmt, gemäß der Definition in der TSCM.

Sie dürfen nicht von dazu ermächtigten Personen oder unter der strengen Aufsicht eines qualifizierten Techniker verwendet oder verarbeitet werden.

Die chemischen, physikalischen und toxisch, doch konnte nicht eindeutig bestimmt werden, da sie für die Forschung bestimmt ist. Ihre Eigenschaften können erst später erkannt werden.

Daher kann Strem Chemicals keinerlei Garantie bezüglich der Ergebnisse bieten, und kann in keiner Weise für Schäden verantwortlich gemacht werden, Verletzungen, Schäden, etc., die vom Umgang mit Produkten führen kann, da es wird unter Ihrer Verantwortung.

Die Vorschläge und Empfehlungen, die wir für die Nutzung zur Verfügung stellen werden nur zur Information angegeben und wird durch ein Patent geschützt, die Vorschriften im Falle eines Produkts zu verletzen auf keinen Fall verwendet werden.

Ordering - UK

*We continue to do all that we can to make ordering easy.
Our friendly, knowledgeable staff is always ready to help.*

All UK orders should be directed to:



Tel.: +44 1 223 873028
Fax: +44 1 223 870207
Email: enquiries@strem.co.uk
Website: www.strem.co.uk

Strem Chemicals UK Ltd.
Newton Hall
Town Street
Newton, Cambridge
CB22 7ZE

QUOTATIONS: Submit requests by email, fax or via our website.

MINIMUM ORDER: No minimum order is required. All orders are welcomed regardless of size or value. Low value orders may incur a small packing and delivery charge.

HOW TO ORDER: Please order by both chemical name and catalogue number to ensure receipt of the product you want. Also please specify the quantity and the size in metric units. Orders received in non-metric lots will be processed to the nearest listed metric lot.

DELIVERY: Typically, we can deliver items next day, if in stock in the UK. We receive two shipments per week for stock available at Strem USA. This offers a lead time of 3-5 working days for delivery depending on the day that an order is placed. Drop shipment is available at an additional cost if a faster service is required. Contact us for estimates. Please check the website for estimated delivery times. (Lead times listed on the website does not apply for chemicals which need to be shipped via ocean freight. Please contact us for more details on these items.)

SHIPPING RESTRICTIONS:

HAZ This material is hazardous and cannot be shipped by mail.



In the UK this material must be shipped by freight truck.



For international shipments, this material must be shipped by ocean freight.

PLEASE INCLUDE THE FOLLOWING WHEN PLACING YOUR ORDER:

- Customer Account #
- Catalogue Number
- Chemical Name/Product Description
- Quantity
- Unit size (metric units)
- Preferred Shipping Method
- Shipping Address

PACKAGING: Air sensitive materials are packaged under argon in a wax-sealed bottle, ampoule or in cylinders. Those products packaged in an ampoule will be designated by the letters "amp" appearing below the catalogue number. We suggest that these materials be opened, used and stored in an inert atmosphere to maintain their integrity and ensure maximum shelf life.

SPECIAL PACKAGING: Certain chemicals, such as poisons and highly flammable materials require special packaging. We reserve the right to charge for these costs dependent on the order value.

PRICES: We reserve the right to make price changes at any time. Prices will be reviewed in the event that there is a significant change in exchange rate or base costs. Please check website for up-to-date pricing. We will always contact the customer prior to shipment in the event of a difference in price between the customer's order and the website.

Ordering - UK

Quantities intermediate to the listed standard packages will be priced at the smaller standard package rate. Ampouled materials will only be sold in the standard packages.

In the event the larger catalogue units are temporarily out of stock, our order policy is to ship multiple smaller units at the reduced larger price. However ampouled materials are exempted from this policy and will be sold only at the listed catalogue prices, but are subject to multiple unit discounts.

We accept the following credit cards:



DISCOUNTS: Any product ordered in multiple lots, whether in standard, smaller-than-standard or intermediate quantities is eligible for the following discounts:

5-9 units

10-19 units

20 or more units

Less 5% from catalogue price

Less 10% from catalogue price

Inquire

BULK QUANTITIES: Many of our products are available at substantially lower prices. Please contact us for these special prices.

CUSTOM MANUFACTURING: Strem Chemicals may be able to supply materials not listed in this catalogue on a custom basis and would be pleased to evaluate your requirements.

cGMP MANUFACTURING: Current Good Manufacturing Practices (cGMP) kilo-lab facilities are available for pharmaceutical manufacturing. Complete documentation can be provided. Active Drug Master Files (DMFs) are maintained.

NOMENCLATURE: Strem Chemicals has adopted the systematic names adopted by IUPAC with Stock's designation (Roman numeral in parentheses) of oxidation states for most of our compounds. However, in some cases where a traditional name of commerce has become widely used and recognized, we have opted to use the common name. We have also retained the classical name for most organometallics.

The water of hydration of an inorganic product is expressed in the assigned product names using the terms mono-, di-, tri-hydrate etc. Products having indefinite waters of hydration which may vary from lot to lot have been called simply "hydrate".

RETURN SHIPMENTS: If you wish to return a product we will do our best to accommodate you. Please contact us first for return permission and shipping instructions. Unless we are aware that you are returning an item and expect your shipment, it could be misdirected and lost.

There may be a 20% restocking charge, subject to a £20 minimum, assessed on any unopened items. Of course this charge will not apply to items returned due to a shipping error on our part.

TERMS: Our usual terms are net 30 days, F.O.B. Cambridge. We also accept Visa and Mastercard for payment of orders.

Notice To Our Customers

All of the chemicals in this catalogue are research chemicals as defined under the United States Toxic Substances Control Act, and hazard identified via GHS/CLP regulations. As such, they should be used or handled only by or under the direct supervision of "technically qualified individuals," in accordance with national regulations such as COSHH, 40CFR 710.3 etc.

The chemical, physical and toxicological properties have not been fully investigated since these research chemicals are for investigational use only. Strem Chemicals, therefore, makes no guarantee of results and assumes no liability for injuries, damages or penalties resulting from their use, since the conditions of handling and use are beyond our control. Suggestions and recommendations for their use are not to be taken as a license to operate under or to infringe any patent.

Message from Management

We are here to support you as you solve your technical challenges.

STREM ACHIEVES ISO 9001 CERTIFICATION

Strem's corporate headquarters, located in Newburyport, Massachusetts, has achieved ISO 9001 certification for Quality Management System (QMS) standard.

NEW NANOMATERIALS

Strem launched nanomaterials manufacturing activities in 2004. Since then we have continued to expand our range and have added many new metal-nanoparticles and graphene quantum dots.

As an employee-owned company we wish to thank our customers for their loyalty which has contributed to our continued success.

CATALYSTS AND LIGANDS AVAILABLE AT MULTI-KILO SCALE

We have added new ligands and metal catalysts for organic synthesis, C-C, C-X bond formation, asymmetric and transfer hydrogenation, metathesis and other transformations. Through licensing agreements we are able to offer patented products, many at kilo- scale.

BIOCATALYSTS COMPLEMENT OUR METAL CATALYST OFFERING

We have partnered with industry leaders to offer proprietary biocatalysts for research and development.

CUSTOM SYNTHESIS AND cGMP MANUFACTURING SERVICES

Companies from Fortune 500 to small start-ups have engaged Strem's custom synthesis and cGMP services. For GMP products, Strem maintains regulatory filings in over twenty countries and hosted an FDA inspection in 2016. Customer audits are always welcome. We are also capable of handling high-potency materials. In addition, we have expanded our kilo-lab capacity as well as the range of our analytical test capabilities

COMMITMENT TO HIGHER EHS&S STANDARDS AND COMMUNITY.

Strem adheres to the Society of Chemical Manufacturers and Affiliates (SOCMA) ChemStewards® program. We received their Performance Improvement Award for outstanding commitment to continuous improvement of Environmental, Health, Safety & Security practices for the past five years. In addition, Strem has qualified for the ChemStewards® Excellence Tier, which is the program's highest ranking for successful efforts to go above and beyond the minimum for federal environmental, health, safety and security (EHS&S) compliance, build customer confidence and community trust, and strengthen product stewardship.

CVD & ALD EQUIPMENT AND PRECURSOR LINE CONTINUES TO GROW

Additional precursors for CVD/ALD have been added to our product line. In addition, more bubbler configurations for chemical vapor deposition and cylinders for atomic layer deposition are now available. The range of services offered has been expanded to include cleaning and filling of precursors. Some precursors have been exclusively licensed by Strem for commercial applications and have been implemented by our customers.

OTHER NEW PRODUCTS?

We welcome your suggestions for new products.

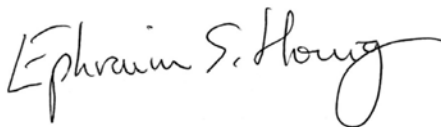

Ephraim S. Honig, Ph.D., M.B.A.
Chief Executive Officer



ALUMINUM (Elemental Forms)

13-0025	Aluminum foil (99.5%) (7429-90-5) Al; FW: 26.98; 0.0254 mm thick, 30 cm x 30 cm; m.p. 660°; b.p. 2056°; d. 2.702	5pcs 25pcs
93-1379	Aluminum foil (99.9%) (7429-90-5) Al; FW: 26.98; 0.5 mm thick x 50 mm wide; m.p. 660°; b.p. 2056°; d. 2.702	100 x 50mm 500 x 50mm
93-1313	Aluminum foil (99.997%) (7429-90-5) Al; FW: 26.98; 0.25 mm thick; m.p. 660°; b.p. 2056°; d. 2.702	50 x 50mm 100 x 100mm
93-1372	Aluminum foil (99.9995%) (7429-90-5) Al; FW: 26.98; 0.127 mm thick x 100 mm wide; m.p. 660°; b.p. 2056°; d. 2.702	50 x 100mm 250 x 100mm
13-0026	Aluminum ingot (99.999%) (7429-90-5) Al; FW: 26.98; metal ingot; m.p. 660°; b.p. 2056°; d. 2.702	100g 500g
93-1316 HAZ	Aluminum powder (99+%)(7429-90-5) Al; FW: 26.98; 20-40 mesh gran.; m.p. 660°; b.p. 2056°; d. 2.702	500g 2kg
93-1344 HAZ	Aluminum powder (99.7%) (7429-90-5) Al; FW: 26.98; -325 mesh; m.p. 660°; b.p. 2056°; d. 2.702	500g 2kg
13-0036	Aluminum rod (99+%)(7429-90-5) Al; FW: 26.98; 12.7mm dia. x 30cm long (~102.5g/30cm); m.p. 660°; b.p. 2056°; d. 2.702	2 x 30cm 10 x 30cm
13-0038	Aluminum rod (99.9995%) (7429-90-5) Al; FW: 26.98; 6.4mm dia. (~4.34g/5cm); m.p. 660°; b.p. 2056°; d. 2.702	5cm 25cm
13-0044	Aluminum shot (99.999%) (7429-90-5) Al; FW: 26.98; 6.35 x 6.35 mm cylinders; m.p. 660°; b.p. 2056°; d. 2.702	25g 100g
13-0048	Aluminum wire annealed (99.999%) (7429-90-5) Al; FW: 26.98; 0.5mm dia. (~0.53g/m); m.p. 660°; b.p. 2056°; d. 2.702	10m 50m

ALUMINUM (Compounds)

13-0750	α-Alumina, 99.5+% (1344-28-1) Al_2O_3 ; FW: 101.96; 28-48 mesh gran.; SA: 0.04 m ² /g; P.Vol. 0.015 cc/g	500g 2kg
13-1000	α-Alumina trihydrate, 65% Al_2O_3, 34.8% H_2O, 0.15% Na_2O (1344-28-1) $Al_2O_3 \cdot 3H_2O$ or $Al(OH)_3$; FW: 156.01; white powdr.	500g 2kg
13-2525	gamma-Alumina, min. 97% (1344-28-1) Al_2O_3 ; FW: 101.96; white powdr.; SA: ~185m ² /g; P.Vol. 0.43cc/g	500g 2kg
13-2610	gamma-Alumina, low soda (1344-28-1) Al_2O_3 ; FW: 101.96; 1/4" x 1/4" white pellets; SA: 145m ² /g	500g 2kg
13-2528	gamma-Alumina, 1/16" spheres (1344-28-1) Al_2O_3 ; FW: 101.96; white spheres	500g 2kg
93-1301	Aluminum acetate, basic (boric acid adduct) (7360-44-3) $Al(OH)_2(OOCCH_3) \cdot XH_3BO_3$; FW: 120.04; white powdr. (contains ~2% Na) <i>moisture sensitive</i>	100g 500g
93-1302	Aluminum acetylacetonate, 99% (13963-57-0) $Al(CH_3COCHCOCH_3)_3$; FW: 324.31; white powdr.; m.p. 192-193°; b.p. dec. 320° (subl. 150°/1mm)	100g 500g
93-1385 HAZ	Aluminum bromide, 99% (7727-15-3) $AlBr_3$; FW: 266.71; white to off-white lumps; m.p. 97.5°; b.p. 268°; d. 2.64 <i>moisture sensitive</i>	50g 250g
93-1308 HAZ	Aluminum s-butoxide, 98% (2269-22-9) $Al(OC_4H_9)_3$; FW: 246.33; colorless liq.; b.p. 200-206°/30 mm; f.p. 82°F; d. 0.9671 <i>moisture sensitive</i>	100g 450g
93-1386 HAZ	Aluminum carbide, 98% (1299-86-1) Al_4C_3 ; FW: 143.96; -325 mesh brown powdr.; m.p. 2100°; d. 2.36 <i>moisture sensitive</i>	25g 100g
13-0050 HAZ	Aluminum chloride, anhydrous (99.99+%-Al) PURATREM (7446-70-0) $AlCl_3$; FW: 133.34; -20 mesh white to yellow powdr.; m.p. 190°; b.p. 180° subl.; d. 2.44 <i>moisture sensitive</i>	50g 250g
93-1387 HAZ	Aluminum chloride, anhydrous, reagent, 99% (7446-70-0) $AlCl_3$; FW: 133.34; white to yellow powdr.; m.p. 190°; b.p. 180° subl.; d. 2.44 <i>moisture sensitive</i>	250g 1kg

ALUMINUM (Compounds)

93-1309 HAZ	Aluminum chloride hexahydrate, reagent, 99% (7784-13-6) AlCl ₃ ·6H ₂ O; FW: 133.34 (241.43); white xtl.; m.p. 100° dec.; d. 2.398 <i>hygroscopic</i>	250g 1kg
13-1309 HAZ	Aluminum chloride hexahydrate (99.999%-Al) PURATREM (7784-13-6) AlCl ₃ ·6H ₂ O; FW: 133.34 (241.43); white xtl.; m.p. 100° dec.; d. 2.398 <i>hygroscopic</i>	25g 100g
13-1310 HAZ	Aluminum chloride hexahydrate (99.9995%-Al) PURATREM (7784-13-6) AlCl ₃ ·6H ₂ O; FW: 133.34 (241.43); white xtl.; m.p. 100° dec.; d. 2.398 <i>hygroscopic</i>	25g 100g
93-1370 HAZ	Aluminum ethoxide, 99% (555-75-9) Al(OC ₂ H ₅) ₃ ; FW: 162.17; white chunks; m.p. 130°; b.p. 210°/10 mm <i>moisture sensitive</i>	25g 100g
93-1326	Aluminum 2-ethylhexanoate, basic, min. 96% (30745-55-2) AlOH[OOCCH(C ₂ H ₅)C ₄ H ₉] ₂ ; FW: 330.41; white powder; f.p. >350°F	100g 500g
93-1312	Aluminum fluoride, anhydrous, 98.5% (7784-18-1) AlF ₃ ; FW: 83.98; white powder; m.p. 1291° subl. <i>moisture sensitive</i>	10g 50g
13-0075	Aluminum fluoride, anhydrous, 99+% (7784-18-1) AlF ₃ ; FW: 83.98; white powder; m.p. 1291° subl. <i>moisture sensitive</i>	10g 50g
13-0200	Aluminum hexafluoroacetylacetonate, min. 98% (15306-18-0) Al(CF ₃ COCHOCOCF ₃) ₃ ; FW: 648.169; white to off-white xtl.; m.p. 70-73°; b.p. dec. 170° (subl. 50°/0.1mm) <i>moisture sensitive</i>	5g 25g
93-1317	Aluminum hydroxide, dried gel, 99% (21645-51-2) Al(OH) ₃ ; FW: 78.00; white powder; d. 2.42	500g 2kg
93-1389 HAZ	Aluminum iodide, 95% (7784-23-8) AlI ₃ ; FW: 407.69; tan to red-brown powder; m.p. 191°; b.p. 360°; d. 3.98 <i>moisture sensitive</i>	10g 50g
93-1319	Aluminum lactate, min. 95% (18917-91-4) Al(C ₃ H ₅ O ₃) ₃ ; FW: 294.20; white powder.	100g 500g
93-1325 HAZ	Aluminum nitrate nonahydrate, 98+% (ACS) (7784-27-2) Al(NO ₃) ₃ ·9H ₂ O; FW: 212.99 (375.14); white xtl.; m.p. 73.5° <i>hygroscopic</i>	100g 500g 2kg
13-1377	Aluminum nitride, agglomerated powder (24304-00-5) AlN; FW: 40.99; avg. 2.5-4.0 micron gray powder. (99% < 50 microns) <i>moisture sensitive</i>	100g 500g
93-1377	Aluminum nitride, agglomerated powder, high purity (24304-00-5) AlN; FW: 40.99; avg. 2.5-4.0 micron gray powder. (99% < 50 microns); d. 3.26 <i>moisture sensitive</i>	100g 500g
13-1378	Aluminum nitride, degglomerated powder, high purity (24304-00-5) AlN; FW: 40.99; 1.0-15.0 micron gray powder. <i>moisture sensitive</i>	100g 500g
13-1300	Aluminum oxide (99.999%-Al) PURATREM (1344-28-1) Al ₂ O ₃ ; FW: 101.96; white powder; b.p. 2980°; d. 3.97	10g 50g
93-1329	Aluminum oxide, activated, acidic, gamma, 96% (1344-28-1) Al ₂ O ₃ ; FW: 101.96; -60 mesh white powder; SA: 150m ² /g; m.p. 2045°; b.p. 2980°; d. 3.97	500g 2kg
93-1334	Aluminum oxide, activated, basic, gamma, 96% (1344-28-1) Al ₂ O ₃ ; FW: 101.96; -60 mesh white powder; SA: 150m ² /g; m.p. 2045°; b.p. 2980°; d. 3.97	500g 2kg
93-1338	Aluminum oxide, activated, neutral, gamma, 96% (1344-28-1) Al ₂ O ₃ ; FW: 101.96; -60 mesh white powder; SA: 150m ² /g; m.p. 2045°; b.p. 2980°; d. 3.97	500g 2kg
13-1400	Aluminum oxide nanopowder (1344-28-1) See page 138	
93-1339	Aluminum oxide, 1-5 micron powder, 99+% (1344-28-1) Al ₂ O ₃ ; FW: 101.96; white powder; m.p. 2045°; b.p. 2980°; d. 3.97	250g 1kg

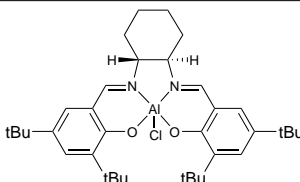

ALUMINUM (Compounds)

13-1315 NEW	Aluminum oxide powder, surface area 6 m²/g, 99% (Grade APS 1 micron) (1344-28-1) Al ₂ O ₃ ; FW: 101.96; white solid	250g 1kg
93-1340 HAZ	Aluminum perchlorate nonahydrate, reagent (81029-06-3) Al(ClO ₄) ₃ ·9H ₂ O; FW: 325.33 (487.47); white xtl.; d. 2.0 <i>hygroscopic</i>	50g 250g
93-1345 HAZ	Aluminum i-propoxide, 98+% (555-31-7) Al[OCH(CH ₃) ₂] ₃ ; FW: 204.25; white powdr.; m.p. 118.5°; b.p. 140.5°/8 mm; d. 1.0346 <i>moisture sensitive</i>	250g 1kg
97-0139 HAZ	Aluminum i-propoxide (99.99+% Al) PURATREM (555-31-7) Al[OCH(CH ₃) ₂] ₃ ; FW: 204.25; white powdr.; m.p. 118.5°; b.p. 140.5°/8 mm; d. 1.0346 <i>moisture sensitive</i>	25g 100g
13-1346	Aluminum selenide, min. 95% (99.5% Al) (1302-82-5) Al ₂ Se ₃ ; FW: 290.84; red to black pieces, 6.5mm and down; d. 3.437 <i>moisture sensitive</i>	1g 5g 25g
93-1348	Aluminum silicate dihydrate, 98% (1332-58-7) Al ₂ O ₃ ·2SiO ₂ ·2H ₂ O; FW: 222.13 (258.16); white powdr.	500g 2kg
93-1349	Aluminum stearate (637-12-7) Al(C ₁₈ H ₃₅ O ₂) ₃ ; FW: 877.42; white powdr.; m.p. 103°; d. 1.010	1kg 5kg
93-1350	Aluminum sulfate octadecahydrate, 98+% (ACS) (7784-31-8) Al ₂ (SO ₄) ₃ ·18H ₂ O; FW: 342.15 (666.41); colorless xtl.; m.p. 86.5° dec.; d. 1.69 <i>moisture sensitive</i>	500g 2kg
93-1353 HAZ	Aluminum sulfide (99+% Al) (1/4" and down pieces) (1302-81-4) Al ₂ S ₃ ; FW: 150.16; gray pieces; m.p. 1100°; d. 2.02 <i>moisture sensitive</i>	5g 25g
13-1500	Aluminum trifluoromethanesulfonate, 99% (Aluminum triflate) (74974-61-1) Al(CF ₃ SO ₃) ₃ ; FW: 474.18; white powdr.; m.p. dec. <i>hygroscopic</i>	10g 50g
13-5800	(1R,2R)-(-)-[1,2-Cyclohexanediamino-N,N'-bis(3,5-di-t-butylsalicylidene)]aluminum(III) chloride, 98% (250611-13-3) [C ₃₆ H ₅₂ N ₂ O ₂] ₂ AlCl; FW: 607.26; yellow powdr.; m.p. 250-255° For detailed technical note visit strem.com .	1g 5g
13-5801	(1S,2S)-(+)-[1,2-Cyclohexanediamino-N,N'-bis(3,5-di-t-butylsalicylidene)]aluminum(III) chloride, 98% (307926-51-8) [C ₃₆ H ₅₂ N ₂ O ₂] ₂ AlCl; FW: 607.26; yellow powdr.; m.p. >350°	1g 5g



Technical Note:

- See 13-5800 (page 3)

93-1397 HAZ 	Di-i-butylaluminum chloride, 97% (1779-25-5) (C ₄ H ₉) ₂ AlCl; FW: 176.67; colorless liq.; d. 0.905 <i>moisture sensitive, pyrophoric</i>	100g 500g
93-1355 HAZ 	Di-i-butylaluminum hydride (20% in hexanes) (1191-15-7) (C ₄ H ₉) ₂ AlH; FW: 142.22; colorless liq.; f.p. -9°F (hexane); d. 0.70 <i>moisture sensitive, pyrophoric</i> Note: Free rubber septum included.	100g 500g
93-1356 HAZ 	Diethylaluminum chloride, 97% (96-10-6) (C ₂ H ₅) ₂ AlCl; FW: 120.56; colorless liq.; m.p. -85°; f.p. -1°F; d. 0.961 <i>moisture sensitive, pyrophoric</i>	100g 225g
13-1600 HAZ	Dimethylaluminum i-propoxide, 98% (99.99% Al) PURATREM (6063-89-4) (CH ₃) ₂ Al(OC ₃ H ₇); FW: 116.14; colorless liq.; d. 0.824 <i>air sensitive, moisture sensitive</i>	1g 5g









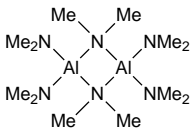

Technical Note:

- Useful starting material for the atomic layer deposition of Al₂O₃ films.

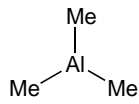
References:

- J. Vac. Sci. Tech. A., **2003**, *21*, 1366

ALUMINUM (Compounds)

13-4500	Hexakis(dimethylamino)dialuminum 98% (99.9%-Al) TDMAA (32093-39-3) $C_{12}H_{36}Al_2N_6$; FW: 318.42; white to yellow pwdr.; m.p. 82-84°; d. 0.865 <i>air sensitive, moisture sensitive</i>		1g 5g 25g
93-1358 HAZ 	Tri-i-butylaluminum, min. 95% (100-99-2) $(C_4H_9)_3Al$; FW: 198.33; colorless liq.; m.p. 4°; b.p. 73°/5 mm; d. 0.781 <i>moisture sensitive, pyrophoric</i>		100g 225g
13-1850 HAZ 	Triethylaluminum, min. 93% (97-93-8) $(C_2H_5)_3Al$; FW: 114.17; colorless liq.; m.p. -52.5°; b.p. 186°; f.p. -1°F; d. 0.835 <i>moisture sensitive, pyrophoric</i>		25g 100g 500g
98-1855 HAZ 	Triethylaluminum, elec. gr. (99.999+%-Al) PURATREM (97-93-8) $(C_2H_5)_3Al$; FW: 114.17; colorless liq.; m.p. -52.5°; b.p. 186°; f.p. -1°F; d. 0.835 <i>moisture sensitive, pyrophoric</i>		100g
13-1900 HAZ	Triethyl(tri-sec-butoxy)dialuminum (contains diethyl(tetra-sec-butoxy)dialuminum and tetraethyl(di-sec-butoxy)dialuminum) $(C_2H_5)_3Al_2(OC_4H_9)_3$; colorless liq.; b.p. 183-186°/40mm <i>air sensitive, moisture sensitive</i>		25g 100g
Technical Note: 1. Non-pyrophoric precursor for the chemical vapor deposition of aluminum oxide.			
93-1360 HAZ 	Trimethylaluminum, min. 98% (75-24-1) $(CH_3)_3Al$; FW: 72.09; colorless liq.; m.p. 15.4°; b.p. 20°/8 mm; f.p. 1.4°F; d. 0.752 (20°) <i>moisture sensitive, pyrophoric</i> Note: Available prepacked in ALD cylinder- see 98-4003, 98-4004.		100g 225g
98-4003 HAZ 	Trimethylaluminum, min. 98%, 93-1360, contained in 50 ml Swagelok® cylinder (96-1070) for CVD/ALD (75-24-1) $(CH_3)_3Al$; FW: 72.09; colorless liq.; m.p. 15.4°; b.p. 20°/8 mm; f.p. 1.4°F; d. 0.752 (20°) <i>moisture sensitive, pyrophoric</i> Note: High temperature Swagelok® cylinder assembly 96-1071 available at extra cost. See 98-4004.		10g 25g
98-4004 HAZ 	Trimethylaluminum, min. 98%, 93-1360, contained in high-temp 50 ml Swagelok® cylinder (96-1071) for CVD/ALD (75-24-1) $(CH_3)_3Al$; FW: 72.09; colorless liq.; m.p. 15.4°; b.p. 20°/8 mm; f.p. -1°F; d. 0.752 (20°) <i>moisture sensitive, pyrophoric</i>		25g
98-1955 HAZ 	Trimethylaluminum, elec. gr. (99.999+%-Al) PURATREM (75-24-1) $(CH_3)_3Al$; FW: 72.09; colorless liq.; m.p. 15.4°; b.p. 20°/8 mm; f.p. 1.4°F; d. 0.752 (20°) <i>moisture sensitive, pyrophoric</i> Note: Available prepacked in ALD cylinder- see 98-4007, 98-4008.		25g 100g 200g
98-4008 HAZ 	Trimethylaluminum, elec. gr. (99.999+%-Al) PURATREM, 98-1955, contained in 50 ml Swagelok® cylinder (96-1070) for CVD/ALD (75-24-1) $(CH_3)_3Al$; FW: 72.09; colorless liq.; m.p. 15.4°; b.p. 20°/8 mm; f.p. 1.4°F; d. 0.752 (20°) <i>moisture sensitive, pyrophoric</i>		25g
98-4007 HAZ 	Trimethylaluminum, elec. gr. (99.999+%-Al) PURATREM, 98-1955, contained in 50 ml electropolished Swagelok® cylinder (96-1077) for CVD/ALD (75-24-1) $(CH_3)_3Al$; FW: 72.09; colorless liq.; m.p. 15.4°; b.p. 20°/8mm; f.p. 1.4°F; d. 0.752 (20°) <i>moisture sensitive, pyrophoric</i>		25g

ALUMINUM (Compounds)

13-5000	Tris(2,2,6,6-tetramethyl-3,5-heptanedionato)aluminum, 99% (99.9%-Al) [Al(TM-HD)₃] (14319-08-5) Al(C ₁₁ H ₁₉ O ₂) ₃ ; FW: 576.80; white xtl.; m.p. 255-258°; b.p. dec. >400° (subl. 150°/0.01mm)	1g 5g 25g
---------	---	-----------------

AMMONIUM (Compounds)

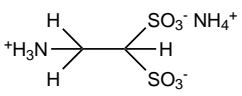
93-0201	Ammonium acetate, anhydrous, 97+% (ACS) (631-61-8) NH ₄ OOCCH ₃ ; FW: 77.08; white xtl.; m.p. 114°; d. 1.17 <i>moisture sensitive</i>	500g 2kg
02-0570	Ammonium 2-aminoethane-1,1-disulfonic acid hydrate, min. 95% (1235825-84-9) C ₂ H ₁₀ N ₂ O ₆ S ₂ ; FW: 222.24; white powdr.; m.p. 57-60° For detailed technical note visit strem.com .	1g 5g
		
93-5803	Ammonium cerium(IV) nitrate, 98.5+% (ACS) (16774-21-3) (NH ₄) ₂ Ce(NO ₃) ₆ ; FW: 548.23; orange xtl.	100g 500g
93-0208	Ammonium chloride, 99.5+% (ACS) (12125-02-9) NH ₄ Cl; FW: 53.49; white gran.; m.p. 340° subl.; b.p. 520°; d. 1.527	500g 2kg
93-0242	Ammonium chloride (99.999%) PURATREM (12125-02-9) NH ₄ Cl; FW: 53.49; white xtl.; m.p. 340° subl.; b.p. 520°; d. 1.527	25g 100g
93-2902	Ammonium copper(II) chloride dihydrate (10060-13-6) CuCl ₂ ·2NH ₄ Cl·2H ₂ O; FW: 241.43 (277.46); blue xtl.; m.p. 110°; d. 1.993	100g 500g
93-0221	Ammonium dihydrogen phosphate, 98+% (ACS) (7722-76-1) NH ₄ H ₂ PO ₄ ; FW: 115.03; white powdr.; m.p. 190°; d. 1.803	250g 1kg
02-0500	Ammonium dihydrogen phosphate (99.998%) PURATREM (7722-76-1) NH ₄ H ₂ PO ₄ ; FW: 115.03; white xtl.; m.p. 190°; d. 1.803	10g 50g
93-4201	Ammonium dimolybdate, 99% (27546-07-2) (NH ₄) ₂ Mo ₂ O ₇ ; FW: 339.95; white powdr.	100g 500g
93-0212	Ammonium fluoride, 98+% (ACS) (12125-01-8) NH ₄ F; FW: 37.04; white xtl.; m.p. subl.; d. 1.009 <i>moisture sensitive</i>	100g 500g
76-0080	Ammonium hexabromoosmate(IV), 99% (24598-62-7) (NH ₄) ₂ OsBr ₆ ; FW: 705.70; black powdr.	1g 5g
77-0019	Ammonium hexachloroiridate(III) hydrate (~39% Ir) (15752-05-3) (NH ₄) ₃ IrCl ₆ ·XH ₂ O; FW: 459.06; olive green powdr.	1g 5g
77-0020	Ammonium hexachloroiridate(IV), 99% (16940-92-4) (NH ₄) ₂ IrCl ₆ ; FW: 441.00; black xtl.; m.p. dec.; d. 2.856 <i>hygroscopic</i>	1g 5g
93-4601	Ammonium hexachloropalladate(IV), 99+% (19168-23-1) (NH ₄) ₂ PdCl ₆ ; FW: 355.20; red xtl.; m.p. dec.; d. 2.418 <i>hygroscopic</i>	1g 5g
93-7801	Ammonium hexachloroplatinate(IV), 99% (16919-58-7) HAZ (NH ₄) ₂ PtCl ₆ ; FW: 443.89; yellow powdr.; m.p. dec.; d. 3.065 <i>hygroscopic</i>	1g 5g
45-0035	Ammonium hexachlororhodate(III) hydrate (15336-18-2) (NH ₄) ₃ RhCl ₆ ·XH ₂ O; FW: 369.74; dark red xtl. <i>hygroscopic</i>	250mg 1g
02-0590	Ammonium hexachlororhodate(III) monohydrate (99.995%-Rh) PURATREM (15336-18-2) (NH ₄) ₃ RhCl ₆ ·H ₂ O; FW: 369.74 (387.76); red xtl. <i>hygroscopic</i>	1g 5g
44-0020	Ammonium hexachlororuthenate(IV), 99% (18746-63-9) (NH ₄) ₂ RuCl ₆ ; FW: 349.87; red to brown xtl. <i>hygroscopic</i>	1g 5g
93-2655	Ammonium hexacyanoferrate(II) hydrate (14481-29-9) (NH ₄) ₄ Fe(CN) ₆ ·XH ₂ O; FW: 284.11; yellow to green powdr.	25g 100g
93-1395	Ammonium hexafluoroaluminate, min. 98% (7784-19-2) (NH ₄) ₃ AlF ₆ ; FW: 195.09; white powdr.	10g 50g

AMMONIUM (Compounds)

93-3201	Ammonium hexafluorogermanate, 99% (16962-47-3) (NH ₄) ₂ GeF ₆ ; FW: 222.66; white powder; d. 2.564	5g 25g
93-1502 HAZ	Ammonium hexafluorophosphate, 99% (16941-11-0) NH ₄ PF ₆ ; FW: 163.00; white xtl.; m.p. dec.; d. 2.180 <i>hygroscopic</i>	25g 100g
93-1476 HAZ	Ammonium hexafluorosilicate, min. 98% (16919-19-0) (NH ₄) ₂ SiF ₆ ; FW: 178.14; white powder; m.p. dec.	500g 2kg
93-2202	Ammonium hexafluorotitanate(IV), min. 98% (16962-40-6) (NH ₄) ₂ TiF ₆ ; FW: 197.97; white xtl.	25g 100g
93-0205 HAZ	Ammonium hydrogen fluoride, min. 96% (contains 3-4% NH₄F) (1341-49-7) NH ₄ F·HF; FW: 57.04; white flake; m.p. 125.6°; d. 1.50 <i>hygroscopic</i>	500g 2kg
93-0220	Ammonium hydrogen phosphate, 98+% (ACS) (7783-28-0) (NH ₄) ₂ HPO ₄ ; FW: 132.06; white powder.	250g 1kg
93-0214	Ammonium iodide (99.999%) PURATREM (12027-06-4) NH ₄ I; FW: 144.94; white xtl.; m.p. 551° subl.; d. 2.514	5g 25g
93-2650	Ammonium iron(II) sulfate hexahydrate, 98.5+% (ACS) (7783-85-9) Fe(NH ₄) ₂ (SO ₄) ₂ ·6H ₂ O; FW: 284.05 (392.16); light green powder; m.p. 100-110° dec.; d. 1.864	500g 2kg
93-7420	Ammonium metatungstate hydrate (99.9+%·W) (12028-48-7) (NH ₄) ₆ H ₂ W ₁₂ O ₄₀ ·XH ₂ O; FW: 2956.45; white powder.	25g 100g
93-2301 HAZ	Ammonium metavanadate, 99% (7803-55-6) NH ₄ VO ₃ ; FW: 116.98; off-white powder; m.p. 200° dec.; d. 2.33	100g 500g
02-0700 HAZ	Ammonium metavanadate (99.995%-V) PURATREM (7803-55-6) NH ₄ VO ₃ ; FW: 116.98; white powder; m.p. 200° dec.; d. 2.33	5g
02-0745	Ammonium molybdate tetrahydrate (99.98%-Mo) (12027-67-7) (NH ₄) ₆ Mo ₇ O ₂₄ ·4H ₂ O; FW: 1163.80 (1235.86); white powder; d. 2.498	100g 500g 2kg
02-0750	Ammonium molybdate tetrahydrate (99.999%-Mo) PURATREM (12027-67-7) (NH ₄) ₆ Mo ₇ O ₂₄ ·4H ₂ O; FW: 1163.80 (1235.86); white xtl.; d. 2.498	5g 25g
93-0245	Ammonium molybdate tetrahydrate (ACS) (12027-67-7) (NH ₄) ₆ Mo ₇ O ₂₄ ·4H ₂ O; FW: 1163.80 (1235.86); white powder; d. 2.498	100g 500g
93-0216 HAZ	Ammonium nitrate, 99.5% (6484-52-2) NH ₄ NO ₃ ; FW: 80.04; white xtl.; m.p. 169.6°; d. 1.725	500g 2kg
93-0249 HAZ	Ammonium perrhenate, 99+% (13598-65-7) NH ₄ ReO ₄ ; FW: 268.24; white powder; m.p. dec.; d. 3.97	1g 5g 25g
02-0900 HAZ	Ammonium perrhenate (99.999%-Re) PURATREM (13598-65-7) NH ₄ ReO ₄ ; FW: 268.24; white powder; m.p. dec.; d. 3.97	1g 5g
93-0248	Ammonium phosphomolybdate hydrate, reagent (54723-94-3) (NH ₄) ₃ PO ₄ ·12MoO ₃ ·XH ₂ O; FW: 1876.35; yellow powder; m.p. dec.	50g 250g
93-0225	Ammonium sulfate, 99+% (ACS) (7783-20-2) (NH ₄) ₂ SO ₄ ; FW: 132.14; white xtl.; m.p. 235° dec.; d. 1.769	500g 2kg
93-0227 HAZ	Ammonium sulfide, 20% aqueous solution (12135-76-1) (NH ₄) ₂ S; FW: 68.14; yellow to dark orange liq.; d. 0.997 <i>STENCH</i>	100g 500g
02-0950 HAZ	Ammonium sulfide, 40-44% aqueous solution (12135-76-1) (NH ₄) ₂ S; FW: 68.14; yellow to dark orange liq. <i>STENCH</i>	100g 500g
93-0203	Ammonium tetraborate tetrahydrate, 99% (12228-87-4) (NH ₄) ₂ B ₄ O ₇ ·4H ₂ O; FW: 263.38; colorless xtl.	500g
02-1000	Ammonium tetrachloroaurate(III) hydrate (99.9985%-Au) PURATREM (13874-04-9) NH ₄ AuCl ₄ ·XH ₂ O; FW: 356.82; yellow xtl.	1g 5g
93-4602	Ammonium tetrachloropalladate(II), 99% (13820-40-1) (NH ₄) ₂ PdCl ₄ ; FW: 284.29; reddish-brown powder; m.p. dec.; d. 2.17	1g 5g
02-1275	Ammonium tetrachloropalladate(II) (99.998%-Pd) PURATREM (13820-40-1) (NH ₄) ₂ PdCl ₄ ; FW: 284.29; red to brown powder; m.p. dec.; d. 2.17	1g 5g

AMMONIUM (Compounds)

93-7802	Ammonium tetrachloroplatinate(II), 99% (13820-41-2) (NH ₄) ₂ PtCl ₆ ; FW: 372.98; red powdr.; m.p. 140-150° dec.; d. 2.936 <i>moisture sensitive</i>	1g 5g
93-0501 HAZ	Ammonium tetrafluoroborate, 99% (13826-83-0) NH ₄ BF ₄ ; FW: 104.84; white powdr.; m.p. subl.; d. 1.871	250g 1kg
42-1000	Ammonium tetrathiomolybdate(VI), 99% (99.99%-Mo) PURATREM (15060-55-6) (NH ₄) ₂ MoS ₄ ; FW: 260.27; red-green xtl. <i>air sensitive, (store cold)</i>	5g 25g
74-1000	Ammonium tetrathiotungstate(VI), 99% (99.9+%-W) (13862-78-7) (NH ₄) ₂ WS ₄ ; FW: 348.18; yellow to orange xtl.	5g 25g
93-0250	Ammonium tungstate pentahydrate (99.996%-W) PURATREM (1311-93-9) (NH ₄) ₁₀ W ₁₂ O ₄₁ ·5H ₂ O; FW: 3042.56 (3132.63); white xtl.	10g 50g
02-5043	3-(Decyldimethylammonio)propanesulfonate (Sulfobetaine 10) (15163-36-7) See page 167	
02-5055	N-Dodecyl-N,N-dimethyl-3-ammonio-1-propanesulfonate (Sulfobetaine 12) (14933-08-5) See page 167	
02-5045	Hexadecyltrimethylammonium bromide, 99+% CTAB (57-09-0) See page 168	
02-5056	N-Octyldodecyl-N,N-dimethyl-3-ammonio-1-propanesulfonate (Sulfobetaine 18) (13177-41-8) See page 168	
02-5000 HAZ	Tetrabutylammonium borohydride, 97% (33725-74-5) (C ₄ H ₉) ₄ NBH ₄ ; FW: 257.29; white powdr.; m.p. 124-128° <i>moisture sensitive</i>	10g 50g
02-5005	Tetrabutylammonium bromide, 99% (1643-19-2) (C ₄ H ₉) ₄ NBr; FW: 322.37; white xtl.; m.p. 103-104°	25g 100g 500g
02-5012 HAZ	Tetrabutylammonium fluoride, 1M in THF (429-41-4) (C ₄ H ₉) ₄ NF; FW: 261.46; colorless to pale-yellow liq.; f.p. 1°F (THF)	0.05mole 0.25mole
02-5015	Tetrabutylammonium fluoride hydrate, 98% TBAF (22206-57-1) (C ₄ H ₉) ₄ NF·XH ₂ O; FW: 261.47; white xtl. <i>hygroscopic</i>	5g 25g
09-6634 HAZ	Tetrabutylammonium hexafluorophosphate, 98% (3109-63-5) (C ₄ H ₉) ₄ NPF ₆ ; FW: 387.44; white xtl.; m.p. 244-246°	5g 25g
07-1967 HAZ	Tetrabutylammonium hydroxide, 40% in water (2052-49-5) (C ₄ H ₉) ₄ NOH; FW: 259.47; colorless liq.; d. 1.000	25g 100g
07-1969 HAZ	Tetrabutylammonium perchlorate, min. 98% (1923-70-2) (C ₄ H ₉) ₄ NClO ₄ ; FW: 341.92; white xtl. <i>hygroscopic</i>	25g 100g
44-7760 HAZ	Tetrabutylammonium perruthenate, min. 97% TBAP (96317-72-5) (C ₄ H ₉) ₄ N ⁺ RuO ₄ ⁻ ; FW: 407.41; green xtl.; m.p. 157° (dec.) <i>(store cold)</i>	500mg 2g
Technical Note:		
1. A mild oxidant for the selective transformation of primary alcohols to aldehydes and secondary alcohols to ketones.		
09-6635	Tetrabutylammonium tetrafluoroborate, 99% (429-42-5) (C ₄ H ₉) ₄ NBF ₄ ; FW: 329.28; white powdr.; m.p. 160-162°	5g 25g
75-1000	Tetrabutylammonium tetrathiorhenate(VII), 99% (16829-47-3) (C ₄ H ₉) ₄ NReS ₄ ; FW: 556.94; black xtl.	1g 5g
93-0573 HAZ	Tetraethylammonium borohydride (17083-85-1) (C ₂ H ₅) ₄ NBH ₄ ; FW: 145.10; white powdr.; m.p. 225° dec.; d. 0.926 <i>moisture sensitive</i>	2g 10g
93-0536 HAZ	Tetramethylammonium borohydride, 95% (16883-45-7) (CH ₃) ₄ NBH ₄ ; FW: 88.99; white xtl.; m.p. 150° dec.; d. 0.813 <i>moisture sensitive</i>	10g 50g
26-3765	Tetramethylammonium ferricyanide, 98% (14591-44-7) See page 111	

AMMONIUM (Compounds)

02-5065	Tetramethylammonium hydroxide pentahydrate, min. 95% (10424-65-4) See page 169	
09-6938	Tetramethylammonium tetrafluoroborate, 97% (661-36-9) (CH ₃) ₄ NBF ₄ ; FW: 160.95; white xtl.; m.p. >330° <i>hygroscopic</i>	10g 50g
02-5040	Tetraoctylammonium chloride, min. 97% (3125-07-3) See page 169	
44-7850 HAZ	Tetrapropylammonium perruthenate, min. 97% TPAP (114615-82-6) (C ₃ H ₇) ₄ N ⁺ RuO ₄ ⁻ ; FW: 351.43; green xtl.; m.p. 165° (dec.) (store cold)	500mg 2g

Technical Note:

1. A mild oxidant for the selective transformation of primary alcohols to aldehydes and secondary alcohols to ketones.

ANTIMONY (Elemental Forms)

51-0050	Antimony bar (99.999+%) (7440-36-0) Sb; FW: 121.76; (~434g/bar) 2.54 x 2.54 x 10.2cm; m.p. 630°; b.p. 1380°; d. 6.684	1pc
93-5142 HAZ	Antimony powder (99.5%) (7440-36-0) Sb; FW: 121.76; -100 mesh; m.p. 630°; b.p. 1380°; d. 6.684	250g 1kg
93-5134 HAZ	Antimony powder (99.5%) (7440-36-0) Sb; FW: 121.76; -325 mesh; m.p. 630°; b.p. 1380°; d. 6.684	100g 500g 2kg
93-5133 HAZ	Antimony powder (99.999%) (7440-36-0) Sb; FW: 121.76; -100 mesh; m.p. 630°; b.p. 1380°; d. 6.684	5g 25g
51-0085	Antimony rod (99.8%) (7440-36-0) Sb; FW: 121.76; 12.5mm dia. x 100mm long (~81g/100mm); m.p. 630°; b.p. 1380°; d. 6.684	1rod 5rods
51-0090	Antimony shot (99.999%) (7440-36-0) Sb; FW: 121.76; 5mm and down; m.p. 630°; b.p. 1380°; d. 6.684	10g 50g 250g
93-5145	Antimony shot (99.9999%) (7440-36-0) Sb; FW: 121.76; 1 mm dia.; m.p. 630°; b.p. 1380°; d. 6.684	5g 25g

ANTIMONY (Compounds)

93-5111 HAZ	Antimony(III) acetate, 97% (6923-52-0) Sb(OOCCH ₃) ₃ ; FW: 298.88; off-white powdr. <i>moisture sensitive</i>	50g 250g
93-5112 HAZ	Antimony(III) bromide, 99% (7789-61-9) SbBr ₃ ; FW: 361.48; off-white powdr.; m.p. 96.6°; b.p. 280°; d. 4.148 <i>moisture sensitive</i>	50g 250g
93-5113	Antimony(III) n-butoxide, 99% (2155-74-0) Sb(OC ₄ H ₉) ₃ ; FW: 341.10; colorless liq.; b.p. 133-135°/4 mm; d. 1.23 <i>moisture sensitive</i>	5g 25g
93-5131 HAZ	Antimony(III) chloride (99%-Sb) (10025-91-9) SbCl ₃ ; FW: 228.11; off-white xtl.; m.p. 73.4°; b.p. 283°; d. 3.140 <i>moisture sensitive</i>	250g 1kg
97-0373 amp HAZ	Antimony(III) chloride, elec. gr. (99.999%-Sb) PURATREM (10025-91-9) SbCl ₃ ; FW: 228.11; off-white xtl.; m.p. 73.4°; b.p. 283°; d. 3.140 <i>moisture sensitive</i>	5g 25g
93-5102 HAZ	Antimony(V) chloride, 99% (7647-18-9) SbCl ₅ ; FW: 299.02; colorless to yellow liq.; m.p. 2.8°; b.p. 79°/22 mm; d. 2.336 <i>moisture sensitive</i>	100g 500g
51-2200 amp HAZ	Antimony(V) chloride, (99.999%-Sb) PURATREM (7647-18-9) SbCl ₅ ; FW: 299.02; yellow liq.; m.p. 2.8°; b.p. 79°/22mm; d. 2.336 <i>moisture sensitive</i>	5g 25g
93-5115 HAZ	Antimony(III) ethoxide, 99% (10433-06-4) Sb(OC ₂ H ₅) ₃ ; FW: 256.90; colorless liq.; b.p. 95°/11 mm; f.p. 140°F; d. 1.524 <i>moisture sensitive</i>	5g 25g

ANTIMONY (Compounds)

93-5132 HAZ	Antimony(III) fluoride, 98% (7783-56-4) SbF ₃ ; FW: 178.75; off-white powdr.; m.p. 292°; b.p. 319° subl.; d. 4.379 <i>moisture sensitive</i>	50g 250g
93-5116 HAZ	Antimony(III) iodide (99.9%-Sb) (7790-44-5) SbI ₃ ; FW: 502.46; red powdr.; m.p. 170°; b.p. 401°; d. 4.917 <i>moisture sensitive</i>	5g 25g 100g
93-5119 HAZ	Antimony(III) oxide, 99+% (1309-64-4) Sb ₂ O ₃ ; FW: 291.50; white powdr.; m.p. 656°; b.p. 1550° subl.; d. 5.67	250g 1kg
97-0380 HAZ	Antimony(III) oxide, elec. gr. (99.999%-Sb) PURATREM (1309-64-4) Sb ₂ O ₃ ; FW: 291.50; white powdr.; m.p. 656°; b.p. 1550° subl.; d. 5.67	25g 100g
51-5110 HAZ	Antimony(IV) oxide (99.99%-Sb) PURATREM (1332-81-6) Sb ₂ O ₄ ; FW: 307.50; white to off-white powdr.; d. 5.82	5g 25g
93-5106 HAZ	Antimony(V) oxide (99.9%-Sb) (1314-60-9) Sb ₂ O ₅ ; FW: 323.5; -325 mesh white to light yellow powdr. (avg. 10 microns); d. 3.80	10g 50g
97-0382 HAZ	Antimony(V) oxide, elec. gr. (99.998%-Sb) PURATREM (1314-60-9) Sb ₂ O ₅ ; FW: 323.50; white to light yellow powdr.; d. 3.80	5g 25g 100g
93-5120 HAZ	Antimony(III) sulfide (99.999%-Sb) PURATREM (1345-04-6) Sb ₂ S ₃ ; FW: 339.68; black powdr.; m.p. 550°; b.p. ~1150°; d. 4.12	10g 50g
51-2400 HAZ	Antimony(V) sulfide, min. 98% (1315-04-4) Sb ₂ S ₅ ; FW: 403.82; yellow-orange solid	50g 250g
51-1430	Antimony(III) telluride (99.96%-Sb) (1327-50-0) Sb ₂ Te ₃ ; FW: 626.32; black powdr.	1g 5g
93-5130 HAZ	Hydrogen hexafluoroantimonate(V), 65-70% aqueous solution (16950-06-4) HSbF ₆ ; FW: 236.75; yellow to colorless liq.	25g 100g
03-1200	Lithium hexafluoroantimonate, min. 97% (18424-17-4) See page 117	
93-0738	Nitronium hexafluoroantimonate, min. 97% (17856-92-7) See page 204	
51-3000 HAZ	Triphenylantimony, 97% (603-36-1) (C ₆ H ₅) ₃ Sb; FW: 353.07; off-white xtl.; m.p. 54°; b.p. > 360°; d. 1.4343	10g 50g
93-5125	Triphenylantimony dibromide, 98+% (1538-59-6) (C ₆ H ₅) ₃ SbBr ₂ ; FW: 512.89; white xtl. <i>moisture sensitive</i>	1g 5g
93-5124 HAZ	Triphenylantimony dichloride, 99% (594-31-0) (C ₆ H ₅) ₃ SbCl ₂ ; FW: 423.98; white xtl.; m.p. 143-145° <i>moisture sensitive</i>	2g 10g
51-5000 HAZ	Tris(dimethylamino)antimony (99.99%-Sb) PURATREM (7289-92-1) (CH ₃) ₂ N) ₃ Sb; FW: 253.99; colorless liq.; b.p. 32-34°/0.45mm; d. 1.325 <i>air sensitive, moisture sensitive</i>	1g 5g 25g

ARSENIC (Elemental Forms)

93-3332 HAZ	Arsenic powder (99%) (7440-38-2) As; FW: 74.92; -20 mesh gray powdr.	25g 100g
93-3330 HAZ	Arsenic sponge (99.99%) (7440-38-2) As; FW: 74.92; irregular pieces, 30mm and down; m.p. 814°; b.p. 615°; d. 5.724	25g 100g

ARSENIC (Compounds)

93-3308 HAZ	Arsenic(III) bromide (99.9%-As) (7784-33-0) AsBr ₃ ; FW: 314.65; colorless to yellow lumps; m.p. 32.8°; b.p. 221°; d. 3.54 <i>moisture sensitive</i>	50g
93-3310 HAZ	Arsenic(III) chloride, 99% (7784-34-1) AsCl ₃ ; FW: 181.27; colorless liq.; m.p. -8.5°; b.p. 130.2°; d. 2.163 <i>moisture sensitive</i>	25g 100g



ARSENIC (Compounds)

93-3309 amp HAZ 	Arsenic(III) chloride (99.999%-As) PURATREM (7784-34-1) AsCl ₃ ; FW: 181.27; colorless liq.; m.p. -8.5°; b.p. 130.2°; d. 2.163 <i>moisture sensitive</i>	5g 25g 100g
93-3312 HAZ	Arsenic(III) iodide, 98% (7784-45-4) AsI ₃ ; FW: 455.62; red powdr.; m.p. 146°; b.p. 403°; d. 4.39 <i>moisture sensitive</i>	25g 100g
93-3313 HAZ	Arsenic(III) oxide, tech. gr. (1327-53-3) As ₂ O ₃ ; FW: 197.84; white powdr.; m.p. 315°; b.p. 465° subl.; d. 3.738	50g 250g
33-3313 HAZ	Arsenic(III) oxide, primary standard, 99.95+% (ACS) (1327-53-3) As ₂ O ₃ ; FW: 197.84; white powdr.; m.p. 315°; b.p. 465° subl.; d. 3.738	100g
97-0425 HAZ	Arsenic(III) oxide, elec. gr. (99.999%-As) PURATREM (1327-53-3) As ₂ O ₃ ; FW: 197.84; white powdr.; m.p. 315°; b.p. 465° subl.; d. 3.738	5g 25g 100g
93-3304 HAZ	Arsenic(V) oxide (99.9+%-As) (1303-28-2) As ₂ O ₅ ; FW: 229.79; white powdr.; m.p. 315° dec.; d. 4.32 <i>moisture sensitive</i>	10g 50g
93-3305 HAZ	Arsenic(III) selenide (99.999%-As) PURATREM (1303-36-2) As ₂ Se ₃ ; FW: 386.72; black xtl.; m.p. ~360°; d. 4.75	5g 25g
93-3316 HAZ	Arsenic(III) sulfide (99.9%-As) (1303-33-9) As ₂ S ₃ ; FW: 246.03; orange powdr. to coarse solid; m.p. 300°; b.p. 707°; d. 3.43 <i>moisture sensitive</i>	10g 50g
33-1199 HAZ	Arsenic(III) sulfide, fused lumps (99.999%-As) PURATREM (1303-33-9) As ₂ S ₃ ; FW: 246.03; fused lumps; m.p. 300°; b.p. 707°; d. 3.43 <i>moisture sensitive</i>	10g 50g
93-3318 HAZ	Dimethylarsinic acid (Cacodylic acid), 98% (75-60-5) (CH ₃) ₂ AsOOH; FW: 138.00; white powdr.; m.p. 200°	10g 50g
93-3322 HAZ	Phenylarsonic acid, 98% (98-05-5) C ₆ H ₅ AsO(OH) ₂ ; FW: 202.03; white powdr.; m.p. 163° dec.; d. 1.760	5g 25g
33-3050 HAZ	Tetraphenylarsonium chloride monohydrate, 99% (507-28-8) (C ₆ H ₅) ₄ AsCl·H ₂ O; FW: 418.80 (436.81); white powdr.; m.p. 257°	1g 5g 25g
33-3400 amp HAZ	Triethylarsine, 99% (617-75-4) (C ₂ H ₅) ₃ As; FW: 162.09; colorless to pale yellow liq.; m.p. -91°; b.p. 140°; d. 1.152 <i>air sensitive</i>	5g 25g
33-3750 amp HAZ	Trimethylarsine, 99% (593-88-4) (CH ₃) ₃ As; FW: 120.03; colorless liq.; m.p. -87.3°; b.p. 51°; f.p. 100°F; d. 1.124 <i>air sensitive</i>	5g 25g
98-1975 amp HAZ	Trimethylarsine, elec. gr. (99.995%-As) PURATREM (593-88-4) (CH ₃) ₃ As; FW: 120.03; colorless liq.; m.p. -87.3°; b.p. 51°; f.p. 100°F; d. 1.124 <i>air sensitive</i>	25g
33-4000 HAZ	Triphenylarsine, min. 97% (603-32-7) (C ₆ H ₅) ₃ As; FW: 306.24; white powdr.; m.p. 59-60°; b.p. 233°/14 mm; d. 1.2225 For detailed technical note visit strem.com .	5g 25g
33-5000 HAZ	Tris(dimethylamino)arsine, 99% (6596-96-9) ((CH ₃) ₂ N) ₃ As; FW: 207.15; colorless liq.; b.p. 55°/10mm <i>air sensitive, moisture sensitive</i>	5g 25g

BARIUM (Elemental Forms)

56-0075 HAZ	Barium pieces (99.7%, Sr<1.0%) (7440-39-3) Ba; FW: 137.34; 19mm and down (packed in mineral oil); m.p. 725°; b.p. 1640°; d. 3.51 <i>air sensitive, moisture sensitive</i>	10g 50g 250g
56-0074 amp HAZ	Barium pieces, dendritic (99.9%) (7440-39-3) Ba; FW: 137.34; ampouled under argon; m.p. 725°; b.p. 1640°; d. 3.51 <i>air sensitive, moisture sensitive</i>	5g 25g

BARIUM (Elemental Forms)

56-0080	Barium rod (99+% Sr < 1.6%) (7440-39-3)	100g
HAZ	Ba; FW: 137.34; 22mm dia. (~100g/6.9cm) (packed under oil); m.p. 725°; b.p. 1640°; d. 3.51 <i>air sensitive, moisture sensitive</i>	500g

BARIUM (Compounds)

93-5601	Barium acetate, 99% (ACS) (543-80-6)	100g
HAZ	Ba(OOCCH ₃) ₂ ; FW: 255.43; white powdr.; d. 2.468	500g
93-5657	Barium acetylacetonate hydrate (12084-29-6)	10g
HAZ	Ba(CH ₃ COCHCOCH ₃) ₂ ·XH ₂ O; FW: 335.53; white to off-white powdr.; m.p. > 320°	50g 250g
56-5656	Barium bis(N,N,N',N',N''-pentamethyldiethylenetriamine)bis[BREW] (99.99+%-Ba) PURATREM	1g
	Ba(C ₉ H ₂₃ N ₅) ₂ [C·HyC(O)CHC(O)C·Hy] ₂ (x=3-4, y=2x+1); pale yellow liq. <i>moisture sensitive</i>	5g 25g
	Note: 13-16 wt% Ba; ***Limited quantities available. Will discontinue when stock gone***	
Technical Note:		
1. H-BREW is a mixture of propyl and butyl substituted beta-diketonates capable of forming a wide variety of metal complexes suitable for MOCVD. In most cases, the metal complexes are liquids, are completely miscible with polar and non-polar organic solvents and are miscible with other metal complexes in essentially all proportions.		
93-5606	Barium bromide, anhydrous, min. 95% (10553-31-8)	25g
HAZ	BaBr ₂ ; FW: 297.16; white powdr.; m.p. 850°; d. 4.781	100g
56-1020	Barium carbonate (99.9%-Ba, Sr < .03%) (513-77-9)	100g
HAZ	BaCO ₃ ; FW: 197.35; -325 mesh powdr.; d. 4.43	500g
56-1025	Barium carbonate (99.999%-Ba) PURATREM (513-77-9)	10g
HAZ	BaCO ₃ ; FW: 197.35; white powdr.; d. 4.43	50g
93-5652	Barium chloride, anhydrous, 98+% (10361-37-2)	100g
HAZ	BaCl ₂ ; FW: 208.24; white powdr.; m.p. 963°; b.p. 1560°; d. 3.856	500g
93-5610	Barium chloride dihydrate, 99% (ACS) (10326-27-9)	250g
HAZ	BaCl ₂ ·2H ₂ O; FW: 208.24 (244.27); white xtl.; d. 3.097	1kg
56-1030	Barium chloride dihydrate (99.999%-Ba) PURATREM (10326-27-9)	10g
HAZ	BaCl ₂ ·2H ₂ O; FW: 208.24 (244.28); white xtl.; d. 3.097	50g
93-5626	Barium 2-ethylhexanoate, ~30% in xylene (7-10% Ba) (2457-01-4)	25g
HAZ	Ba[OOCCH(C ₂ H ₅)C ₄ H ₉] ₂ ; FW: 423.76; viscous liq.; f.p. 85°F (xylenes)	100g
56-4000	Barium 2-ethylhexoxide (~1M in hexanes/toluene) (29170-99-8)	5g
HAZ	Ba[OCH ₂ (C ₂ H ₅)CH(CH ₂) ₃ CH ₃] ₂ ; FW: 395.77; orange liq.; f.p. -9°F <i>moisture sensitive</i>	25g 100g
93-5614	Barium fluoride, 99% (7787-32-8)	250g
HAZ	BaF ₂ ; FW: 175.34; white powdr.; m.p. 1280°; b.p. 2137°; d. 4.89	1kg
93-5613	Barium fluoride (99.99+%-Ba) PURATREM (7787-32-8)	10g
HAZ	BaF ₂ ; FW: 175.34; white powdr.; m.p. 1280°; b.p. 2137°; d. 4.89	50g
56-5000	Barium hexafluoroacetylacetonate (118131-57-0)	1g
HAZ	Ba(CF ₃ COCHCOCF ₃) ₂ ; FW: 551.44; white powdr.; m.p. 220° dec.	5g 25g
93-5654	Barium hydride (99.5%-Ba) (13477-09-3)	2g
HAZ	BaH ₂ ; FW: 139.35; -60 mesh gray xtl.; m.p. 675° dec.; d. 4.21 <i>moisture sensitive</i>	10g
93-5616	Barium hydroxide, anhydrous, min. 95% (17194-00-2)	100g
HAZ	Ba(OH) ₂ ; FW: 171.34; white powdr. <i>hygroscopic</i>	500g
93-5617	Barium hydroxide octahydrate, 98+% (ACS) (12230-71-6)	250g
HAZ	Ba(OH) ₂ ·8H ₂ O; FW: 171.34 (315.46); white xtl.; m.p. 78°; d. 2.18	1kg
93-5619	Barium iodide, anhydrous, min. 97% (13718-50-8)	25g
HAZ	BaI ₂ ; FW: 391.15; off-white powdr. <i>hygroscopic</i>	100g
56-7075	Barium manganate, 90% (7787-35-1)	10g
HAZ	BaMnO ₄ ; FW: 256.28; greenish-gray xtl.; d. 4.850 <i>moisture sensitive</i>	50g

BARIUM (Compounds)

56-7000 HAZ	Barium neodecanoate, superconductor grade (25-29% Ba) (55172-98-0) Ba(OOC ₁₀ H ₁₉) ₂ ; FW: 479.83; off-white solid	10g 50g
93-5625 HAZ	Barium nitrate, 99.5% (10022-31-8) Ba(NO ₃) ₂ ; FW: 261.35; white xtl.; m.p. 592°; d. 3.230 <i>hygroscopic</i>	100g 500g
93-5624 HAZ	Barium nitrate (99.95%-Ba) (10022-31-8) Ba(NO ₃) ₂ ; FW: 261.35; white xtl.; m.p. 592°; d. 3.230 <i>hygroscopic</i>	10g 50g
56-7500 HAZ	Barium nitrate (99.999%-Ba) PURATREM (10022-31-8) Ba(NO ₃) ₂ ; FW: 261.35; white xtl.; m.p. 592°; d. 3.230 <i>hygroscopic</i>	10g 50g
56-7510	Barium nitride (99.7%-Ba) (12047-79-9) Ba ₃ N ₂ ; FW: 439.99; -20 mesh black powdr.	1g 5g
93-5651 HAZ	Barium oxide (99.5%-Ba) (1304-28-5) BaO; FW: 153.33; -100 mesh off-white to light-gray powdr.; m.p. 1923°; d. 5.72 <i>moisture sensitive</i>	25g 100g
93-5650 HAZ	Barium perchlorate trihydrate (99.9%-Ba) (10294-39-0) Ba(ClO ₄) ₂ ·3H ₂ O; FW: 336.24 (390.29); white xtl.; m.p. 400° dec.; d. 2.74 <i>hygroscopic</i>	100g 500g
93-5630 HAZ	Barium peroxide, min. 84% (99%-Ba) (1304-29-6) BaO ₂ ; FW: 169.34; white to off-white powdr.; m.p. 450°; d. 4.96 <i>moisture sensitive</i>	250g 1kg
56-8000 HAZ	Barium i-propoxide, dry powder (24363-37-9) Ba(OC ₃ H ₇) ₂ ; FW: 255.52; off-white powdr. <i>moisture sensitive</i>	5g 25g
56-8001 HAZ	Barium i-propoxide (~20% in isopropanol) (24363-37-9) Ba(OC ₃ H ₇) ₂ ; FW: 255.52; yellow to brown liq.; f.p. 72°F (isopropanol) <i>moisture sensitive</i>	5g 25g
93-5644 HAZ	Barium stearate, tech. gr. (6865-35-6) Ba(O ₂ C ₁₈ H ₃₅) ₂ ; FW: 704.30; white powdr.	250g 1kg
93-5636 HAZ	Barium sulfide, 75% (21109-95-5) BaS; FW: 169.40; black powdr.; m.p. 1200°; d. 4.25 <i>air sensitive, moisture sensitive</i>	500g 2kg
78-0083 HAZ	Barium tetracyanoplatinate(II) tetrahydrate, 99% (13755-32-3) BaPt(CN) ₄ ·4H ₂ O; FW: 436.50 (508.57); yellow powdr.; d. 2.076	1g 5g
93-5640	Barium titanate, 99% (12047-27-7) BaTiO ₃ ; FW: 233.21; white powdr.; m.p. 1620°; d. 5.85	250g 1kg
93-5639	Barium titanate, sintered lump (99.9%-Ba) (12047-27-7) BaTiO ₃ ; FW: 233.21; 3-12mm white pieces; m.p. 1620°; d. 5.85	25g 100g
56-8100 HAZ	Barium trifluoromethanesulfonate, 99% (Barium triflate) (2794-60-7) Ba(CF ₃ SO ₃) ₂ ; FW: 435.47; white powdr.; m.p. dec. <i>hygroscopic</i>	5g 25g
56-8120 HAZ	Barium trifluoromethanesulfonimide, min. 97% (168106-22-7) Ba(C ₂ F ₆ NO ₄ S ₂) ₂ ; FW: 697.62; white to off-white powdr. <i>hygroscopic</i>	250mg 1g 5g
56-8400 HAZ	Bis(6,6,7,7,8,8,8-heptafluoro-2,2-dimethyl-3,5-octanedionate)barium [Ba-(FOD)₂] (36885-31-1) Ba(C ₁₀ H ₁₀ F ₇ O ₂) ₂ ; FW: 727.71; white to off-white powdr.; m.p. 194-198°; b.p. dec. 280-300° (subl. 210°/0.2mm)	1g 5g 25g
56-8450 NEW amp HAZ	Bis(pentamethylcyclopentadienyl)barium, 98% (112379-49-4) C ₂₀ H ₃₀ Ba; FW: 407.78; white solid <i>air sensitive, moisture sensitive</i> For detailed technical note visit strem.com .	500mg 2g
56-8460 HAZ	Bis(n-propyltetramethylcyclopentadienyl)barium, min. 98% (210758-43-3) Ba[(C ₂ H ₅)(CH ₃) ₄ C ₅] ₂ ; FW: 463.90; viscous yellow liq. <i>air sensitive, moisture sensitive</i>	250mg 1g 5g

BARIUM (Compounds)

56-8500 HAZ	Bis(2,2,6,6-tetramethyl-3,5-heptanedionato)barium hydrate [Ba(TMHD)₂] (17594-47-7) Ba(C ₁₁ H ₁₉ O ₂) ₂ ·XH ₂ O; FW: 503.85; white powdr.; m.p. 195-200°; b.p. dec. 285° (subl. 225°/0.05mm) <i>moisture sensitive</i>	1g 5g 25g
56-8600 HAZ	Bis(2,2,6,6-tetramethyl-3,5-heptanedionato)barium tetraglyme adduct (99.99%-Ba, Sr-0.5%) PURATREM (136629-60-2) Ba(C ₁₁ H ₁₉ O ₂) ₂ ·CH ₃ (OCH ₂ CH ₂) ₄ OCH ₃ ; FW: 503.85 (726.13); white xtl.; m.p. 103°	1g 5g
56-8610 HAZ	Bis(2,2,6,6-tetramethyl-3,5-heptanedionato)barium triglyme adduct(99.99%-Ba, Sr-0.5%) PURATREM (149160-45-2) Ba(C ₁₁ H ₁₉ O ₂) ₂ ·CH ₃ (OCH ₂ CH ₂) ₃ OCH ₃ ; FW: 503.85 (682.09); off-white powdr.; m.p. 88°	1g 5g

BERYLLIUM (Elemental Forms)

04-0080 HAZ	Beryllium foil (99.5%) (7440-41-7) Be; FW: 9.012; 0.1mm thick (-0.12g/25 x25mm); m.p. 1278°; b.p. 2970° (5mm); d. 1.85	25 x 25mm 50 x 50mm
93-0420 HAZ	Beryllium powder (99+%) (7440-41-7) Be; FW: 9.01; -325 mesh; m.p. 1278°; b.p. 2970° (5mm); d. 1.85 Note: For sale in USA. For other countries contact Strem.	5g 25g

BERYLLIUM (Compounds)

04-4025 HAZ	Beryllium oxide (99.95+% -Be) (1304-56-9) BeO; FW: 25.01; white powdr.; m.p. 2575°; b.p. 4300°; d. 3.010	5g 25g
----------------	--	-----------

BIOCATALYSTS (Compounds)

06-3110 NEW	Alcalase® 2.4 L FG (9014-01-1) brown liq.; d. 1.17 (store cold) Note: Store at 0-10°C. DO NOT FREEZE. Declared activity 2.4 AU-A/g. Serine endoprotease that hydrolyzes internal peptide bonds. Color can vary from batch to batch. Color intensity is not an indication of enzyme activity. Packaging must be kept intact, dry and away from sunlight. Please follow the recommendations and use the product before the best before date to avoid the need for a higher dosage. Sold in collaboration with Novozymes A/S. Novozymes does not promote nor support the use of enzymes as Active Pharmaceutical Ingredients or excipients. www.strem.com/novozymes	10g 50g 250g
06-3112 NEW	Alcalase® 2.5 L (9014-01-1) amber liq. (semitransparent); d. 1.08 (store cold) Note: Store at 0-10°C. DO NOT FREEZE. Declared activity 2.5 AU-A/g. Serine endoprotease that hydrolyzes internal peptide bonds. Color can vary from batch to batch. Color intensity is not an indication of enzyme activity. Packaging must be kept intact, dry and away from sunlight. Please follow the recommendations and use the product before the best before date to avoid the need for a higher dosage. Sold in collaboration with Novozymes A/S. Novozymes does not promote nor support the use of enzymes as Active Pharmaceutical Ingredients or excipients. www.strem.com/novozymes	10g 50g 250g
07-3155 NEW	CalB immo 1090™ - Immobilized enzyme white to slightly yellow spherical beads, dry (store cold) Note: Store in dry conditions (2-8°C). Do not freeze. Shelf Life: 1 year; Particle Size: 300-710 micron; CalB immo 1090 is an adsorbed preparation and is suitable for applications in solvent-free systems like oils, as well as organic solvents and it can be used for (regio- and stereoselective) esterifications and transesterifications. CalB Immo 1090 has many advantages including high activity and the possibility to use in oils, organic solvent and bi-phasic systems. Sold in collaboration with Puro-lite for research purposes only.	10g 50g 250g

BIOCATALYSTS (Compounds)

07-3152	CalB immo 5587™ - Immobilized enzyme	10g 50g 250g
NEW	white to slightly yellow spherical beads, dry (store cold) Note: Store in dry conditions (2-8°C). Do not freeze. Shelf Life: 1 year; Particle Size: 300-710 micron; CalB immo 5587 is an adsorbed preparation and is particularly suitable for applications where cost is an essential parameter, like biodiesel or industrial oil manufacture. CalB Immo 5587 has many advantages including cost-effectiveness in processes like biodiesel manufacture. It is also a highly robust carrier, particularly suitable for column configurations. Sold in collaboration with Purolite for research purposes only.	
07-3159	CalB immo 5872™ - Immobilized enzyme	10g 50g 250g
NEW	white to slightly yellow spherical beads, dry (store cold) Note: Store in dry conditions (2-8°C). Do not freeze. Shelf Life: 1 year; Particle Size: 300-1500 micron; CalB immo 5872 is an adsorbed preparation and is suitable for applications in solvent-free systems like oils, as well as organic solvents and it can be used for (regio- and stereoselective) esterifications and transesterifications. CalB Immo 5872 has many advantages including cost-effectiveness and the possibility to use in oils, organic solvent and bi-phasic systems. Sold in collaboration with Purolite for research purposes only.	
07-3142	CalB immo 8285™ - Immobilized enzyme	10g 50g 250g
NEW	white to slightly yellow spherical beads, dry (store cold) Note: Store in dry conditions (2-8°C). Do not freeze. Shelf Life: 1 year; Particle Size: 100-710 micron; CalB immo 8285 is covalently immobilized and is suitable for applications in water, organic solvents as well as solvent-free systems and can be used for (regio- and stereoselective) hydrolysis, esterifications and transesterifications. The lipase is immobilized by covalent immobilization onto PuroLites highly hydrophobic carrier PuroLite ECR8285 (an epoxy/butyl methacrylate co-polymer). Sold in collaboration with PuroLite for research purposes only.	
07-3148	CalB immo 8806™ - Immobilized enzyme	10g 50g 250g
NEW	white to slightly yellow spherical beads, dry (store cold) Note: Store in dry conditions (2-8°C). Do not freeze. Shelf Life: 1 year; Particle Size: 300-710 micron; CalB immo 8806 is an adsorbed preparation and is suitable for applications in solvent-free systems like oils, as well as organic solvents and it can be used for (regio- and stereoselective) esterifications and transesterifications. CalB Immo 8806 has many advantages including high activity and the possibility to use in oils, organic solvent and bi-phasic systems. Sold in collaboration with PuroLite for research purposes only.	
96-4050	CalB immo KIT™ - Immobilized enzyme	
	See page 462	
07-3130	CalB immo Plus™ - Immobilized enzyme	10g 50g 250g
NEW	white to off white spherical beads, dry (store cold) Note: Store in dry conditions (2-8°C). Do not freeze. Shelf Life: 1 year; Particle Size: 300-710 micron; CalB immo Plus is suitable for applications in organic solvents as well as solvent-free systems and can be used for (regio- and stereoselective) esterifications and transesterifications. CalB Immo Plus has many advantages including high activity and high mechanical stability. Sold in collaboration with PuroLite for research purposes only.	
07-3133	CalB immo Plus Food Grade™ - Immobilized enzyme	10g 50g 250g
NEW	white to slightly yellow spherical beads, dry (store cold) Note: Store in dry conditions (2-8°C). Do not freeze. Shelf Life: 1 year; Particle Size: 300-710 micron; CalB immo Plus Food Grade is supplied in food-grade quality and conforms to the General Specifications and Considerations for Enzyme Preparations Used in Food Processing of the Joint FAO/WHO Expert Committee on Food Additives (JECFA). CalB immo Plus is suitable for applications in organic solvents as well as a solvent-free systems and can be used for (regio- and stereoselective) esterifications and transesterifications. CalB Immo Plus has many advantages including high activity and high mechanical stability. Sold in collaboration with PuroLite for research purposes only.	

BIOCATALYSTS (Compounds)

06-0925 NEW	Enzyme carrier Lifetech™ ECR1030M White to off white spherical beads (wet); SA: 80 - 120 m ² /g (store cold) Note: Store in dry conditions (2-20°C). Do not freeze. Shelf Life: 5 years; Particle Size: 300-710 micron; Pore Diameter: 220-340; Lifetech ECR1030M is a copolymer of divinylbenzene (DVB) and methacrylate with no functional groups. It is used for enzyme immobilization by adsorption (hydrophobic interaction) and it is particularly suitable for lipase immobilization such as CALB. Lifetech ECR1030M main features are high mechanical stability compared to other existing resins, low surface area that grants high enzyme activity at low protein loading. Sold in collaboration with Purolite for research purposes only.	50g 5x50g
07-2215 NEW	Enzyme carrier Lifetech™ ECR1504 White to off white spherical beads (wet) (store cold) Note: Store in dry conditions (2-20°C). Do not freeze. Shelf Life: 5 years; Particle Size: 300-1200 micron; Lifetech ECR1504 is a copolymer of divinylbenzene (DVB) and styrene functionalised with tertiary amines. It is used for enzyme immobilization by ionic interaction of the ionizable surface aminoacids (Lys, Arg, His, Asp, Glu) with the tertiary amines on the polymer. It is particularly suitable for immobilization of enzymes with iP in the range 3 - 5 like many glycosidases. Lifetech ECR1504 main features are possibility to regenerate the resin, pH adjustment before immobilization and large particle size for column applications. Sold in collaboration with Purolite for research purposes only.	50g 5x50g
07-2220 NEW	Enzyme carrier Lifetech™ ECR1508 White to off white spherical beads (wet) (store cold) Note: Store in dry conditions (2-20°C). Do not freeze. Shelf Life: 5 years; Particle Size: 300-1200 micron; Lifetech ECR1508 is copolymer of divinylbenzene (DVB) and styrene functionalised with tertiary amines. It is used for enzyme immobilization by ionic interaction of the ionizable surface aminoacids (Lys, Arg, His, Asp, Glu) with the tertiary amines on the polymer. It is particularly suitable for immobilization of enzymes with iP in the range 3 - 5 like many glycosidases. Lifetech ECR1508 main features are possibility to regenerate the resin, pH adjustment before immobilization and large particle size for column applications. Sold in collaboration with Purolite for research purposes only.	50g 5x50g
07-2224 NEW	Enzyme carrier Lifetech™ ECR1604 White to off white spherical beads (wet) (store cold) Note: Store in dry conditions (2-20°C). Do not freeze. Shelf Life: 5 years; Particle Size: 300-1200 micron; Lifetech ECR1604 is a copolymer of divinylbenzene (DVB) and styrene functionalised with quaternary amines. It is used for enzyme immobilization by ionic interaction of the ionizable surface aminoacids (Lys, Arg, His, Asp, Glu) with the tertiary amines on the polymer. It is particularly suitable for immobilization of enzymes with iP in the range 3 - 5 like many glycosidases. Lifetech ECR1604 main features are possibility to regenerate the resin, pH adjustment before immobilization and large particle size for column applications. Sold in collaboration with Purolite for research purposes only.	50g 5x50g
07-2230 NEW	Enzyme carrier Lifetech™ ECR1640 White to off white spherical beads (wet) (store cold) Note: Store in dry conditions (2-20°C). Do not freeze. Shelf Life: 5 years; Particle Size: 300-1200 micron; Lifetech ECR1640 is a copolymer of divinylbenzene (DVB) and styrene functionalised with quaternary amines. It is used for enzyme immobilization by ionic interaction of the ionizable surface aminoacids (Lys, Arg, His, Asp, Glu) with the tertiary amines on the polymer. It is particularly suitable for immobilization of enzymes with iP in the range 3 - 5 like many glycosidases. Lifetech ECR1640 main features are possibility to regenerate the resin, pH adjustment before immobilization and large particle size for column applications. Sold in collaboration with Purolite for research purposes only.	50g 5x50g

BIOCATALYSTS (Compounds)

06-0928 NEW	Enzyme carrier Lifetech™ ECR1061M White to off white spherical beads (wet); SA: 400 - 510 m ² /g (store cold) Note: Store in dry conditions (2-20°C). Do not freeze. Shelf Life: 5 years; Particle Size: 300-710 micron; Pore Diameter: 600-750; Lifetech ECR1030M is a copolymer of divinylbenzene (DVB) and methacrylate with no functional groups. It is used for enzyme immobilization by adsorption (hydrophobic interaction) and it is particularly suitable for lipase immobilization such as CALB. Lifetech ECR1030M main features are high mechanical stability compared to other existing resins, low surface area that grants high enzyme activity at low protein loading. Sold in collaboration with Purolite for research purposes only.	50g 5x50g
06-0905 NEW	Enzyme carrier Lifetech™ ECR1090F White to off white spherical beads (wet); SA: 750 - 850 m ² /g (store cold) Note: Store in dry conditions (2-20°C). Do not freeze. Shelf Life: 5 years; Particle Size: 150-300 micron; Pore Diameter: 900-1100; Lifetech ECR1090F is a copolymer of divinylbenzene (DVB) and styrene with high porosity and no functional groups. It is used for enzyme immobilization by adsorption (hydrophobic interaction) and it is particularly suitable for lipase immobilization. Lifetech ECR1090F main features are high porosity, high mechanical stability and high surface area. Sold in collaboration with Purolite for research purposes only.	50g 5x50g
06-0913 NEW	Enzyme carrier Lifetech™ ECR1090M White to off white spherical beads (wet); SA: 750 - 850 m ² /g Note: Store in dry conditions (2-20°C). Do not freeze. Shelf Life: 5 years; Particle Size: 300-710 micron; Pore Diameter: 900-1100; Lifetech ECR1090M is a copolymer of divinylbenzene (DVB) and styrene with high porosity and no functional groups. It is used for enzyme immobilization by adsorption (hydrophobic interaction) and it is particularly suitable for lipase immobilization. Lifetech ECR1090M main features are high porosity, high mechanical stability and high surface area. Sold in collaboration with Purolite for research purposes only.	50g 5x50g
06-0922 NEW	Enzyme carrier Lifetech™ ECR1091M White to off white spherical beads (wet); SA: > 450 m ² /g (store cold) Note: Store in dry conditions (2-20°C). Do not freeze. Shelf Life: 5 years; Particle Size: 300-710 micron; Pore Diameter: 950-1200; Lifetech ECR1091M is a copolymer of divinylbenzene (DVB) and styrene with very high porosity and no functional groups. It is used for enzyme immobilization by adsorption (hydrophobic interaction) and it is particularly suitable for lipase immobilization. Lifetech ECR1091M main features are high porosity, high mechanical stability and high surface area. Sold in collaboration with Purolite for research purposes only.	50g 5x50g
06-0810 NEW	Enzyme carrier Lifetech™ ECR8204F White to off white spherical beads (wet) (store cold) Note: Store in dry conditions (2-8°C). Do not freeze. Shelf life: 6 months; Particle Size: 150-300 micron; Pore Diameter: 300-600; Lifetech ECR1640 is a copolymer of divinylbenzene (DVB) and styrene functionalised with quaternary amines. It is used for enzyme immobilization by ionic interaction of the ionizable surface aminoacids (Lys, Arg, His, Asp, Glu) with the tertiary amines on the polymer. It is particularly suitable for immobilization of enzymes with iP in the range 3 - 5 like many glycosidases. Lifetech ECR1640 main features are possibility to regenerate the resin, pH adjustment before immobilization and large particle size for column applications. Sold in collaboration with Purolite for research purposes only.	50g 5x50g
06-0813 NEW	Enzyme carrier Lifetech™ ECR8204M White to off white spherical beads (wet) (store cold) Note: Store in dry conditions (2-8°C). Do not freeze. Shelf Life: 6 months; Particle size: 300-710 micron; Pore Diameter: 300-600; Lifetech ECR8204M is a methacrylate polymer functionalised with epoxy groups, used for covalent enzyme immobilization. Epoxides form very stable covalent linkages with different protein surface groups as ε-NH ₂ in Lys or nucleophiles (amino, thiol, phenolic). Immobilization is performed under very mild experimental conditions of pH and temperature, at high ionic buffer strength. Lifetech ECR8204M main features are the low porosity, the hydrophilicity, high mechanical strength and it is optimal for use in batch reactors and columns.	50g 5x50g

BIOCATALYSTS (Compounds)

06-0817 NEW	Enzyme carrier Lifetech™ ECR8209F white to off white spherical beads (wet) <i>(store cold)</i> Note: Store in dry conditions (2-8°C). Do not freeze. Shelf Life: 6 months; Particle Size: 150-300 micron; Pore Diameter: 300-600; Lifetech ECR8209F is a methacrylate polymer functionalised with epoxy groups, used for covalent enzyme immobilization. Epoxy groups form very stable covalent linkages with different protein surface groups as ε-NH ₂ in Lys or nucleophiles (amino, thiol, phenolic). Immobilization is performed under very mild experimental conditions of pH and temperature, at high ionic buffer strength. Lifetech ECR8209F main features are the high porosity, the hydrophilicity and it is optimal for use in batch reactors.	50g 5x50g
07-1512 NEW	Enzyme carrier Lifetech™ ECR8309F white to off white spherical beads (wet); SA: 70 min. m ² /g <i>(store cold)</i> Note: Store in dry conditions (2-20°C). Do not freeze. Shelf Life: 5 years; Particle Size: 150-300 micron; Pore Diameter: 600-1200; Lifetech ECR8309F is a methacrylate polymer functionalised with amino groups on a short spacer (C2). It is used for covalent enzyme immobilization by pre-activation of the resin with glutaraldehyde and to subsequently form very stable covalent linkages with different protein groups (amino, thiol, phenolic) under very mild experimental conditions of pH and temperature, at low ionic buffer strength. It can also be used for enzyme immobilization by ionic interaction of the ionizable surface aminoacids (Lys, Arg, His, Asp, Glu) with the charged amines on the polymer. Lifetech ECR8309F main features are the medium porosity, the hydrophilicity and its optimal use in batch reactors. Sold in collaboration with Purolite for research purposes only.	50g 5x50g
07-1515 NEW	Enzyme carrier Lifetech™ ECR8309M White to off white spherical beads (wet); SA: 70 min. m ² /g <i>(store cold)</i> Note: Store in dry conditions (2-20°C). Do not freeze. Shelf Life: 5 years; Particle Size: 300-710 micron; Pore Diameter: 600-1200; Lifetech ECR8309M is a methacrylate polymer functionalised with amino groups on a short spacer (C2). It is used for covalent enzyme immobilization by pre-activation of the resin with glutaraldehyde and to subsequently form very stable covalent linkages with different protein groups (amino, thiol, phenolic) under very mild experimental conditions of pH and temperature, at low ionic buffer strength. It can also be used for enzyme immobilization by ionic interaction of the ionizable surface aminoacids (Lys, Arg, His, Asp, Glu) with the charged amines on the polymer. Lifetech ECR8309M main features are the medium porosity, the hydrophilicity and its optimal use in batch reactors and columns. Sold in collaboration with Purolite for research purposes only.	50g 5x50g
07-1518 NEW	Enzyme carrier Lifetech™ ECR8315F white to off white spherical beads (wet); SA: 60 min. m ² /g <i>(store cold)</i> Note: Store in dry conditions (2-20°C). Do not freeze. Shelf Life: 5 years; Particle Size: 150-300 micron; Pore Diameter: 1200-1800; Lifetech ECR8315F is a methacrylate polymer functionalised with amino groups on a short spacer (C2). It is used for covalent enzyme immobilization by pre-activation of the resin with glutaraldehyde and to subsequently form very stable covalent linkages with different protein groups (amino, thiol, phenolic) under very mild experimental conditions of pH and temperature, at low ionic buffer strength. Lifetech ECR8315F main features are the high porosity, the hydrophilicity and its optimal use in batch reactors. Sold in collaboration with Purolite for research purposes only.	50g 250g

BIOCATALYSTS (Compounds)

07-1520	Enzyme carrier Lifetech™ ECR8315M	50g
NEW	white to off white spherical beads (wet); SA: 60 min. m ² /g (store cold)	250g
<p>Note: Store in dry conditions (2-20°C). Do not freeze. Shelf Life: 5 years; Particle Size: 300-710 micron; Pore Diameter: 1200-1800; Lifetech ECR8315M is a methacrylate polymer functionalised with amino groups on a short spacer (C2). It is used for covalent enzyme immobilization by pre-activation of the resin with glutaraldehyde and to subsequently form very stable covalent linkages with different protein groups (amino, thiol, phenolic) under very mild experimental conditions of pH and temperature, at low ionic buffer strength. It can also be used for enzyme immobilization by ionic interaction of the ionizable surface aminoacids (Lys, Arg, His, Asp, Glu) with the charged amines on the polymer. Lifetech ECR8315M main features are the medium porosity, the hydrophilicity and its optimal use in batch reactors and columns. Sold in collaboration with Purolite for research purposes only.</p>		
07-1523	Enzyme carrier Lifetech™ ECR8409F	50g
NEW	white to off white spherical beads (wet); SA: 70 min. m ² /g (store cold)	250g
<p>Note: Store in dry conditions (2-20°C). Do not freeze. Shelf Life: 5 years; Particle Size: 150-300 micron; Pore Diameter: 600-1200; Lifetech ECR8409F is a methacrylate polymer functionalised with amino groups on a long spacer (C6). It is used for covalent enzyme immobilization by pre-activation of the resin with glutaraldehyde and to subsequently form very stable covalent linkages with different protein groups (amino, thiol, phenolic) under very mild experimental conditions of pH and temperature, at low ionic buffer strength. It can also be used for enzyme immobilization by ionic interaction of the ionizable surface aminoacids (Lys, Arg, His, Asp, Glu) with the charged amines on the polymer. Lifetech ECR8409F main features are the medium porosity, the hydrophilicity and its optimal use in batch reactors. Sold in collaboration with Purolite for research purposes only.</p>		
07-1525	Enzyme carrier Lifetech™ ECR8409M	50g
NEW	white to off white spherical beads (wet); SA: 70 min. m ² /g (store cold)	250g
<p>Note: Store in dry conditions (2-20°C). Do not freeze. Shelf Life: 5 years; Particle Size: 300-710 micron; Pore Diameter: 600-1200; Lifetech ECR8409M is a methacrylate polymer functionalised with amino groups on a long spacer (C6). It is used for covalent enzyme immobilization by pre-activation of the resin with glutaraldehyde and to subsequently form very stable covalent linkages with different protein groups (amino, thiol, phenolic) under very mild experimental conditions of pH and temperature, at low ionic buffer strength. It can also be used for enzyme immobilization by ionic interaction of the ionizable surface aminoacids (Lys, Arg, His, Asp, Glu) with the charged amines on the polymer. Lifetech ECR8409M main features are the medium porosity, the hydrophilicity and its optimal use in batch reactors and columns. Sold in collaboration with Purolite for research purposes only.</p>		
07-1528	Enzyme carrier Lifetech™ ECR8415F	50g
NEW	white to off white spherical beads (wet); SA: 60 min. m ² /g (store cold)	250g
<p>Note: Store in dry conditions (2-20°C). Do not freeze. Shelf Life: 5 years; Particle Size: 150-300 micron; Pore Diameter: 1200-1800; Lifetech ECR8415F is a methacrylate polymer functionalised with amino groups on a long spacer (C6). It is used for covalent enzyme immobilization by pre-activation of the resin with glutaraldehyde and to subsequently form very stable covalent linkages with different protein groups (amino, thiol, phenolic) under very mild experimental conditions of pH and temperature, at low ionic buffer strength. It can also be used for enzyme immobilization by ionic interaction of the ionizable surface aminoacids (Lys, Arg, His, Asp, Glu) with the charged amines on the polymer. Lifetech ECR8415F main features are the high porosity, the hydrophilicity and its optimal use in batch reactors. Sold in collaboration with Purolite for research purposes only.</p>		

BIOCATALYSTS (Compounds)

07-1530 NEW	Enzyme carrier Lifetech™ ECR8415M White to off white spherical beads (wet); SA: 60 min. m ² /g <i>(store cold)</i> Note: Store in dry conditions (2-20°C). Do not freeze. Shelf Life: 5 years; Particle Size: 300-710 micron; Pore Diameter: 1200-1800; Lifetech ECR8415M is a methacrylate polymer functionalised with amino groups on a long spacer (C6). It is used for covalent enzyme immobilization by pre-activation of the resin with glutaraldehyde and to subsequently form very stable covalent linkages with different protein groups (amino, thiol, phenolic) under very mild experimental conditions of pH and temperature, at low ionic buffer strength. It can also be used for enzyme immobilization by ionic interaction of the ionizable surface aminoacids (Lys, Arg, His, Asp, Glu) with the charged amines on the polymer. Lifetech ECR8415M main features are the high porosity, the hydrophilicity and its optimal use in batch reactors. Sold in collaboration with PuroLite for research purposes only.	50g 5x50g
07-1532 NEW	Enzyme carrier Lifetech™ ECR8806F White to off white spherical beads (wet); SA: 70 min. m ² /g <i>(store cold)</i> Note: Store in dry conditions (2-20°C). Do not freeze. Shelf Life: 5 years; Particle Size: 150-300 micron; Pore Diameter: 350-600; Lifetech ECR8806F is a methacrylic polymer functionalised with octadecyl groups. It is used for enzyme immobilization by adsorption (hydrophobic interaction) and it is particularly suitable for lipase and transaminases immobilization. Lifetech ECR8806F main features are very enzyme activity achieved upon immobilization compared to other existing resins. Sold in collaboration with PuroLite for research purposes only.	50g 5x50g
07-1535 NEW	Enzyme carrier Lifetech™ ECR8806M White to off white spherical beads (wet); SA: 70 min. m ² /g <i>(store cold)</i> Note: Store in dry conditions (2-20°C). Do not freeze. Shelf Life: 5 years; Particle Size: 300-710 micron; Pore Diameter: 350-600; Lifetech ECR8806M is a methacrylic polymer functionalised with octadecyl groups. It is used for enzyme immobilization by adsorption (hydrophobic interaction) and it is particularly suitable for lipase and transaminases immobilization. Lifetech ECR8806M main features are very high enzyme activity achieved upon immobilization compared to other existing resins. Optimal for column packed reactors. Sold in collaboration with PuroLite for research purposes only.	50g 5x50g
06-0820 NEW	Enzyme carrier Lifetech™ ECR8209M white to off white spherical beads (wet); SA: 70 min. m ² /g <i>(store cold)</i> Note: Store in dry conditions (2-8°C). Do not freeze. Shelf Life: 6 months; Particle Size: 300-710 micron; Pore Diameter: 600-1200; Lifetech ECR8209M is a methacrylate polymer functionalised with epoxy groups, used for covalent enzyme immobilization. Epoxy groups form very stable covalent linkages with different protein surface groups as ε-NH ₂ in Lys or nucleophiles (amino, thiol, phenolic). Immobilization is performed under very mild experimental conditions of pH and temperature, at high ionic buffer strength. Lifetech ECR8209M main features are the high porosity, the hydrophilicity and it is optimal use in batch reactors and columns.	50g 5x50g
06-0823 NEW	Enzyme carrier Lifetech™ ECR8215F white to off white spherical beads (wet); SA: 60 min. m ² /g <i>(store cold)</i> Note: Store in dry conditions (2-8°C). Do not freeze. Shelf Life: 6 months; Particle Size: 150-300 micron; Pore Diameter: 1200-1800; Lifetech ECR8215F is a methacrylate polymer functionalised with epoxy groups, used for covalent enzyme immobilization. Epoxy groups form very stable covalent linkages with different protein surface groups as ε-NH ₂ in Lys or nucleophiles (amino, thiol, phenolic). Immobilization is performed under very mild experimental conditions of pH and temperature, at high ionic buffer strength. Lifetech ECR8215F main features are the very high porosity, the hydrophilicity and it is optimal for use in batch reactors.	50g 5x50g

BIOCATALYSTS (Compounds)

06-0826 NEW	Enzyme carrier Lifetech™ ECR8215M white to off white spherical beads (wet); SA: 60 min. m ² /g (store cold) Note: Store in dry conditions (2-8°C). Do not freeze. Shelf Life: 6 months; Particle Size: 300-710 micron; Pore Diameter: 1200-1800; Lifetech ECR8215M is a methacrylate polymer functionalised with epoxy groups, used for covalent enzyme immobilization. Epoxy groups form very stable covalent linkages with different protein surface groups as ε-NH ₂ in Lys or nucleophiles (amino, thiol, phenolic). Immobilization is performed under very mild experimental conditions of pH and temperature, at high ionic buffer strength. Lifetech ECR8215M main features are the very high porosity, the hydrophilicity and its optimal use in batch reactors and columns.	50g 5x50g
06-0828 NEW	Enzyme carrier Lifetech™ ECR8285 white to off white spherical beads (wet); SA: 100-200 m ² /g (store cold) Note: Store in dry conditions (2-8°C). Do not freeze. Shelf Life: 6 months; Particle Size: 250-1000 micron; Pore Diameter: 400-600; Lifetech ECR8285 is a methacrylate polymer functionalised with both butyl and epoxy groups. This combination creates a good balance of hydrophobicity that makes the polymer optimal for immobilization of hydrophobic enzymes like lipases and transaminases. Epoxides form very stable covalent linkages with different protein groups (amino, thiol, phenolic) under very mild experimental conditions of pH and temperature. Lifetech ECR8285 main features are the process advantages deriving from hydrophobic property combined with epoxy groups allowing the use in bi-phasic systems. Sold in collaboration with Purolyte for research purposes only.	50g 5x50g
96-0255	Enzyme carrier Lifetech™ ECRKIT1 See page 540	
06-3115 NEW	Esperase® 8.0 L (9014-01-1) amber liq. (semitransparent); d. 1.07 (store cold) Note: Store at 0-10°C. DO NOT FREEZE. Declared activity 8KNPU-E/g. Serine endoprotease that hydrolyzes internal peptide bonds. Color can vary from batch to batch. Color intensity is not an indication of enzyme activity. Packaging must be kept intact, dry and away from sunlight. Please follow the recommendations and use the product before the best before date to avoid the need for a higher dosage. Sold in collaboration with Novozymes A/S. Novozymes does not promote nor support the use of enzymes as Active Pharmaceutical Ingredients or excipients. www.strem.com/novozymes	10g 50g 250g
96-4065	Lipase immo Kit - Immobilized enzymes See page 462	
06-3105 NEW	Lipozyme® CALB L (9001-62-1) yellow to light-brown liq.; d. 1.2 (store cold) Note: Store at 0-10°C. DO NOT FREEZE. Declared activity 5000 LU/g. Lipase that hydrolyzes ester bonds in glycerides. Color can vary from batch to batch. Color intensity is not an indication of enzyme activity. Packaging must be kept intact, dry and away from sunlight. Please follow the recommendations and use the product before the best before date to avoid the need for a higher dosage. Sold in collaboration with Novozymes A/S. Novozymes does not promote nor support the use of enzymes as Active Pharmaceutical Ingredients or excipients. www.strem.com/novozymes	10g 50g 250g
06-3140 NEW	Lipozyme® TL 100 L (9001-62-1) yellow liq.; d. 1.05 (store cold) Note: Store at 0-10°C. DO NOT FREEZE. Declared activity 100 KLU/g. Lipase that hydrolyzes ester bonds in glycerides. Color can vary from batch to batch. Color intensity is not an indication of enzyme activity. Packaging must be kept intact, dry and away from sunlight. Please follow the recommendations and use the product before the best before date to avoid the need for a higher dosage. Sold in collaboration with Novozymes A/S. Novozymes does not promote nor support the use of enzymes as Active Pharmaceutical Ingredients or excipients. www.strem.com/novozymes	10g 50g 250g

BIOCATALYSTS (Compounds)

06-3155 NEW	Lipozyme® TL IM (9001-62-1) off-white immobilized granulate; d. 0.4 (store cold) Note: Store at 0-10°C. DO NOT FREEZE. Declared activity 250 IUN/g. Lipase that hydrolyzes ester bonds in glycerides. It is a 1,3 specific lipase which is immobilized on a non-compressible silica gel carrier into an immobilized granulate. Sold in collaboration with Novozymes A/S. Novozymes does not promote nor support the use of enzymes as Active Pharmaceutical Ingredients or excipients. www.strem.com/novozymes	10g 50g 250g
06-3160 NEW	Neutrase® 0.8 L (9080-56-2) brown liq.; d. 1.26 (store cold) Note: Store at 0-10°C. DO NOT FREEZE. Declared activity 0.8 AU/g. Kinetic resolution of amino esters is a neutral, zinc metallo endoprotease, that randomly hydrolyzes internal peptide bonds and also facilitates enzymatic synthesis of oligopeptides by the reverse proteolysis reaction with zinc metal as co-catalyst. Sold in collaboration with Novozymes A/S. Novozymes does not promote nor support the use of enzymes as Active Pharmaceutical Ingredients or excipients. www.strem.com/novozymes	10g 50g 250g
06-3100 NEW	NovoCor® AD L (9001-62-1) brown liq.; d. 1.17 (store cold) Note: Store at 0-10°C. DO NOT FREEZE. Declared activity 6000 LU/g. Lipase that hydrolyzes ester bonds in glycerides. Color can vary from batch to batch. Color intensity is not an indication of enzyme activity. Packaging must be kept intact, dry and away from sunlight. Please follow the recommendations and use the product before the best before date to avoid the need for a higher dosage. Sold in collaboration with Novozymes A/S. Novozymes does not promote nor support the use of enzymes as Active Pharmaceutical Ingredients or excipients. www.strem.com/novozymes	10g 50g 250g
06-3123 NEW	Novozym® 435 (9001-62-1) off-white immobilized granulate; d. 0.4 (store cold) Note: Store at 0-10°C. DO NOT FREEZE. Declared activity 10000 PLU/g. Lipase that hydrolyzes ester bonds in glycerides. Color can vary from batch to batch. Color intensity is not an indication of enzyme activity. Packaging must be kept intact, dry and away from sunlight. Please follow the recommendations and use the product before the best before date to avoid the need for a higher dosage. Sold in collaboration with Novozymes A/S. Novozymes does not promote nor support the use of enzymes as Active Pharmaceutical Ingredients or excipients. www.strem.com/novozymes	5g 25g
06-3120 NEW	Novozym® 40086 (9001-62-1) brown immobilized granulate; d. 0.33 (store cold) Note: Store at 0-10°C. DO NOT FREEZE. Declared activity 275 IUN/g. Lipase that hydrolyzes ester bonds in glycerides. Color can vary from batch to batch. Color intensity is not an indication of enzyme activity. Packaging must be kept intact, dry and away from sunlight. Please follow the recommendations and use the product before the best before date to avoid the need for a higher dosage. Sold in collaboration with Novozymes A/S. Novozymes does not promote nor support the use of enzymes as Active Pharmaceutical Ingredients or excipients. www.strem.com/novozymes	5g 25g
06-3135 NEW	Novozym® 51032 (9001-62-1) yellow to light-brown liq.; d. 1.04 (store cold) Note: Store at 0-10°C. DO NOT FREEZE. Declared activity 15 KLU/g. Lipase that hydrolyzes ester bonds in glycerides. Product may be hazy and contain slight precipitate. This does not affect enzyme activity or performance. Color can vary from batch to batch. Color intensity is not an indication of enzyme activity. Packaging must be kept intact, dry and away from sunlight. Please follow the recommendations and use the product before the best before date to avoid the need for a higher dosage. Sold in collaboration with Novozymes A/S. Novozymes does not promote nor support the use of enzymes as Active Pharmaceutical Ingredients or excipients. www.strem.com/novozymes	10g 50g 250g

BIOCATALYSTS (Compounds)

96-0224	Novozymes Endoprotease Screening Kit (contains 6 endoprotease enzymes) See page 463	
96-0220	Novozymes Lipase Screening Kit (contains 9 lipase enzymes) See page 463	
06-3118 NEW	Palatase® 20000 L (9001-62-1) brown liq.; d. 1.19 (store cold) Note: Store at 0-10°C. DO NOT FREEZE. Declared activity 20000 LU-MM/g. Lipase that hydrolyzes ester bonds in glycerides. Color can vary from batch to batch. Color intensity is not an indication of enzyme activity. Packaging must be kept intact, dry and away from sunlight. Please follow the recommendations and use the product before the best before date to avoid the need for a higher dosage. Sold in collaboration with Novozymes A/S. Novozymes does not promote nor support the use of enzymes as Active Pharmaceutical Ingredients or excipients. www.strem.com/novozymes	5g 25g 100g
96-1580	Provivi Carbene/Nitrene Transferase Screening Kit See page 464	
06-3125 NEW	Resinase® HT (9001-62-1) yellow liq.; d. 1.05 (store cold) Note: Store at 0-10°C. DO NOT FREEZE. Declared activity 50 KLU/g. Lipase that hydrolyzes ester bonds in glycerides. Color can vary from batch to batch. Color intensity is not an indication of enzyme activity. Packaging must be kept intact, dry and away from sunlight. Please follow the recommendations and use the product before the best before date to avoid the need for a higher dosage. Sold in collaboration with Novozymes A/S. Novozymes does not promote nor support the use of enzymes as Active Pharmaceutical Ingredients or excipients. www.strem.com/novozymes	10g 50g 250g
06-3137 NEW	Savinase® 12 T (9014-01-1) off-white granulate; d. 1.3 (store cold) Note: Store at 0-10°C. DO NOT FREEZE. Declared activity 12 KNPU-S/g. Serine endoprotease that hydrolyzes internal peptide bonds. The granulate contains enzyme concentrate, inorganic salt, binder and coating materials. Color can vary from batch to batch. Color intensity is not an indication of enzyme activity. Packaging must be kept intact, dry and away from sunlight. Please follow the recommendations and use the product before the best date to avoid the need for a higher dosage. Sold in collaboration with Novozymes A/S. Novozymes does not promote nor support the use of enzymes as Active Pharmaceutical Ingredients or excipients. www.strem.com/novozymes	10g 50g 250g
06-3150 NEW	Savinase® 16 L (9014-01-1) amber liq. (semitransparent); d. 1.16 (store cold) Note: Store at 0-10°C. DO NOT FREEZE. Declared activity 16 KNPU-S/g. A serine endoprotease that hydrolyzes internal peptide bonds. Color can vary from batch to batch. Color intensity is not an indication of enzyme activity. Packaging must be kept intact, dry and away from sunlight. Please follow the recommendations and use the product before the best before date to avoid the need for a higher dosage. Sold in collaboration with Novozymes A/S. Novozymes does not promote nor support the use of enzymes as Active Pharmaceutical Ingredients or excipients. www.strem.com/novozymes	10g 50g 250g
BISMUTH (Elemental Forms)		
83-0050	Bismuth granules (99.9999%) (7440-69-9) Bi; FW: 208.98; 1-3 mm; m.p. 271.3°; b.p. 1560°; d. 9.80	10g 50g 250g
83-0075	Bismuth pieces (99.99%) (7440-69-9) Bi; FW: 208.98; hemispheres (~10g/piece); m.p. 271.3°; b.p. 1560°; d. 9.80	250g 1kg
93-8345 HAZ	Bismuth powder (99.5%) (7440-69-9) Bi; FW: 208.98; -200 mesh; m.p. 271.3°; b.p. 1560°; d. 9.80	100g 500g

BISMUTH (Elemental Forms)

93-8347	Bismuth powder (99.9%) (7440-69-9)	50g
HAZ	Bi; FW: 208.98; -200 mesh; m.p. 271.3°; b.p. 1560°; d. 9.80	250g
93-8348	Bismuth powder (99.999%) (7440-69-9)	10g
HAZ	Bi; FW: 208.98; -200 mesh; m.p. 271.3°; b.p. 1560°; d. 9.80	50g
83-0080	Bismuth rod (99.9999%) (7440-69-9)	25g
	Bi; FW: 208.98; 10mm dia. (~7.7g/cm); m.p. 271.3°; b.p. 1560°; d. 9.80	100g
93-8346	Bismuth shot, elongated (99.99%) (7440-69-9)	100g
	Bi; FW: 208.98; ~1.5-2mm dia. x 3-4mm long; m.p. 271.3°; b.p. 1560°; d. 9.80	500g
83-0085	Bismuth shot, elongated (99.999%) (7440-69-9)	100g
	Bi; FW: 208.98; 1-3mm dia.; m.p. 271.3°; b.p. 1560°; d. 9.80	500g

BISMUTH (Compounds)

93-8352	Bismuth(III) acetate, 99% (22306-37-2)	25g
	Bi(OOCC ₂ H ₃) ₃ ; FW: 386.12; white xtl. <i>moisture sensitive</i>	100g
93-8313	Bismuth(III) bromide, 98+% (7787-58-8)	10g
HAZ	BiBr ₃ ; FW: 448.71; yellow powdr.; m.p. 218°; b.p. 453° <i>moisture sensitive</i>	50g
93-8314	Bismuth(III) chloride, anhydrous, 99+% (99.9+%Bi) (7787-60-2)	25g
	BiCl ₃ ; FW: 315.34; white xtl.; m.p. 230-232°; b.p. 447°; d. 4.75 <i>moisture sensitive</i>	100g
93-8315	Bismuth(III) chloride, anhydrous (99.999%-Bi) PURATREM (7787-60-2)	5g
	BiCl ₃ ; FW: 315.34; white xtl.; m.p. 230-232°; b.p. 447°; d. 4.75 <i>moisture sensitive</i>	25g
83-2415	Bismuth(III) 2-ethylhexanoate, ~30% wt/wt Bi in 2-ethylhexanoic acid (99.98%-Bi) (67874-71-9)	50g
	Bi[OOCC(C ₂ H ₅)C ₄ H ₉] ₃ ; FW: 638.61; liq.	250g
83-2400	Bismuth(III) 2-ethylhexanoate, 72% in mineral spirits (~28% Bi) (67874-71-9)	250g
	Bi[OOCC(C ₂ H ₅)C ₄ H ₉] ₃ ; FW: 638.61; brown liq.; f.p. 162°F; d. 1.28	1kg
83-2401	Bismuth(III) 2-ethylhexanoate, 70-75% in xylenes (~24% Bi) (99.99+%Bi) PURATREM (67874-71-9)	25g
HAZ	Bi[OOCC(C ₂ H ₅)C ₄ H ₉] ₃ ; FW: 638.61; light yellow liq.	100g
93-8316	Bismuth(III) fluoride anhydrous, 99% (7787-61-3)	25g
	BiF ₃ ; FW: 265.98; off-white powdr.; m.p. 727°; d. 5.32 <i>moisture sensitive</i>	100g
83-3000	Bismuth(III) fluoride (99.99+%Bi) PURATREM (7787-61-3)	10g
	BiF ₃ ; FW: 265.98; white to gray xtl.; m.p. 727°; d. 5.32 <i>moisture sensitive</i>	50g
93-8317	Bismuth(III) iodide (99.999%-Bi) PURATREM (7787-64-6)	5g
HAZ	BiI ₃ ; FW: 589.69; gray powdr.; m.p. 408°; b.p. ~500°; d. 5.778 <i>moisture sensitive</i>	25g
83-7000	Bismuth(III) neodecanoate, superconductor grade ~60% in neodecanoic acid (15-20% Bi) (34364-26-6)	10g
	Bi(OOCC ₉ H ₁₉ -neo) ₃ ; FW: 722.71; viscous liq.	50g
		250g
93-8304	Bismuth(III) nitrate pentahydrate, 98% (ACS) (10035-06-0)	250g
HAZ	Bi(NO ₃) ₃ ·5H ₂ O; FW: 394.99 (485.07); white xtl.; m.p. 30°; d. 2.83 <i>hygroscopic</i>	1kg
93-8303	Bismuth(III) nitrate pentahydrate (99.999%-Bi) PURATREM (10035-06-0)	5g
HAZ	Bi(NO ₃) ₃ ·5H ₂ O; FW: 394.99 (485.07); white xtl.; d. 2.83 <i>moisture sensitive</i>	25g
		100g
93-8318	Bismuth(III) oxide (99.9%-Bi) (1304-76-3)	100g
	Bi ₂ O ₃ ; FW: 465.96; yellow powdr.; m.p. 817°; b.p. 1890°; d. 8.9	500g
93-8319	Bismuth(III) oxide (99.999%-Bi) PURATREM (1304-76-3)	25g
	Bi ₂ O ₃ ; FW: 465.96; yellow powdr.; m.p. 817°; b.p. 1890°; d. 8.9	100g
		500g
83-4025	Bismuth(III) oxide (99.9998%-Bi) PURATREM (1304-76-3)	25g
	Bi ₂ O ₃ ; FW: 465.96; yellow powdr.; m.p. 817°; b.p. 1890°; d. 8.9	100g
93-8309	Bismuth(III) sulfide (99.9%-Bi) (1345-07-9)	25g
	Bi ₂ S ₃ ; FW: 514.15; -200 mesh gray to black powdr.; m.p. 685° dec.; d. 7.39	100g

BISMUTH (Compounds)

93-8351	Bismuth(III) sulfide (99.999%-Bi) PURATREM (1345-07-9) Bi ₂ S ₃ ; FW: 514.15; gray to black powdr.; m.p. 685° dec.; d. 7.39	10g 50g
83-4075	Bismuth(III) telluride (99.99%-Bi) PURATREM (1304-82-1) Bi ₂ Te ₃ ; FW: 800.76; black powdr.; m.p. 573°	5g 25g
93-8312	Bismuth(III) titanate, 98% (12048-51-0) Bi ₂ Ti ₂ O ₇ ; FW: 625.76; white powdr.	25g 100g
83-8000	Bismuth(III) trifluoromethanesulfonate, min. 98% (Bismuth triflate) (88189-03-1) Bi(SO ₃ CF ₃) ₃ ; FW: 656.19; white to off-white powdr. <i>hygroscopic</i>	1g 5g 25g

Technical Note:

1. Powerful Lewis acid useful in a number of catalytic reactions.

References:

1. *Synlett*, **2003**, *10*, 1566

93-8350	Triphenylbismuth, 99% (603-33-8) (C ₆ H ₅) ₂ Bi; FW: 440.30; white xtl.; m.p. 77-78°; b.p. dec. 310° (subl. 100°/0.2mm); d. 1.585 Note: For sale in USA. For other countries contact Strem.	10g 50g
83-1000	Tris(2,2,6,6-tetramethyl-3,5-heptanedionato)bismuth(III), min. 98% (99.9%-Bi) [Bi(TMHD)₃] (142617-53-6) Bi(C ₁₁ H ₁₉ O ₂) ₃ ; FW: 758.74; off-white xtl.; m.p. 114-116°; b.p. dec. 295° (subl. 150°/0.05mm)	1g 5g 25g

BORON (Elemental Forms)

93-0581 HAZ	Boron powder, amorphous (93-96%) (7440-42-8) B; FW: 10.81; 0.4-0.7 microns; m.p. 2300°; b.p. 2550°; d. 2.34-2.37 Note: For sale in USA. For other countries contact Strem.	10g 50g
05-0050 HAZ	Boron powder, amorphous (min. 98%) (7440-42-8) B; FW: 10.81; < 1 micron; m.p. 2300°; b.p. 2550°; d. 2.34-2.37 Note: For sale in USA. For other countries contact Strem.	10g 50g
93-0580 HAZ	Boron powder, crystalline (99.4%) (7440-42-8) B; FW: 10.81; 1-20mm pieces; m.p. 2300°; b.p. 2550°; d. 2.34-2.37	5g 25g
05-0065 HAZ	Boron powder, crystalline (99.99%) (7440-42-8) B; FW: 10.81; -4 + 40 mesh; m.p. 2300°; b.p. 2550°; d. 2.34-2.37	250mg 1g
05-0055 HAZ	Boron powder, crystalline, elec. gr. (99.9999%) (7440-42-8) B; FW: 10.81; -4 + 40 mesh; m.p. 2300°; b.p. 2550°; d. 2.34-2.37	250mg 1g 5g

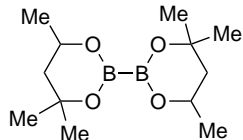
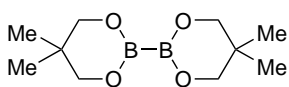
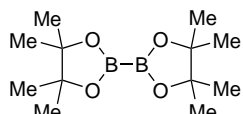

BORON (Compounds)

96-0350	Biological Hydrogen Peroxide Imaging Kit (FBBBE, CBBE) See page 537		
05-0020	Bis(hexyleneglycolato)diboron, 99% (230299-21-5) C ₁₂ H ₂₄ B ₂ O ₄ ; FW: 253.94; white powdr.; m.p. 98-101°		1g 5g
05-0025	Bis(neopentylglycolato)diboron, min. 97% (201733-56-4) C ₁₀ H ₂₀ B ₂ O ₄ ; FW: 225.89; white xtl.; m.p. 182-185° <i>moisture sensitive</i>		1g 5g 25g
05-0030	Bis(pinacolato)diboron, 99% (73183-34-3) C ₁₂ H ₂₄ B ₂ O ₄ ; FW: 253.94; white to off-white xtl.; m.p. 144-145°; d. 0.98 <i>moisture sensitive</i> For detailed technical note visit strem.com .		500mg 2g 10g 50g 500g

BORON (Compounds)

05-0058	3',6'-Bis[[4-(4,4,5,5-tetramethyl-1,3,2-dioxaborolan-2-yl)oxy]-3H-[spiro(isobenzofuran-1,9-xanthen)-3-one] FBBBE (1522117-83-4) C ₄₆ H ₄₆ B ₂ O ₉ ; FW: 764.47; faint yellow powdr. <i>light sensitive, (store cold)</i> Note: Sold under license from The Regents of the University of California. US Patent application 61/762,706. Biological Hydrogen Peroxide Imaging Kit (FBBBE, CBBE) component.	5mg
05-0101	Borane, t-butylamine complex, powder, min. 97% (7337-45-3) (CH ₃) ₃ CNH ₂ ·BH ₃ ; FW: 86.97; white powdr.; m.p. 98° dec.	25g 100g
93-0554	Borane, dimethylamine complex, min. 97% (74-94-2) (CH ₃) ₂ NH·BH ₃ ; FW: 58.92; white xtl.; m.p. 36°; b.p. 59-65°/1-2 mm; d. 0.69 <i>moisture sensitive, (store cold)</i>	10g 50g
05-0110	Borane, dimethylsulfide complex (contains 5-6% excess dimethylsulfide) (13292-87-0) (CH ₃) ₂ S·BH ₃ ; FW: 75.97; colorless liq.; m.p. -40°; f.p. 65°F; d. 0.801 <i>moisture sensitive, (store cold)</i>	25g 100g
93-0535	Borane, pyridine complex, min. 93% (110-51-0) C ₅ H ₅ N·BH ₃ ; FW: 92.94; colorless liq.; m.p. 10-11°; b.p. 65°/1 mm; f.p. 70°F; d. 0.92 <i>moisture sensitive</i>	10g 50g
93-0504	Boric acid, 99.8% (10043-35-3) H ₃ BO ₃ ; FW: 61.83; white xtl.; m.p. 171°; d. 1.435	500g 2kg
93-0559	Boric acid (99.99%-B) PURATREM (10043-35-3) H ₃ BO ₃ ; FW: 61.83; white xtl.; m.p. 171°; d. 1.435	250g 1kg
05-0205	Boric acid (99.9995%-B) PURATREM (10043-35-3) H ₃ BO ₃ ; FW: 61.83; white xtl.; m.p. 171°; d. 1.435	10g 50g
93-0514	Boron bromide, 99+% (10294-33-4) BBr ₃ ; FW: 250.54; pale yellow to orange liq.; m.p. -46°; b.p. 91.3°; d. 2.6431 <i>moisture sensitive, (store cold)</i>	25g 100g 500g
97-1725	Boron bromide, elec. gr. (99.999%-B) PURATREM (10294-33-4) BBr ₃ ; FW: 250.54; pale yellow to orange liq.; m.p. -46°; b.p. 91.3°; d. 2.6431 <i>moisture sensitive</i>	5g 25g 100g
93-0509	Boron carbide, powder, 99+% (12069-32-8) B ₄ C; FW: 55.26; -325 mesh gray to black powdr.; m.p. 2350°; b.p. > 3500°; d. 2.52 Note: For sale in USA. For other countries contact Strem.	50g 250g
05-0120	Boron carbide, 0.1-1.5 microns (99.9+%-B) (12069-32-8) B ₄ C; FW: 55.26; gray to black powdr.; SA: 22-27 m ² /g; m.p. 2350°; b.p. >3500°; d. 2.52 Note: For sale in USA. For other countries contact Strem. For detailed technical note visit strem.com .	100g 500g
93-0517	Boron fluoride, acetic acid complex, min. 97% (373-61-5) BF ₃ ·2CH ₃ COOH; FW: 187.91; colorless to pale yellow liq.; m.p. -47°; f.p. 181.4°F; d. 1.353 <i>moisture sensitive</i>	100g 500g
93-0519	Boron fluoride, ethyl ether complex (47-48% Boron fluoride) (109-63-7) BF ₃ ·O(C ₂ H ₅) ₂ ; FW: 141.94; pale yellow liq.; b.p. 126°; f.p. 118°F; d. 1.125 (25°) <i>moisture sensitive</i>	100g 500g

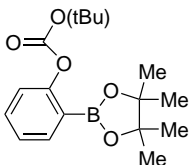
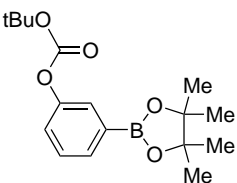
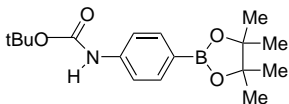
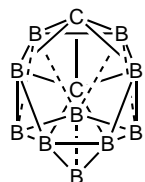
BORON (Compounds)

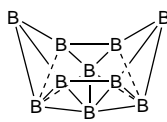
93-0512	Boron nitride, 99+% (10043-11-5) BN; FW: 24.82; off-white powdr.; d. 2.25	25g 100g
05-0125	Boron nitride, hexagonal crystalline solid, min. 99% (10043-11-5) BN; FW: 24.82; off-white powdr.	50g 250g
93-0526	Boron oxide (99.6%-B) (1303-86-2) B ₂ O ₃ ; FW: 69.62; white powdr.; m.p. 450°; b.p. ~1860°; d. 2.46 <i>hygroscopic</i>	250g 1kg
93-0527	Boron oxide (99.9+% -B) (1303-86-2) B ₂ O ₃ ; FW: 69.62; white powdr.; m.p. 450°; b.p. ~1860°; d. 2.46 <i>hygroscopic</i>	50g 250g
05-0370	t-Butyl-2-(4,4,5,5-tetramethyl-1,3,2-dioxaborolan-2-yl) phenyl carbonate, min. 97% (480424-71-3) C ₁₇ H ₂₅ BO ₅ ; FW: 320.19; pale yellow powdr.; m.p. 74-76°	1g 5g
		
05-0380	t-Butyl-3-(4,4,5,5-tetramethyl-1,3,2-dioxaborolan-2-yl)phenyl carbonate, min. 97% (480438-74-2) C ₁₇ H ₂₅ BO ₅ ; FW: 320.19; white powdr.; m.p. 86-88°	1g 5g
		
05-0360	t-Butyl-N-[4-(4,4,5,5-tetramethyl-1,3,2-dioxaborolan-2-yl)phenyl]carbamate, min. 97% (330793-01-6) C ₁₇ H ₂₆ BNO ₄ ; FW: 319.20; white xtl.; m.p. 169-170°	1g 5g
		
05-0300	o-Carborane, min. 95% (16872-09-6) 1,2-H ₂ C ₂ B ₁₀ H ₁₀ ; FW: 144.22; white powdr.; m.p. 285-287° Note: For sale in USA. For other countries contact Strem.	1g 5g
		
05-0399	3-Carboxyphenylboronic acid, min. 97% (25487-66-5) HOOC ₆ H ₄ B(OH) ₂ ; FW: 165.94; white to off-white powdr.	1g 5g
05-0400	4-Carboxyphenylboronic acid, min. 97% (14047-29-1) HOOC ₆ H ₄ B(OH) ₂ ; FW: 165.94; white to off-white powdr.; m.p. 238-240°	1g 5g
55-5525	Cesium carborane (12539-26-3) See page 43	
55-1800	Cesium dodecahydrododecaborate, min. 98% (12008-75-2) See page 43	
05-0430	4-Chlorophenylboronic acid, min. 97% (1679-18-1) ClC ₆ H ₄ B(OH) ₂ ; FW: 156.38; white to off-white powdr.; m.p. 284-289°	5g 25g
05-0440	Cyclopropylboronic acid, min. 97% (411235-57-9) (C ₃ H ₅) ₂ B(OH) ₂ ; FW: 85.90; white powdr. <i>moisture sensitive</i>	1g 5g
		
05-0500	Decaborane, min. 97% (17702-41-9) HAZ B ₁₀ H ₁₄ ; FW: 122.21; white xtl.; m.p. 100°; b.p. 213°; d. 0.94 (store cold) Note: For sale in USA. For other countries contact Strem.	250mg 1g
		

BORON (Compounds)

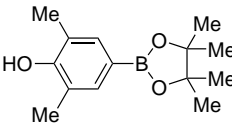
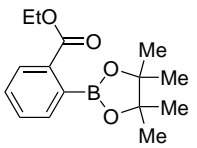
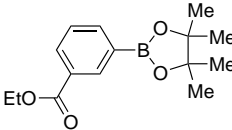
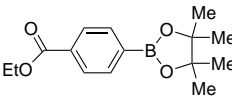
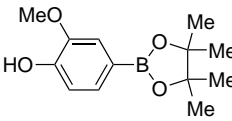
05-0750	N,N-Dimethylanilinium tetra(pentafluorophenyl)borate, 98% (118612-00-3) [C ₆ H ₅ N(CH ₃) ₂ H] ⁺ [B(C ₆ F ₅) ₄] ⁻ ; FW: 801.23; white to off-white powder. <i>hygroscopic</i>		250mg 1g 5g
05-0760	2,6-Dimethyl-4-(4,4,5,5-tetramethyl-1,3,2-dioxaborolan-2-yl)phenol, min. 97% (269410-25-5) C ₁₄ H ₂₁ BO ₃ ; FW: 248.13; yellow solid; m.p. 105-109°		1g 5g
05-0770	Ethyl-2-(4,4,5,5-tetramethyl-1,3,2-dioxaborolan-2-yl)benzoate, min. 97% (269409-99-6) C ₁₅ H ₂₁ BO ₄ ; FW: 276.14; white to yellow powder.; m.p. 55-58°		1g 5g
05-0775	Ethyl-3-(4,4,5,5-tetramethyl-1,3,2-dioxaborolan-2-yl)benzoate, min. 97% (269410-00-6) C ₁₅ H ₂₁ BO ₄ ; FW: 276.14; white powder.; m.p. 41-42°		1g 5g
05-0765	Ethyl-4-(4,4,5,5-tetramethyl-1,3,2-dioxaborolan-2-yl)benzoate, min. 97% (195062-62-5) C ₁₅ H ₂₁ BO ₄ ; FW: 276.14; colorless to pale yellow liquid.; b.p. 105-115°/0.01mm; d. 1.052		1g 5g
05-0800	4-Fluorophenylboronic acid, min. 97% (1765-93-1) FC ₆ H ₄ B(OH) ₂ ; FW: 139.92; white to off-white powder.; m.p. 263-265°		5g 25g
05-0780	Hexylboronic acid, min. 97% (16343-08-1) CH ₃ (CH ₂) ₅ B(OH) ₂ ; FW: 130.00; white to off-white powder.		5g 25g
05-0878	2-Methoxyphenylboronic acid, min. 97% (5720-06-9) CH ₃ OC ₆ H ₄ B(OH) ₂ ; FW: 151.96; white to off-white powder.		5g 25g
05-0880	4-Methoxyphenylboronic acid, min. 97% (5720-07-0) CH ₃ OC ₆ H ₄ B(OH) ₂ ; FW: 151.96; white to off-white powder.; m.p. 204-206°		5g 25g
05-0950	2-Methoxy-4-(4,4,5,5-tetramethyl-1,3,2-dioxaborolan-2-yl)phenol, min. 97% (269410-22-2) C ₁₃ H ₁₉ BO ₄ ; FW: 250.11; white to off-white powder.; m.p. 104-107°		1g 5g
05-1010	4-(Methylthiophenyl)boronic acid, min. 97% (98546-51-1) CH ₃ SC ₆ H ₄ B(OH) ₂ ; FW: 168.02; white to off-white powder.; m.p. 210-214°		1g 5g
05-1030	1-Naphthylboronic acid, min. 97% (13922-41-3) C ₁₀ H ₇ B(OH) ₂ ; FW: 171.99; white to off-white powder.; m.p. 210-211°		1g 5g
93-0740	Nitronium tetrafluoroborate, min. 97% (13826-86-3) See page 204		
93-0724	Nitrosonium tetrafluoroborate, min. 97% (14635-75-7) See page 204		
93-0533	Phenylboron dichloride, min. 97% (873-51-8) HAZ C ₆ H ₅ BCl ₂ ; FW: 158.83; colorless liquid.; m.p. 7°; b.p. 175°; f.p. -5°F; d. 1.194 (20°) <i>moisture sensitive</i>		1g 5g 25g
93-0570	Phenylboronic acid, min. 97% (98-80-6) C ₆ H ₅ B(OH) ₂ ; FW: 121.94; white to off-white powder.; m.p. 215°		10g 50g
19-1500	Potassium allyltrifluoroborate, 99% (233664-53-4) See page 340		
19-1800	Potassium dodecahydrododecaborate hydrate, min. 98% (874881-81-9) See page 341		

BORON (Compounds)

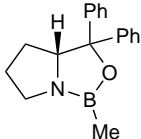
19-1965	Potassium tri-sec-butylborohydride, 1.0M in THF, in Sure/Seal™ bottle (54575-49-4) See page 345	
11-2800	Sodium cyanoborohydride, 95% (25895-60-7) See page 417	
11-0575	Sodium tetraethylborate, min. 98% (15523-24-7) See page 421	
93-1189	Sodium tetrafluoroborate, 98% (13755-29-8) See page 421	
11-0590	Sodium tetrakis[3,5-bis(trifluoromethyl)phenyl]borate, min. 98% NaBARF (79060-88-1) See page 421	
93-0571	Sodium tetraphenylborate, 99.5+% (ACS) (143-66-8) See page 421	
11-0595	Sodium triacetoxycyborohydride, min. 95% (56553-60-7) See page 421	
93-0503	Tetrafluoroboric acid, 48% aqueous solution (16872-11-0)	500g 4 x 500g
HAZ	HBF ₄ ; FW: 87.81; colorless to light yellow liq.	
05-1000	(R)-Tetrahydro-1-methyl-3,3-diphenyl-1H,3H-pyrrolo[1,2-c] [1,3,2]oxazaborole, 0.9-1.1M in toluene [(R)-Methyloxazaboro- lidine] (R)-CBS Catalyst (112022-83-0) C ₁₆ H ₂₀ BNO; FW: 277.17; liq.; f.p. 40°F (toluene); d. 0.925 moisture sensitive	10ml 50ml
HAZ		

Technical Notes:

- Convenient catalyst for the enantioselective borane reduction of ketones at ambient temperatures.
- Asymmetric synthesis of α-chiral hydroxyalkylphosphines via a catalytic, enantioselective reduction of acylphosphines.
- Nickel-catalyzed cross-couplings of benzylic pivalates with arylboroxines: Stereospecific formation of diarylalkanes and triarylmethanes.
- Enantioselective reduction of prochiral ketones with NaBH₄/Me₂SO₄/(S)-Me-CBS.

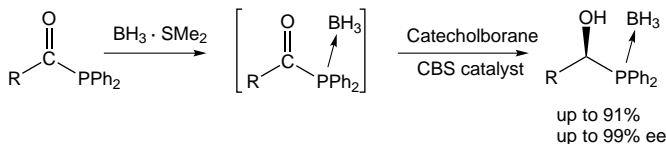

Tech. Note (2)
Ref. (1)

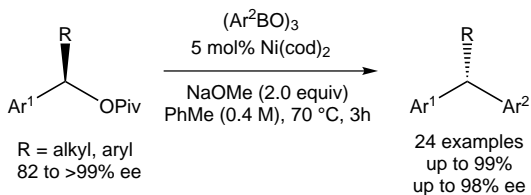

Tech. Note (3)
Ref. (2)

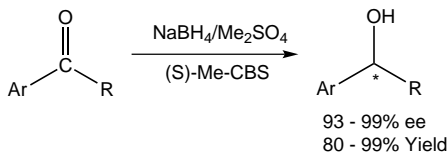

Tech. Note (4)
Ref. (3)

References:

- Org. Lett., **2014**, 16, 5830
- J. Am. Chem. Soc., **2013**, 135, 3307
- Synthetic Commun., **2014**, 44, 1515

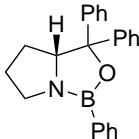
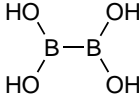
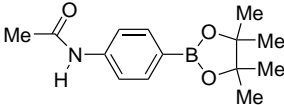
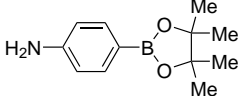
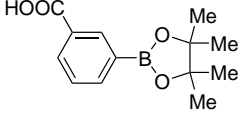
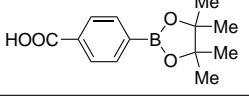
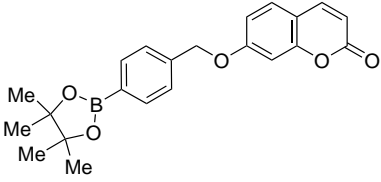
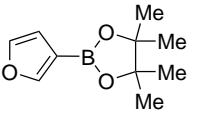

BORON (Compounds)

05-1001 HAZ	(S)-Tetrahydro-1-methyl-3,3-diphenyl-1H,3H-pyrrolo[1,2-c][1,3,2]oxazaborole, 0.9-1.1M in toluene [(S)-Methylloxazaborolidine] (S)-CBS Catalyst (112022-81-8) C ₁₈ H ₂₀ BNO; FW: 277.17; liq.; f.p. 40°F (toluene); d. 0.925 <i>moisture sensitive</i>		10ml 50ml
05-1002	(R)-Tetrahydro-1,3,3-triphenyl-1H,3H-pyrrolo[1,2-c][1,3,2]oxaborole, 99% (R)-Phenyl oxazaborolidine (145238-45-5) C ₂₃ H ₂₂ BNO; FW: 339.24; white to off-white powdr. <i>moisture sensitive</i> Note: **Limited quantity available**. For detailed technical note visit strem.com .		5g
05-1015	Tetrahydroxydiboron, min. 95% (13675-18-8) (OH) ₂ BB(OH) ₂ ; FW: 89.65; white solid; m.p. 143-148° <i>moisture sensitive</i> For detailed technical note visit strem.com .		1g 5g 25g
05-1035	Tetrakis(dimethylamino)diboron, min. 97% (1630-79-1) B ₂ (N(CH ₃) ₂) ₄ ; FW: 197.93; colorless liq.; b.p. 55-57° (2.5mm); f.p. 99°C; d. 0.926 <i>moisture sensitive</i>		1g 5g
05-1032	4-(4,4,5,5-Tetramethyl-1,3,2-dioxaborolan-2-yl)acetanilide, min. 97% (214360-60-8) C ₁₄ H ₂₀ BNO ₃ ; FW: 261.13; white powdr.; m.p. 165-167°		1g 5g
05-1034	4-(4,4,5,5-Tetramethyl-1,3,2-dioxaborolan-2-yl)aniline, min. 97% (214360-73-3) C ₁₂ H ₁₈ BNO ₂ ; FW: 219.09; beige powdr.; m.p. 167-171°		1g 5g
05-1036	3-(4,4,5,5-Tetramethyl-1,3,2-dioxaborolan-2-yl)benzoic acid, min. 97% (269409-73-6) C ₁₃ H ₁₇ BO ₄ ; FW: 248.09; white powdr.; m.p. 208-212°		1g 5g
05-1037	4-(4,4,5,5-Tetramethyl-1,3,2-dioxaborolan-2-yl)benzoic acid, min. 97% (180516-87-4) C ₁₃ H ₁₇ BO ₄ ; FW: 248.09; white to yellow powdr.; m.p. 229-231°		1g 5g
05-0054	7-[[[(4,4,5,5-Tetramethyl-1,3,2-dioxaborolan-2-yl)benzyl]oxy]-2H-1-benzopyran-2-one CBBE (1522117-80-1) C ₂₂ H ₂₃ BO ₅ ; FW: 378.23; white powdr. <i>light sensitive, (store cold)</i> Note: Sold under license from The Regents of the University of California. US Patent application 61/762,706. Biological Hydrogen Peroxide Imaging Kit (FBBBE, CBBE) component.		5mg
05-1039	3-(4,4,5,5-Tetramethyl-1,3,2-dioxaborolan-2-yl)furan, min. 97% (248924-59-6) C ₁₀ H ₁₅ BO ₃ ; FW: 194.04; white xtl.; m.p. 63-64°		1g 5g

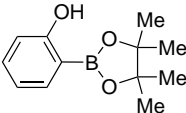
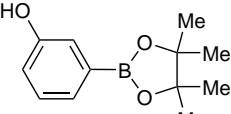
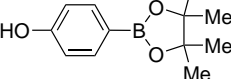
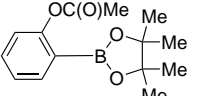
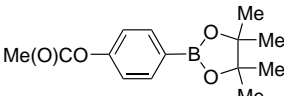
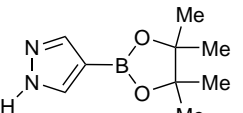
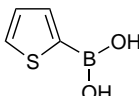
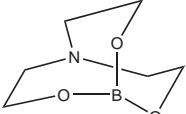
BORON (Compounds)

05-1042	2-(4,4,5,5-Tetramethyl-1,3,2-dioxaborolan-2-yl)phenol, min. 97% (269409-97-4) C ₁₂ H ₁₇ BO ₃ ; FW: 220.08; pale yellow liq.; b.p. 100°/0.2mm		1g 5g
05-1043	3-(4,4,5,5-Tetramethyl-1,3,2-dioxaborolan-2-yl)phenol, min. 97% (214360-76-6) C ₁₂ H ₁₇ BO ₃ ; FW: 220.08; pale yellow powdr.; m.p. 96-98°		1g 5g
05-1044	4-(4,4,5,5-Tetramethyl-1,3,2-dioxaborolan-2-yl)phenol, min. 97% (269409-70-3) C ₁₂ H ₁₇ BO ₃ ; FW: 220.08; pale yellow powdr.; m.p. 114-116°		1g 5g
05-1045	2-(4,4,5,5-Tetramethyl-1,3,2-dioxaborolan-2-yl)phenyl acetate, min. 97% (480424-68-8) C ₁₄ H ₁₉ BO ₄ ; FW: 262.14; colorless xtl.; m.p. 46-48°		1g 5g
05-1047	4-(4,4,5,5-Tetramethyl-1,3,2-dioxaborolan-2-yl)phenyl acetate, min. 97% (480424-70-2) C ₁₄ H ₁₉ BO ₄ ; FW: 262.14; white to yellow powdr.; m.p. 71-73°		1g 5g
05-1048	4-(4,4,5,5-Tetramethyl-1,3,2-dioxaborolan-2-yl)-1H-pyrazole, min. 97% (269410-08-4) C ₉ H ₁₃ BN ₂ O ₂ ; FW: 194.04; off-white to tan powdr.		1g 5g
05-1040	2-Thiopheneboronic acid, min. 97% (6165-68-0) C ₄ H ₃ SB(OH) ₂ ; FW: 127.96; white to off-white powdr.; m.p. 138-140° (store cold)		5g 25g
05-1049	m-Tolylboronic acid, min. 97% (17933-03-8) CH ₃ C ₆ H ₄ B(OH) ₂ ; FW: 135.96; white to off-white powdr.; m.p. 160-162°		5g 25g
05-1050	o-Tolylboronic acid, min. 97% (16419-60-6) CH ₃ C ₆ H ₄ B(OH) ₂ ; FW: 135.96; white to off-white powdr.; m.p. 162-164°		5g 25g
05-1051	p-Tolylboronic acid, min. 97% (5720-05-8) CH ₃ C ₆ H ₄ B(OH) ₂ ; FW: 135.96; white to off-white powdr.; m.p. 248-250°		5g 25g
05-1100	B-Tribromoborazine, min. 95% (13703-88-3) HAZ (BBrNH) ₃ ; FW: 317.20; white powdr. <i>moisture sensitive</i>		1g 5g
93-0528	Tri-n-butylborate, 98% (688-74-4) B(OC ₄ H ₉) ₃ ; FW: 230.16; colorless liq.; m.p. -70°; b.p. 230-235°; f.p. 200°F; d. 0.853 <i>moisture sensitive</i>		100g 500g
93-0568	B-Trichloroborazine, min. 95% (933-18-6) HAZ (ClBNH) ₃ ; FW: 183.84; white powdr.; m.p. 84°; d. 1.58 <i>moisture sensitive</i>		250mg 1g 5g
93-0538	Triethanolamineborate, min. 95% (283-56-7) B(OCH ₂ CH ₂) ₃ N; FW: 156.98; white powdr.; m.p. 235-237°		25g 100g

BORON (Compounds)

93-0540 HAZ 	Triethylborane, 98% (97-94-9) B(C ₂ H ₅) ₃ ; FW: 98.00; colorless liq.; m.p. -92.9°; b.p. 95°; f.p. 32.8°F; d. 0.6961 (23°) <i>pyrophoric</i>	100g
93-0530 HAZ	Triethylborate, 98.5+% (150-46-9) B(OC ₂ H ₅) ₃ ; FW: 146.00; colorless liq.; m.p. -84.8°; b.p. 117.4°; f.p. 52°F; d. 0.864 <i>moisture sensitive</i>	100g 500g
93-0574 HAZ	Trimethoxyboroxine, min. 95% (102-24-9) (CH ₃ O) ₃ B ₃ O ₃ ; FW: 173.6; colorless, slightly opaque liq.; m.p. 10-11°; f.p. 50°F; d. 1.216 <i>moisture sensitive</i>	100g 500g
93-0567 HAZ 	Trimethylborane, 98% (593-90-8) (CH ₃) ₃ B; FW: 55.92; colorless gas; m.p. -161.5°; b.p. -20.2°; d. 0.625 (-100°) <i>pyrophoric</i>	25g
93-0531 HAZ	Trimethylborate, 98% (121-43-7) B(OCH ₃) ₃ ; FW: 103.92; colorless liq.; m.p. -29°; b.p. 68.7°; f.p. 30°F; d. 0.915 <i>moisture sensitive</i>	500g 2kg
05-1320 NEW HAZ	Trimethylborate, 99.95+% (121-43-7) B(OCH ₃) ₃ ; FW: 103.92; colorless liq.; m.p. -29°; b.p. 68.7°; f.p. 30°F; d. 0.915 <i>moisture sensitive</i>	25g 100g
93-0543 HAZ	Triphenylborane, min. 95% (960-71-4) B(C ₆ H ₅) ₃ ; FW: 242.13; off-white powdr.; m.p. 146-148°; b.p. 208°/14 mm <i>air sensitive</i>	1g 5g 25g
05-1295	Triphenylborane, ammonia complex, min. 98% (13276-04-5) (C ₆ H ₅) ₃ B·NH ₃ ; FW: 259.15; white powdr.	1g 5g
05-1400 HAZ	Tri-<i>i</i>-propylborate, min. 98% (5419-55-6) B(OCH(CH ₃) ₂) ₃ ; FW: 188.08; colorless liq.; b.p. 139-141°; f.p. 50°F; d. 0.815 <i>moisture sensitive</i>	100g 500g

Technical Note:

1. Transmetalating agent for the preparation of boronic acids.

References:

1. *Macromolecules*, **1998**, *31*, 2047
2. *J. Org. Chem.*, **1984**, *49*, 5243

05-1500	Tris(pentafluorophenyl)borane, min. 97% (1109-15-5) (C ₆ F ₅) ₃ B; FW: 511.99; off-white powdr. <i>moisture sensitive</i>	1g 5g 25g
05-2000 HAZ	Tris(trimethylsiloxy)borate, min. 97% (4325-85-3) [(CH ₃) ₃ SiO] ₃ B; FW: 278.38; colorless liq.; m.p. -35°; b.p. 184°; f.p. 106°F; d. 0.828 <i>air sensitive</i>	10g 50g
05-5000	Trityltetra(pentafluorophenyl)borate, min. 97% (136040-19-2) (C ₆ H ₅) ₃ C*(C ₆ F ₅) ₄ B; FW: 922.40; yellow powdr. <i>hygroscopic</i>	250mg 1g 5g

BROMINE (Compounds)

93-3501 HAZ 	Bromine (99.5%) (7726-95-6) Br ₂ ; FW: 159.82; dark red liq.; m.p. -7.25°; b.p. 58.8°; d. 3.12 <i>(store cold)</i>	250g 1kg
06-0201	Carbon tetrabromide, vacuum sublimed (99.998%-C) PURATREM (558-13-4) See page 38	
93-3504 HAZ	Hydrobromic acid, 48% (10035-10-6) HBr; FW: 80.92; colorless liq.; m.p. -11°; b.p. 126°; d. 1.490	250g 1kg 5 x 1kg

CADMIUM (Elemental Forms)

93-4851	Cadmium granules (99.999%) (7440-43-9)	25g
HAZ	Cd; FW: 112.41; 1-5 mm; m.p. 320.9°; b.p. 765°; d. 8.642	100g
93-4844	Cadmium pieces (99.9%) (7440-43-9)	100g
HAZ	Cd; FW: 112.41; pieces; m.p. 320.9°; b.p. 765°; d. 8.642	500g
93-4841	Cadmium powder (99.9%) (7440-43-9)	250g
HAZ	Cd; FW: 112.41; -200 mesh; m.p. 320.9°; b.p. 765°; d. 8.642	1kg
93-4848	Cadmium powder (99.999%) (7440-43-9)	10g
HAZ	Cd; FW: 112.41; -200 mesh; m.p. 320.9°; b.p. 765°; d. 8.642	50g
93-4850	Cadmium shot (99.95%) (7440-43-9)	50g
HAZ	Cd; FW: 112.41; tear drop; m.p. 320.9°; b.p. 765°; d. 8.642	250g



CADMIUM (Compounds)

48-0100	Cadmium acetate, anhydrous (99.999%-Cd) PURATREM (543-90-8)	5g
HAZ	Cd(OOCCH ₃) ₂ ; FW: 230.50; white powdr.; m.p. 232-235°	25g
93-4801	Cadmium acetate dihydrate, 98% (5743-04-4)	250g
HAZ	Cd(OOCCH ₃) ₂ ·2H ₂ O; FW: 230.50 (266.54); white powdr.; m.p. 72-73°; d. 2.341	1kg
93-4802	Cadmium acetylacetonate, 98% (14689-45-3)	25g
HAZ	Cd(CH ₃ COCHCOCH ₃) ₂ ; FW: 310.64; white powdr.; m.p. dec.	100g
48-0150	Cadmium arsenide (99.999%-Cd) PURATREM (12006-15-4)	5g
HAZ	Cd ₃ As ₂ ; FW: 487.07; dark gray solid; d. 3.031 <i>moisture sensitive</i>	25g
93-4805	Cadmium bromide, anhydrous, 99% (7789-42-6)	10g
HAZ	CdBr ₂ ; FW: 272.22; white powdr.; m.p. 567°; b.p. 863°; d. 5.192 <i>hygroscopic</i>	50g
93-4806	Cadmium chloride, anhydrous, 99+% (ACS) (10108-64-2)	50g
HAZ	CdCl ₂ ; FW: 183.32; white powdr.; m.p. 568°; b.p. 960°; d. 4.047 <i>hygroscopic</i>	250g
48-1500	Cadmium chloride, anhydrous (99.995%-Cd) PURATREM (10108-64-2)	10g
HAZ	CdCl ₂ ; FW: 183.32; white powdr.; m.p. 568°; b.p. 960°; d. 4.047 <i>hygroscopic</i>	50g
48-0200	Cadmium chloride hydrate (99.998%-Cd) PURATREM (34330-64-8)	5g
HAZ	CdCl ₂ ·XH ₂ O; FW: 183.32; white xtl.	25g
48-1501	Cadmium chloride, (99.999%-Cd) (O₂ < 50ppm) PURATREM (10108-64-2)	5g
amp HAZ	CdCl ₂ ; FW: 183.32; -20 mesh white powdr. (under argon); m.p. 568°; b.p. 960°; d. 4.047 <i>hygroscopic</i>	25g
93-4811	Cadmium fluoride, 99% (7790-79-6)	25g
HAZ	CdF ₂ ; FW: 150.40; white powdr.; m.p. 1100°; b.p. 1758°; d. 6.64	100g
93-4810	Cadmium fluoride (99.98%-Cd) (7790-79-6)	10g
HAZ	CdF ₂ ; FW: 150.40; white powdr.; m.p. 1100°; b.p. 1758°; d. 6.64	50g
93-4812	Cadmium iodide, 99% (7790-80-9)	25g
HAZ	CdI ₂ ; FW: 366.21; white powdr.; m.p. 387°; b.p. 796°; d. 5.670 <i>air sensitive</i>	100g
93-4815	Cadmium nitrate tetrahydrate, 98% (10022-68-1)	100g
HAZ	Cd(NO ₃) ₂ ·4H ₂ O; FW: 236.41 (308.47); colorless, deliquescent xtl.; m.p. 59.4°; d. 2.45	500g
93-4835	Cadmium oxide, 99% (1306-19-0)	250g
HAZ	CdO; FW: 128.40; reddish-brown powdr.; m.p. 1430°; d. 8.15	1kg
93-4817	Cadmium oxide (99.99%-Cd) PURATREM (1306-19-0)	250g
HAZ	CdO; FW: 128.40; reddish-brown powdr.; m.p. 1430°; d. 8.15	1kg
48-0800	Cadmium oxide (99.999%-Cd) PURATREM (1306-19-0)	25g
HAZ	CdO; FW: 128.40; red to brown powdr.; m.p. 1430°; d. 8.15	100g 500g
93-4818	Cadmium perchlorate hexahydrate, 99% (10326-28-0)	25g
HAZ	Cd(ClO ₄) ₂ ·6H ₂ O; FW: 311.30 (419.39); white xtl.	100g
93-4836	Cadmium selenide (99.999%-Cd) PURATREM (1306-24-7)	5g
HAZ	CdSe; FW: 191.36; black powdr.; m.p. > 1350°; d. 5.81	25g

CADMIUM (Compounds)

	Cadmium selenide CANdot® quantum dots (CdSe core), 50umol/L in hexanes (1306-24-7) See page 139	
96-0800	Cadmium selenide CANdot® quantum dot (CdSe core) kit, 50umol/L in hexanes, 525-625nm peak emissions (1306-24-7) See page 533	
	Cadmium selenide/cadmium sulfide CANdot® quantum rods (CdSe/CdS elongated core/shell), 5 mg/ml in hexanes (1306-24-7) See page 139	
96-0813	Cadmium selenide/cadmium sulfide CANdot® quantum rod kit (CdSe/CdS elongated core/shell), 5 mg/ml in hexanes, 560nm, 590nm, 620nm peak emissions (1306-24-7) See page 533	
	Cadmium selenide/Zinc sulfide core/shell quantum dots with Amine in water FWHM <25nm QY>50% See page 140	
	Cadmium selenide/Zinc sulfide core/shell quantum dots with carboxylic acid in water FWHM <25nm QY>50% See page 140	
	Cadmium selenide/Zinc sulfide core/shell quantum dots with PEG in water FWHM <25nm QY>50% See page 140	
	Cadmium selenide/Zinc sulfide quantum dots in solid form See page 139	
93-4821 HAZ	Cadmium sulfate hydrate, 98+% (ACS) (15244-35-6) 3CdSO ₄ ·8H ₂ O; FW: 625.38 (769.51); white powdr.; d. 3.09	50g 250g
93-4823 HAZ	Cadmium sulfide, 98% (1306-23-6) CdS; FW: 144.46; yellow to orange powdr.; m.p. 1750°; d. 4.82	25g 100g 500g
93-4822 HAZ	Cadmium sulfide (99.9+% -Cd) (1306-23-6) CdS; FW: 144.46; yellow to orange powdr.; m.p. 1750°; d. 4.82	25g 100g 500g
93-4840 HAZ	Cadmium sulfide (99.999%-Cd) PURATREM (1306-23-6) CdS; FW: 144.46; yellow to orange powdr.; m.p. 1750°; d. 4.82	10g 50g 250g
	Cadmium sulfide selenide/Zinc sulfide core/shell quantum dots with Amine in water FWHM <35nm QY>50% See page 141	
	Cadmium sulfide selenide/Zinc sulfide core/shell quantum dots with carboxylic acid in water FWHM <35nm QY>50% See page 141	
	Cadmium sulfide selenide/Zinc sulfide core/shell quantum dots with PEG in water FWHM <35nm QY>50% See page 141	
	Cadmium sulfide selenide/Zinc sulfide quantum dots in solid form FWHM <35nm, QY >50% See page 140	
	Cadmium sulfide/Zinc sulfide core/shell quantum dots with Amine in water FWHM <35nm QY>50% See page 142	
	Cadmium sulfide/Zinc sulfide core/shell quantum dots with carboxylic acid in water FWHM <35nm QY>50% See page 143	
	Cadmium sulfide/Zinc sulfide core/shell quantum dots with PEG in water FWHM <35nm QY>50% See page 143	
	Cadmium sulfide/Zinc sulfide quantum dots in solid form FWHM <35nm, QY >50% See page 142	

CADMIUM (Compounds)

48-2000 HAZ	Cadmium telluride (99.999%-Cd) PURATREM (1306-25-8) CdTe; FW: 240.00; -200 mesh black powdr.; m.p. 1041°; d. 6.20	5g 25g
93-4825 HAZ	Cadmium telluride (99.999%-Cd) PURATREM (1306-25-8) CdTe; FW: 240.00; black lumps; m.p. 1041°; d. 6.20	10g 50g
48-5040 HAZ 	Dimethylcadmium, min. 97% (506-82-1) (CH ₃) ₂ Cd; FW: 142.88; colorless liq.; m.p. -4.5°; b.p. 105.5°; f.p. -1°F; d. 1.985 (18°) <i>moisture sensitive, pyrophoric</i> Note: Material may contain a small amount of precipitate.	5g 25g 100g
48-5041 HAZ	Dimethylcadmium, min. 97% (10 wt% in hexanes) (506-82-1) (CH ₃) ₂ Cd; FW: 142.88; colorless liq. <i>air sensitive, moisture sensitive</i>	50g 250g
97-5040 HAZ 	Dimethylcadmium, elec. gr. (99.995+%-Cd) PURATREM (506-82-1) (CH ₃) ₂ Cd; FW: 142.88; colorless liq.; m.p. -4.5°; b.p. 105.5°; f.p. -1°F; d. 1.985 (18°) <i>moisture sensitive, pyrophoric</i> Note: Material may contain a small amount of precipitate.	25g 100g

CALCIUM (Elemental Forms)

20-0074 amp HAZ	Calcium, crystalline, dendritic (99.99%) (7440-70-2) Ca; FW: 40.08; ampouled under argon; m.p. 842°; b.p. 1484°; d. 1.54 <i>air sensitive, moisture sensitive</i>	5g 25g
93-2075 HAZ	Calcium granules (99.5%) (7440-70-2) Ca; FW: 40.08; -6 mesh; m.p. 842°; b.p. 1484°; d. 1.54 <i>air sensitive, moisture sensitive</i>	100g 500g
93-2076 HAZ	Calcium shot (99%) (7440-70-2) Ca; FW: 40.08; 10mm dia.; m.p. 842°; b.p. 1484°; d. 1.54 <i>air sensitive, moisture sensitive</i>	50g 250g
93-2077 HAZ	Calcium turnings (99%) (7440-70-2) Ca; FW: 40.08; turnings; m.p. 842°; b.p. 1484°; d. 1.54 <i>air sensitive, moisture sensitive</i>	50g 250g

CALCIUM (Compounds)

20-8400	Bis(6,6,7,7,8,8,8-heptafluoro-2,2-dimethyl-3, 5-octanedionate)calcium [Ca(FOD)] (36885-29-7) Ca[C ₃ F ₇ COCHCOC(CH ₃) ₂] ₂ ; FW: 630.30; white powdr.; m.p. 208-210°; b.p. dec. 250° (subl. 170°/0.1mm)	1g 5g 25g
20-8450 NEW HAZ	Bis(pentamethylcyclopentadienyl)calcium tetrahydrofuran, 98% (101200-05-9) [(CH ₃) ₅ C ₅] ₂ Ca(C ₄ H ₈ O) ₂ ; FW: 454.74; pale yellow powdr. <i>air sensitive</i>	500mg 2g
20-1000	Bis(2,2,6,6-tetramethyl-3,5-heptanedionato)calcium, min. 97% [Ca(TMHD)] (118448-18-3) Ca(C ₁₁ H ₁₉ O ₂) ₂ ; FW: 406.62; white powdr.; m.p. 220-223°; b.p. dec. 280° (subl. 205°/0.1mm)	1g 5g 25g

Technical Notes:

1. Volatile source of calcium for use in the growth of: calcium carbonate Ref. (1).
2. Volatile source of calcium for use in the growth of: calcium oxide Ref. (2).
3. Volatile source of calcium for use in the growth of: calcium fluoride Ref. (3).

References:

1. *Thin Solid Films*, **2004**, 450, 161
2. *Physica B: Condensed Matter (Amsterdam, Netherlands)* **2009**, 404, 8, 11, 1398
3. *Chem. Mater.* **2007**, 19, 3387

93-2001	Calcium acetate monohydrate, 98% (62-54-4) Ca(OOCCCH ₃) ₂ ·H ₂ O; FW: 158.17 (176.19); white powdr.	250g 1kg
93-2002	Calcium acetylacetonate hydrate (19372-44-2) Ca(CH ₃ COCHCOCH ₃) ₂ ·XH ₂ O; FW: 238.32; white powdr.; m.p. 175° dec.	25g 100g
93-2004 HAZ	Calcium arsenate, min. 95% (7778-44-1) Ca ₃ (AsO ₄) ₂ ; FW: 398.08; white powdr.; d. 3.620	25g 100g 500g

CALCIUM (Compounds)

20-1500	Calcium bromide, anhydrous (99.5%-Ca) (7789-41-5) CaBr ₂ ; FW: 199.90; -80 mesh white powdr.; b.p. 806-812°; d. 3.353 <i>hygroscopic</i>	50g 250g
93-2007	Calcium bromide hydrate, 98% (71626-99-8) CaBr ₂ ·XH ₂ O; FW: 199.90; white powdr.	100g 500g
93-2010	Calcium carbonate, 98% (471-34-1) CaCO ₃ ; FW: 100.09; white powdr.; d. 2.930	250g 1kg
93-2011	Calcium carbonate (99.95%-Ca) (471-34-1) CaCO ₃ ; FW: 100.09; -325 mesh white powdr.; d. 2.930	100g 500g
20-0200	Calcium carbonate (99.999%-Ca) PURATREM (471-34-1) CaCO ₃ ; FW: 100.09; white powdr.; d. 2.930	10g 50g
20-2060	Calcium chloride hydrate (99.999%-Ca) PURATREM (22691-02-7) CaCl ₂ ·XH ₂ O; FW: 110.99; white powdr.	5g 25g 100g
93-2012 HAZ	Calcium chromate, min. 95% (13765-19-0) CaCrO ₄ ; FW: 156.06; yellow xtl.	100g 500g
93-2014	Calcium 2-ethylhexanoate, superconductor grade, 40% in 2-ethylhexanoic acid (3-8% Ca) (136-51-6) Ca[OOCCH(C ₂ H ₅)C ₄ H ₉] ₂ ; FW: 326.50; viscous liq.	25g 100g
93-2017	Calcium fluoride (99.9%-Ca) (7789-75-5) CaF ₂ ; FW: 78.08; <5 micron white powdr.; m.p. 1360°; b.p. ~2500°; d. 3.180	250g 1kg
20-2500	Calcium hexafluoroacetylacetonate dihydrate, 97% (203863-17-6) Ca(CF ₃ COCHCOCF ₃) ₂ ·2H ₂ O; FW: 454.18 (486.18); off-white powdr.; m.p. 135-140°; b.p. dec. 230-240° (subl. 180°/0.07mm)	1g 5g 25g
93-2021 HAZ	Calcium hydride, 95% (7789-78-8) CaH ₂ ; FW: 42.10; 1-20mm light gray granules; m.p. 816° (H ₂); d. 1.9 <i>moisture sensitive</i>	50g 250g
20-2021 HAZ	Calcium hydride, min. 97% (7789-78-8) CaH ₂ ; FW: 42.10; 0-2mm white to gray powdr.; m.p. 816° (H ₂); d. 1.9 <i>moisture sensitive</i>	50g 250g
93-2023 HAZ	Calcium iodate, 98% (7789-80-2) Ca(IO ₃) ₂ ; FW: 389.89; white powdr.; m.p. 540° dec.; d. 4.519	50g 250g
93-2024	Calcium iodide, anhydrous, 98+% (10102-68-8) CaI ₂ ; FW: 293.89; -20 mesh off-white powdr. <i>hygroscopic</i>	25g 100g
93-2025	Calcium iodide hydrate, min. 98% (71626-98-7) CaI ₂ ·XH ₂ O; FW: 293.89; white lumps <i>moisture sensitive</i>	50g 250g
93-2062 HAZ	Calcium methoxide, min. 90% (balance methanol) (2556-53-8) Ca(OCH ₃) ₂ ; FW: 102.15; off-white powdr. <i>moisture sensitive</i>	25g 100g
93-2026	Calcium molybdate (99.9%-Ca) (7789-82-4) CaMoO ₄ ; FW: 200.01; white powdr.; m.p. 965°; d. 4.38-4.53	25g 100g
93-2027 HAZ	Calcium naphthenate, ~35% in mineral spirits (4% Ca) (61789-36-4) viscous liq.	500g 2kg
20-7000	Calcium neodecanoate, superconductor grade (9-11% Ca) (27253-33-4) Ca(OOCC ₉ H ₁₉ -neo) ₂ ; FW: 382.56; waxy solid	10g 50g
93-2028 HAZ	Calcium nitrate tetrahydrate, 99% (13477-34-4) Ca(NO ₃) ₂ ·4H ₂ O; FW: 164.09 (236.16); white xtl.; m.p. 39.7°; b.p. 132° dec.; d. 1.82	250g 1kg
20-2025	Calcium nitride (99%-Ca) (12013-82-0) Ca ₃ N ₂ ; FW: 148.25; -200 mesh black powdr. <i>air sensitive, moisture sensitive</i>	5g 25g
93-2031 HAZ	Calcium oxide, 98% (1305-78-8) CaO; FW: 56.08; white powdr.; m.p. 2580°; b.p. 2850°; d. 3.30 <i>moisture sensitive</i>	250g 1kg
20-2030 HAZ	Calcium oxide (99.95%-Ca) (1305-78-8) CaO; FW: 56.08; -325 mesh white powdr.; m.p. 2580°; b.p. 2850°; d. 3.30 <i>moisture sensitive</i>	10g 50g

CALCIUM (Compounds)

93-2033 HAZ	Calcium perchlorate hydrate, 99% (13477-36-6) Ca(ClO ₄) ₂ ·XH ₂ O; FW: 238.98; white xtl.	100g 500g
20-2035	Calcium phosphate, dibasic (99.95%-Ca) (7757-93-9) CaHPO ₄ ; FW: 136.06; 6-8 micron white powdr.	50g 250g
20-2037	Calcium phosphate, monobasic, monohydrate, 99% (10031-30-8) Ca(H ₂ PO ₄) ₂ ·H ₂ O; FW: 234.06 (252.07); white powdr.	250g 1kg
20-2039	Calcium phosphate, tribasic (~37% Ca) (7758-87-4) Ca ₁₀ (OH) ₂ (PO ₄) ₆ ; FW: 1004.62; white powdr.	250g 1kg 5kg
93-2072 HAZ	Calcium phosphide, 97% (1305-99-3) Ca ₃ P ₂ ; FW: 182.19; 1/2" pieces and down; m.p. ~1600°; d. 2.51 <i>moisture sensitive</i>	25g 100g
93-2073	Calcium pyrophosphate (99.95%-Ca) (7790-76-3) Ca ₂ P ₂ O ₇ ; FW: 254.10; 6-8 micron white powdr.; m.p. 1230°; d. 3.09	25g 100g
93-2043 HAZ	Calcium silicide, 90% (~4% Fe, ~6% Ba+Al) (12013-56-8) CaSi ₂ ; FW: 96.25; -325 mesh powdr. <i>moisture sensitive</i>	100g 500g 2kg
93-2045	Calcium stearate, min. 85% (1592-23-0) Ca(O ₂ C ₁₈ H ₃₅) ₂ ; FW: 607.04; white powdr.	100g 1kg
93-2074	Calcium sulfate dihydrate, 98+% (ACS) (10101-41-4) CaSO ₄ ·2H ₂ O; FW: 136.14 (172.17); white powdr.; d. 2.32	500g 2kg
93-2047 HAZ	Calcium sulfide (99.9+%Ca) (20548-54-3) CaS; FW: 72.14; off-white powdr.; d. 2.5 <i>moisture sensitive</i>	10g 50g
20-2050	Calcium titanate, 99% (12049-50-2) CaTiO ₃ ; FW: 135.98; off-white powdr.; m.p. 1975°; d. 4.10	500g 2kg
20-5000	Calcium trifluoromethanesulfonate, min. 96% (Calcium triflate) (55120-75-7) Ca(CF ₃ SO ₃) ₂ ; FW: 338.21; white powdr.; m.p. dec. <i>hygroscopic</i>	10g 50g
20-5025	Calcium trifluoromethanesulfonimide, min. 97% (165324-09-4) Ca(C ₂ F ₆ NO ₄ S ₂) ₂ ; FW: 600.37; white solid <i>hygroscopic</i>	250mg 1g 5g
20-2052	Calcium tungstate, 98% (7790-75-2) CaWO ₄ ; FW: 287.93; white powdr.; m.p. 1620°; d. 6.062	100g 500g

CARBON (Elemental Forms)

06-0025	Acetylene carbon black (100% compressed) (1333-86-4) C; FW: 12.011; black powdr. (avg. particle size 0.042 microns); SA: 80m ² /g; m.p. 3652-3697° (subl.); b.p. 4200°; d. bulk 0.21g/cm ³	250g 1kg
06-0026	Acetylene carbon black (50% compressed) (1333-86-4) C; FW: 12.011; black powdr. (avg. particle size 0.042 microns); SA: 80m ² /g; m.p. 3652-3697° (subl.); b.p. 4200°; d. bulk 0.10/g/cm ³	250g 1kg
06-0100	Activated carbon (7440-44-0) C; FW: 12.011; black powdr.; SA: 1300-1400 m ² /g; m.p. 3652-3697° (subl.); b.p. 4200°; d. 1.8-2.1 (amorphous)	300g 1kg
06-0050	Activated carbon (7440-44-0) C; FW: 12.011; 4 x 10 mesh black gran.; SA: 1000 m ² /g; m.p. 3652-3697° (subl.); b.p. 4200°; d. 1.8-2.1 (amorphous)	500g 2kg
	Carbon nanotubes (308068-56-6) See page 148	
93-0601	Carbon powder (99+%) (7440-44-0) C; FW: 12.011; -325 mesh powdr.; m.p. 3652-3697° (subl.); b.p. 4200°; d. 1.8-2.1 (amorphous)	250g 1kg
93-0602	Carbon powder (99.999%) (7440-44-0) C; FW: 12.011; -200 mesh powdr.; m.p. 3652-3697° (subl.); b.p. 4200°; d. 1.8-2.1 (amorphous)	5g 25g
93-0605	Carbon rods (99.999%) (7440-44-0) C; FW: 12.011; 3mm dia. x 30cm; m.p. 3652-3697° (subl.); b.p. 4200°; d. 1.8-2.1 (amorphous)	1rod 5rods

CARBON (Elemental Forms)

93-0608	Carbon sheet (99.8%) (7440-44-0) C; FW: 12.011; 0.25 mm thick x 15 cm wide; m.p. 3652-3697° (subl.); b.p. 4200°; d. 1.8-2.1 (amorphous)	30 x 15cm 150 x 15cm
93-0607	Carbon sheet (99.8%) (7440-44-0) C; FW: 12.011; 0.127 mm thick x 15 cm wide; m.p. 3652-3697° (subl.); b.p. 4200°; d. 1.8-2.1 (amorphous)	30 x 15cm 150 x 15cm
93-0609	Carbon yarn (99.9%) (7440-44-0) C; FW: 12.011; ~0.6mm dia.; m.p. 3652-3697° (subl.); b.p. 4200°; d. 1.8-2.1 (amor- phous)	5m 25m
06-0502	Fullerene - C₆₀, min. 99.9% (Buckminsterfullerene) (99685-96-8) C ₆₀ ; FW: 720.66; black powdr.	25mg 100mg 500mg
06-0602	Fullerene - C₆₀, 99.9+% (Buckminsterfullerene) (99685-96-8) C ₆₀ ; FW: 720.66; black powdr.	25mg 100mg 500mg
06-0500	Fullerenes - C₆₀/C₇₀ mixture (contains ~20% C₇₀ and ~1% higher fullerenes) (131159-39-2) C ₆₀ , C ₇₀ ; FW: 720.66, 840.77; black powdr.; d. 1.6	50mg 250mg 1g
06-0503	Fullerene - C₇₀, min. 98% (115383-22-7) C ₇₀ ; FW: 840.77; black powdr.	10mg 50mg 250mg
06-0603	Fullerene - C₇₀, min. 99% (115383-22-7) C ₇₀ ; FW: 840.77; black powdr.	10mg 50mg 250mg
06-0525	Fullerene - C₇₆, min. 95% (135113-15-4) C ₇₆ ; FW: 912.84; black powdr.	5mg
06-0526	Fullerene - C₇₆, min. 98% (135113-15-4) C ₇₆ ; FW: 912.84; black powdr.	5mg
06-0527	Fullerene - C₇₆, 99.9% (135113-15-4) C ₇₆ ; FW: 912.84; black powdr.	5mg
06-0530	Fullerene - C₇₈, min. 95% (136316-32-0) C ₇₈ ; FW: 936.86; black powdr.	5mg
06-0507	Fullerene - C₈₄, min. 95% (135113-16-5) C ₈₄ ; FW: 1008.93; black powdr.	5mg
06-0607	Fullerene - C₈₄, min. 99% (135113-16-5) C ₈₄ ; FW: 1008.92; black powdr.	5mg
06-0512	Fullerene carbon soot (contains 5-8wt% C₆₀/C₇₀ and higher fullerenes) (131159-39-2) C ₆₀ /C ₇₀ ; black powdr.	5g 25g
06-0274	Graphene film, monolayer, on copper foil (1cm x 1cm) (1034343-98-0) See page 143	
	Graphene film, monolayer, on Si/SiO₂ wafer (1cm x1cm), by CVD (1034343-98-0) See page 143	
	Graphene nanoplatelets (1034343-98-0) See page 146	
	Graphene nanoplatelets aggregates (1034343-98-0) See page 146	
06-0323	Graphene oxide (0.8-1.2nm thick x 1-15 microns wide, made by the Staudenmaier Method) See page 143	
06-2545	Graphene oxide (4mg/ml water dispersion) (1034343-98-0) See page 144	
06-2550	Graphene oxide, reduced (1034343-98-0) See page 144	
06-0318	Graphene powder (1-5 layers thick x 0.5-5 microns wide, surface area 650-750 m²/g) (1034343-98-0) See page 144	



CARBON (Elemental Forms)

06-0313	Graphene powder (single layer, surface area 400-1000 m²/g) (1034343-98-0) See page 144	
	Graphene Quantum Dots (GQDs) (1034343-98-0) See page 147	
06-2510	Monolayer Graphene on Cu (10 mm x 10 mm) (1034343-98-0) See page 144	
06-2518	Monolayer Graphene on Cu (60 mm x 40 mm) (1034343-98-0) See page 145	
06-2523	Monolayer Graphene on Cu with PMMA coating (60mm x 40mm) (1034343-98-0) See page 145	
06-2534	Monolayer Graphene on SiO₂/Si (10mm x 10mm) (1034343-98-0) See page 145	

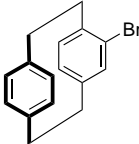
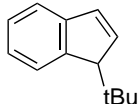
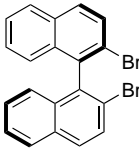
CARBON (Compounds)

06-0114	2-Bromo-1,1'-binaphthyl, 98% (207611-58-3) C ₂₀ H ₁₃ Br; FW: 333.22; white powdr.	500mg 2g
06-0104	racemic-4-Bromo[2.2]paracyclophane, min. 95% (1908-61-8) C ₁₆ H ₁₅ Br; FW: 287.19; white powdr. Note: Paracyclophane Kit component.	500mg 2g
		
06-0135	1-t-Butyl-1H-indene, min. 95% (40650-31-5) C ₁₃ H ₁₆ ; FW: 172.27; colorless liq.	250mg 1g
		
06-0115	n-Butylisocyanide, 97% (2769-64-4) HAZ C ₄ H ₉ N≡C; FW: 83.13; colorless to pale yellow liq.; d. 0.795 (store cold), STENCH	1g 5g
06-0120	t-Butylisocyanide, min. 98% (7188-38-7) amp HAZ (CH ₃) ₃ CN≡C; FW: 83.13; colorless liq.; b.p. 90-92°; f.p. 28°F; d. 0.735 (store cold), STENCH	1g 5g
06-0150	t-Butylmethylacetylene, min. 98% (999-78-0) HAZ C ₄ H ₈ C≡C(CH ₃); FW: 96.17; colorless liq.; b.p. 83°; f.p. 14°F; d. 0.718	1g 5g
06-0201	Carbon tetrabromide, vacuum sublimed (99.998%-C) PURATREM (558-73-4) amp HAZ CBr ₄ ; FW: 331.65; white xtl.; m.p. 88-90°; b.p. 190°	25g 100g
06-0350	Cyclooctatetraene, 98% COT (629-20-9) HAZ C ₈ H ₈ ; FW: 104.15; pale yellow liq.; m.p. -5°; b.p. 142-143°; f.p. 73°F; d. 0.943 air sensitive, (store cold) Note: Inhibited with 0.1% hydroquinone.	1g 5g
06-5000	neo-Decanoic acid, prime grade (26896-20-8) isomeric C ₁₀ acids; colorless liq.; b.p. 243-253°; d. 0.92	100g 500g
06-0483	(1R)-2,2'-Dibromo-1,1'-binaphthalene, min. 98% (86688-08-6) C ₂₀ H ₁₂ Br ₂ ; FW: 412.12; white to light-yellow solid Note: Sold in collaboration with Daicel for research purposes only.	50mg 100mg
		
06-0484	(1S)-2,2'-Dibromo-1,1'-binaphthalene, min. 98% (150024-49-0) C ₂₀ H ₁₂ Br ₂ ; FW: 412.12; white to light-yellow powdr. Note: Sold in collaboration with Daicel for research purposes only.	50mg 100mg
06-0450	racemic-2,2'-Dibromo-1,1'-binaphthyl, min. 96% (74866-28-7) C ₂₀ H ₁₂ Br ₂ ; FW: 412.13; white to off-white powdr.; m.p. 178-181°	1g 5g

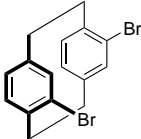
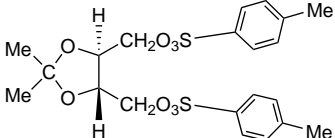
CARBON (Compounds)

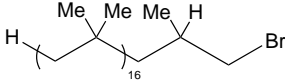
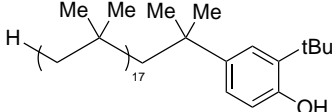
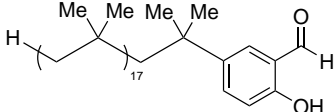
06-0477	2,2'-Dibromobiphenyl, 98+% (13029-09-9) C ₁₂ H ₈ Br ₂ ; FW: 312.00; white powdr.		1g 5g
06-0460	racemic-4,12-Dibromo[2.2]paracyclophane, min. 95% (23927-40-4) C ₁₆ H ₁₄ Br ₂ ; FW: 366.09; white to off-white powdr. Note: Paracyclophane Kit component.		250mg 1g
06-0550	Diphenylacetylene, 99% (501-65-5) C ₆ H ₅ C≡CC ₆ H ₅ ; FW: 178.23; white powdr.; m.p. 59-61°; b.p. 170°/19 mm; d. 0.990		2g 10g
06-1050	(4R,5R)-(-)-O-Isopropylidene-2,3-dihydroxy-1,4-bis (p-tosyl)butane (51064-65-4) C ₂₁ H ₂₆ O ₆ S ₂ ; FW: 470.56; white powdr.; m.p. 89-91° (store cold)		1g 5g
06-1040	(4S,5S)-(+)-O-Isopropylidene-2,3-dihydroxy-1,4-bis (p-tosyl)butane (37002-45-2) C ₂₁ H ₂₆ O ₆ S ₂ ; FW: 470.56; white powdr.; m.p. 89-91° (store cold)		1g 5g
03-1150	Lithium pentamethylcyclopentadienide, min. 98% (51905-34-1) See page 118		
03-4750	Lithium tetramethylcyclopentadienide, min. 95% (82061-21-0) See page 118		
06-1037 amp HAZ	2-Methyl-3-[polyisobutyl(12)]propanol (50% in heptane/polyisobutylene) C ₅₂ H ₁₀₆ O; FW: 747; colorless liq.		1g 5g
06-1045 amp HAZ	2-Methyl-3-[polyisobutyl(12)]propyl bromide (50% in heptane/polyisobutylene) C ₆₈ H ₁₃₇ Br; FW: 1035; pale yellow liq.		1g 5g
96-7052	Paracyclophane Kit See page 544		
06-1290 amp HAZ	Pentamethylcyclopentadiene, min. 98% (4045-44-7) C ₁₀ H ₁₆ ; FW: 136.24; pale yellow liq.; b.p. 58.3°/13.5 mm; f.p. 112°F; d. 0.870 (store cold)		1g 5g 25g
06-1296	1,2,3,4,5-Pentaphenyl-1,3-cyclopentadiene, 99% (2519-10-0) C ₃₅ H ₂₆ ; FW: 446.60; white powdr.; m.p. 254-256°		1g 5g
06-1150 HAZ	neo-Pentylchloride, 98% (753-89-9) (CH ₃) ₃ CCH ₂ Cl; FW: 106.59; colorless liq.; m.p. -20°; b.p. 84-85°; f.p. 16°F; d. 0.866		5g 25g 100g
06-1060	Polydiacetylene nanotube (PDNT-12-8-22Br) See page 149		
06-5075	Polyethylene glycol dodecyl ether (Brij™ 35) (9002-92-0) See page 168		
06-1055 amp HAZ	4-[Polyisobutyl(18)]-2-(t-butyl)phenol (50% in heptane/polyisobutylene) C ₈₂ H ₁₅₈ O; FW: 1160; yellow liq.		1g 5g
06-1032 amp HAZ	5-[Polyisobutyl(18)]-2-hydroxybenzaldehyde (50% in heptane/polyisobutylene) C ₇₉ H ₁₅₀ O ₂ ; FW: 1132; yellow liq.		1g 5g

CARBON (Compounds)

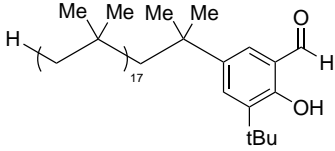
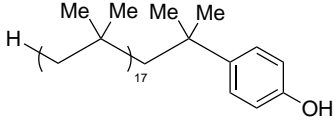
06-1035 amp HAZ	5-[Polyisobutyl(18)]-2-hydroxy-3-(<i>t</i> -butyl) benzaldehyde (50% in heptane/polyisobutylene) $C_{83}H_{158}O_2$; FW: 1188.00; yellow liq.		1g 5g
06-1048 amp HAZ	4-[Polyisobutyl(18)]phenol (50% in heptane/polyisobutylene) $C_{78}H_{150}O$; FW: 1104; pale yellow liq.		1g 5g
08-2040	(S)-(+)-1,2-Propanediol, 99% (4254-15-3) See page 220		
06-1850 amp HAZ	<i>i</i> -Propylisocyanide, min. 97% (598-45-8) $i-C_3H_7N\equiv C$; FW: 69.11; colorless liq.; b.p. 82-83°; d. 0.7596 (store cold), STENCH		1g 5g
06-2000	Styrene-divinylbenzene copolymer (20% cross-linked) (9003-53-6) white beads, 20-60 mesh		50g 250g
06-3050 amp HAZ	Tetramethyl(<i>n</i> -propyl)cyclopentadiene, min. 97% (64417-12-5) $C_{12}H_{20}$; FW: 164.30; yellow liq.		1g 5g 25g

CERIUM (Elemental Forms)

58-0040 HAZ	Cerium chips (99.9% REO) (7440-45-1) Ce; FW: 140.13; (packed in mineral oil); m.p. 815°; b.p. 3257°; d. 6.90 <i>air sensitive, moisture sensitive</i>		25g 100g
58-0050 HAZ	Cerium foil (99.9% REO) (7440-45-1) Ce; FW: 140.13; 1.0mm thick (-4.2g/25 x 25mm) (packed in mineral oil); m.p. 815°; b.p. 3257°; d. 6.90 <i>air sensitive, moisture sensitive</i>		25 x 25mm 50 x 50mm
93-5866 HAZ	Cerium ingot (99.9% REO) (7440-45-1) Ce; FW: 140.13; (packed in mineral oil); m.p. 815°; b.p. 3257°; d. 6.90 <i>air sensitive, moisture sensitive</i> For detailed technical note visit strem.com .		25g 100g

CERIUM (Compounds)

93-5803	Ammonium cerium(IV) nitrate, 98.5+% (ACS) (16774-21-3) See page 5		
93-5801	Cerium(III) acetate hydrate (99.9%-Ce) (REO) (537-00-8) $Ce(OOCCH_3)_3 \cdot XH_2O$; FW: 317.26; white powdr.		50g 250g
58-5801	Cerium(III) acetate hydrate (99.999%-Ce) (REO) PURATREM (537-00-8) $Ce(OOCCH_3)_3 \cdot XH_2O$; FW: 317.26; white powdr.		25g 100g
93-5802	Cerium(III) acetylacetonate hydrate (99.9%-Ce) (REO) (15653-01-7) $Ce(CH_3COCHCOCH_3)_3 \cdot XH_2O$; FW: 437.44; tan powdr.		25g 100g
93-5861	Cerium(III) bromide, anhydrous (99.9%-Ce) (REO) (14457-87-5) $CeBr_3$; FW: 379.85; orange powdr. <i>hygroscopic</i>		5g 25g
93-5806	Cerium(III) bromide hydrate (99.9%-Ce) (REO) (396654-07-2) $CeBr_3 \cdot XH_2O$; FW: 379.85; white xtl.		10g 50g
93-5800	Cerium(III) carbonate hydrate (96%-Ce) (REO) (54451-25-1) $Ce_2(CO_3)_3 \cdot XH_2O$; FW: 460.29; off-white powdr.		250g 1kg 5kg
93-5807	Cerium(III) carbonate hydrate (99+%-Ce) (REO) (54451-25-1) $Ce_2(CO_3)_3 \cdot XH_2O$; FW: 460.29; white xtl.		50g 250g
93-5862	Cerium(III) chloride, anhydrous ($H_2O < 0.5\%$) (99.9%-Ce) (REO) (7790-86-5) $CeCl_3$; FW: 246.48; white powdr.; m.p. 848°; b.p. 1727°; d. 3.92 <i>hygroscopic</i>		5g 25g 100g

CERIUM (Compounds)

93-5808	Cerium(III) chloride hydrate (99.9%-Ce) (REO) (19423-76-8) CeCl ₃ ·XH ₂ O; FW: 246.48; white to pale yellow xtl.	100g 500g
58-0200	Cerium(III) chloride hydrate (99.99%-Ce) (REO) PURATREM (19423-76-8) CeCl ₃ ·XH ₂ O; FW: 246.48; white to pale yellow xtl.	25g 100g
58-5100	Cerium(IV) ethyl/butyl phosphonate Silica (PhosphonicS POce) yellow solid; SA: >350 m ² /g Note: Sold in collaboration with PhosphonicS Ltd. for research purposes only. PhosphonicS Metal Oxidation Catalyst Kit component.	5g 25g

Technical Note:
1. Catalyst used for the oxidation of a range of sulfides to sulfoxides.

Particle size range: 70-200 microns
Average pore size: 60Å
Effective loadings: 0.3 to 0.5 mmol/g

References:
1. *Tetrahedron Lett.*, **2005**, *46*, 4365

93-5833	Cerium(III) 2-ethylhexanoate, 49% in 2-ethylhexanoic acid (12% Ce) (56797-01-4) Ce[OOCCH(C ₂ H ₅)C ₄ H ₉] ₃ ; FW: 569.74; viscous liq.; f.p. 230°F; d. 1.08	500g 2kg
93-5825	Cerium(III) fluoride (99.9%-Ce) (REO) (7758-88-5) CeF ₃ ; FW: 197.12; white to off-white powdr.; m.p. 1460°; b.p. ~2300°; d. 6.16 <i>hygroscopic</i>	25g 100g
58-0500	Cerium(IV) fluoride, anhydrous, 99% (10060-10-3) CeF ₄ ; FW: 216.13; white powdr.; m.p. 650° dec. <i>hygroscopic</i>	10g 50g
58-0505	Cerium(IV) fluoride, hydrate (60627-09-0) CeF ₄ ·XH ₂ O; FW: 216.13; white powdr.; m.p. -H ₂ O @ 100°, 650° dec.	10g 50g
93-5810	Cerium(IV) hydroxide, min. 85% (12014-56-1) Ce(OH) ₄ ; FW: 208.15; white to yellow powdr.	25g 100g
93-5812	Cerium(III) iodide hydrate (7790-87-6) CeI ₃ ·XH ₂ O; FW: 520.82; yellow xtl.	5g 25g
58-0870	Mixed metal oxides of cerium(IV) [contains some Ce(III)] and iron(III) in octanoic acid and Kenzol 50H (CEF-KE02) See page 149	
58-0865	Mixed metal oxides of cerium(IV) [contains some Ce(III)] and iron(III) in water at pH 4.75 +/-0.25 (CEF-W420) See page 149	
93-5831	Cerium(III) nitrate hexahydrate (99.9%-Ce) (REO) (10294-41-4) HAZ Ce(NO ₃) ₃ ·6H ₂ O; FW: 326.17 (434.23); white xtl.	100g 500g
93-5814	Cerium(III) nitrate hexahydrate (99.99%-Ce) (REO) PURATREM (10294-41-4) HAZ Ce(NO ₃) ₃ ·6H ₂ O; FW: 326.17 (434.23); white xtl.	10g 50g
58-5845	Cerium nitride (99.9%-Ce) (25764-08-3) CeN; FW: 154.12; -60 mesh powdr.	250mg 1g
93-5832	Cerium(III) oxalate nonahydrate (99.9%-Ce) (REO) (13266-83-6) Ce ₂ (C ₂ O ₄) ₃ ·9H ₂ O; FW: 544.30 (706.44); white xtl.; m.p. dec.	25g 100g
93-5816	Cerium(IV) oxide (99.9%-Ce) (REO) (1306-38-3) CeO ₂ ; FW: 172.12; yellow powdr.; m.p. ~2600°; d. 7.132	50g 250g 1kg
58-0800	Cerium(IV) oxide (99.995%-Ce) PURATREM (1306-38-3) CeO ₂ ; FW: 172.12; yellow powdr.; m.p. ~2600°; d. 7.132	5g 25g

CERIUM (Compounds)

58-0850	Cerium(IV) oxide [contains some Ce(III)] in water at pH = 9.0 +0.5 (CEO-W290) (1306-38-3) See page 149	
58-0860	Cerium(IV) oxide [contains some Ce(III)] in water at pH = 3.5 +0.75 (CEO-W320) (1306-38-3) See page 150	
58-1400	Cerium(IV) oxide nanopowder (1306-38-3) See page 150	
93-5860	Cerium(III) perchlorate hexahydrate, reagent (14017-47-1) HAZ Ce(ClO ₄) ₃ ·6H ₂ O; FW: 438.47 (546.56); white xtl.	50g 250g
93-5818	Cerium(III) phosphate (99.9%-Ce) (REO) (721880-19-9) CePO ₄ ; FW: 235.09; off-white pwdr.	25g 100g
58-1000	Cerium(III) stearate, tech. gr. (10119-53-6) Ce(O ₂ C ₁₈ H ₃₅) ₃ ; FW: 990.49; white pwdr.; m.p. 120-124°	500g 2500g
93-5835	Cerium(III) sulfate octahydrate (99%-Ce) (REO) (10450-59-6) Ce ₂ (SO ₄) ₃ ·8H ₂ O; FW: 568.42 (712.42); white xtl.	25g 100g
93-5836	Cerium(III) trifluoroacetylacetonate hydrate (63356-25-2) Ce(CF ₃ COCHCOCH ₃) ₃ ·XH ₂ O; FW: 599.36; yellow xtl.	5g 25g
58-6000	Cerium(III) trifluoromethanesulfonate, min. 98% (Cerium triflate) (76089-77-5) Ce(CF ₃ SO ₃) ₃ ; FW: 587.33; white pwdr. <i>hygroscopic</i>	5g 25g
93-7401	Cerium(III) tungstate (99.9%-Ce) (REO) (13454-74-5) Ce ₂ (WO ₄) ₃ ; FW: 1023.79; off-white pwdr.	5g 25g
96-6770	PhosphonicS Metal Oxidation Catalyst Kit See page 488	
58-5000	Tetrakis(2,2,6,6-tetramethyl-3,5-heptanedionato)cerium(IV), min. 97% (99.9%-Ce) (REO) [Ce(TMHD)₄] (18960-54-8) Ce(C ₁₁ H ₁₉ O ₂) ₄ ; FW: 873.20; red pwdr.; m.p. 275-280°; b.p. dec. 295° (subl. 140°/0.05mm)	1g 5g 25g
58-7500 amp	Tris(cyclopentadienyl)cerium(III) (99.9%-Ce) (REO) (1298-53-9) (C ₅ H ₅) ₃ Ce; FW: 335.41; yellow pwdr.; m.p. 452° dec.; b.p. subl. 230°/0.01 mm <i>air sensitive, moisture sensitive</i>	1g 5g
58-7750	Tris(6,6,7,7,8,8,8-heptafluoro-2,2-dimethyl-3,5-octanedionate)cerium(III), 99% [Ce(FOD)₃] (172424-98-5) Ce(C ₃ F ₇ COCHCOC ₂ H ₉) ₃ ; FW: 1025.64; yellow pwdr.	250mg 1g
58-8000 amp	Tris(i-propylcyclopentadienyl)cerium(III) (99.9%-Ce) (REO) (122528-16-9) [(C ₃ H ₇)C ₅ H ₄] ₃ Ce; FW: 461.64; violet-blue xtl. <i>air sensitive</i>	1g 5g
58-9000	Tris(1,2,3,4-tetramethyl-2,4-cyclopentadienyl)cerium(III) (99.9%-Ce) (REO) (251984-08-4) [(CH ₃) ₄ C ₅ H ₃] ₃ Ce; FW: 503.73; green pwdr. <i>air sensitive</i>	1g 5g

CESIUM (Elemental Forms)

93-5550 amp HAZ	Cesium (99.5%) (prescored ampoule) (7440-46-2) Cs; FW: 132.91; under argon; m.p. 28.64°; b.p. 690°; d. 1.892 <i>moisture sensitive, pyrophoric</i>	1g 5g
55-5551 amp HAZ	Cesium (99.9+%) (prescored ampoule) (7440-46-2) Cs; FW: 132.91; under argon; m.p. 28.64°; b.p. 690°; d. 1.892 <i>moisture sensitive, pyrophoric</i>	1g 5g 25g

CESIUM (Compounds)

93-5510	Cesium acetate (99.9%-Cs) (3396-11-0) CsOOCCH ₃ ; FW: 191.95; lump; m.p. 194° <i>hygroscopic</i>	10g 50g
93-5513	Cesium bromide (99%-Cs) (7787-69-1) CsBr; FW: 212.81; white xtl.; m.p. 636°; b.p. 1300°; d. 4.44 <i>hygroscopic</i>	25g 100g

CESIUM (Compounds)

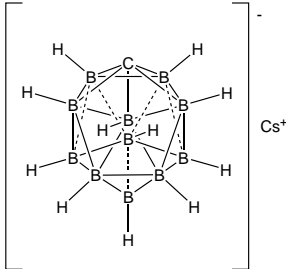
93-5541	Cesium bromide (99.9%-Cs) (7787-69-1) CsBr; FW: 212.81; white xtl.; m.p. 636°; b.p. 1300°; d. 4.44 <i>hygroscopic</i>	10g 50g
93-5514	Cesium carbonate (99+%-Cs) (534-17-8) Cs ₂ CO ₃ ; FW: 325.82; white powdr.; m.p. 610° dec. <i>hygroscopic</i>	25g 100g 500g
55-5525	Cesium carborane (12539-26-3) Cs ⁺ CB ₁₀ H ₁₂ ⁻ ; FW: 275.93; white powdr.	250mg 1g
		
Technical Note:		
1. A class of "super weak" coordinating anions. These materials are useful as counterions to cationic catalysts and strong one-electron oxidants.		
References:		
1. <i>Acc. Chem. Res.</i> , 1998 , <i>31</i> , 133		
93-5536	Cesium chloride (99+%-Cs) (7647-17-8) CsCl; FW: 168.36; white xtl.; m.p. 646°; b.p. 1290°; d. 3.988 <i>hygroscopic</i>	25g 100g
93-5535	Cesium chloride (99.9%-Cs) (7647-17-8) CsCl; FW: 168.36; white xtl.; m.p. 646°; b.p. 1290°; d. 3.988 <i>hygroscopic</i>	10g 50g
93-5542	Cesium chloride (99.999%-Cs) PURATREM (7647-17-8) CsCl; FW: 168.36; white xtl.; m.p. 646°; b.p. 1290°; d. 3.988 <i>hygroscopic</i>	10g 50g
55-1800 HAZ	Cesium dodecahydrododecaborate, min. 98% (12008-75-2) Cs ₂ B ₁₂ H ₁₂ ⁻ ; FW: 407.64; white powdr. <i>hygroscopic</i>	5g 25g 100g
55-2000 HAZ	Cesium 2-ethylhexoxide (0.8-1.0M in octane/toluene) CH ₃ CH ₂ CH ₂ CH ₂ CH(C ₂ H ₅)CH ₂ OCs; FW: 262.12; light-yellow liq.; f.p. 60°F (octane) <i>moisture sensitive</i>	5g 25g
93-5519 HAZ	Cesium fluoride (99+%-Cs) (13400-13-0) CsF; FW: 151.90; white powdr.; m.p. 682°; b.p. 1251°; d. 4.115 <i>hygroscopic</i>	25g 100g
93-5518 HAZ	Cesium fluoride (99.9%-Cs) (13400-13-0) CsF; FW: 151.90; white powdr.; m.p. 682°; b.p. 1251°; d. 4.115 <i>hygroscopic</i>	10g 50g
93-5520 HAZ	Cesium hydroxide, 50% aqueous solution (99.9%-Cs) (21351-79-1) CsOH; FW: 149.91; colorless liq. <i>hygroscopic</i>	25g 100g
93-5521 HAZ	Cesium hydroxide, hydrate (99.9%-Cs) (12260-45-6) CsOH·XH ₂ O; FW: 149.91; xtl. (15-20% H ₂ O); m.p. 272°; d. 3.675 <i>hygroscopic</i>	10g 50g
93-5524	Cesium iodide (99%-Cs) (7789-17-5) CsI; FW: 259.81; white xtl.; m.p. 621°; b.p. 1280°; d. 4.510 <i>hygroscopic</i>	25g 100g 500g
93-5543	Cesium iodide (99.9%-Cs) (7789-17-5) CsI; FW: 259.81; white xtl.; m.p. 621°; b.p. 1280°; d. 4.510 <i>hygroscopic</i>	25g 100g 500g
93-5544	Cesium iodide (99.999%-Cs) PURATREM (7789-17-5) CsI; FW: 259.81; white xtl.; m.p. 621°; b.p. 1280°; d. 4.510 <i>hygroscopic</i>	10g 50g

CESIUM (Compounds)

93-5527 HAZ	Cesium nitrate (99.9%-Cs) (7789-18-6) CsNO ₃ ; FW: 194.91; white xtl.; m.p. 414°; d. 3.685 <i>hygroscopic</i>	10g 50g
93-5545 HAZ	Cesium nitrate (99.99%-Cs) PURATREM (7789-18-6) CsNO ₃ ; FW: 194.91; white xtl.; m.p. 414°; d. 3.685 <i>hygroscopic</i>	10g 50g
93-5528 HAZ	Cesium perchlorate (99.9%-Cs) (13454-84-7) CsClO ₄ ; FW: 232.36; white xtl.; m.p. 250°; d. 3.327 <i>hygroscopic</i>	10g 50g
93-5547	Cesium sulfate (99.9%-Cs) (10294-54-9) Cs ₂ SO ₄ ; FW: 361.87; white xtl.; m.p. 1010°; d. 4.243 <i>hygroscopic</i>	10g 50g
55-5000	2,2,6,6-Tetramethyl-3,5-heptanedionato cesium [Cs(TMHD)] (61346-75-6) CsC ₁₁ H ₁₉ O ₂ ; FW: 316.18; pale yellow powdr.	1g 5g

CHROMIUM (Elemental Forms)

93-2457	Chromium chips (99.8%) (7440-47-3) Cr; FW: 52.01; random pieces; m.p. 1890°; b.p. 2200°; d. 7.20	50g 250g
24-0025	Chromium crystallites (99.996%) (7440-47-3) Cr; FW: 52.01; 2-15 mm; m.p. 1890°; b.p. 2200°; d. 7.20	10g 50g
93-2456	Chromium flakes (99.3%) (7440-47-3) Cr; FW: 52.01; 19 mm and down; m.p. 1890°; b.p. 2200°; d. 7.20	100g 500g
24-0040	Chromium pellets (99.997%) (7440-47-3) Cr; FW: 52.01; 3-5.4 mm; m.p. 1890°; b.p. 2200°; d. 7.20	5g 25g 100g
93-2458 HAZ	Chromium powder (99%) (7440-47-3) Cr; FW: 52.01; -100 mesh; m.p. 1890°; b.p. 2200°; d. 7.20	100g 500g

CHROMIUM (Compounds)

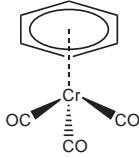
24-0120	Benzene chromium tricarbonyl, 98% (12082-08-5) C ₆ H ₆ Cr(CO) ₃ ; FW: 214.14; yellow xtl.; m.p. 165-166°	1g 5g	
24-0130 amp HAZ	Bis(benzene)chromium, min. 97% (1271-54-1) (C ₆ H ₆) ₂ Cr; FW: 208.22; brown to black xtl.; m.p. 284-285° <i>air sensitive</i>	1g 5g	
24-0135 amp HAZ	Bis(cyclopentadienyl)chromium, min. 95%, sublimed (Chromocene) (1271-24-5) (C ₅ H ₅) ₂ Cr; FW: 182.18; scarlet xtl.; m.p. 172-173° <i>air sensitive</i>	1g 5g	
24-0145 amp HAZ	Bis(ethylbenzene)chromium [mixture of (C₂H₅)_xC₆H₆_nx where x = 0-4] (12212-68-9) [(C ₂ H ₅) _x C ₆ H ₆ _n] ₂ Cr; dark brown liq.; b.p. 140-160°/1mm; d. 1.14-1.18 <i>air sensitive</i>	1g 5g 25g	
24-0147 amp HAZ	Bis(ethylcyclopentadienyl)chromium, min. 98% (55940-03-9) [(C ₂ H ₅)C ₅ H ₄] ₂ Cr; FW: 238.29; red liq.; b.p. 95-98°/1.0mm; d. 1.15 <i>air sensitive</i>	1g 5g	
24-0150 amp HAZ	Bis(pentamethylcyclopentadienyl)chromium, min. 95% (Decamethylchromocene) (74507-61-2) [(CH ₃) ₅ C ₅] ₂ Cr; FW: 322.45; brown powdr. <i>air sensitive</i>	1g 5g	
24-0153 amp HAZ	Bis(i-propylcyclopentadienyl)chromium, min. 98% (329735-69-5) [(C ₃ H ₇)C ₅ H ₄] ₂ Cr; FW: 266.35; red liq. <i>air sensitive</i>	1g 5g	

CHROMIUM (Compounds)

24-0154 amp HAZ	Bis(tetramethylcyclopentadienyl)chromium, min. 98% (82066-37-3) [(CH ₃) ₄ C ₅ H ₂] ₂ Cr; FW: 294.40; red xtl. <i>air sensitive</i>	1g 5g
24-0000 NEW	Chromium(III) acetate, 97% (1066-30-4) Cr(CH ₃ CO ₂) ₃ ; FW: 229.13; green powdr.	100g 500g
93-2401	Chromium(III) acetate, basic (39430-51-8) Cr ₃ (OH) ₂ (OOCCH ₃) ₇ ; FW: 603.32; blue to green powdr.	250g 1kg
24-0155	Chromium(III) acetate solution, 11.2-11.8% Cr (1066-30-4) Cr(OOCCCH ₃) ₃ ; FW: 229.13; liq.; d. 1.28	1kg 4kg
24-0160	Chromium(III) acetylacetonate, 97.5% (21679-31-2) Cr(CH ₃ COCHCOCH ₃) ₃ ; FW: 349.33; maroon xtl.; m.p. 214°; b.p. subl. 100°/0.2mm	50g 250g 1kg
24-0185 HAZ	Chromium arsenide (99%-Cr) (12254-85-2) Cr ₂ As ₃ ; FW: 178.98; black powdr.	5g 25g
24-0190 NEW HAZ	Chromium(III) bromide, anhydrous flakes, 99% (10031-25-1) CrBr ₃ ; FW: 291.71; dark-green flakes <i>hygroscopic</i> For detailed technical note visit strem.com .	1g 5g
93-2415 HAZ	Chromium(III) bromide hexahydrate (13478-06-3) CrBr ₃ ·6H ₂ O; FW: 291.69 (399.81); green xtl.; d. 5.4	5g 25g
93-2432	Chromium carbide, 99.7% (12012-35-0) Cr ₃ C ₂ ; FW: 180.02; gray powdr.; m.p. 1890°; b.p. 3800°; d. 6.68	50g 250g
24-0183 NEW HAZ	Chromium carbonyl, 98+% (13007-92-6) Cr(CO) ₆ ; FW: 220.06; white to off-white solid	5g 25g 100g
24-0180 HAZ	Chromium carbonyl, sublimed, 99% (13007-92-6) Cr(CO) ₆ ; FW: 220.06; white xtl.; m.p. 154-155°; d. 1.77 For detailed technical note visit strem.com .	5g 25g 100g 500g
93-2405	Chromium(II) chloride, anhydrous (99.9%-Cr) (10049-05-5) CrCl ₂ ; FW: 122.90; off-white to pale green powdr.; m.p. 824°; d. 2.878 <i>air sensitive, hygroscopic</i>	1g 5g 25g
24-0270 HAZ	Chromium(III) chloride, anhydrous, 99% (10025-73-7) CrCl ₃ ; FW: 158.35; purple xtl.; m.p. ~1150°; b.p. subl. 1300°; d. 2.76 <i>hygroscopic</i>	50g 250g
93-2442 HAZ	Chromium(III) chloride, anhydrous (99.9%-Cr) (10025-73-7) CrCl ₃ ; FW: 158.35; purple flakes (< 1/8"); m.p. ~1150°; b.p. subl. 1300°; d. 2.76 <i>hygroscopic</i>	10g 50g
93-2417 HAZ	Chromium(III) chloride hexahydrate (10060-12-5) CrCl ₃ ·6H ₂ O; FW: 158.35 (266.48); green xtl.; m.p. 83°; d. 1.76	100g 500g
24-0280 HAZ	Chromium(III) chloride tetrahydrofuran adduct, 98% (10170-68-0) CrCl ₃ (C ₄ H ₈ O) ₃ ; FW: 374.67; purple powdr. <i>moisture sensitive</i>	5g 25g
93-2426	Chromium(III) 2-ethylhexanoate, 70% in mineral spirits (8-10% Cr) (3444-17-5) Cr[OOCCH(C ₂ H ₅)C ₄ H ₉] ₃ ; FW: 481.62; green, viscous liq.; f.p. 230°F; d. 1.01	25g 100g
93-2433 HAZ	Chromium(II) fluoride, anhydrous, 95% (10049-10-2) CrF ₂ ; FW: 89.99; green powdr.; m.p. 1100°; b.p. > 1300°; d. 4.11 <i>moisture sensitive</i>	2g 10g
93-2434 HAZ	Chromium(III) fluoride, anhydrous, 98% (7788-97-8) CrF ₃ ; FW: 108.99; green powdr.; m.p. > 1000° <i>moisture sensitive</i>	1g 5g 25g
24-0400	Chromium(III) hexafluoroacetylacetonate, min. 98% (14592-80-4) Cr(CF ₃ COCHCOCF ₃) ₃ ; FW: 673.14; green xtl.; m.p. 83-85°	1g 5g

CHROMIUM (Compounds)

24-2427 NEW HAZ	Chromium (III) naphthenate, 30-40% in heavy naphtha (2% Chromium) (61788-69-0) green liq.	100g 500g
93-2424 HAZ	Chromium(III) naphthenate, ~30% in mineral spirits (2% Cr) (61788-69-0) dark green to brown liq.; f.p. 104°F; d. 0.87	100g 500g
93-2407 HAZ	Chromium(III) nitrate nonahydrate, 99% (7789-02-8) Cr(NO ₃) ₃ ·9H ₂ O; FW: 238.06 (400.15); greenish-black xtl.; m.p. 60°; b.p. 100° dec. <i>hygroscopic</i>	100g 500g
93-2437	Chromium(III) oxide, 98% (1308-38-9) Cr ₂ O ₃ ; FW: 151.99; green pwdr.; m.p. 2435°; b.p. 4000°; d. 5.21	250g 1kg
93-2438	Chromium(III) oxide, 99% (1308-38-9) Cr ₂ O ₃ ; FW: 151.99; green pwdr.; m.p. 2435°; b.p. 4000°; d. 5.21	50g 250g
93-2413	Chromium(III) oxide hydrate, 98% (12182-82-0) Cr ₂ O ₃ ·XH ₂ O; FW: 151.99; green pwdr.	250g 1kg
93-2443 HAZ	Chromium(VI) oxide, 99.5% (1333-82-0) CrO ₃ ; FW: 99.99; red xtl.; m.p. 196°; d. 2.70 <i>moisture sensitive</i>	500g 2kg
93-2414	Chromium(III) sulfate hydrate (15244-38-9) Cr ₂ (SO ₄) ₃ ·XH ₂ O; FW: 392.18; greenish-black pwdr.	50g 250g
24-0800	Chromium(III) tetraphenylporphine chloride (28110-70-5) (C ₄₄ H ₂₈ N ₄)CrCl; FW: 700.18; purple pwdr.	250mg 1g
93-2409 amp HAZ	Chromyl chloride, 99.5% (14977-61-8) CrO ₂ Cl ₂ ; FW: 154.90; red liq.; b.p. 117°; d. 1.911 <i>moisture sensitive</i>	5g 25g
24-0850	(1R,2R)-(-)-[1,2-Cyclohexanediamino-N,N'-bis(3,5-di-t-butylsalicylidene)] chromium(III) chloride (164931-83-3) [C ₃₆ H ₅₂ N ₂ O ₂]CrCl; FW: 632.28; brown pwdr.; m.p. >350° For detailed technical note visit strem.com.	1g 5g
24-0851	(1S,2S)-(+)-[1,2-Cyclohexanediamino-N,N'-bis(3,5-di-t-butylsalicylidene)] chromium(III) chloride (219143-92-7) [C ₃₆ H ₅₂ N ₂ O ₂]CrCl; FW: 632.28; brown pwdr.; m.p. >350°	1g 5g

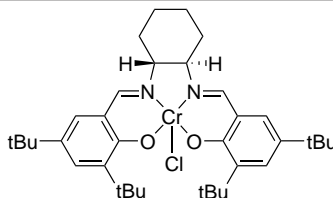

Technical Note:

- See 24-0850 (page 46)

24-0900	Pentamethylcyclopentadienylchromium dicarbonyl dimer, 99% (37299-12-0) [(CH ₃) ₅ C ₅ Cr(CO) ₂] ₂ ; FW: 486.49; deep green xtl.; m.p. 200° dec. <i>air sensitive</i>	1g 5g
93-2444	Tris(ethylenediamine)chromium(III) chloride hemiheptahydrate, min. 98% (16165-32-5) Cr(H ₂ NCH ₂ CH ₂ NH ₂) ₃ Cl ₃ ·3.5H ₂ O; FW: 338.65 (401.71); yellow pwdr.	5g 25g
24-1500	Tris(2,2,6,6-tetramethyl-3,5-heptanedionato)chromium(III), 99% [Cr(TMHD) ₃] (14434-47-0) Cr(C ₁₁ H ₁₉ O ₂) ₃ ; FW: 601.82; purple xtl.; m.p. 230-232°; b.p. dec. 270°	1g 5g

COBALT (Elemental Forms)

27-0200	Cobalt foil (99.9%) (7440-48-4) Co; FW: 58.90; 0.127mm thick, 50mm x 50mm; m.p. 1495°; b.p. 2870°; d. 8.9	1pc 5pcs
27-0300	Cobalt pieces (99.9+%) (7440-48-4) Co; FW: 58.90; 1"-2" square plates; m.p. 1495°; b.p. 2870°; d. 8.9	100g 500g
27-0040 HAZ	Cobalt powder (99.8%) (7440-48-4) Co; FW: 58.90; 0.5-1.5 micron; m.p. 1495°; b.p. 2870°; d. 8.9	50g 250g
93-2761 HAZ	Cobalt powder (99.8%) (7440-48-4) Co; FW: 58.90; -100 mesh; m.p. 1495°; b.p. 2870°; d. 8.9	25g 100g 500g

COBALT (Elemental Forms)

93-2760	Cobalt powder (99.8%) (7440-48-4)	50g
HAZ	Co; FW: 58.90; -400 mesh; m.p. 1495°; b.p. 2870°; d. 8.9	250g
27-0045	Cobalt powder (99.99%) (7440-48-4)	10g
HAZ	Co; FW: 58.90; -100 mesh; m.p. 1495°; b.p. 2870°; d. 8.9	50g

COBALT (Compounds)

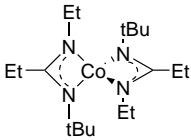
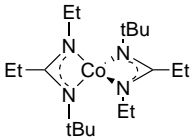
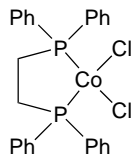
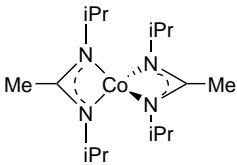
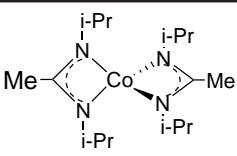
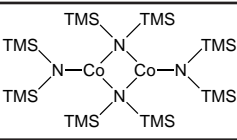
27-0468	Bis(N-t-butyl-N'-ethylpropanimidamidato)cobalt(II), min. 98% (1011477-51-2)	1g 5g
NEW	C ₁₈ H ₃₈ CoN ₄ ; FW: 369.45; blue-green liq. <i>air sensitive, moisture sensitive</i> Note: Product sold under, use subject to, terms and conditions of label license at www.strem.com/harvard2 For detailed technical note visit strem.com .	
27-0469	Bis(N-t-butyl-N'-ethylpropanimidamidato)cobalt(II), min. 98% (99.99%-Co) PURATREM (1011477-51-2)	1g 5g
NEW	C ₁₈ H ₃₈ CoN ₄ ; FW: 369.45; blue-green liq. <i>air sensitive, moisture sensitive</i> Note: Product sold under, use subject to, terms and conditions of label license at www.strem.com/harvard2 For detailed technical note visit strem.com .	
27-0475	Bis(cyclopentadienyl)cobalt(II), min. 98% (Cobaltocene) (1277-43-6)	1g 5g 25g
amp HAZ	(C ₅ H ₅) ₂ Co; FW: 189.12; purplish-black xtl.; m.p. 173° <i>air sensitive, light sensitive, (store cold)</i>	
27-0478	1,2-Bis(diphenylphosphino)ethanedichlorocobalt(II), min. 97% (18498-01-6)	1g 5g
	CoCl ₂ (C ₂₆ H ₂₄ P ₂); FW: 528.26; green powdr. <i>moisture sensitive</i> For detailed technical note visit strem.com .	
27-0485	Bis(N,N'-di-i-propylacetamidinato)cobalt(II), min. 98% Co(iPr-MeAMD)2 (635680-58-9)	250mg 1g 5g
amp	(C ₈ H ₁₇ N ₂) ₂ Co; FW: 341.40; green xtl.; m.p. 84°; b.p. sublimes 50°C (50 mTorr) <i>air sensitive, moisture sensitive</i> Note: Product sold under, use subject to, terms and conditions of label license at www.strem.com/harvard2 .	
Technical Notes:		
1. Precursor with metal nitrogen bonds used for the atomic layer deposition of metals, nitrides, and oxides. See WO 2004/046417A2.		
2. Copper complex used in the vapor phase, atomic layer deposition of Co ₉ S ₈ and its application for super conductors.		
3. Complex used in the atomic layer deposition of cobalt sulfide.		
References:		
1. <i>Nano Letters</i> , 2015 , 15, 6689		
2. <i>ACS Nano</i> , 2015 , 9, 8484		
27-0486	Bis(N,N'-di-i-propylacetamidinato)cobalt(II), min. 98% (99.99%-Co) PURATREM (Co(iPr-MeAMD)₂ (635680-58-9)	250mg 1g 5g
NEW amp HAZ	C ₁₆ H ₃₄ CoN ₄ ; FW: 341.40; green xtl. <i>air sensitive, moisture sensitive</i> Note: Product sold under, use subject to, terms and conditions of label license at www.strem.com/harvard2 .	
27-0515	Bis{[μ-[di(trimethylsilyl)amide]}bis{[di(trimethylsilyl)amide]}]dicobalt(II), 98% (93280-44-5)	250mg 1g 5g
NEW	C ₂₄ H ₇₂ Co ₂ N ₄ Si ₈ ; FW: 759.41; brown solid <i>air sensitive, moisture sensitive</i> For detailed technical note visit strem.com .	
27-1000	Bis(pentamethylcyclopentadienyl)cobalticinium hexafluorophosphate, 98% (79973-42-5)	1g 5g
	[(CH ₃) ₅ C ₅] ₂ Co ⁺ PF ₆ ⁻ ; FW: 474.35; yellow to orange powdr.	

COBALT (Compounds)

27-1050	Chlorotris(triphenylphosphine)cobalt(I), min. 98% (26305-75-9) CoCl(P(C ₆ H ₅) ₃) ₃ ; FW: 881.24; brown powdr. <i>air sensitive, (store cold)</i> For detailed technical note visit strem.com .	1g 5g
93-2701	Cobalt(II) acetate tetrahydrate, 98+% (6147-53-1) Co(OOCCH ₃) ₂ ·4H ₂ O; FW: 177.00 (249.08); pink xtl.; d. 1.705	100g 500g 2kg
93-2703	Cobalt(II) acetylacetonate hydrate (123334-29-2) Co(CH ₃ COCHCOCH ₃) ₂ ·XH ₂ O; FW: 257.18; pink powdr.	50g 250g
93-2702	Cobalt(III) acetylacetonate, 98+% (21679-46-9) Co(CH ₃ COCHCOCH ₃) ₃ ; FW: 356.30; green xtl.; m.p. 216°; b.p. subl. 150°/1mm	10g 50g 250g
93-2731	Cobalt(II) bromide hydrate (85017-77-2) CoBr ₂ ·XH ₂ O; FW: 218.75; violet xtl.; d. -2.462	50g 250g
93-2733	Cobalt(II) carbonate hydrate (99%-Co) (Co min. 45.5%) (513-79-1) CoCO ₃ ·XH ₂ O; FW: 118.94; pink powdr.; d. 4.13	50g 250g 1kg
27-0400 HAZ	Cobalt carbonyl (Dicobalt octacarbonyl) (Stabilized with 1-5% hexanes) (10210-68-1) Co ₂ (CO) ₈ ; FW: 341.95; dark orange xtl.; m.p. 51-52° dec.; f.p. -9°F (hexane); d. 1.73 <i>air sensitive, (store cold)</i> For detailed technical note visit strem.com .	5g 25g 100g 500g
93-2721 HAZ	Cobalt(II) chloride, anhydrous, 99+% (7646-79-9) CoCl ₂ ; FW: 129.84; blue powdr.; m.p. 724°; b.p. 1049°; d. 3.356 <i>hygroscopic</i>	25g 100g
27-0405 NEW HAZ	Cobalt(II) chloride, anhydrous (99.999%-Co) PURATREM (7646-79-9) CoCl ₂ ; FW: 129.84; blue powdr. <i>hygroscopic</i>	1g 5g 25g
93-2734	Cobalt(II) chloride hexahydrate, 98+% (7791-13-1) CoCl ₂ ·6H ₂ O; FW: 129.84 (237.93); red xtl.; m.p. 86°; d. 1.924	250g 1kg
93-2735	Cobalt(II) chloride hexahydrate (99.999%-Co) PURATREM (7791-13-1) CoCl ₂ ·6H ₂ O; FW: 129.84 (237.93); red xtl.; m.p. 86°; d. 1.924	5g 25g
93-2707	Cobalt(II) citrate hydrate (866-81-9) Co ₃ (C ₆ H ₅ O ₇) ₂ ·XH ₂ O; FW: 555.01; light purple powdr.	250g 1kg
27-0350 NEW	Cobalt(II) dibromo(1,2-dimethoxyethane), min. 98% (18346-57-1) CoBr ₂ ·CH ₃ O(CH ₂) ₂ OCH ₃ ; FW: 308.86; blue powdr. <i>moisture sensitive</i> For detailed technical note visit strem.com .	1g 5g

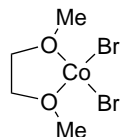
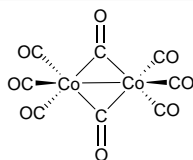

COBALT (Compounds)**27-0900 Cobalt(II) ethyl/butyl phosphonate Silica (PhosphonicS POCO)**blue solid; SA: >350 m²/g

Note: Sold in collaboration with PhosphonicS Ltd. for research purposes only. PhosphonicS Metal Oxidation Catalyst Kit component.

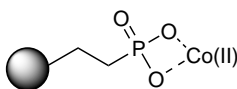
5g
25g

Technical Note:

- Catalyst used for oxidation of a wide variety allylic alcohols and alkene substrates, including complex steroids.

Particle size range: 70-200 microns

Average pore size: 60Å

Effective loadings: 0.3 to 0.5 mmol/g

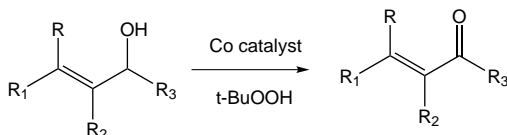
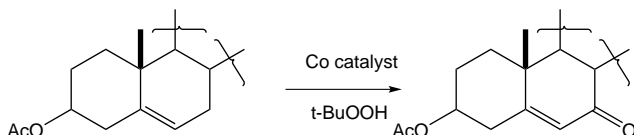
Tech. Note (1)
Ref. (1)Tech. Note (1)
Ref. (2)

References:

- Tetrahedron Lett.*, **2004**, 45, 4465
- Tetrahedron Lett.*, **2003**, 44, 4283

27-0449 HAZ	Cobalt 2-ethylhexanoate, ~65% in mineral spirits (12% Co) (136-52-7) Co[OOCCH(C ₂ H ₅)C ₄ H ₉] ₂ ; FW: 345.42; purple liq.; f.p. 104°F; d. 1.01	50g 250g 1kg
93-2738 HAZ	Cobalt(II) fluoride, anhydrous, 99% (10026-17-2) CoF ₂ ; FW: 96.93; pink pwdr.; m.p. ~1200°; b.p. 1400°; d. 4.46 <i>hygroscopic</i>	10g 50g
93-2740 HAZ	Cobalt(III) fluoride, 99% (10026-18-3) CoF ₃ ; FW: 115.93; tan pwdr.; d. 3.88 <i>hygroscopic</i>	10g 50g
93-2741	Cobalt(II) hydroxide (97%-Co) (21041-93-0) Co(OH) ₂ ; FW: 92.96; pink pwdr.; m.p. dec.; d. 3.597	50g 250g
93-2743	Cobalt(II) iodide, anhydrous, min. 95% (99.5%-Co) (15238-00-3) CoI ₂ ; FW: 312.74; -60 mesh black pwdr.; m.p. 515° (vac.); b.p. 570° (vac.); d. 5.68 <i>hygroscopic</i>	10g 50g
93-2744	Cobalt(II) molybdate, anhydrous (99.9%-Co) (13762-14-6) CoMoO ₄ ; FW: 218.87; -325 mesh green pwdr.	2g 10g
93-2710 HAZ	Cobalt naphthenate, ~53% in mineral spirits (6% Co) (61789-51-3) dark liq.; f.p. 104°F; d. 0.93	500g 2kg
93-2730 HAZ	Cobalt(II) nitrate hexahydrate, 99% (10026-22-9) Co(NO ₃) ₂ ·6H ₂ O; FW: 182.99 (291.05); red xtl.; m.p. 55-56°; d. 1.87	100g 500g
93-2746 HAZ	Cobalt(II) nitrate hexahydrate (99.999%-Co) PURATREM (10026-22-9) Co(NO ₃) ₂ ·6H ₂ O; FW: 182.99 (291.05); red to purple xtl.; m.p. 55-56°; d. 1.87	5g 25g
93-2712	Cobalt(II,III) oxide, 99.5% (1308-06-1) Co ₃ O ₄ ; FW: 240.80; black pwdr.	25g 100g 500g
27-0490	Cobalt(II,III) oxide (99.9985%-Co) PURATREM (1308-06-1) Co ₃ O ₄ ; FW: 240.80; gray to black pwdr.	5g 25g
27-0480	Cobalt oxide-molybdenum oxide on alumina (3.5% CoO, 14% MoO₃) (1308-06-1) 1/8" extrusions; SA: ~244m ² /g	100g 500g
93-2747 HAZ	Cobalt(II) perchlorate hexahydrate, 98+% (13478-33-6) Co(ClO ₄) ₂ ·6H ₂ O; FW: 257.84 (365.93); red xtl. <i>hygroscopic</i>	50g 250g

COBALT (Compounds)

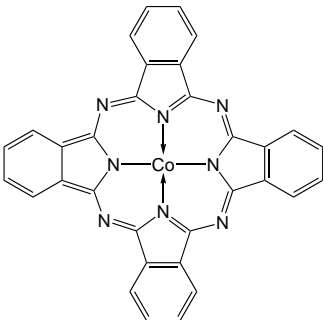
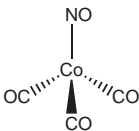
93-2713	Cobalt(II) phosphate hydrate (10294-50-5) Co ₃ (PO ₄) ₂ ·XH ₂ O; FW: 366.74; purple powdr.; d. 2.769	50g 250g
27-0488	Cobalt(II) phthalocyanine (3317-67-7) (C ₃₂ H ₁₆ N ₈)Co; FW: 571.47; purple xtl.	1g 5g
		
93-2714	Cobalt stearate (9-10% Co) (1002-88-6) Co(O ₂ C ₁₈ H ₃₅) ₂ ; FW: 625.89; purple pellets	500g 2kg
93-2749	Cobalt(II) sulfate heptahydrate, 98+% (10026-24-1) CoSO ₄ ·7H ₂ O; FW: 155.00 (281.10); pink to red xtl.; m.p. 96.8°; d. 1.948	100g 500g
93-2750	Cobalt(II) sulfate heptahydrate (99.999%-Co) PURATREM (10026-24-1) CoSO ₄ ·7H ₂ O; FW: 155.00 (281.10); pink to red xtl.; m.p. 96.8°; d. 1.948	10g 50g
93-2751	Cobalt(II) sulfide (99.5%-Co) (1317-42-6) CoS; FW: 91.00; -200 mesh black powdr.; d. 5.45 <i>moisture sensitive</i>	5g 25g
27-0465	Cobalt(II) meso-tetra(4-methoxyphenyl)porphine, min. 96% (28903-71-1) (C ₄₈ H ₃₆ N ₄ O ₄)Co; FW: 791.74; purple powdr.	1g 5g
27-0470	Cobalt(II) meso-tetraphenylporphine (14172-90-8) (C ₄₄ H ₂₈ N ₄)Co; FW: 671.66; rust colored xtl.	250mg 1g 5g
93-2753	Cobalt(II) thiocyanate, min. 95% (3017-60-5) Co(SCN) ₂ ; FW: 175.09; brown powdr.	10g 50g
27-0500	Cobalt tricarbonyl nitrosyl (14096-82-3) Co(CO) ₃ NO; FW: 172.97; dark red liq.; b.p. 50°; d. 1.47 HAZ <i>air sensitive, (store cold)</i> Note: Volatile cobalt precursor for the molecular layer deposition of cobalt metal.	1g 5g 25g
		
93-2754	Cobalt(II) tungstate (99.9%-Co) (10101-58-3) CoWO ₄ ; FW: 306.78; -100 mesh gray powdr.; d. 8.42	10g 50g
27-0477	Cobalt-dppe heterogeneous water oxidation catalyst (~17% Co) Co ₄ (dppe) ₂ (CO)(OH) ₆ (H ₂ O) ₆ ; light-brown powdr. NEW Note: Sold under license from Catalytic Innovations, LLC for research purposes only. US Patent Publication No. US20150065339 A1.	100mg 500mg
27-0410	Cobalticinium hexafluorophosphate, 98% (12427-42-8) (C ₅ H ₅) ₂ Co ⁺ PF ₆ ⁻ ; FW: 334.09; yellow xtl.	1g 5g

COBALT (Compounds)

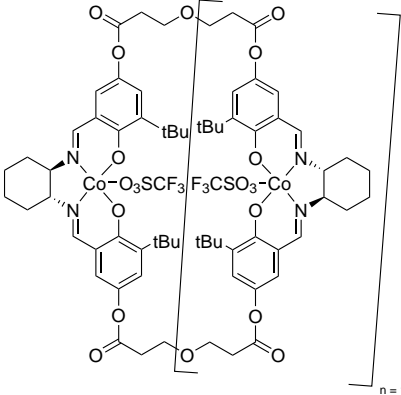
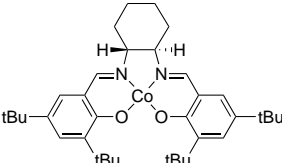
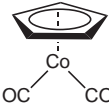
27-0495	Cyclic-Oligo Bis[(1R,2R)-(+)-1,2-cyclohexanediamino-N,N'-bis(3,3'-di-t-butylsalicylidene) cobalt(III)triflate]-5,5'-bis(2-carboxyethyl)ether (647036-07-5) $C_{70}H_{84}Co_2F_6N_4O_{20}S_2$; FW: 1597.42; black xtl. For detailed technical note visit strem.com .	100mg 500mg
		
27-0496	Cyclic-Oligo Bis[(1S,2S)-(-)-1,2-cyclohexanediamino-N,N'-bis(3,3'-di-t-butylsalicylidene) cobalt(III)triflate]-5,5'-bis(2-carboxyethyl)ether (1252661-94-1) $C_{70}H_{84}Co_2F_6N_4O_{20}S_2$; FW: 1597.42; black xtl. For detailed technical note visit strem.com .	100mg 500mg
27-0525	(1R,2R)-(-)-1,2-Cyclohexanediamino-N,N'-bis(3,5-di-t-butylsalicylidene)cobalt(II) (176763-62-5) $C_{36}H_{52}CoN_2O_2$; FW: 603.76; red-brown powdr.; m.p. 406-412° For detailed technical note visit strem.com .	1g 5g 25g
		
27-0526	(1S,2S)-(+)-1,2-Cyclohexanediamino-N,N'-bis(3,5-di-t-butylsalicylidene) cobalt(II) (188264-84-8) $C_{36}H_{52}CoN_2O_2$; FW: 603.76; red-brown powdr.; m.p. 409-412°	1g 5g 25g
Technical Note:	1. See 27-0525 (page 51)	
27-0528	(1S,2S)-(+)-1,2-Cyclohexanediamino-N,N'-bis(3,5-di-t-butylsalicylidene)cobalt(III) p-toluenesulfonate monohydrate (672306-06-8) $C_{43}H_{59}CoN_2O_5S \cdot H_2O$; FW: 774.94; green solid For detailed technical note visit strem.com .	1g 5g
27-0550	Cyclopentadienylcobalt dicarbonyl, min. 95% (12078-25-0) $C_5H_5Co(CO)_2$; FW: 180.05; dark red liq.; b.p. 37-38.5°/2 mm; f.p. 80°F; d. 1.35 <i>air sensitive, (store cold)</i> For detailed technical note visit strem.com .	2g 10g
		
27-0554	Dichloro[1,1'-bis(diphenylphosphino)ferrocene]cobalt(II), 99% (67292-36-8) $[(C_5H_4P(C_6H_5)_2)_2Fe]CoCl_2$; FW: 684.22; green microxtls. For detailed technical note visit strem.com .	1g 5g
27-0575	Dichlorobis(triphenylphosphine)cobalt(II), 98% (14126-40-0) $CoCl_2[P(C_6H_5)_3]_2$; FW: 654.41; blue powdr. <i>air sensitive</i> For detailed technical note visit strem.com .	1g 5g 25g
NEW		
27-0770	(3,3-Dimethyl-1-butyne)dicobalt hexacarbonyl, 98% (56792-69-9) $Co_2(CO)_6[HC \equiv C(C(CH_3)_3)]$; FW: 368.07; dark red liq. <i>air sensitive</i>	250mg 1g
93-2708	Hexaamminecobalt(III) chloride (99.99%-Co) PURATREM (10534-89-1) $[Co(NH_3)_6]Cl_3$; FW: 267.46; orange powdr.; m.p. 217°; d. 1.710	10g 50g
93-0386	Lithium cobalt(III) oxide, min. 98% (12190-79-3) See page 116	

COBALT (Compounds)

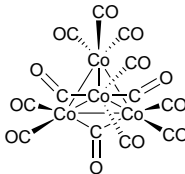
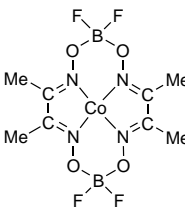
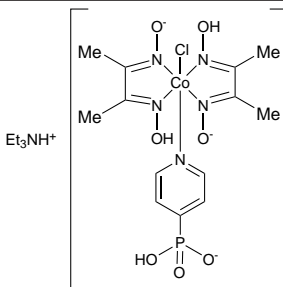
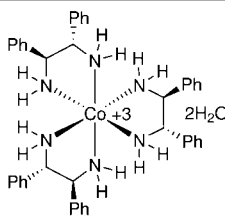
96-6770	PhosphonicS Metal Oxidation Catalyst Kit See page 488	
05-2500	Sodium cobaltcarborane (99492-72-5) See page 417	
11-2700	Sodium(cyclopentadienyl)tris(dimethylphosphito)cobaltate(I), 98% (82149-18-6) See page 422	
27-1950 HAZ	Tetracobalt dodecacarbonyl, min. 98% (17786-31-1) $\text{Co}_4(\text{CO})_{12}$; FW: 571.85; black xtl.; m.p. 60° dec.; d. 2.09 <i>air sensitive, (store cold)</i> For detailed technical note visit strem.com .	 1g 5g 25g
27-1965	N,N',N'',N'''-(Tetrafluorodiborato) bis[μ-(2,3-butanedi- onedioximato)]cobalt(II), min. 98% (26220-72-4) $\text{C}_8\text{H}_{12}\text{B}_2\text{CoF}_4\text{N}_4\text{O}_4$; FW: 384.75; brown solid Note: Limited quantities available.	 100mg 500mg
Technical Note: 1. Effective catalyst for high conversion, chain transfer polymerization of methyl methacrylate.		
References: 1. <i>Macromolecular Engineering</i> , 2011 , 5, 9, 10, 404 2. <i>Polymer Chemistry</i> , 2011 , 2, 815 3. <i>J. Applied Polymer Science</i> , 2004 , 91, 1375		
27-3015 NEW	Triethylammonium {chlorobis(dimethylgly- oximato)(4-hydrogenphosphonatepyridinyl) cobaltate(III)} (1280199-86-1) $\text{C}_{19}\text{H}_{35}\text{ClCoN}_6\text{O}_7\text{P}$; FW: 584.88; light-brown solid For detailed technical note visit strem.com .	 5mg 25mg
27-4010 NEW	lambda-Tris[(1S,2S)-1,2-diphenyl-1,2-eth- anediamine]cobalt(III) chloride tetrakis[3,5-bis(trifluoromethyl)phenyl] borate dihydrate SKJ-1 (1542135-29-4) $\text{C}_{74}\text{H}_{60}\text{BCl}_2\text{CoF}_{24}\text{N}_6$; FW: 1629.92(1665.92); orange powdr. Note: U.S. Patent 14/417655	 50mg 250mg $2\text{Cl}^- \text{B}[\text{C}_6\text{H}_3(\text{CF}_3)_2]_4^-$

COBALT (Compounds)

27-4011	delta-Tris[(1<i>S</i>,2<i>S</i>)-1,2-diphenyl-1,2-ethanediamine]cobalt(III) chloride tetrakis[3,5-bis(trifluoromethyl)phenyl]borate trihydrate SKJ-3 <i>(1867120-15-7)</i> $C_{66}H_{48}BCl_2CoF_{20}N_6$; FW: 1445.74(1501.80); orange solid Note: U.S. Patent 14/417655	50mg 250mg
---------	---	---------------

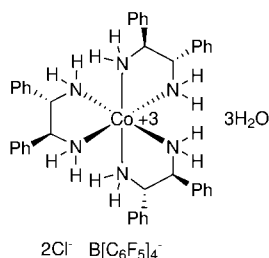
NEW

27-3000	Tris(2,2,6,6-tetramethyl-3,5-heptanedionato)cobalt(III), 99% (99.9+%-Co) [Co(TMHD)] <i>(14877-41-9)</i> $Co(C_{11}H_{19}O_2)_3$; FW: 608.74; green powdr.; m.p. 254-256°; b.p. 250° dec. (subl. 120°/0.5mm)	1g 5g 25g
---------	--	-----------------

COPPER (Elemental Forms)

93-2992	Copper foil (99%) <i>(7440-50-8)</i> Cu; FW: 63.54; 0.127 mm thick x 200 mm wide; m.p. 1083°; d. 8.92	200 x 200mm 1000 x 200mm
93-2994	Copper foil (99.9%) <i>(7440-50-8)</i> Cu; FW: 63.54; 0.05 mm thick x 300 mm wide; m.p. 1083°; d. 8.92	50 x 300mm 250 x 300mm
93-2970	Copper foil (99.9%) <i>(7440-50-8)</i> Cu; FW: 63.54; 0.025 mm thick x 150 mm wide; m.p. 1083°; d. 8.92	50 x 150mm 250 x 150mm
93-2991	Copper foil (99.9985%) <i>(7440-50-8)</i> Cu; FW: 63.54; 0.5 mm thick; m.p. 1083°; d. 8.92	50 x 50mm 100 x 100mm
29-0092	Copper nanoparticles, pure, (<20nm) in acetone at 100mg/L (surfactant and reactant-free) <i>(7440-50-8)</i> See page 150	
29-0050 HAZ	Copper powder (99%) <i>(7440-50-8)</i> Cu; FW: 63.54; -325 mesh; m.p. 1083°; d. 8.92	500g 2kg
93-2999 HAZ	Copper powder (99.5%) <i>(7440-50-8)</i> Cu; FW: 63.54; -100 mesh; m.p. 1083°; d. 8.92	100g 500g 2kg
29-0075 HAZ	Copper powder, spherical (99.9%) <i>(7440-50-8)</i> Cu; FW: 63.54; -100 mesh; m.p. 1083°; d. 8.92	250g 1kg
93-2971 HAZ	Copper powder (99.999%) <i>(7440-50-8)</i> Cu; FW: 63.54; -100 mesh (under argon); m.p. 1083°; d. 8.92	5g 25g
29-0080	Copper rod (99.999%) <i>(7440-50-8)</i> Cu; FW: 63.54; 9.5mm dia. (~6.3g/cm); m.p. 1083°; d. 8.92	25g 100g 500g
93-2997	Copper shot (99.9%) <i>(7440-50-8)</i> Cu; FW: 63.54; 1-10 mm; m.p. 1083°; d. 8.92	250g 1kg
93-2998	Copper shot (99.999%) <i>(7440-50-8)</i> Cu; FW: 63.54; 2-8 mm; m.p. 1083°; d. 8.92	50g 250g
29-0085	Copper shot (99.9999%) <i>(7440-50-8)</i> Cu; FW: 63.54; 6 mm dia.; m.p. 1083°; d. 8.92	10g 50g
29-0090	Copper turnings (99+%) <i>(7440-50-8)</i> Cu; FW: 63.54; metal turnings; m.p. 1083°; d. 8.92	100g 500g
93-2972	Copper wire (99.99%) <i>(7440-50-8)</i> Cu; FW: 63.54; 0.25 mm dia.; m.p. 1083°; d. 8.92	5m 25m
93-2973	Copper wire (99.999+%) <i>(7440-50-8)</i> Cu; FW: 63.54; 0.76 mm dia.; m.p. 1083°; d. 8.92	1m 5m
93-2974	Copper wire cloth, 40 mesh <i>(7440-50-8)</i> Cu; FW: 63.54; 900mm wide (0.25mm wire dia.); m.p. 1083°; d. 8.92	100 x 900mm 500 x 900mm
29-2760 HAZ	Sponge copper catalyst (Raney®-type) <i>(7440-50-8)</i> 50% aqueous slurry <i>air sensitive</i>	25g 100g 500g

COPPER (Compounds)

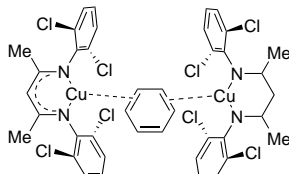
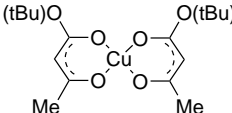
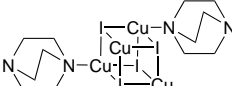
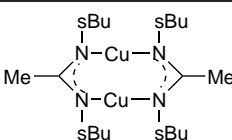
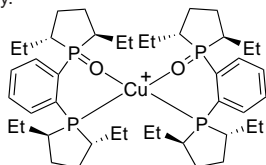
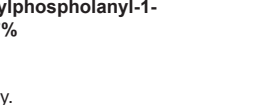
29-7050	<p>μ-Benzenebis[N,N'-(1,3-dimethyl-1,3-propanediylidene)bis(2,6-dichlorobenzenamino)]dicopper(I), benzene adduct, min. 98% (1119821-62-3) $C_{34}H_{26}Cl_6Cu_2N_4 \cdot 0.8C_6H_6$; FW: 963.80; pale yellow solid <i>air sensitive, moisture sensitive, (store cold)</i> Note: Sold under license from Georgetown University for noncommercial research use only. Patent pending.</p>		250mg 1g
Technical Note:			
1. High yield C-H amination of unactivated C-H bonds with 1-adamantylazide.			
References:			
1. <i>Angew. Chem. Int. Ed.</i> , 2008 , 47, 9961			
2. <i>Inorg. Chem.</i> , 2004 , 43, 6537			
29-7110	<p>Bis(t-butylacetoacetato)copper(II), 99% (23670-45-3) $C_{16}H_{26}CuO_6$; FW: 377.92; green xtls.</p>		1g 5g 25g
Technical Notes:			
1. A new, non-fluorinated, copper CVD precursor exhibiting a higher sublimation rate and lower decomposition rate than-Cu(dpm) ₂			
2. Copper CVD precursor used in the deposition of copper films with low carbon content (Ref. 2).			
References:			
1. <i>J. Mater. Res.</i> , 1998 , 13, 687			
2. <i>Surface and Coating Technology</i> , 2002 , 150, 205			
29-3015	<p>Bis(1,4-diazabicyclo [2.2.2]octane)tetra (copper(I) iodide) (CuI)₂(DABCO)₂ (928170-42-7) $C_{12}H_{24}Cu_4I_4N_4$; FW: 986.15; yellow powdr. <i>air sensitive</i></p>		500mg 2g
29-7100 amp	<p>Bis(N,N'-di-sec-butylacetamidinato)dicopper(I), 99% (695188-31-9) ($C_{10}H_{21}N_2$)₂Cu₂; FW: 465.67; white to off-white xtl. <i>air sensitive, moisture sensitive, (store cold)</i> Note: Product sold under, use subject to, terms and conditions of label license at www.strem.com/harvard2.</p>		250mg 1g 5g
Technical Note:			
1. Precursor with metal nitrogen bonds used for the atomic layer deposition of metals, metal nitrides, and oxides. See WO 2004/046417A2.			
References:			
1. <i>Chem. Mater.</i> , 2011 , 23, 4411			
2. <i>J. Am. Chem. Soc.</i> , 2009 , 131, 18159			
3. <i>Appl. Phys. Lett.</i> , 2009 , 94, 123107, 1			
4. <i>Inorg. Chem.</i> , 2005 , 44, 1728			
29-3007	<p>Bis[[1-(2R,5R)-2,5-diethylphospholanyl]-[2-(2R,5R)-2,5-diethylphospholanyl-1-oxide]benzene)copper(I) trifluoromethanesulfonate, min. 97% $C_{46}H_{72}CuF_3O_5P_4S$; FW: 969.55; white to beige solid <i>air sensitive</i> Note: Sold under license from Kanata for research purposes only.</p>		100mg 500mg
29-3008	<p>Bis[[1-(2S,5S)-2,5-diethylphospholanyl]-[2-(2S,5S)-2,5-diethylphospholanyl-1-oxide]benzene)copper(I) trifluoromethanesulfonate, min. 97% $C_{46}H_{72}CuF_3O_5P_4S$; FW: 969.55; white to beige solid <i>air sensitive</i> Note: Sold under license from Kanata for research purposes only.</p>		100mg 500mg

COPPER (Compounds)

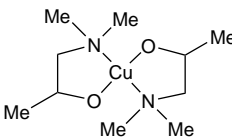
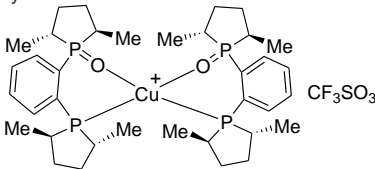
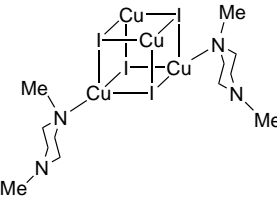
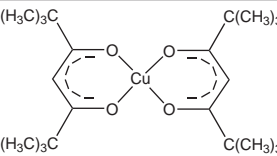
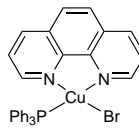
29-7120 amp	Bis(dimethylamino-2-propoxy)copper(II), min. 97% Cu(dmap)₂ (185827-91-2) Cu(C ₅ H ₁₂ NO) ₂ ; FW: 267.86; purple xtl. <i>air sensitive, moisture sensitive</i> For detailed technical note visit strem.com .		250mg 1g
29-3002	Bis[[1-(2R,5R)-2,5-dimethylphospholanyl]-[2-(2R,5R)-2,5-dimethylphospholanyl-1-oxide]benzene]copper(I) trifluoromethanesulfonate, min. 97% (874013-62-4) C ₃₇ H ₅₆ CuF ₃ O ₅ P ₄ S; FW: 857.34; white to beige solid <i>air sensitive</i> Note: Sold under license from Kanata for research purposes only.		100mg 500mg
29-3003	Bis[[1-(2S,5S)-2,5-dimethylphospholanyl]-[2-(2S,5S)-2,5-dimethylphospholanyl-1-oxide]benzene]copper(I) trifluoromethanesulfonate, min. 97% C ₃₇ H ₅₆ CuF ₃ O ₅ P ₄ S; FW: 857.34; white to beige solid <i>air sensitive</i> Note: Sold under license from Kanata for research purposes only.		100mg 500mg
29-0550	Bis(N,N'-dimethylpiperazine)tetra[copper(I) iodide], 98% MOF (1401708-91-5) (CuI) ₄ (C ₈ H ₁₄ N ₂) ₂ ; FW: 990.18; white powdr. <i>moisture sensitive, (store cold)</i>		500mg 2g
Technical Note: 1. The copper iodide, N,N'dimethylpiperazine complex is a 3D photoluminescent, fairly open network, with a lambda max excitation of 321 nm and a lambda max emission of 525nm.			
References: 1. <i>Dalton Trans.</i> , 2012 , <i>41</i> , 11663			
29-8400	Bis(6,6,7,7,8,8,8-heptafluoro-2,2-dimethyl-3, 5-octanedionate)copper(II) [Cu(FOD)₂] (80289-21-0) Cu(C ₁₀ H ₁₀ F ₇ O ₂) ₂ ; FW: 653.92; blue to purple powdr.; m.p. 68-69°; b.p. dec. 280° (subl. 100°/0.1mm) <i>moisture sensitive</i>		1g 5g
29-3000	Bis(2,2,6,6-tetramethyl-3,5-heptanedionato)copper(II), 99% [Cu(TMHD)₂] (14040-05-2) Cu(C ₁₁ H ₁₉ O ₂) ₂ ; FW: 430.05; blue xtl.; m.p. 198°; b.p. dec. 315° (subl. 88°/0.05mm)		1g 5g 25g
29-3100 HAZ	Bis(triphenylphosphine)copper(I) nitrate, 99% (106678-35-7) [(C ₆ H ₅) ₃ P] ₂ Cu•NO ₃ ; FW: 650.12; white powdr.		5g 25g
29-4000	Bromo(1,10-phenanthroline)(triphenylphosphine)copper(I), min. 97% (25753-84-8) CuBr(C ₁₂ H ₈ N ₂)P(C ₆ H ₅) ₃ ; FW: 585.94; yellow powdr. For detailed technical note visit strem.com .		1g 5g
25-2900	Carulite® Catalyst (185036-38-8) See page 125		

COPPER (Compounds)

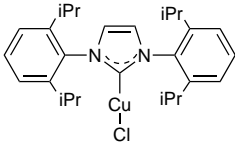
29-4050	Chloro[1,3-bis(2,6-di-i-propylphenyl)imidazol-2-ylidene]copper(I), 98% (578743-87-0) C ₂₇ H ₃₆ ClCuN ₂ ; FW: 487.59; white powd. <i>air sensitive</i> For detailed technical note visit strem.com .		500mg 2g
93-2989	Copper(I) acetate, 97% (598-54-9) CuOOCCH ₃ ; FW: 122.59; beige to light green powd. <i>moisture sensitive</i>		2g 10g 50g
93-2988	Copper(II) acetate, anhydrous, min. 97% (142-71-2) Cu(OOCCH ₃) ₂ ; FW: 181.64; green to blue powd. <i>hygroscopic</i>		25g 100g
93-2901 HAZ	Copper(II) acetate monohydrate, 98+% (ACS) (6046-93-1) Cu(OOCCH ₃) ₂ ·H ₂ O; FW: 181.64 (199.65); green to blue powd.; m.p. 115°; b.p. 240° dec.; d. 1.822		50g 250g 1kg
93-2968	Copper(II) acetylacetonate, 98+% (13395-16-9) Cu(CH ₃ COCHCOCH ₃) ₂ ; FW: 261.77; blue powd.; m.p. 284-285° dec.; b.p. dec. 284° (subl. 78°/0.05mm)		50g 250g
93-2907	Copper(I) bromide, min. 98% (7787-70-4) CuBr; FW: 143.45; off-white to pale-green powd.; m.p. 492°; b.p. 1345°; d. 4.98 <i>hygroscopic</i>		50g 250g 1kg
29-0225 NEW	Copper(I) bromide, dimethyl sulfide complex, 99% (54678-23-8) BrC ₂ CuH ₆ S; FW: 205.59; light-green powd. <i>moisture sensitive</i>		5g 25g
93-2908	Copper(II) bromide, 99% (7789-45-9) CuBr ₂ ; FW: 223.37; gray powd.; m.p. 498°; d. 4.77 <i>hygroscopic</i>		50g 250g
93-2909	Copper(II) i-butyrate, 99% (15432-56-1) Cu(OOCC ₃ H ₇) ₂ ; FW: 237.74; blue powd.		10g 50g
93-2911	Copper(II) carbonate, basic (12069-69-1) CuCO ₃ ·Cu(OH) ₂ ; FW: 221.11; green to blue powd.; m.p. 200° dec.; d. 4.0		500g 2kg
93-2914 HAZ	Copper(I) chloride, anhydrous, 97+% (7758-89-6) CuCl; FW: 98.99; light brown powd.; m.p. 430°; b.p. 1490°; d. 4.14 <i>air sensitive, light sensitive</i>		250g 1kg
29-0360 HAZ	Copper(I) chloride (99.99%-Cu) PURATREM (7758-89-6) CuCl; FW: 98.99; light-gray to pale green solid; m.p. 430°; b.p. 1490°; d. 4.14 <i>air sensitive, light sensitive</i>		10g 50g
93-2912 HAZ	Copper(II) chloride, anhydrous, min. 98% (7447-39-4) CuCl ₂ ; FW: 134.44; reddish-brown powd.; m.p. 620°; d. 3.386 <i>hygroscopic</i>		100g 500g
93-2913 HAZ	Copper(II) chloride dihydrate, 99+% (ACS) (10125-13-0) CuCl ₂ ·2H ₂ O; FW: 134.44 (170.48); green xtl.; d. 2.54		250g 1kg
93-2985 HAZ	Copper(II) chloride dihydrate (99.999%-Cu) PURATREM (10125-13-0) CuCl ₂ ·2H ₂ O; FW: 134.44 (170.48); green xtl.; d. 2.54		10g 50g
29-0410	Copper chromite, barium promoted (62-64% Cr₂CuO₄, 22-24% CuO, 6%BaO, 0-4% Graphite, 1% CrO₃, 1% Cr₂O₃) (12018-10-9) CuO/Cr ₂ CuO ₄ ; FW: 79.55/231.53; black pellets; SA: 45-50 m ² /g		100g 500g
93-2916 HAZ	Copper(I) cyanide, 99% (544-92-3) CuCN; FW: 89.56; off-white to pale green powd.; m.p. 473° (N ₂); b.p. dec.; d. 2.92 <i>air sensitive</i>		100g 500g
93-2920	Copper(II) ethylacetoacetate, 99% (14284-06-1) Cu(CH ₃ COCHCOC ₂ H ₅) ₂ ; FW: 321.82; green to blue powd.		5g 25g
29-2941	Copper(II) 2-ethylhexanoate (solvent free - 16-19% Cu) (149-11-1) Cu[OOCCH(C ₂ H ₅)C ₄ H ₉] ₂ ; FW: 349.96; blue powd.		5g 25g 100g
93-2923 HAZ	Copper(II) fluoride, anhydrous, 99% (7789-19-7) CuF ₂ ; FW: 101.54; off-white powd.; m.p. 780°; b.p. 950° dec.; d. 4.23 <i>hygroscopic</i>		5g 25g

COPPER (Compounds)

93-2925	Copper(II) formate hydrate (544-19-4) Cu(OOCH) ₂ ·XH ₂ O; FW: 153.55; green to blue powder; d. 1.831	10g 50g
93-2927	Copper(II) gluconate, min. 98% (13005-35-1) Cu[OOC(CHOH) ₄ CH ₂ OH] ₂ ; FW: 453.85; blue powder.	100g 500g
29-2928	Copper(II) hexafluoroacetylacetonate, anhydrous, elec. gr. (99.99%-Cu) PURATREM (14781-45-4) Cu(CF ₃ COCHCOF ₃) ₂ ; FW: 477.64; blue xtl. <i>moisture sensitive</i>	1g 5g
93-2929	Copper(II) hexafluoroacetylacetonate hydrate (14781-45-4) Cu(CF ₃ COCHCOF ₃) ₂ ·XH ₂ O; FW: 477.64; green to blue xtl.; m.p. 97-99°; b.p. dec. 220° (subl. 100°/0.5mm)	1g 5g 25g
29-2929	Copper(II) hexafluoroacetylacetonate hydrate, elec. gr. (99.99%-Cu) PURATREM (14781-45-4) Cu(CF ₃ COCHCOF ₃) ₂ ·XH ₂ O; FW: 477.64; green to blue xtl.; m.p. 85-89°; b.p. dec. 220° (subl. 70°/0.05mm) <i>hygroscopic</i>	1g 5g 25g
93-2936	Copper(I) iodide, 98% (7681-65-4) CuI; FW: 190.45; off-white to pale brown powder; m.p. 605°; b.p. 1290°; d. 5.62	100g 500g
29-0485	Copper(I) iodide (99.999%-Cu) PURATREM (7681-65-4) CuI; FW: 190.45; off-white to pale brown powder; m.p. 605°; b.p. 1290°; d. 5.62	10g 50g
29-0490	Copper(I) iodide/cesium carbonate admixture [5.50 wt% CuI] (7681-65-4) CuI/Cs ₂ CO ₃ ; off-white powder.	5g 25g

Technical Note:

- Copper catalyst/base admixture useful for screening reactions involving the N-arylation of nitrogen-containing heterocycles.

Weight-percent of components:

- 5.50 wt% copper(I) iodide
- 94.50 wt% cesium carbonate

References:

- J. Org. Chem.*, **2007**, *72*, 8535

29-0500	Copper(II) methoxide, 99% (1184-54-9) Cu(OCH ₃) ₂ ; FW: 125.61; blue powder. <i>moisture sensitive, (store cold)</i>	5g 25g
29-6750 HAZ	Copper(II) naphthenate, 77% in mineral spirits (8% Cu) (1338-02-9) dark green liq.; f.p. 104°F	250g 1kg
29-7000 HAZ	Copper(II) neodecanoate, superconductor grade, ~60% in toluene (6-12% Cu) (50315-14-5) Cu(OOC ₁₀ H ₁₉) ₂ ; FW: 406.03; dark green liq.	10g 50g
93-2939 HAZ	Copper(II) nitrate trihydrate, 99.5% (10031-43-3) Cu(NO ₃) ₂ ·3H ₂ O; FW: 187.56 (241.60); blue xtl.; m.p. 114.5°; d. 2.32	250g 1kg
93-2940 HAZ	Copper(II) nitrate trihydrate (99.999%-Cu) PURATREM (10031-43-3) Cu(NO ₃) ₂ ·3H ₂ O; FW: 187.56 (241.60); blue xtl.; m.p. 114.5°; d. 2.32	5g 25g 100g
93-2942	Copper(II) oxalate hemihydrate (814-91-5) CuC ₂ O ₄ ·0.5H ₂ O; FW: 151.57 (160.57); blue powder.	25g 100g
93-2944	Copper(I) oxide, min. 95% (1317-39-1) Cu ₂ O; FW: 143.08; red-brown powder; m.p. 1235°; d. 6.0	250g 1kg
93-2981	Copper(I) oxide (99.9%-Cu) (1317-39-1) Cu ₂ O; FW: 143.08; red-brown powder; m.p. 1235°; d. 6.0	25g 100g
93-2943	Copper(II) oxide, min. 97% (99%-Cu) (1317-38-0) CuO; FW: 79.54; black powder; m.p. 1362°; d. 6.3-6.49	100g 500g
29-2945	Copper(II) oxide (99.5%-Cu) (1317-38-0) CuO; FW: 79.54; black powder; m.p. 1362°; d. 6.3-6.49	100g 500g
29-0590	Copper(II) oxide (99.995%-Cu) PURATREM (1317-38-0) CuO; FW: 79.55; 80-100 mesh black powder; m.p. 1362°; d. 6.3-6.49	10g 50g
93-2947 HAZ	Copper(II) perchlorate hexahydrate, 98+% (10294-46-9) Cu(ClO ₄) ₂ ·6H ₂ O; FW: 262.43 (370.53); blue xtl.; m.p. 82°; b.p. 120° dec.; d. 2.225 <i>hygroscopic</i>	25g 100g

COPPER (Compounds)

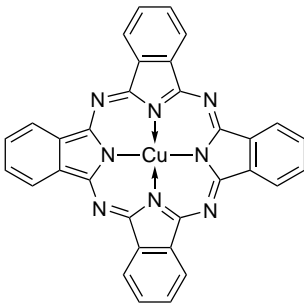
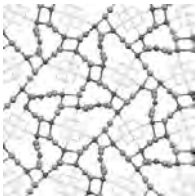
29-0595	Copper(I) phenylacetylide, min. 97% (13146-23-1) C ₆ H ₅ C≡CCu; FW: 164.67; yellow xtl. <i>air sensitive, moisture sensitive</i>	1g 5g
93-2948	Copper(II) phthalocyanine (147-14-8) (C ₃₂ H ₁₆ N ₈)Cu; FW: 576.08; purple powdr.	10g 50g
		
93-2957	Copper(II) sulfate, anhydrous, 98% (7758-98-7) CuSO ₄ ; FW: 159.60; green powdr.; m.p. 200° dec.; d. 3.603 <i>hygroscopic</i>	50g 250g
93-2958	Copper(II) sulfate pentahydrate, 98+% (ACS) (7758-99-8) CuSO ₄ ·5H ₂ O; FW: 159.60 (249.68); blue xtl.; m.p. 110° dec.; d. 2.284	250g 1kg
93-2959	Copper(II) sulfate pentahydrate (99.999%-Cu) PURATREM (7758-99-8) CuSO ₄ ·5H ₂ O; FW: 159.60 (249.68); blue xtl.; m.p. 110° dec.; d. 2.284	5g 25g 100g
93-2960	Copper(I) sulfide (99.5%-Cu) (22205-45-4) Cu ₂ S; FW: 159.14; black powdr.; m.p. 1100°; d. 5.6	50g 250g
29-2969	Copper(II) sulfide (99.5%-Cu) (1317-40-4) CuS; FW: 95.61; -200 mesh black powdr.; d. 4.6	50g 250g
93-2961	Copper(II) tartrate hydrate (815-82-7) CuC ₄ H ₄ O ₆ ·XH ₂ O; FW: 211.61; green to blue xtl.	50g 250g
93-2963	Copper(II) tetrafluoroborate hydrate, 99% (207121-39-9) Cu(BF ₄) ₂ ·XH ₂ O; FW: 237.15; blue xtl.	50g 250g
93-2964	Copper(I) thiocyanate, 99% (1111-67-7) CuSCN; FW: 121.62; off-white powdr.; m.p. 1084°; d. 2.843	50g 250g
93-2966	Copper(II) trifluoroacetylacetonate, 97+% (14324-82-4) Cu(CF ₃ COCHCOCH ₃) ₂ ; FW: 369.70; purple powdr.; m.p. 194-196°; b.p. dec. 260° (subl. 140°/0.1mm)	5g 25g
29-5000 HAZ	Copper(II) trifluoromethanesulfonate, 98% (Copper triflate) (34946-82-2) Cu(CF ₃ SO ₃) ₂ ; FW: 361.68; light green solid <i>hygroscopic</i> For detailed technical note visit strem.com .	5g 25g 100g
29-5500	Cyclopentadienyl(triethylphosphine)copper(I), min. 98% (12261-30-2) (C ₅ H ₅)CuP(C ₂ H ₅) ₃ ; FW: 246.80; white to off-white xtl.; b.p. subl. 60°/0.01mm <i>air sensitive, moisture sensitive</i>	1g 5g
29-0565	(Hexamethylenetetramine)penta[copper(I) cyanide], 98% MOF (1042093-98-0) C ₆ H ₁₂ N ₄ (CuCN) ₅ ; FW: 588.00; white powdr. <i>hygroscopic, (store cold)</i>	500mg 2g
		

Technical Note:

- The copper cyanide hexamethylenetetramine complex is a 3D photoluminescent, very densely-packed, network of tetradentate ligands with a lambda max excitation of 282 and 304nm, and a lambda max emission of 417 and 522nm.

References:

- Inorg. Chem.*, **2007**, 46, 8897
- Inorg. Chem.*, **2008**, 47, 6947
- Inorg. Chim. Acta.*, **2010**, 364, 102
- Dalton Trans.*, **2012**, 41, 11663

COPPER (Compounds)

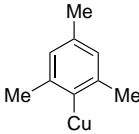
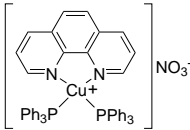
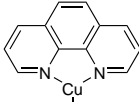
29-5550	Mesitylcopper(I) , min. 95% (75732-01-3) C ₉ H ₁₁ Cu; FW: 182.73; yellow to orange powdr. <i>air sensitive, light sensitive, moisture sensitive, (store cold)</i>		1g 5g
Technical Note: 1. Starting material for a variety of copper(I) complexes.			
29-6000 HAZ	(1,10-Phenanthroline)bis (triphenylphosphine)copper(I) nitrate dichloromethane adduct, 98% (33989-10-5) [Cu(C ₁₂ H ₈ N ₂)[P(C ₆ H ₅) ₃] ₂ ·NO ₃ ⁻ ·1/2CH ₂ Cl ₂ ; FW: 830.33 (872.80); yellow powdr. For detailed technical note visit strem.com .		5g 25g
19-3025	Potassium dicyanocuprate (13682-73-0) See page 341		
29-6600	Tetraamminecopper(II) sulfate hydrate (14283-05-7) [Cu(NH ₃) ₄]SO ₄ ·XH ₂ O; FW: 227.72; blue xtl.		2g 1g 50g
29-6700	Tetrakis(acetonitrile)copper(I) hexafluorophosphate, 98+% (64443-05-6) (CH ₃ CN) ₄ CuPF ₆ ; FW: 372.72; white to light blue solid <i>air sensitive, moisture sensitive</i> For detailed technical note visit strem.com .		5g 25g
29-6720	Trifluoromethyl(1,10-phenanthroline) copper(I), 95% Trifluoromethylator® (1300746-79-5) (C ₁₂ H ₈ N ₂)CuCF ₃ ; FW: 312.76; brown solid <i>air sensitive, moisture sensitive, (store cold)</i> Note: Sold under license from CATYLIX.		250mg 1g 5g 25g

Technical Notes:

1. Reagent used for the perfluoromethylation of arenes and aryl bromides and iodides.
2. Catalyst used in the copper-mediated perfluoroalkylation of heteroaryl bromides.

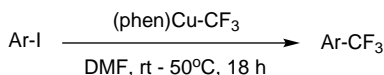

Tech. Note (1)
Ref. (1,2)

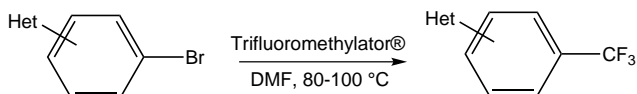

Tech. Note (2)
Ref. (3)

69 examples
up to 99%

References:

1. *Angew. Chem. Int. Ed.*, **2011**, *50*, 3793
2. *Angew. Chem. Int. Ed.*, **2012**, *51*, 536
3. *Org. Lett.*, **2014**, *16*, 1744

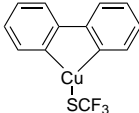
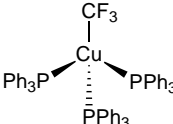
29-5515	Trifluoromethylthiolato(2,2-bipyridine)copper(I), 97% (1413732-47-4) C ₁₁ H ₈ CuF ₃ N ₂ S; FW: 320.80; red xtl. <i>air sensitive, moisture sensitive</i>		250mg 1g
29-2955	Tris(triphenylphosphine)(trifluoromethyl)copper(I), 99% (325810-07-9) C ₅₅ H ₄₅ CuF ₃ P ₃ ; FW: 919.41; white xtl. <i>air sensitive</i> For detailed technical note visit strem.com .		1g 5g

DYSPROSIUM (Elemental Forms)

93-6636 HAZ	Dysprosium chips (99.9% REO) (7429-91-6) Dy; FW: 162.50; (~1mm); m.p. 1409°; b.p. 2335°; d. 8.54 <i>air sensitive</i>	5g 25g
93-6638	Dysprosium foil (99.9% REO) (7429-91-6) Dy; FW: 162.50; 0.25 mm thick (~1.33g/25x 25 mm); m.p. 1409°; b.p. 2335°; d. 8.54 <i>air sensitive</i>	25 x 25mm 50 x 50mm
93-6637	Dysprosium ingot (99.9% REO) (7429-91-6) Dy; FW: 162.50; ingot; m.p. 1409°; b.p. 2335°; d. 8.54 <i>air sensitive</i> For detailed technical note visit strem.com .	25g 100g
93-6635 HAZ	Dysprosium powder (99.9% REO) (7429-91-6) Dy; FW: 162.5; -40 mesh; m.p. 1409°; b.p. 2335°; d. 8.54 <i>air sensitive</i>	5g 25g

DYSPROSIUM (Compounds)

93-6601	Dysprosium(III) acetate hydrate (99.9%-Dy) (REO) (15280-55-4) Dy(OOCCH ₃) ₃ ·XH ₂ O; FW: 339.60; white powdr.; m.p. 120° dec.	25g 100g
66-2002	Dysprosium(III) acetylacetonate hydrate (99.9%-Dy) (REO) (14637-88-8) Dy(CH ₃ COCHCOCH ₃) ₃ ·XH ₂ O; FW: 459.83; yellow powdr.	5g 25g 100g
93-6627	Dysprosium(III) carbonate tetrahydrate (99.9%-Dy) (REO) (38245-35-1) Dy ₂ (CO ₃) ₃ ·4H ₂ O; FW: 505.00 (577.06); white powdr.	25g 100g
93-6607	Dysprosium(III) chloride, anhydrous (99.9%-Dy) (REO) (10025-74-8) DyCl ₃ ; FW: 268.86; white powdr.; m.p. 718°; d. 3.67	2g 10g 50g
93-6628	Dysprosium(III) chloride hexahydrate (99.9%-Dy) (REO) (15059-52-6) DyCl ₃ ·6H ₂ O; FW: 268.86 (376.96); light yellow xtl. <i>hygroscopic</i>	25g 100g
93-6609	Dysprosium(III) fluoride, anhydrous (99.9%-Dy) (REO) (13569-80-7) DyF ₃ ; FW: 219.50; white powdr.; m.p. 1360°; b.p. > 2200° <i>hygroscopic</i>	25g 100g
93-6613 HAZ	Dysprosium(III) nitrate hexahydrate (99.9%-Dy) (REO) (35725-30-5) Dy(NO ₃) ₃ ·6H ₂ O; FW: 348.50 (456.60); yellow xtl. <i>hygroscopic</i>	25g 100g
93-6615	Dysprosium(III) oxide (99.9%-Dy) (REO) (1308-87-8) Dy ₂ O ₃ ; FW: 372.99; white powdr.; m.p. 2330-2350°; d. 7.81	25g 100g
93-6616	Dysprosium(III) oxide (99.998%-Dy) (REO) PURATREM (1308-87-8) Dy ₂ O ₃ ; FW: 372.99; white powdr.; m.p. 2330-2350°; d. 7.81	5g 25g
93-6617 HAZ	Dysprosium(III) perchlorate, 50% aqueous solution (99.9%-Dy) (REO) (14692-17-2) Dy(ClO ₄) ₃ ; FW: 460.85; colorless liq.	10g 50g
93-6619 HAZ	Dysprosium(III) i-propoxide (99.9%-Dy) (REO) (6742-68-3) Dy(OC ₃ H ₇) ₃ ; FW: 339.77; tan powdr. <i>moisture sensitive</i>	1g 5g
66-4000	Dysprosium(III) trifluoromethanesulfonate, min. 98% (Dysprosium triflate) (139177-62-1) Dy(CF ₃ SO ₃) ₃ ; FW: 609.71; white solid <i>hygroscopic</i>	5g 25g
66-3000 amp	Tris(i-propylcyclopentadienyl)dysprosium(III) (99.9%-Dy) (REO) (952518-08-0) (C ₅ H ₇ C ₅ H ₅) ₃ Dy; FW: 484.02; yellow solid <i>air sensitive, moisture sensitive</i>	1g 5g
66-8500	Tris(2,2,6,6-tetramethyl-3,5-heptanedionato)dysprosium(III), 98+% (99.9%-Dy) (REO) [Dy(TMHD)₃] (15522-69-7) Dy(C ₁₁ H ₁₉ O ₂) ₃ ; FW: 712.31; off-white xtl.; m.p. 182-185°; b.p. dec. 265° <i>hygroscopic</i>	1g 5g

ERBIUM (Elemental Forms)

93-6831	Erbium chips (99.9% REO) (7440-52-0) Er; FW: 167.28; m.p. 1529°; b.p. 2863°; d. 9.006 <i>air sensitive</i>	5g 25g
---------	---	-----------

ERBIUM (Elemental Forms)

93-6834	Erbium foil (99.9% REO) (7440-52-0) Er; FW: 167.28; 0.62 mm thick (~3.5g/25 x 25 mm); m.p. 1529°; b.p. 2863°; d. 9.006 <i>air sensitive</i>	25 x 25mm 50 x 50mm
93-6833	Erbium foil (99.9% REO) (7440-52-0) Er; FW: 167.28; 0.25 mm thick (~1.4g/25 x 25 mm); m.p. 1529°; b.p. 2863°; d. 9.006 <i>air sensitive</i>	25 x 25mm
93-6832	Erbium ingot (99.9% REO) (7440-52-0) Er; FW: 167.28; ingot; m.p. 1529°; b.p. 2863°; d. 9.006 <i>air sensitive</i> For detailed technical note visit strem.com .	10g 50g
93-6830 HAZ	Erbium powder (99.9% REO) (7440-52-0) Er; FW: 167.28; -40 mesh; m.p. 1529°; b.p. 2863°; d. 9.006 <i>air sensitive</i>	5g 25g

ERBIUM (Compounds)

93-6824	Erbium(III) acetate hydrate (99.9%-Er) (REO) (15280-57-6) Er(OOCC ₃ H ₇) ₃ ·XH ₂ O; FW: 344.44; pink xtl.; d. 2.114	10g 50g
93-6801	Erbium(III) acetylacetonate hydrate (99.9%-Er) (REO) (14553-08-3) Er(CH ₃ COCHCOCH ₃) ₃ ·XH ₂ O; FW: 464.59; off-white powdr.	5g 25g
93-6822	Erbium(III) carbonate hydrate (99.9%-Er) (REO) (22992-83-2) Er ₂ (CO ₃) ₃ ·XH ₂ O; FW: 514.54; pink powdr.	10g 50g
93-6803	Erbium(III) chloride, anhydrous (99.9%-Er) (REO) (10138-41-7) ErCl ₃ ; FW: 273.64; pink powdr.; m.p. 774°; b.p. 1500° <i>hygroscopic</i>	5g 25g
93-6804	Erbium(III) chloride hydrate (99.9%-Er) (REO) (10025-75-9) ErCl ₃ ·XH ₂ O; FW: 273.64; pink xtl. <i>hygroscopic</i>	25g 100g
68-6804	Erbium(III) chloride hydrate (99.999%-Er) (REO) PURATREM (10025-75-9) ErCl ₃ ·XH ₂ O; FW: 273.64; pink xtl. <i>hygroscopic</i>	10g 50g
68-6805	Erbium(III) chloride hydrate (99.999+%-Er) (low Ca, Fe, Mg) PURATREM (10025-75-9) ErCl ₃ ·XH ₂ O; FW: 273.64; pink xtl. <i>hygroscopic</i>	10g 50g
68-6900	Erbium(III) hexafluoroacetylacetonate hydrate (99.9%-Er) (REO) (18923-92-7) Er(CF ₃ COCHCOCF ₃) ₃ ·XH ₂ O; FW: 788.45; pink xtl.	1g 5g
93-6823	Erbium(III) iodide, anhydrous (99.9%-Er) (REO) (13813-42-8) ErI ₃ ; FW: 547.99; red powdr.; m.p. 1020°; b.p. 1280° <i>hygroscopic</i>	1g 5g
93-6808 HAZ	Erbium(III) nitrate hydrate (99.9%-Er) (REO) (10031-51-3) Er(NO ₃) ₃ ·XH ₂ O; FW: 353.29; pink xtl. <i>hygroscopic</i>	25g 100g
93-6810	Erbium(III) oxide (99.9%-Er) (REO) (12061-16-4) Er ₂ O ₃ ; FW: 382.51; rose powdr.; m.p. 2400°; d. 8.640	5g 25g 100g
93-6820	Erbium(III) oxide (99.995%-Er) (REO) PURATREM (12061-16-4) Er ₂ O ₃ ; FW: 382.51; rose powdr.; m.p. 2400°; d. 8.640	5g 25g
93-6821 HAZ	Erbium(III) perchlorate, 50% aqueous solution (99.9%-Er) (REO) (61565-07-9) Er(ClO ₄) ₃ ; FW: 465.61; rose colored liq.	2g 10g
68-5000 amp HAZ	Erbium(III) i-propoxide (99.9%-Er) (REO) (14814-07-4) Er(OC ₃ H ₇) ₃ ; FW: 344.52; pink powdr. <i>moisture sensitive</i>	1g 5g
68-6000	Erbium(III) trifluoromethanesulfonate, min. 98% (Erbium triflate) (139177-64-3) Er(CF ₃ SO ₃) ₃ ; FW: 614.47; pink powdr. <i>hygroscopic</i>	5g 25g
68-7000 amp	Tris(n-butylcyclopentadienyl)erbium(III) (99.9%-Er) (REO) (153608-51-6) (C ₄ H ₉ C ₅ H ₅) ₃ Er; FW: 530.87; yellow to orange liq.; b.p. 240°/0.1mm; d. 1.309 <i>air sensitive, moisture sensitive</i>	1g 5g

ERBIUM (Compounds)

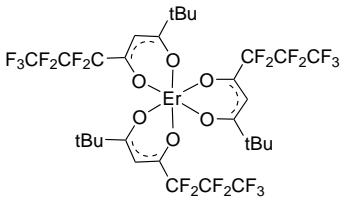
68-8000 amp HAZ	Tris(cyclopentadienyl)erbium(III) (99.9%-Er) (REO) (39330-74-0) (C ₅ H ₅) ₃ Er; FW: 362.55; pink powdr.; m.p. 285°; b.p. subl. 200°/0.01mm <i>air sensitive, moisture sensitive</i>	1g 5g
68-8700	Tris(6,6,7,7,8,8,8-heptafluoro-2,2-dimethyl-3, 5-octanedionate)erbium(III) (99.9%-Er) (REO) [Er(FOD)₃] (17978-75-5) Er(C ₃ F ₇ COCHCOOC ₄ H ₉) ₃ ; FW: 1052.80; pink powdr.; m.p. 157-163°	1g 5g
		
68-8740 amp	Tris(methylcyclopentadienyl)erbium(III) (99.9%-Er) (REO) (39470-10-5) (CH ₃ C ₅ H ₄) ₃ Er; FW: 404.62; yellow powdr. <i>air sensitive</i>	1g 5g
68-7200 amp	Tris(i-propylcyclopentadienyl)erbium(III) (99.9%-Er) (REO) (130521-76-5) (C ₃ H ₇ C ₅ H ₄) ₃ Er; FW: 488.79; yellow to orange xtl.; m.p. 222° (subl.); b.p. subl. 222°/10mm <i>air sensitive, moisture sensitive</i>	1g 5g
68-8750	Tris(2,2,6,6-tetramethyl-3,5-heptanedionato)erbium(III), 99% (99.9%-Er) (REO) [Er(TMHD)₃] (35733-23-4) Er(C ₁₁ H ₁₉ O ₂) ₃ ; FW: 717.08; pink xtl.; m.p. 179-180°; b.p. dec. 345° (subl. 160°/0.1mm)	1g 5g 25g

EUROPIUM (Elemental Forms)

93-6335 HAZ	Europium ingot (99.9% REO) (7440-53-1) Eu (under oil); FW: 151.96; packed in mineral oil; m.p. 822°; d. 5.24 <i>air sensitive, moisture sensitive</i> For detailed technical note visit strem.com .	1g 5g
----------------	--	----------

EUROPIUM (Compounds)

93-6301	Europium(III) acetate hydrate (99.9%-Eu) (REO) (62667-64-5) Eu(OOCCH ₃) ₃ ·XH ₂ O; FW: 329.10; white xtl.	1g 5g
93-6304	Europium(III) carbonate hydrate (99.9%-Eu) (REO) (5895-48-7) Eu ₂ (CO ₃) ₃ ·XH ₂ O; FW: 483.95; white powdr.	1g 5g
93-6305	Europium(III) chloride, anhydrous (99.9%-Eu) (REO) (10025-76-0) EuCl ₃ ; FW: 258.32; white to yellow powdr.; m.p. 850°; d. 4.89 <i>hygroscopic</i>	2g 10g
93-6306	Europium(III) chloride hexahydrate (99.9%-Eu) (REO) (13759-92-7) EuCl ₃ ·6H ₂ O; FW: 258.32 (366.41); white to off-white xtl. <i>hygroscopic</i>	5g 25g
93-6311	Europium(III) 2-ethylhexanoate (99.9%-Eu) (REO) (84573-73-9) Eu[OOCCH(C ₂ H ₅)C ₄ H ₉] ₃ ; FW: 581.58; white powdr.	1g 5g
93-6322	Europium(III) fluoride, anhydrous (99.99%-Eu) (REO) PURATREM (13765-25-8) EuF ₃ ; FW: 208.96; white powdr.; m.p. 1390°; b.p. 2280° <i>hygroscopic</i>	1g 5g
93-6310 HAZ	Europium(III) nitrate hexahydrate (99.9%-Eu) (REO) (10031-53-5) Eu(NO ₃) ₃ ·6H ₂ O; FW: 337.98 (446.07); white xtl. <i>hygroscopic</i>	1g 5g 25g
63-1200	Europium nitride (99.9%-Eu) (12020-58-5) EuN; FW: 165.97; 60 mesh black powdr.	100mg 500mg
93-6325	Europium(III) oxalate hydrate (99.9%-Eu) (REO) (14175-02-1) Eu ₂ (C ₂ O ₄) ₃ ·XH ₂ O; FW: 567.99; white powdr.	2g 10g
93-6312	Europium(III) oxide (99.99%-Eu) (REO) PURATREM (1308-96-9) Eu ₂ O ₃ ; FW: 351.92; white powdr.; d. 7.42	5g 25g 100g
93-6323 HAZ	Europium(III) perchlorate, 50% aqueous solution (99.9%-Eu) (REO) (36907-40-1) Eu(ClO ₄) ₃ ; FW: 450.31; colorless liq.	2g 10g
93-6324	Europium(III) sulfate octahydrate (99.9%-Eu) (REO) (10031-55-7) Eu ₂ (SO ₄) ₃ ·8H ₂ O; FW: 592.11 (736.23); white xtl.	1g 5g

EUROPIUM (Compounds)

93-6330	Europium(III) sulfate octahydrate (99.99%-Eu) (REO) PURATREM (10031-55-7) Eu ₂ (SO ₄) ₃ ·8H ₂ O; FW: 592.11 (736.23); white xtl.	1g 5g
63-1000	Europium(III) trifluoromethanesulfonate, min. 98% (Europium triflate) (52093-25-1) Eu(CF ₃ SO ₃) ₃ ; FW: 599.17; white to off-white powdr. <i>hygroscopic</i>	1g 5g
93-6326	Tris(6,6,7,7,8,8,8-heptafluoro-2,2-dimethyl-3,5-octanedionate)europium(III) hydrate (99.9%-Eu) (REO) [Eu(FOD)₃] (13537-22-9) Eu(C ₃ F ₇ COCHCOC ₂ H ₉) ₃ ·XH ₂ O; FW: 1037.49; white to light-yellow powdr.	1g 5g
93-6328	Tris(2,2,6,6-tetramethyl-3,5-heptanedionate)europium(III), 99% (99.9%-Eu) (REO) [Eu(TMHD)₃] (15522-71-1) Eu(C ₁₁ H ₁₉ O ₂) ₃ ; FW: 701.78; yellow powdr.; m.p. 188-189°; b.p. dec. 275°	1g 5g

FLUORINE (Compounds)

09-1070	5-Amino-2-chlorobenzotrifluoride, min. 97% (320-51-4) (NH ₂)CIC ₆ H ₃ CF ₃ ; FW: 195.56; brown waxy solid; m.p. 36-37°; f.p. >230°F	5g 25g
09-1210	Benzoyl-1,1,1-trifluoroacetone, 98% (326-06-7) C ₆ H ₅ COCH ₂ COCF ₃ ; FW: 216.02; white xtl.; m.p. 38-40°; b.p. 224°	10g 50g
09-1520	Bromopentafluorobenzene, 99% (344-04-7) C ₆ F ₅ Br; FW: 246.97; colorless liq.; m.p. -31°; b.p. 137°; f.p. 190°F; d. 1.981	10g 50g
09-1600	3-Bromo-1,1,1-trifluoroacetone, min. 97% (431-35-6) HAZ CF ₃ COCH ₂ Br; FW: 191.02; colorless liq.; b.p. 85-87°; d. 1.839	5g 25g
09-1722	2-Chloro-1,2-dibromo-1,1,2-trifluoroethane, min. 97% (354-51-8) CF ₂ BrCFClBr; FW: 276.29; colorless liq.; b.p. 93-94°; d. 2.2478	25g
09-1863	3-Chloro-4-fluorobenzotrifluoride, 98% (78068-85-6) ClFC ₆ H ₃ CF ₃ ; FW: 198.55; liq.; d. 1.490	10g 50g
09-1881	2-Chloro-5-fluorophenol, min. 97% (3827-49-4) ClFC ₆ H ₃ OH; FW: 146.54; liq.; b.p. 183-185°	5g 25g
09-2010	Chloropentafluorobenzene, 99% (344-07-0) ClC ₆ F ₅ ; FW: 202.51; colorless liq.; b.p. 122-123°/750mm; d. 1.568	25g 100g
09-2360	1,1-Dichloro-2,2-difluoroethylene, min. 97% (79-35-6) HAZ CCl ₂ =CF ₂ ; FW: 133.00; colorless liq.; m.p. -116°; b.p. 19°; d. 1.439	25g 100g
		
93-1571	Difluorophosphoric acid hemihydrate, tech. gr. (13779-41-4) See page 297	
09-3270	Ethyltrifluoroacetate, 99% (383-63-1) HAZ CF ₃ CO ₂ C ₂ H ₅ ; FW: 142.08; colorless liq.; b.p. 62°; f.p. 30°F; d. 1.194	25g 100g 500g
09-3480	Fluorobenzene, 99% (462-06-6) HAZ C ₆ H ₅ F; FW: 96.10; colorless liq.; m.p. -42°; b.p. 84-85°; f.p. 9°F; d. 1.024	25g 100g 500g
09-3500	o-Fluorobenzoic acid, min. 97% (445-29-4) FC ₆ H ₄ COOH; FW: 140.11; white powdr.; m.p. 123-125°	25g 100g
09-3890	o-Fluoronitrobenzene (1493-27-2) FC ₆ H ₄ NO ₂ ; FW: 141.10; colorless liq.; m.p. -8°; b.p. 214-216°; f.p. 202°F; d. 1.338	10g 50g
09-4070	o-Fluorophenol, min. 98% (367-12-4) HAZ FC ₆ H ₄ OH; FW: 112.10; colorless liq.; m.p. 16.1°; b.p. 171-172°/741 mm; f.p. 116°F; d. 1.256	10g 50g
09-4090	p-Fluorophenol, 99% (371-41-5) FC ₆ H ₄ OH; FW: 112.10; off-white flakes; m.p. 48-51°; b.p. 185°; f.p. 155°F	25g 100g
93-1529	Fluorophosphoric acid, 60-70% (13537-32-1) See page 313	
09-4310	o-Fluorotoluene, 99% (95-52-3) HAZ FC ₆ H ₄ CH ₃ ; FW: 110.13; colorless liq.; m.p. -62°; b.p. 113-115°; f.p. 55°F; d. 1.001	50g 250g
09-4396	2,2,3,3,4,4,4-Heptafluorobutylamine, min. 97% (374-99-2) CF ₃ CF ₂ CF ₂ CH ₂ NH ₂ ; FW: 197.05; colorless liq.; b.p. 70-71°; d. 1.493	1g 5g

FLUORINE (Compounds)

09-4496 HAZ	6,6,7,7,8,8,8-Heptafluoro-2,2-dimethyl-3,5-octanedione, 98+% HFOD (17587-22-3) $C_8F_7C(O)CH_2C(O)C(CH_3)_3$; FW: 296.19; colorless to pale yellow liq.; b.p. 56-57°/10 mm; f.p. 101°F; d. 1.273	5g 25g
09-4530	1H,1H,9H-Hexadecafluoro-1-nonanol, 95% (376-18-1) $HCF_2(CF_2)_7CH_2OH$; FW: 432.10; waxy flakes	10g 50g
09-4568 HAZ 	Hexafluoroacetone, anhydrous, 97% (684-16-2) CF_3COCF_3 ; FW: 166.02; gas; b.p. -28° For detailed technical note visit strem.com .	25g
09-4571 HAZ	Hexafluoroacetone trihydrate, min. 97% (34202-69-2) $CF_3COCF_3 \cdot 3H_2O$; FW: 166.02 (220.07); colorless liq.; m.p. 18-21°; d. 1.579	5g 25g
08-0750 HAZ	Hexafluoroacetylacetone, min. 98% HFAA (1522-22-1) $CF_3C(O)CH_2C(O)CF_3$; FW: 208.06; colorless liq.; b.p. 70°; d. 1.470 <i>moisture sensitive</i>	5g 25g 100g
09-4630 amp HAZ	Hexafluorobenzene, min. 99% (392-56-3) C_6F_6 ; FW: 186.05; colorless liq.; m.p. 4°; b.p. 81-82°; f.p. 50°F; d. 1.612	5g 25g
09-4700	Hexafluoroglutaric acid, min. 97% (376-73-8) $HO_2C(CF_2)_3CO_2H$; FW: 240.06; off-white lumps; m.p. 92-97°; b.p. 134-138°/3 mm <i>hygroscopic</i>	5g 25g
09-4750 HAZ	Hexafluoroisopropanol, 99+% (920-66-1) $(CF_3)_2CHOH$; FW: 168.04; colorless liq.; m.p. -4°; b.p. 58°; d. 1.596	5g 25g
09-4765	Hexafluoro-2-methylisopropanol, min. 97% (1515-14-6) $(CF_3)_2C(CH_3)OH$; FW: 182.07; pale yellow liq.; b.p. 60°; d. 1.484	5g 25g
93-1531	Hexafluorophosphoric acid, 60-70% in water (16940-81-1) See page 313	
93-2230	Hexafluorotitanic acid, 60% aqueous solution (17439-11-1) See page 440	
09-4950	Iodopentafluorobenzene, 97% (827-15-6) C_6F_5I ; FW: 293.96; colorless liq.; b.p. 161°; d. 2.204	5g 25g
09-5350	1H,1H,5H-Octafluoro-1-pentanol, min. 98% (355-80-6) $H(CF_2)_4CH_2OH$; FW: 232.07; colorless liq.; b.p. 140-141°; f.p. 168°F; d. 1.667	25g 100g
09-5380	Pentadecafluorooctanoic acid, min. 98% (335-67-1) $n-C_{17}F_{15}COOH$; FW: 414.06; white pwdr.; m.p. 59-60°; b.p. 189°/736 mm	5g 25g
09-5420	Pentafluoroaniline, 99% (771-60-8) $C_6F_5NH_2$; FW: 183.08; white pwdr.; m.p. 34°; b.p. 153°; f.p. 165°F	5g 25g
09-5440	Pentafluorobenzaldehyde, 98% (653-37-2) C_6F_5CHO ; FW: 196.07; colorless to pale yellow solid; m.p. 20°; b.p. 164-166°; d. 1.588	1g 5g 25g
09-5450 amp HAZ	Pentafluorobenzene, 99% (363-72-4) C_6F_5H ; FW: 168.06; colorless liq.; m.p. -48°; b.p. 85°; f.p. 57°F; d. 1.514	5g 25g
09-5500	Pentafluorobenzoic acid, 99% (602-94-8) C_6F_5COOH ; FW: 212.07; white xtl.; m.p. 103°; b.p. 220°	1g 5g 25g
09-5550 HAZ	Pentafluorobenzylbromide, 98+% (1765-40-8) $C_6F_5CH_2Br$; FW: 260.99; colorless liq.; b.p. 174-175°; f.p. 181°F; d. 1.728	1g 5g 25g
09-5600 HAZ	Pentafluoroethyl iodide, min. 97% (354-64-3) C_2F_5I ; FW: 245.93; gas; b.p. 12-13°	25g 100g
09-5630	Pentafluorophenol, 99% (771-61-9) C_6F_5OH ; FW: 184.06; colorless solid; m.p. 26-29°; b.p. 143°; f.p. 162°F	5g 25g
09-5740 HAZ	Pentafluoropropionic acid, min. 97% (422-64-0) C_2F_5COOH ; FW: 164.03; colorless liq.; b.p. 96-98°; d. 1.561 <i>hygroscopic</i>	10g 50g

FLUORINE (Compounds)

09-5750 HAZ	Pentafluoropropionic anhydride, min. 97% (356-42-3) $(C_2F_5CO)_2O$; FW: 310.05; colorless liq.; b.p. 73-74°; d. 1.571 <i>moisture sensitive</i>	5g 25g
09-5800 amp HAZ	Pentafluoropyridine, 99% (700-16-3) C_5F_5N ; FW: 169.05; colorless liq.; b.p. 83-85°; f.p. 75°F; d. 1.540	5g 25g
09-5820 HAZ	Pentafluorothiophenol, 97% (771-62-0) C_6F_5SH ; FW: 200.13; colorless liq.; m.p. -24°; b.p. 143°; f.p. 125°F; d. 1.501 <i>STENCH</i>	5g 25g
09-5902	Perfluoro-t-butanol, min. 97% (2378-02-1) $(CF)_3C(OH)$; FW: 236.05; colorless liq.; b.p. 44-45°; d. 1.693	5g
09-5910	Perfluoro-2-butyltetrahydrofuran, min. 95% (335-36-4) $C_8F_{16}O$; FW: 416.09; colorless liq.; b.p. 99-107°; d. 1.77	25g 100g
09-5960 HAZ	Perfluorodecalin, min. 95% (306-94-5) $C_{10}F_{18}$; FW: 462.07; colorless liq.; m.p. -10°; b.p. 141°; f.p. 105°F; d. 1.908	5g 25g
09-5969	1H,1H,2H,2H-Perfluorodecan-1-ol, min. 97% (678-39-7) $CF_3(CF_2)_7CH_2CH_2OH$; FW: 464.12; tan waxy solid; m.p. 40-43°	25g 100g
09-5972	1H,1H,2H,2H-Perfluorodecyl iodide, 97% (2043-53-0) $C_8F_{17}CH_2CH_2I$; FW: 573.91; white solid; b.p. 178-180°	5g 25g
09-6034 HAZ	Perfluoroheptanoic acid, min. 97% (375-85-9) $C_6F_{13}COOH$; FW: 383.06; colorless liq. to waxy solid; b.p. 78-80°/14 mm	5g 25g
09-6072	Perfluorohexane, 98+% (85% n-isomer) (355-42-0) C_6F_{14} ; FW: 338.04; colorless liq.; b.p. 57°; d. 1.669	10g 50g 250g
09-6085	1H,1H,2H,2H-Perfluorohexan-1-ol, 99% (2043-47-2) $F(CF_2)_4CH_2CH_2OH$; FW: 264.09; colorless liq.; b.p. 140-143°; d. 1.59	10g
09-6147	1H,1H,2H,2H-Perfluorooctan-1-ol, min. 97% (647-42-7) $F(CF_2CF_2)_3CH_2CH_2OH$; FW: 364.10; colorless liq.; b.p. 91-93°/36 mm; d. 1.651	5g 25g
09-6146 HAZ	Perfluorooctanesulfonyl fluoride, min. 95% (307-35-7) $CF_3(CF_2)_7SO_2F$; FW: 502.12; colorless to yellow liq.; m.p. -18° to -30°; b.p. 154°; d. 1.81 <i>moisture sensitive</i>	25g 100g
09-6144	Perfluorooctanesulphonic acid, potassium salt, 97% (2795-39-3) $C_8F_{17}SO_3K$; FW: 538.21; white powdr.	5g 25g
93-1010	Perfluorooctanoic acid, sodium salt (335-95-5) $NaOOC(CF_2)_6CF_3$; FW: 436.05; off-white powdr.	5g 25g
09-6182	Perfluoro-n-pentane, min. 98% (678-26-2) C_5F_{12} ; FW: 288.03; colorless liq.; m.p. -120°; b.p. 29°; d. 1.63*0.06@25°C <i>(store cold)</i>	50g 250g
09-5950	Perfluorotetradecanoic acid, min. 97% (376-06-7) See page 168	
09-6220 HAZ	Perfluorotri-n-butylamine, min. 85% (311-89-7) $(C_4F_9)_3N$; FW: 671.02; colorless liq.; b.p. 170-180°; d. 1.88	25g 100g
09-6920 HAZ	2,3,5,6-Tetrafluorothiophenol, min. 98% (769-40-4) HC_6F_4SH ; FW: 182.14; colorless liq.; b.p. 152-153°; f.p. 119°F <i>STENCH</i>	5g 25g
09-6950	2-Thenoyltrifluoroacetone, 99% (TTA) (326-91-0) $CF_3COCH_2COC_4H_9S$; FW: 222.18; white powdr.; m.p. 42-43°; b.p. 96-98°/8 mm	25g 100g
09-7170 HAZ	Trifluoroacetic anhydride, min. 98% (407-25-0) $(CF_3CO)_2O$; FW: 210.03; colorless liq.; m.p. -65°; b.p. 39-40°; d. 1.487 <i>moisture sensitive</i>	50g 250g
09-7160 HAZ	Trifluoroacetic acid, 99% (76-05-1) CF_3COOH ; FW: 114.02; colorless liq.; m.p. -15.4°; b.p. 74°; d. 1.480	100g 500g
09-7210 HAZ	1,1,1-Trifluoroacetylacetone, min. 98% (367-57-7) $CF_3COCH_2COCH_3$; FW: 154.09; colorless liq.; b.p. 107°; f.p. 79°F; d. 1.270	10g 50g
09-7304 HAZ	2,2,2-Trifluoroethanesulphonylchloride, 97+% (1648-99-3) $CF_3CH_2SO_2Cl$; FW: 182.55; colorless liq.; b.p. 140-141°; f.p. 162°F; d. 1.651 <i>moisture sensitive</i>	250mg 1g 5g

FLUORINE (Compounds)

09-7310 HAZ	2,2,2-Trifluoroethanol, 99% (75-89-8) CF ₃ CH ₂ OH; FW: 100.04; colorless liq.; m.p. -44°; b.p. 74-75°; f.p. 85°F; d. 1.373	50g 250g
09-7370	2,2,2-Trifluoroethyl iodide, 99% (353-83-3) CF ₃ CH ₂ I; FW: 209.94; colorless liq.; b.p. 55-56°; d. 2.130	5g 25g
09-7410 amp HAZ	Trifluoromethanesulfonic acid, 99+% (1493-13-6) CF ₃ SO ₃ H; FW: 150.07; colorless fuming liq.; b.p. 162°; d. 1.696 <i>hygroscopic</i>	10g 50g
09-7420 amp HAZ	Trifluoromethanesulphonic anhydride, min. 97% (358-23-6) (CF ₃ SO ₂) ₂ O; FW: 282.13; colorless liq.; b.p. 81-83°; d. 1.677 <i>moisture sensitive</i>	5g 25g
09-7502	p-Trifluoromethylbenzaldehyde, 98+% (455-19-6) CF ₃ C ₆ H ₄ CHO; FW: 174.12; colorless liq.; b.p. 80-81°/25 mm; f.p. 150°F; d. 1.275	5g 25g
09-7680 HAZ	Trifluoromethyl iodide, min. 97% (2314-97-8) CF ₃ I; FW: 195.9; gas; b.p. -22°	100g
09-7731 HAZ	p-Trifluoromethylphenylisocyanate, 99% (1548-13-6) CF ₃ C ₆ H ₄ NCO; FW: 187.12; colorless liq.; b.p. 58-59°/10 mm; f.p. 158°F; d. 1.310 <i>moisture sensitive</i>	1g 5g
09-7760 HAZ	2-Trifluoromethylpropene, min. 97% (374-00-5) CH ₃ C(CF ₃)=CH ₂ ; FW: 110.08; gas; b.p. 6-7°	10g
14-7990	Trifluoromethyltrimethylsilane, min. 97% (81290-20-2) See page 411	

GADOLINIUM (Elemental Forms)

93-6431	Gadolinium chips (99.9% REO) (7440-54-2) Gd; FW: 157.25; gray pieces; m.p. 1311°; b.p. 3233°; d. 7.898 <i>air sensitive</i>	5g 25g
93-6435	Gadolinium foil (99.9% REO) (7440-54-2) Gd; FW: 157.25; 0.62 mm thick (~3.06g/25x 25 mm); m.p. 1311°; b.p. 3233°; d. 7.898 <i>air sensitive</i>	25 x 25mm 50 x 50mm
93-6434	Gadolinium foil (99.9% REO) (7440-54-2) Gd; FW: 157.25; 0.25 mm thick (~1.23g/25x 25 mm); m.p. 1311°; b.p. 3233°; d. 7.898 <i>air sensitive</i>	25 x 25mm 50 x 50mm
93-6433	Gadolinium foil (99.9% REO) (7440-54-2) Gd; FW: 157.25; 0.127 mm thick (~0.63g/25 x 25mm); m.p. 1311°; b.p. 3233°; d. 7.898 <i>air sensitive</i>	25 x 25mm 50 x 50mm
93-6432	Gadolinium ingot (99.9% REO) (7440-54-2) Gd; FW: 157.25; ingot; m.p. 1311°; b.p. 3233°; d. 7.898 <i>air sensitive</i> For detailed technical note visit strem.com .	10g 50g
93-6430 HAZ	Gadolinium powder (99.9% REO) (7440-54-2) Gd; FW: 157.25; -40 mesh; m.p. 1311°; b.p. 3233°; d. 7.898 <i>air sensitive</i>	5g 25g

GADOLINIUM (Compounds)

93-6424	Gadolinium(III) acetate tetrahydrate (99.9%-Gd) (REO) (15280-53-2) Gd(OOCCH ₃) ₃ ·4H ₂ O; FW: 334.38 (406.45); white xtl.; d. 1.611	25g 100g
93-6401	Gadolinium(III) acetylacetonate hydrate (99.9%-Gd) (REO) (14284-87-8) Gd(CH ₃ COCHCOCH ₃) ₃ ·XH ₂ O; FW: 454.58; off-white powdr.	5g 25g
64-3000	Gadolinium(III) carbonate hydrate (99.99%-Gd) (REO) PURATREM (38245-36-2) Gd ₂ (CO ₃) ₃ ·XH ₂ O; FW: 494.53; white powdr.	10g 50g
93-6416	Gadolinium(III) chloride, anhydrous (99.9%-Gd) (REO) (10138-52-0) GdCl ₃ ; FW: 263.61; white powdr.; m.p. 609°; d. 4.52 <i>hygroscopic</i>	10g 50g
93-6421	Gadolinium(III) chloride hydrate (99.9%-Gd) (REO) (19423-81-5) GdCl ₃ ·XH ₂ O; FW: 263.61; white powdr.; d. 2.424	25g 100g

GADOLINIUM (Compounds)

64-3500 HAZ	Gadolinium(III) 2-ethylhexanoate (~25% in toluene) (19189-19-6) Gd[OOCCH(C ₂ H ₅)C ₄ H ₉] ₃ ; FW: 586.87; viscous liq.	10g 50g
93-6422	Gadolinium(III) fluoride, anhydrous (99.9%-Gd) (REO) (13765-26-9) GdF ₃ ; FW: 214.25; white powdr.	10g 50g
64-3600	Gadolinium(III) hydroxide hydrate (99.9%-Gd) (REO) (16469-18-4) Gd(OH) ₃ ·XH ₂ O; FW: 208.27; white powdr.	10g 50g
93-6417 HAZ	Gadolinium(III) nitrate hexahydrate (99.9%-Gd) (REO) (19598-90-4) Gd(NO ₃) ₃ ·6H ₂ O; FW: 343.27 (451.36); white xtl. <i>hygroscopic</i>	25g 100g
93-6406	Gadolinium(III) oxide (99.99%-Gd) (REO) PURATREM (12064-62-9) Gd ₂ O ₃ ; FW: 362.50; white powdr.; m.p. 2310°; d. 7.407	100g 500g
93-6420 HAZ	Gadolinium(III) perchlorate, 40-50% aqueous solution (99.9%-Gd) (REO) (14017-52-8) Gd(ClO ₄) ₃ ; FW: 455.60; colorless liq.	10g 50g
64-3700	Gadolinium(III) i-propoxide (99.9%-Gd) (REO) (14532-05-9) Gd(OC ₃ H ₇) ₃ ; FW: 334.51; white to off-white powdr. <i>moisture sensitive</i>	1g 5g
93-6407	Gadolinium(III) sulfate octahydrate (99.9%-Gd) (REO) (13450-87-8) Gd ₂ (SO ₄) ₃ ·8H ₂ O; FW: 602.68 (746.81); white xtl.; d. 3.010	25g 100g
64-3800	Gadolinium(III) trifluoromethanesulfonate, min. 98% (Gadolinium triflate) (52093-29-5) Gd(CF ₃ SO ₃) ₃ ; FW: 604.46; white powdr. <i>hygroscopic</i>	5g 25g
64-4000 amp HAZ	Tris(cyclopentadienyl)gadolinium(III) (99.9%-Gd) (REO) (1272-21-5) (C ₅ H ₅) ₃ Gd; FW: 352.54; off-white powdr. <i>air sensitive, moisture sensitive</i>	1g 5g
64-4500 amp HAZ	Tris(tetramethylcyclopentadienyl)gadolinium(III), min. 98% (308847-85-0) [(CH ₃) ₄ C ₅ H ₃] ₃ Gd; FW: 520.86; orange powdr. <i>air sensitive, moisture sensitive</i>	1g 5g
64-5000	Tris(2,2,6,6-tetramethyl-3,5-heptanedionato) gadolinium(III), 99% (99.9%-Gd) (REO) [Gd(TMHD)₃] (14768-15-1) Gd(C ₁₁ H ₁₉ O ₂) ₃ ; FW: 707.07; off-white xtl.; m.p. 178-183°; b.p. dec. 295°	1g 5g







GALLIUM (Elemental Forms)

93-3145 HAZ	Gallium metal (99.99%) (7440-55-3) Ga; FW: 69.72; m.p. 29.78°; b.p. 2403°; d. 5.904 <i>air sensitive, moisture sensitive</i>	10g 50g
93-3146 HAZ	Gallium metal (99.9999%) (7440-55-3) Ga; FW: 69.72; m.p. 29.78°; b.p. 2403°; d. 5.904 <i>air sensitive, moisture sensitive</i>	10g 50g

GALLIUM (Compounds)

31-2030 amp HAZ	Bis(μ-dimethylamino)tetrakis (dimethylamino) digallium, 98% (57731-40-5) C ₁₂ H ₃₆ Ga ₂ N ₆ ; FW: 403.90; white xtl. <i>moisture sensitive</i>	1g 5g 25g
93-3130	Gallium(III) acetylacetonate (99.99%-Ga) PURATREM (14405-43-7) Ga(CH ₃ COCHCOCH ₃) ₃ ; FW: 367.05; white to pale yellow powdr.; m.p. 192-194° dec. >280°; b.p. 140°/10 mm subl.; d. 1.42	5g 25g
93-3103 HAZ	Gallium arsenide (99.9999%-Ga) PURATREM (1303-00-0) GaAs; FW: 144.64; 25mm and down polycrystalline pieces; m.p. 1238°; d. 5.31	1g 5g
93-3109 HAZ	Gallium(III) bromide, anhydrous, granular (99.999%-Ga) PURATREM (13450-88-9) GaBr ₃ ; FW: 309.45; white granules; m.p. 121.5°; b.p. 278.8°; d. 3.69 <i>moisture sensitive</i>	1g 5g
93-3104 amp HAZ	Gallium(II) chloride, anhydrous (99.999%-Ga) PURATREM (13498-12-9) Ga ₂ Cl ₄ ; FW: 281.26; white xtl.; m.p. 164°; b.p. 535° <i>moisture sensitive</i>	1g 5g

GALLIUM (Compounds)

93-3141 amp HAZ	Gallium(III) chloride, anhydrous, fused lump (99.999%-Ga) PURATREM (13450-90-3) GaCl ₃ ; FW: 176.03; white fused lump; m.p. 77.9°; b.p. 201.3°; d. 2.47 <i>moisture sensitive</i>	5g 25g 100g
93-3140 HAZ	Gallium(III) chloride, anhydrous, granular (99.999%-Ga) PURATREM (13450-90-3) GaCl ₃ ; FW: 176.03; white crystalline powdr.; m.p. 77.9°; b.p. 201.3°; d. 2.47 <i>moisture sensitive</i> Note: Packaged in PFA/FET bottle.	5g 25g 100g
93-3117	Gallium(III) fluoride trihydrate, 99.5% (7783-51-9) GaF ₃ ·3H ₂ O; FW: 126.72 (180.76); white xtl.	1g 5g
31-1370 	Gallium (III) fluoride trihydrate (99.99%-Ga) PURATREM (7783-51-9) GaF ₃ ·3H ₂ O; FW: 126.72 (180.76); white xtl. <i>hygroscopic</i>	1g 5g
93-3110	Gallium(III) iodide, anhydrous, 99% (13450-91-4) GaI ₃ ; FW: 450.44; yellow powdr.; m.p. 212° <i>moisture sensitive</i>	5g 25g
93-3105 HAZ	Gallium(III) nitrate hydrate (99.99%-Ga) PURATREM (69365-72-6) Ga(NO ₃) ₃ ·XH ₂ O; FW: 255.73; white xtl.; m.p. 110° dec. <i>hygroscopic</i>	5g 25g
93-3106	Gallium(III) oxide (99.998%-Ga) PURATREM (12024-21-4) Ga ₂ O ₃ ; FW: 187.44; white powdr.; m.p. 1900°; d. 5.88	5g 25g 100g
93-3123	Gallium phosphide (99.999%-Ga) PURATREM (12063-98-8) GaP; FW: 100.69; amber xtl.; m.p. 1348°; d. 4.1	2g 10g
93-3126	Gallium(III) sulfate hydrate (99.999%-Ga) PURATREM (13780-42-2) Ga ₂ (SO ₄) ₃ ·XH ₂ O; FW: 427.62; white xtl.; d. 3.86 <i>hygroscopic</i>	5g
31-1300 HAZ	Gallium(III) trifluoromethanesulfonate, 98% (Gallium triflate) (74974-60-0) Ga(CF ₃ SO ₃) ₃ ; FW: 516.93; white powdr. <i>hygroscopic</i>	1g 5g
98-1862 HAZ 	Triethylgallium, elec. gr. (99.9999%-Ga) PURATREM (1115-99-7) (C ₂ H ₅) ₃ Ga; FW: 156.91; colorless liq.; m.p. -82.3°; b.p. 143°; f.p. 69.8°F; d. 1.0586 <i>moisture sensitive, pyrophoric</i>	50g 100g
31-2000 HAZ 	Trimethylgallium, 99+% (1445-79-0) (CH ₃) ₃ Ga; FW: 114.83; colorless liq.; m.p. -15.8°; b.p. 55.7°; f.p. -1°F; d. 1.151 <i>moisture sensitive, pyrophoric</i> Note: Available prepacked in ALD cylinder- see 98-4068.	25g 100g
98-4068 HAZ 	Trimethylgallium, 99+%, 31-2000, contained in 50 ml Swagelok® cylinder (96-1070) for CVD/ALD (1445-79-0) (CH ₃) ₃ Ga; FW: 114.83; colorless liq.; m.p. -15.8°; b.p. 55.7°; f.p. -1°F; d. 1.151 <i>moisture sensitive, pyrophoric</i>	10g 25g
98-2000 HAZ 	Trimethylgallium, elec. gr. (99.9999%-Ga) PURATREM (1445-79-0) (CH ₃) ₃ Ga; FW: 114.83; colorless liq.; m.p. -15.8°; b.p. 55.7°; f.p. -1°F; d. 1.151 <i>moisture sensitive, pyrophoric</i> Note: Available prepacked in ALD cylinder- see 98-4047.	50g 100g
98-4047 HAZ 	Trimethylgallium, elec. gr. (99.9999%-Ga) PURATREM, 98-2000, contained in 50 ml electropolished Swagelok® cylinder (96-1077) for CVD/ALD (1445-79-0) (CH ₃) ₃ Ga; FW: 114.83; colorless liq.; m.p. -15.8°; b.p. 55.7°; f.p. -1°F; d. 1.151 <i>moisture sensitive, pyrophoric</i>	10g 25g
31-5000	Tris(2,2,6,6-tetramethyl-3,5-heptanedionato)gallium(III), 99% (99.999%-Ga) [Ga(TMHD)₃] PURATREM (34228-15-4) Ga(C ₁₁ H ₁₉ O ₂) ₃ ; FW: 619.54; white xtl.; m.p. 219-220°; b.p. dec. 360° (subl. 170°/0.2mm)	1g 5g 25g

GERMANIUM (Elemental Forms)

93-3232	Germanium pieces (99.999%) (7440-56-4) Ge; FW: 72.59; irregular pieces (5-10mm); m.p. 937.4°; b.p. 2830°; d. 5.323	10g 50g
93-3231 HAZ	Germanium powder (99.999%) (7440-56-4) Ge; FW: 72.59; -100 mesh; m.p. 937.4°; b.p. 2830°; d. 5.323	5g 25g
93-3230 HAZ	Germanium powder (99.9999%) (7440-56-4) Ge; FW: 72.59; p.wdr.; m.p. 937.4°; b.p. 2830°; d. 5.323	5g 25g

GERMANIUM (Compounds)

93-3220 HAZ	Diethylgermanium dichloride, min. 97% (13314-52-8) (C ₂ H ₅) ₂ GeCl ₂ ; FW: 201.64; colorless liq.; b.p. 175°; d. 1.372 <i>moisture sensitive</i>	1g 5g
93-3202 amp HAZ	Dimethylgermanium dichloride, 99% (1529-48-2) (CH ₃) ₂ GeCl ₂ ; FW: 173.57; colorless liq.; m.p. -22°; b.p. 124°; f.p. 90°F; d. 1.488 (26°) <i>moisture sensitive</i>	1g 5g
93-3203 amp HAZ	Ethylgermanium trichloride, min. 97% (993-42-0) C ₂ H ₅ GeCl ₃ ; FW: 208.03; colorless liq.; m.p. -33°; b.p. 144°; d. 1.604 <i>moisture sensitive</i>	1g 5g
93-3225 amp HAZ	Germanium(IV) bromide (99.99+% -Ge) PURATREM (13450-92-5) GeBr ₄ ; FW: 392.23; white xtl.; m.p. 26.1°; b.p. 186.5°; d. 3.132 <i>moisture sensitive</i>	10g
32-0650 amp HAZ	Germanium(IV) chloride (99.99%-Ge) PURATREM (10038-98-9) GeCl ₄ ; FW: 214.40; colorless liq.; m.p. -49.5°; b.p. 83.1°; d. 1.880 <i>moisture sensitive</i>	10g 50g
32-0700 amp HAZ	Germanium(IV) chloride (99.9999%-Ge) PURATREM (10038-98-9) GeCl ₄ ; FW: 214.40; colorless liq.; m.p. -49.5°; b.p. 83.1°; d. 1.880 <i>moisture sensitive</i>	25g 100g 5 x 100g
93-3206 HAZ	Germanium(IV) ethoxide (99.99+% -Ge) PURATREM (14165-55-0) Ge(OC ₂ H ₅) ₄ ; FW: 252.85; colorless liq.; m.p. -81°; b.p. 185.5°; d. 1.14 <i>moisture sensitive</i>	1g 5g 25g
93-3205	Germanium(II) iodide (99.99+% -Ge) PURATREM (13573-08-5) GeI ₂ ; FW: 326.40; -10 mesh yellow p.wdr.; m.p. dec.; d. 5.73 <i>moisture sensitive</i>	1g 5g
93-3226 amp HAZ	Germanium(IV) iodide (99.999%-Ge) PURATREM (13450-95-8) GeI ₄ ; FW: 580.21; orange to red xtl.; m.p. 146°; b.p. 350°; d. 4.416 <i>moisture sensitive</i>	5g 25g
93-3221	Germanium(IV) oxide (99.999%-Ge) PURATREM (1310-53-8) GeO ₂ ; FW: 104.59; white p.wdr., hexagonal (soluble) form; m.p. 1111-1119°; d. 4.228	5g 25g
97-3222	Germanium(IV) oxide, elec. gr. (99.9999%-Ge) PURATREM (1310-53-8) GeO ₂ ; FW: 104.59; white p.wdr.; m.p. 1111-1119°; d. 4.228	10g 50g
93-3224	Germanium(IV) selenide (99.999%-Ge) PURATREM (12065-11-1) GeSe ₂ ; FW: 230.51; orange xtl.; m.p. 707°; d. 4.56	1g 5g
93-3209	Germanium(II) sulfide (99.99+% -Ge) (contains 1-5% germanium metal) PURATREM (12025-32-0) GeS; FW: 104.65; black xtl.; m.p. 530°	2g 10g
32-3215	Germanium(II) chloride dioxane adduct (28595-67-7) C ₄ H ₈ Cl ₂ GeO ₂ ; FW: 231.65 <i>moisture sensitive</i>	2g 10g
32-2050	Tetra-n-butylgermane, min. 98% (1067-42-1) (n-C ₄ H ₉) ₄ Ge; FW: 301.05; colorless liq.; b.p. 130-133°/5 mm; d. 0.934	5g 25g
93-3227 HAZ	Tetraethylgermane, 99% (597-63-7) (C ₂ H ₅) ₄ Ge; FW: 188.84; colorless liq.; m.p. -90°; b.p. 165.5°; f.p. 85°F; d. 1.1989	2g 10g
32-2125 HAZ	Tetramethylgermane, 99% (865-52-1) (CH ₃) ₄ Ge; FW: 132.73; colorless liq.; m.p. -88°; b.p. 43.4°; f.p. -35°F; d. 0.978	1g 5g 25g
32-2340 HAZ	Triethylgermanium chloride, 98% (994-28-5) (C ₂ H ₅) ₃ GeCl; FW: 195.23; colorless liq.; b.p. 179-180°; d. 1.175 <i>moisture sensitive</i>	1g 5g 25g

GERMANIUM (Compounds)

93-3214 HAZ	Trimethylgermanium bromide, 98+% (1066-37-1) (CH ₃) ₃ GeBr; FW: 197.60; colorless liq.; m.p. -25°; b.p. 113.7°; f.p. 99°F; d. 1.540 <i>moisture sensitive</i>	1g 5g
32-2410 amp HAZ	Trimethylgermanium chloride, min. 98% (1529-47-1) (CH ₃) ₃ GeCl; FW: 153.15; colorless liq.; m.p. -14°; b.p. 99-101°; f.p. 35°F; d. 1.2382 (22°) <i>moisture sensitive</i>	1g 5g
32-2550	Triphenylgermanium chloride, 99% (1626-24-0) (C ₆ H ₅) ₃ GeCl; FW: 339.36; white xtl.; m.p. 112-114°; b.p. 285°/12 mm <i>moisture sensitive</i>	1g 5g

GOLD (Elemental Forms)

79-0160	Gold 1% on aluminum oxide extrudates (AUROLite™ Au/Al₂O₃) (7440-57-5) See page 150	
79-0165	Gold 1% on titanium dioxide extrudates (AUROLite™ Au/TiO₂) (7440-57-5) See page 150	
79-0170	Gold 1% on zinc oxide granulate (AUROLite™ Au/ZnO) (7440-57-5) See page 151	
79-0050	Gold foil (99.9%) (7440-57-5) Au; FW: 197.20; 0.01mm thick (~0.12g/25mm x 25mm); m.p. 1064°; b.p. 2067°; d. 19.3	25 x 25mm 50 x 50mm
79-0060	Gold foil (99.95%) (7440-57-5) Au; FW: 197.20; 0.1mm thick (~1.2g/25mm x 25mm); m.p. 1064°; b.p. 2067°; d. 19.3	25 x 25mm 50 x 50mm
	Gold Gemini Nanorods, CTAB Free (7440-57-5) See page 157	
96-1549	Gold Gemini Nanorods Kit, CTAB Free (Wavelength 650-850 nm) See page 534	
79-0134	Gold Nanochain [AuNP-Chain: 1-2 μm (Gum Arabic)] (7440-57-5) See page 151	
79-0921 NEW	Gold nanoparticles, 1% on carbon black (surfactant and reactant-free) (7440-57-5) Au; FW: 196.70; black solid (store cold) Note: Manufactured by laser ablation. Sold in collaboration with Particular® for research purposes only.	5g 25g
79-0916 NEW	Gold nanoparticles, 1% on Titania (anatase) (surfactant and reactant-free) (7440-57-5) Au; FW: 196.70; dark purple pwdr. (store cold) Note: Manufactured by laser ablation. Sold in collaboration with Particular® for research purposes only.	5g 25g
79-0905 NEW	Gold nanoparticles, 1% on Titania (rutile) (surfactant and reactant-free) (7440-57-5) Au; FW: 196.70; purple solid (store cold) Note: Manufactured by laser ablation. Sold in collaboration with Particular® for research purposes only.	5g 25g
79-0926 NEW	Gold nanoparticles, 5% on carbon black (surfactant and reactant-free) (7440-57-5) Au; FW: 196.70; black solid (store cold) Note: Manufactured by laser ablation. Sold in collaboration with Particular® for research purposes only.	5g 25g
79-0935 NEW	Gold nanoparticles, 10% on Titania (anatase) (surfactant and reactant-free) (7440-57-5) Au; FW: 196.70; purple solid (store cold) Note: Manufactured by laser ablation. Sold in collaboration with Particular® for research purposes only.	1g 5g

GOLD (Elemental Forms)

79-0930	Gold nanoparticles, 10% on Titania (rutile) (surfactant and reactant-free) (7440-57-5) Au; FW: 196.70; dark purple solid (store cold) Note: Manufactured by laser ablation. Sold in collaboration with Particular® for research purposes only.	1g 5g
	NEW	
	Gold Nanoparticles (1 OD, stabilized suspension in phosphate-buffered saline) reactant free (7440-57-5) See page 152	
96-1545	Gold Nanoparticles Kit, Reactant-Free (5nm-40nm diameter, OD 1, suspension in phosphate-buffered saline, 515-530nm abs. max.) (7440-57-5) See page 535	
	Gold Nanoparticles (1 OD, supplied in 0.1mM stabilizing surfactant) (7440-57-5) See page 153	
96-1547	Gold Nanoparticles Kit (5nm-40nm diameter, OD 1, stabilized suspension citrate buffer) (7440-57-5) See page 534	
79-0235	Gold nanoparticles powder, 6nm, organic solvent-dispersible (7440-57-5) See page 151	
	Gold nanoparticles - surfactant and reactant-free (pure), manufactured via laser ablation (7440-57-5) See page 154	
	Spherical Gold Nanoparticles (7440-57-5) See page 154	
96-1540	Gold Nanospheres Kit (30-90 nm) (7440-57-5) See page 535	
	Sugar Coated Gold Nanoparticles (7440-57-5) See page 154	
79-0238	Gold nanoparticles with amine surface functional group, 6nm, in water (7440-57-5) See page 151	
79-0240	Gold nanoparticles with carboxylic acid surface functional group, 6nm, in water (7440-57-5) See page 152	
79-0136	Gold Nanorods [AuNP-Rod: Aspect Ratio: 3-3.5 (CTAB)] (7440-57-5) See page 156	
	Gold Nanorods (Axial Diameter - 10 nm) (7440-57-5) See page 156	
96-1535	Gold Nanorods Kit (Axial Diameter - 10 nm, wavelength 700-808 nm) (7440-57-5) See page 535	
	Gold Nanorods (Axial Diameter - 25 nm) (7440-57-5) See page 156	
96-1530	Gold Nanorods Kit (Axial Diameter - 25 nm, wavelength 550-700 nm) (7440-57-5) See page 535	
	Gold NanoUrchins (1 OD, 0.1 mM in phosphate-buffered saline) >95.0% reactant free See page 158	
	Water Soluble Gold Nanoparticles (7440-57-5) See page 155	
93-7912	Gold powder (99.9+%) (7440-57-5) Au; FW: 197.20; 1.5-3.0 micron spherical; m.p. 1064°; b.p. 2067°; d. 19.3	500mg 2g
93-7915	Gold powder (99.95%) (7440-57-5) Au; FW: 197.20; 2-5 micron; m.p. 1064°; b.p. 2067°; d. 19.3	500mg 2g
93-7902	Gold powder (99.999%) (7440-57-5) Au; FW: 197.20; -20 mesh; m.p. 1064°; b.p. 2067°; d. 19.3	500mg 2g
93-7913	Gold shot (99.95%) (7440-57-5) Au; FW: 197.20; 6.35 mm and down, semi-spherical; m.p. 1064°; b.p. 2067°; d. 19.3	500mg 2g

GOLD (Elemental Forms)

79-0075	Gold shot (99.999%) (7440-57-5) Au; FW: 197.20; 0.8-6 mm; m.p. 1064°; b.p. 2067°; d. 19.3	500mg 2.5g
79-0095	Gold wire (99.99%) (7440-57-5) Au; FW: 196.97; 1.4 mm dia.; b.p. 2067°; d. 19.3	2cm 10cm
79-0085	Gold wire (99.999%) (7440-57-5) Au; FW: 196.97; 1.4mm dia. (~0.6g/2cm); b.p. 2067°; d. 19.3	2cm 10cm
79-0080	Gold/tetra-n-octylammonium chloride colloid (7440-57-5) See page 151	

GOLD (Compounds)

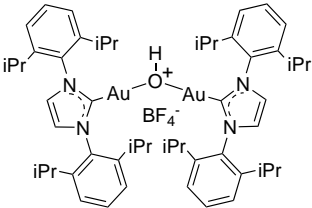
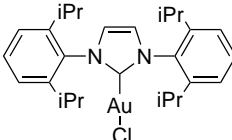
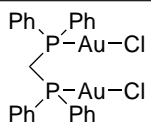
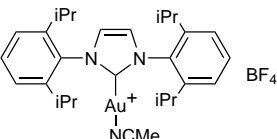
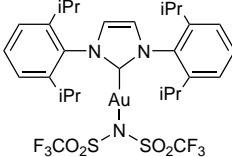
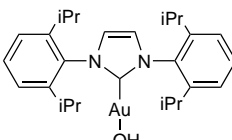
02-1000	Ammonium tetrachloroaurate(III) hydrate (99.9985%-Au) PURATREM (13874-04-9) See page 6		
79-0125	Bis(1,3-bis[2,6-bis(1-methylethyl)phenyl]-1,3-dihydro-2H-imidazol-2-ylidene)-μ-hydroxydigold(I) tetrafluoroborate, 99% (1262545-44-7) C ₆₄ H ₇₃ Au ₂ BF ₄ N ₄ O; FW: 1274.92; white solid For detailed technical note visit strem.com .		100mg 500mg
79-0200	1,3-Bis(2,6-di-isopropylphenyl)imidazol-2-ylidene-negold(I) chloride, 95% (852445-83-1) C ₂₇ H ₃₆ AuClN ₂ ; FW: 621.01; white powdr. (store cold) For detailed technical note visit strem.com .		250mg 1g
79-0115	[μ-Bis(diphenylphosphino) methane]dichlorodigold(I), 99% (37095-27-5) C ₂₆ H ₂₂ Au ₂ Cl ₂ P ₂ ; FW: 849.23; white powdr. For detailed technical note visit strem.com .		250mg 1g
79-0300	1,3-Bis(2,6-di-i-propylphenyl)imidazol-2-ylidene(acetonitrile)gold(I) tetrafluoroborate, 95% (896733-61-2) C ₂₆ H ₂₉ AuBF ₄ N ₃ ; FW: 713.41; white solid <i>air sensitive</i> Note: US Patent 7,767,841 For detailed technical note visit strem.com .		100mg 500mg
79-0245	[1,3-Bis(2,6-di-i-propylphenyl)imidazol-2-ylidene] [bis(trifluoromethanesulfonyl)imide]gold(I), min. 95% (951776-24-2) C ₂₆ H ₃₆ AuF ₆ O ₄ S ₂ ; FW: 865.7; white to pale yellow solid <i>air sensitive</i> For detailed technical note visit strem.com .		100mg 500mg
79-0205	1,3-Bis(2,6-di-i-propylphenyl)imidazol-2-ylidene-gold(I) hydroxide, min. 97% (1240328-73-7) C ₂₇ H ₃₇ AuN ₂ O; FW: 602.56; white microxtl. For detailed technical note visit strem.com .		100mg 500mg

GOLD (Compounds)

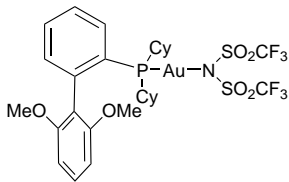
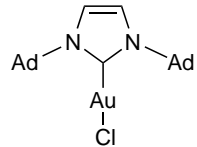
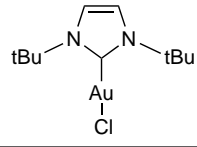
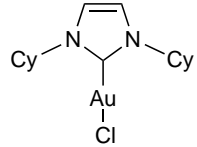
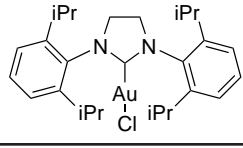
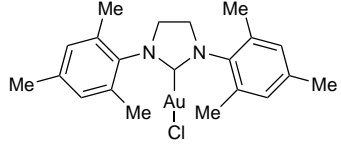
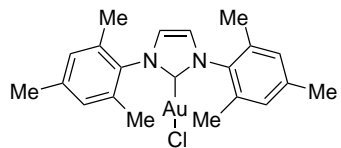
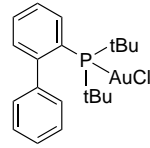
79-0230	<p>Bis(trifluoromethanesulfonyl)imide(2-dicyclohexylphosphino-2',6'-dimethoxy-1,1'-biphenyl)gold(I), 98% (1121960-90-4) $C_{26}H_{35}AuF_6NO_6PS_2$; FW: 887.64; white to off-white solid For detailed technical note visit strem.com.</p>		100mg 500mg
79-1225	<p>Chloro[1,3-bis(adamantyl)2H-imidazol-2-ylidene]gold(I), 98% (852445-88-6) $C_{23}H_{32}AuClN_2$; FW: 568.93; white to light-gray powder. <i>air sensitive</i> For detailed technical note visit strem.com.</p>		100mg 500mg
79-1215	<p>Chloro[1,3-bis(t-butyl)-2H-imidazol-2-ylidene]gold(I), 98% (839722-07-5) $C_{11}H_{20}AuClN_2$; FW: 412.71; white powder. <i>air sensitive</i> For detailed technical note visit strem.com.</p>		100mg 500mg
79-1220	<p>Chloro[1,3-bis(cyclohexyl)2H-imidazol-2-ylidene]gold(I), 98% (852445-87-5) $C_{15}H_{24}AuClN_2$; FW: 464.78; white to light-gray powder. <i>air sensitive</i></p>		100mg 500mg
79-1210	<p>Chloro[1,3-bis[2,6-di-i-propylphenyl]-4,5-dihydroimidazol-2-ylidene]gold(I), 98% SiPrAuCl (852445-84-2) $C_{27}H_{38}AuClN_2$; FW: 623.02; white powder. <i>air sensitive</i> For detailed technical note visit strem.com.</p>		100mg 500mg
79-1205	<p>Chloro[1,3-bis(2,4,6-trimethylphenyl)-4,5-dihydroimidazol-2-ylidene]gold(I), 98% (852445-82-0) $C_{21}H_{26}AuClN_2$; FW: 538.86; white powder. <i>air sensitive</i> For detailed technical note visit strem.com.</p>		100mg 500mg
79-1200	<p>Chloro[1,3-bis(2,4,6-trimethylphenyl)2H-imidazol-2-ylidene]gold(I), 98% (852445-81-9) $C_{21}H_{24}AuClN_2$; FW: 536.85; white powder. <i>air sensitive</i> For detailed technical note visit strem.com.</p>		100mg 500mg
79-0350	<p>Chlorocarbonylgold(I), min. 97% (50960-82-2) $Au(CO)Cl$; FW: 260.43; off-white powder. <i>air sensitive, moisture sensitive, (store cold)</i></p>		250mg 1g
79-0340	<p>Chloro[2-(di-t-butylphosphino)-1,1'-biphenyl]gold(I), 99% (854045-93-5) $C_{20}H_{27}AuClP$; FW: 530.82; white powder.</p>		250mg 1g

GOLD (Compounds)

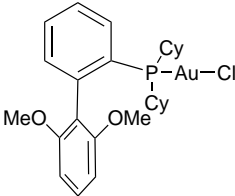
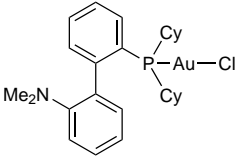
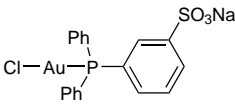
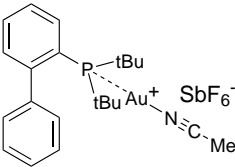
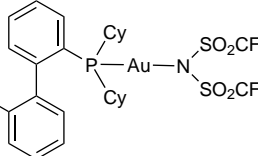
79-0225	Chloro(2-dicyclohexylphosphino-2',6'-dimethoxy-1,1'-biphenyl)gold(I), 98% (854045-95-7) $C_{26}H_{35}AuClO_2P$; FW: 642.95; white powdr. For detailed technical note visit strem.com .		250mg 1g
79-0343	Chloro[2-(dicyclohexylphosphino)-2'-(N,N-dimethylamino)-1,1'-biphenyl]gold(I), 98% (1196707-11-5) $C_{26}H_{36}AuClNP$; FW: 625.96; white powdr. For detailed technical note visit strem.com .		250mg 1g
79-0345	Chloro(dimethylsulfide)gold(I), min. 97% (29892-37-3) $(CH_3)_2SAuCl$; FW: 294.55; white to off-white solid <i>light sensitive, (store cold)</i> For detailed technical note visit strem.com .		250mg 1g 5g
79-1100	Chloro[diphenyl(3-sulfonatophenyl)phosphine]gold(I), sodium salt hydrate, min. 98% $AuCl[(C_6H_5)_2P(C_6H_4SO_3Na)] \cdot xH_2O$; FW: 596.75; white to off-white powdr. <i>light sensitive, (store cold)</i>		250mg 1g
79-1122	Chloro(tetrahydrothiophene)gold(I), min. 98% (39929-21-0) $(C_4H_8S)AuCl$; FW: 320.59; white to off-white powdr. <i>air sensitive, heat sensitive, light sensitive, (store cold)</i> For detailed technical note visit strem.com .		100mg 500mg
79-0740	Chlorotri-<i>t</i>-butylphosphinegold(I), 99% (69550-28-3) $AuCIP(C_tH_9)_3$; FW: 434.74; white microxtl. For detailed technical note visit strem.com .		250mg 1g
79-0750	Chlorotriethylphosphinegold(I), 99% (15529-90-5) HAZ $AuCIP(C_2H_5)_3$; FW: 350.57; white to pink xtl.; m.p. 85-87°		250mg 1g 5g
79-0850	Chlorotrimethylphosphinegold(I), min. 98% (15278-97-4) $AuCIP(CH_3)_3$; FW: 308.49; white xtl.; m.p. 225-228°		100mg 500mg 2g
79-1000	Chlorotriphenylphosphinegold(I), 98+% (99.9+% Au) (14243-64-2) $AuCIP(C_6H_5)_3$; FW: 494.71; white xtl.		250mg 1g 5g
79-0352	2-(Di-<i>t</i>-butylphosphino)-1,1'-biphenyl(ace-tonitrile)gold(I) hexafluoroantimonate, 99% (866641-66-9) $C_{22}H_{30}F_6AuNPSb$; FW: 772.17; white to off-white powdr. <i>air sensitive, moisture sensitive</i> For detailed technical note visit strem.com .		250mg 1g
79-0348	[2-(Dicyclohexylphosphino)-2'-(N,N-dimethylamino)-1,1'-biphenyl][bis(trifluoromethyl) sulfonylimido]gold(I), 98% (1188507-66-5) $C_{28}H_{36}AuF_6N_2O_4PS_2$; FW: 870.66; yellow powdr. For detailed technical note visit strem.com .		250mg 1g
79-1500	Dimethyl(acetylacetonate)gold(III), 98% (99.9%-Au) (14951-50-9) $(CH_3)_2(C_5H_7O_2)Au$; FW: 326.60; white to off-white xtl.; m.p. 81-82°; b.p. subl. -25°/0.01mm <i>(store cold)</i>		500mg 2g

GOLD (Compounds)

Technical Notes:

- Highly volatile gold source for MOCVD applications. Must ship overnight in dry ice.
- Precursor for synthesis of gold nanoparticles. Au/ZrO₂ and Au/Al₂O₃ prepared in this way were extremely efficient catalysts for the aerobic oxidation of glucose. (Ref. 1)

References:

- Angew. Chem. Int. Ed.*, **2008**, *47*, 9265

79-1600	Dimethyl(trifluoroacetylacetonate)gold(III), 98% (99.9%-Au) (63470-53-1)	500mg
HAZ	(CH ₃) ₂ Au(CF ₃ COCHCOCH ₃); FW: 380.12; white to off-white xtl. <i>air sensitive, heat sensitive, light sensitive, (store cold)</i>	2g

Technical Note:

- Highly volatile gold source for MOCVD applications. Must ship overnight in dry ice.

79-2015	Diphenyl(m-sulfonatophenyl)phosphine-gold nanocluster (water soluble) (1-3 nm) See page 158	
93-7905	Gold(III) bromide, anhydrous, 99% (99.9%-Au) (10294-28-7)	1g
HAZ	AuBr ₃ ; FW: 436.69; orange to brown powdr. <i>moisture sensitive</i>	5g
79-1900	Gold(I) chloride, 97% (99.99%-Au) PURATREM (10294-29-8)	250mg
	AuCl; FW: 232.42; yellow powdr.; m.p. 289° dec.; d. 7.4	1g
		5g
93-7907	Gold(III) chloride, 99% (99.9%-Au) (13453-07-1)	250mg
	AuCl ₃ ; FW: 303.33; red-brown solid; m.p. 254° dec. <i>light sensitive, moisture sensitive</i>	1g
		5g
93-7901	Gold(I) cyanide (99.9%-Au) (506-65-0)	1g
HAZ	AuCN; FW: 222.98; yellow powdr.; m.p. ~50° (dec.); d. 7.12	5g
79-2000	Gold(I) iodide, 99% (99.9%-Au) (10294-31-2)	1g
	AuI; FW: 323.87; yellowish-green powdr.; m.p. 120° dec.; d. 8.25 <i>(store cold)</i>	5g
93-7903	Gold(III) oxide, 99% (1303-58-8)	1g
	Au ₂ O ₃ ; FW: 441.93; orange to brown powdr.; m.p. 150° (dec.)	5g
79-2035	Hexachlorododecakis[diphenyl(m-sulfonatophenyl)phosphine] pentapentacontagold, dodecasodium salt (water soluble) Schmid Au₅₅ Cluster (115804-59-6) See page 158	
79-2030	Hexachlorododecakis(triphenylphosphine)pentapentacontagold Schmid Au₅₅ Cluster (104619-10-5) See page 158	
79-2150	Hydrogen tetrabromoaurate(III) hydrate (99.9%-Au) (17083-68-0)	1g
HAZ	HAuBr ₄ ·XH ₂ O; FW: 517.61; black xtl. <i>moisture sensitive</i>	5g
79-0500	Hydrogen tetrachloroaurate (III) hydrate (99.8%-Au) (min. 49% Au)(Chloroauric acid) (27988-77-8)	1g
HAZ	HAuCl ₄ ·XH ₂ O; FW: 339.79; yellow to orange xtl. <i>light sensitive, hygroscopic, (store cold)</i>	5g
		25g
79-2200	Hydrogen tetrachloroaurate(III) hydrate (99.9985%-Au) (49% Au) PURATREM (27988-77-8)	1g
HAZ	HAuCl ₄ ·XH ₂ O; FW: 339.79; yellow to orange xtl. <i>light sensitive, hygroscopic, (store cold)</i>	5g
79-5000	Methyl(triphenylphosphine)gold(I), 99% (23108-72-7)	250mg
	Au(CH ₃)P(C ₆ H ₅) ₃ ; FW: 474.29; white xtl.; m.p. ~150° (dec.) For detailed technical note visit strem.com .	1g
79-3000	Potassium dicyanoaurate(I), 99% (13967-50-5) See page 341	
79-3250	Potassium tetrabromoaurate(III) dihydrate, 99% (14323-32-1) See page 344	
93-7906	Potassium tetrachloroaurate(III) hydrate (99.99%-Au) (51%-Au) PURATREM (13682-61-6) See page 344	
79-3505	Sodium tetrabromoaurate(III) hydrate (99.9%-Au) (52495-41-7) See page 421	

GOLD (Compounds)

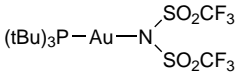
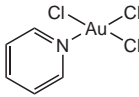
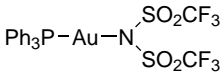
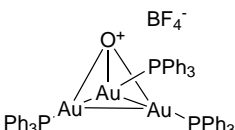
79-0355	Tri-<i>t</i>-butylphosphine[bis(trifluoromethyl)sulfonylimido]gold(I), 98% (1121960-93-7) C ₁₄ H ₂₇ AuF ₆ NO ₂ PS ₂ ; FW: 679.43; white solid For detailed technical note visit strem.com .		100mg 500mg
79-3590	Trichloropyridinegold(III), min. 97% (14911-01-4) (C ₅ H ₅ N)AuCl ₃ ; FW: 382.43; pale yellow powder.		250mg 1g
79-3615	Triphenylphosphinegold(I) bis(trifluoromethanesulfonyl)imide, min. 98% (866395-16-6) [(C ₆ H ₅) ₃ PAu] ⁺ [N(CF ₃ SO ₂) ₂] ₂ ⁻ ; FW: 739.4; white to off-white powder. <i>air sensitive, light sensitive, (store cold)</i> For detailed technical note visit strem.com .		250mg 1g
79-3600	Tris(triphenylphosphinegold(I))oxonium tetrafluoroborate, 98% (53317-87-6) [(C ₆ H ₅) ₃ PAu] ₃ O ⁺ BF ₄ ⁻ ; FW: 1480.56; off-white powder; m.p. 207° dec. <i>air sensitive</i> For detailed technical note visit strem.com .		250mg 1g

HAFNIUM (Elemental Forms)

72-0055	Hafnium crystal bar chips (99.7%, Zr~3%) (7440-58-6) Hf; FW: 178.49; 5/8" x 1.5" pieces; m.p. 2227°; b.p. 4602°; d. 13.31	25g 100g
72-0070	Hafnium foil (99.5%, Zr-2.9%) (7440-58-6) Hf; FW: 178.49; 1.0mm thick; m.p. 2227°; b.p. 4602°; d. 13.31	50 x 50mm 100 x 100mm
72-0075	Hafnium foil (99.5%, Zr-2.9%) (7440-58-6) Hf; FW: 178.49; 0.254mm thick; m.p. 2227°; b.p. 4602°; d. 13.31	50 x 50mm 100 x 100mm
93-7225	Hafnium powder (99.6%, Zr-3.1%) (7440-58-6) HAZ Hf; FW: 178.49; -80 + 200 mesh; m.p. 2227°; b.p. 4602°; d. 13.31 <i>pyrophoric</i>	2g 10g
93-7227	Hafnium powder (99.6%, Zr-2.2%) (7440-58-6) HAZ Hf; FW: 178.49; -325 mesh; m.p. 2227°; b.p. 4602°; d. 13.31 <i>pyrophoric</i>	2g 10g 50g
72-0085	Hafnium wire (99.97%, Zr-3.1%) (7440-58-6) Hf; FW: 178.49; 1.0mm dia. (~2.6g/25cm); m.p. 2227°; b.p. 4602°; d. 13.31	25cm 100cm

HAFNIUM (Compounds)

72-0700	Bis(cyclopentadienyl)dimethylhafnium, min. 97% (37260-88-1) (C ₅ H ₅) ₂ Hf(CH ₃) ₂ ; FW: 338.75; white xtl.; b.p. subl. 90°/0.1mm <i>air sensitive, (store cold)</i>	500mg 2g
72-1000	Bis(cyclopentadienyl)hafnium dichloride, min. 98% (Hafnocene dichloride) (12116-66-4) (C ₅ H ₅) ₂ HfCl ₂ ; FW: 379.59; off-white xtl. <i>moisture sensitive</i>	1g 5g 25g
72-1250	Bis(ethylcyclopentadienyl)hafnium dichloride, min. 98% (78205-93-3) [C ₅ H ₄ (C ₂ H ₅) ₂] ₂ HfCl ₂ ; FW: 435.69; white powder. <i>moisture sensitive</i>	1g 5g
72-1500	Bis(pentamethylcyclopentadienyl)hafnium dichloride, min. 98% (85959-83-7) [(CH ₃) ₅ C ₅] ₂ HfCl ₂ ; FW: 519.86; white xtl. <i>moisture sensitive</i>	1g 5g
72-2000	Bis(<i>i</i>-propylcyclopentadienyl)hafnium dichloride, min. 98% (66349-80-2) [C ₅ H ₄ (C ₃ H ₇) ₂] ₂ HfCl ₂ ; FW: 463.76; white xtl. <i>moisture sensitive</i>	1g 5g
72-1900	Dimethylbis(<i>t</i>-butylcyclopentadienyl)hafnium(IV), min. 98% (68193-45-3) [(C ₄ H ₉) ₂ C ₅ H ₄] ₂ Hf(CH ₃) ₂ ; FW: 450.96; white xtl. <i>air sensitive, moisture sensitive</i>	1g 5g 25g

HAFNIUM (Compounds)

72-2002	Hafnium(IV) acetylacetonate, min. 96% (17475-67-1) Hf(CH ₃ COCHCOCH ₃) ₄ ; FW: 574.93; white to off-white powdr.	1g 5g 25g
93-7217 HAZ	Hafnium(IV) bromide, anhydrous, 98% (99.7%-Hf) (13777-22-5) HfBr ₄ ; FW: 498.13; -20 mesh tan powdr.; m.p. 220° subl. <i>moisture sensitive</i>	1g 5g
72-5800 amp	Hafnium(IV) t-butoxide (99.9%-Hf, <1.5%-Zr) (2172-02-3) Hf[OC(CH ₃) ₃] ₄ ; FW: 470.65; liq. (may contain small amount of white sediment); b.p. 90°/5 mm; d. 1.166 <i>light sensitive, moisture sensitive</i>	2g 10g
72-0751 HAZ	Hafnium(IV) chloride, sublimed grade (99.9+%-Hf, <1.0% Zr) (13499-05-3) HfCl ₄ ; FW: 320.30; white powdr.; m.p. 320° subl. <i>moisture sensitive</i>	10g 50g 250g
72-0752 HAZ	Hafnium(IV) chloride, sublimed grade (99.9+%-Hf, <0.05% Zr) (13499-05-3) HfCl ₄ ; FW: 320.30; white powdr.; m.p. 320° subl. <i>moisture sensitive</i>	1g 5g 25g
93-7207	Hafnium(IV) dichloride oxide octahydrate (98+%-Hf, 1.5% Zr) (14456-34-9) HfOCl ₂ ·8H ₂ O; FW: 265.40 (409.52); white powdr.	10g 50g
72-5900	Hafnium(IV) ethoxide, 99% (13428-80-3) Hf(OC ₂ H ₅) ₄ ; FW: 358.73; white to off-white xtl. <i>moisture sensitive</i>	5g 25g
93-7204	Hafnium(IV) oxide, 98% (12055-23-1) HfO ₂ ; FW: 210.49; off-white powdr.; m.p. 2812°; d. 9.68	10g 50g
72-5200	Hafnium(IV) oxide (99.995%-Hf, <0.15% Zr) PURATREM (12055-23-1) HfO ₂ ; FW: 210.49; off-white powdr.; m.p. 2812°; d. 9.68	1g 5g
72-5950	Hafnium(IV) i-propoxide monoisopropylate, 99% (2171-99-5) Hf(OC ₃ H ₇) ₄ ·C ₃ H ₇ OH; FW: 414.84 (474.94); white xtl. <i>moisture sensitive</i> For detailed technical note visit strem.com .	5g 25g
72-6000	Pentamethylcyclopentadienyhafnium trichloride, min. 98% (75181-08-7) (CH ₃) ₅ C ₅ HfCl ₃ ; FW: 420.08; off-white xtl. <i>moisture sensitive</i>	1g 5g
72-7000	i-Propylcyclopentadienyhafnium trichloride, min. 98% (329736-06-3) C ₅ H ₄ (C ₃ H ₇)HfCl ₃ ; FW: 392.03; off-white powdr. <i>light sensitive, moisture sensitive</i>	1g 5g
72-7700 amp HAZ	Tetrabenzylhafnium, min. 97% (31406-67-4) (C ₆ H ₅ CH ₂) ₄ Hf; FW: 543.01; yellow powdr. <i>air sensitive, heat sensitive, moisture sensitive, (store cold)</i>	100mg 500mg 2g 10g
72-7750 amp HAZ	Tetrakis(diethylamino)hafnium, 99% (99.99+%-Hf, <0.2% Zr) PURATREM (19824-55-6) Hf[N(CH ₂ CH ₃) ₂] ₄ ; FW: 467.01; light yellow liq. <i>moisture sensitive</i>	1g 5g 25g
72-8000 HAZ	Tetrakis(dimethylamino)hafnium, 98+% (99.99+%-Hf, <0.2% Zr) TDMAH, PURATREM (19782-68-4) Hf(N(CH ₃) ₂) ₄ ; FW: 354.79; colorless to pale yellow xtl.; m.p. 38-41°; b.p. 85°/0.1mm; d. 1.098 <i>moisture sensitive, (store cold)</i> Note: Product sold under, use subject to, terms and conditions of label license at www.strem.com/harvard1 . Available prepacked in ALD cylinder- see 98-4021, 98-4022.	1g 5g 25g

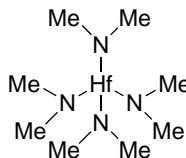
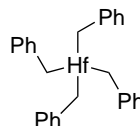

HAFNIUM (Compounds)

98-4021 HAZ	Tetrakis(dimethylamino)hafnium, 98+% (99.99+% Hf, <0.2%-Zr) TDMAH, PURATREM, 72-8000, contained in 50 ml Swagelok® cylinder (96-1070) for CVD/ALD (19782-68-4) Hf(N(CH ₃) ₂) ₄ ; FW: 354.79; colorless to pale yellow xtl.; m.p. 38-41°; b.p. 85°/0.1mm <i>moisture sensitive, (store cold)</i> Note: High temperature Swagelok® cylinder assembly 96-1071 available at extra cost. See 98-4022. Product sold under, use subject to, terms and conditions of label license at www.strem.com/harvard1 .	25g
98-4022 HAZ	Tetrakis(dimethylamino)hafnium, 98+% (99.99+% Hf, <0.2%-Zr) TDMAH, PURATREM, 72-8000, contained in 50ml Swagelok® cylinder (96-1071) for CVD/ALD (19782-68-4) Hf(N(CH ₃) ₂) ₄ ; FW: 354.79; colorless to pale yellow xtl. <i>moisture sensitive, (store cold)</i> Note: Product sold under, use subject to, terms and conditions of label license at www.strem.com/harvard1 .	25g
72-7720 amp HAZ	Tetrakis(ethylmethylamino)hafnium, 99% (99.99+% Hf, <0.15% Zr) TEMA H PURATREM (352535-01-4) Hf[(N(CH ₃)(CH ₂ CH ₃)) ₂] ₄ ; FW: 410.90; colorless to yellow liq.; d. 1.324 <i>moisture sensitive</i> Note: Available prepacked in ALD cylinder- see 98-4048. Volatile precursor for the ALD, CVD and MOCVD deposition of hafnium oxide.	2g 10g
98-4048 HAZ	Tetrakis(ethylmethylamino)hafnium, 99% (99.99+% Hf, <0.15% Zr) TEMA H, PURATREM, 72-7720, contained in 50 ml Swagelok® cylinder (96-1070) for CVD/ALD (352535-01-4) Hf[(N(CH ₃)(CH ₂ CH ₃)) ₂] ₄ ; FW: 410.90; colorless to yellow liq.; f.p. 52°F <i>moisture sensitive</i> Note: High temperature Swagelok® cylinder assembly 96-1071 available at extra cost.	10g
72-7580 NEW	Tetrakis(2,2,6,6-tetramethyl-3,5-heptanedionato)hafnium(IV), 99% (63370-90-1) C ₄₄ H ₇₆ HfO ₈ ; FW: 911.56; white xtl.	1g 5g 25g

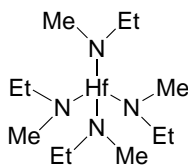
**HOLMIUM (Elemental Forms)**

93-6731	Holmium chips (99% REO) (7440-60-0) Ho; FW: 164.93; silver metal; m.p. 1474°; b.p. 2695°; d. 8.795 <i>air sensitive, moisture sensitive</i>	2g 10g
93-6733	Holmium foil (99.9% REO) (7440-60-0) Ho; FW: 164.93; 0.127 mm thick (~0.7g/25x 25 mm); m.p. 1474°; b.p. 2695°; d. 8.795 <i>air sensitive, moisture sensitive</i>	25 x 25mm 50 x 50mm
93-6734	Holmium foil (99.9% REO) (7440-60-0) Ho; 0.25 mm thick (~1.38g/25x 25 mm); m.p. 1474°; b.p. 2695°; d. 8.795 <i>air sensitive, moisture sensitive</i>	25 x 25mm 50 x 50mm
93-6732	Holmium ingot (99.9% REO) (7440-60-0) Ho; FW: 164.93; ingot; m.p. 1474°; b.p. 2695°; d. 8.795 <i>air sensitive, moisture sensitive</i> For detailed technical note visit strem.com .	5g 25g
93-6730 HAZ	Holmium powder (99.9% REO) (7440-60-0) Ho; FW: 164.93; -40 mesh; m.p. 1474°; b.p. 2695°; d. 8.795 <i>air sensitive, moisture sensitive</i>	2g 10g

HOLMIUM (Compounds)

93-6726	Holmium(III) acetate monohydrate (99.9%-Ho) (REO) (25519-09-9) Ho(OOCCH ₃) ₃ ·H ₂ O; FW: 342.07 (360.09); peach powdr.	10g 50g
93-6721	Holmium(III) chloride, anhydrous (99.9%-Ho) (REO) (10138-62-2) HoCl ₃ ; FW: 271.29; off-white powdr.; m.p. 718° <i>hygroscopic</i>	5g 25g
93-6722	Holmium(III) chloride hexahydrate (99.9%-Ho) (REO) (14914-84-2) HoCl ₃ ·6H ₂ O; FW: 271.29 (379.38); pink xtl.	2.5g 10g 50g

HOLMIUM (Compounds)

93-6712 HAZ	Holmium(III) nitrate hydrate (99.9%-Ho) (REO) (14483-18-2) Ho(NO ₃) ₃ ·XH ₂ O; FW: 350.95; orange xtl. <i>hygroscopic</i>	5g 25g
93-6713	Holmium(III) oxide (99.9%-Ho) (REO) (12055-62-8) Ho ₂ O ₃ ; FW: 377.86; off-white to pink powdr.; m.p. 2360°; d. 8.36	5g 25g
67-6000	Holmium(III) trifluoromethanesulfonate, min. 98% (Holmium triflate) (139177-63-2) Ho(CF ₃ SO ₃) ₃ ; FW: 612.14; white to off-white powdr. <i>hygroscopic</i>	5g 25g
67-5000	Tris(2,2,6,6-tetramethyl-3,5-heptanedionato)holmium(III), 99% (99.9%-Ho) (REO) [Ho(TMHD)₃] (15522-73-3) Ho(C ₁₁ H ₁₉ O ₂) ₃ ; FW: 714.75; off-white xtl.; m.p. 179-181°; b.p. dec. 290°	1g 5g

INDIUM (Elemental Forms)

49-0050	Indium foil (99.99%) (7440-74-6) In; FW: 114.76; 0.127mm thick (~2.3g/50 x 50mm); m.p. 156.6°; b.p. 2080°; d. 7.31	50 x 50mm 100 x 100mm 150 x 300mm
93-4940 HAZ	Indium powder (99.99%) (7440-74-6) In; FW: 114.76; -325 mesh; m.p. 156.6°; b.p. 2080°; d. 7.31	5g 25g
93-4941 HAZ	Indium powder (99.999%) (7440-74-6) In; FW: 114.76; -325 mesh; m.p. 156.6°; b.p. 2080°; d. 7.31	5g 25g
93-4942	Indium shot (99.9%) (7440-74-6) In; FW: 114.76; 4 mm tear drops; m.p. 156.6°; b.p. 2080°; d. 7.31	5g 25g
93-4944	Indium shot (99.99%) (7440-74-6) In; FW: 114.76; 4 mm tear drops; m.p. 156.6°; b.p. 2080°; d. 7.31	5g 25g
93-4943	Indium shot (99.9999%) (7440-74-6) In; FW: 114.76; 4-8 mm; m.p. 156.6°; b.p. 2080°; d. 7.31	5g 25g
49-1000	Indium wire (99.9985%) (7440-74-6) In; FW: 114.76; 0.5mm dia. (~3.6g/2.5m); m.p. 156.6°; b.p. 2080°; d. 7.31	2.5m 10m

INDIUM (Compounds)

98-4057 HAZ	Cyclopentadienylindium (I), elec. gr. (99.99+%-In) PURATREM, 97-3425, contained in 50 ml Swagelok® cylinder (96-1070) for CVD/ALD (34822-89-4) C ₅ H ₅ In; FW: 179.92; off-white to light yellow xtl.; b.p. subl. 50°/0.01mm <i>air sensitive, heat sensitive, light sensitive</i>	5g
97-3425 HAZ	Cyclopentadienylindium(I), elec. gr. (99.99+%-In) PURATREM (34822-89-4) C ₅ H ₅ In; FW: 179.92; off-white to light yellow xtl.; b.p. subl. 50°/0.01 mm <i>air sensitive, heat sensitive, light sensitive</i> Note: Available prepacked in ALD cylinder- see 98-4057, 98-4054.	250mg 1g 5g

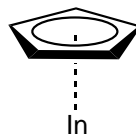

Technical Note:







1. ALD precursor for Indium oxide using cyclopentadienyl indium and mixture of water and oxygen.

References:

1. *ECS Transactions*, 2011, 41, 2, 147

98-4054 HAZ	Cyclopentadienylindium(I), elec. gr. (99.99+%-In) PURATREM, 97-3425, contained in 50 ml electropolished Swagelok® cylinder (96-1077) for CVD/ALD (34822-89-4) C ₅ H ₅ In; FW: 179.92; off-white to light yellow xtl.; b.p. subl. 50°/0.01 mm <i>air sensitive, heat sensitive, light sensitive</i>	5g
93-4936	Indium(III) acetate (99.99%-In) PURATREM (25114-58-3) In(OOCCH ₃) ₃ ; FW: 291.95; white xtl. <i>moisture sensitive</i>	5g 25g
93-4901	Indium(III) acetylacetonate, 98% (14405-45-9) In(CH ₃ COCHCOCH ₃) ₃ ; FW: 412.15; off-white powdr.; m.p. 180-185°	5g 25g
93-4920	Indium(III) antimonide (99.99%-In) PURATREM (1312-41-0) InSb; FW: 236.57; black xtl.; m.p. 535°; d. 5.76	5g 25g

INDIUM (Compounds)

93-4929	Indium(III) bromide, anhydrous (99.999%-In) PURATREM (13465-09-3) InBr ₃ ; FW: 354.55; white to light yellow powdr.; m.p. ~436°; d. 4.74 <i>hygroscopic</i>	5g 25g
93-4930	Indium(I) chloride, anhydrous (99.99%-In) PURATREM (13465-10-6) InCl; FW: 150.27; golden yellow powdr.; m.p. ~225°; b.p. 608°; d. 4.19 <i>air sensitive, moisture sensitive</i>	2g 10g
93-4932	Indium(III) chloride, anhydrous (99.999%-In) PURATREM (10025-82-8) InCl ₃ ; FW: 221.18; white powdr.; m.p. 586°; d. 3.46 <i>hygroscopic</i>	5g 25g 100g
93-4931	Indium(III) chloride tetrahydrate (99.99%-In) PURATREM (22519-64-8) InCl ₃ ·4H ₂ O; FW: 221.18 (293.26); white xtl.	5g 25g 100g
49-1500	Indium(III) fluoride, anhydrous, 98% (7783-52-0) InF ₃ ; FW: 171.82; white powdr.; m.p. ~1170°; b.p. > 1200° <i>hygroscopic</i>	5g 25g
93-4915	Indium(III) iodide (99.999%-In) PURATREM (13510-35-5) InI ₃ ; FW: 495.53; yellow to red solid; m.p. 210°; d. 4.69 <i>hygroscopic</i>	1g 5g 25g
93-4923 HAZ	Indium(III) nitrate hydrate (99.999%-In) PURATREM (13465-14-0) In(NO ₃) ₃ ·XH ₂ O; FW: 300.83; white xtl. <i>hygroscopic</i>	10g 50g
93-4906	Indium(III) oxide (99.998%-In) PURATREM (1312-43-2) In ₂ O ₃ ; FW: 277.64; yellow powdr.; d. 7.179	5g 25g
93-4925 HAZ	Indium(III) perchlorate octahydrate (99.9%-In) (13465-15-1) In(ClO ₄) ₃ ·8H ₂ O; FW: 413.17 (557.26); white xtl.; m.p. ~80°; b.p. 200° dec.	5g 25g
93-4926	Indium(III) phosphide (99.999%-In) PURATREM (22398-80-7) InP; FW: 145.79; black xtl.; 1/4" pieces and down; m.p. 1070°	1g 5g
93-4927	Indium(III) sulfate hydrate (99.999%-In) PURATREM (13464-82-9) In ₂ (SO ₄) ₃ ·XH ₂ O; FW: 517.83; white xtl.	10g 50g
93-4911	Indium(III) sulfide (99.99%-In) PURATREM (12030-24-9) In ₂ S ₃ ; FW: 325.83; orange powdr.; m.p. 1050°; d. 4.45	5g 25g
93-4904	Indium(III) trifluoroacetate, 99% (36554-90-2) In(OOCCF ₃) ₃ ; FW: 453.87; white powdr. <i>hygroscopic</i>	5g
93-4905	Indium(III) trifluoroacetylacetonate, 99% (15453-87-9) In(CF ₃ COCHCOCH ₃) ₃ ; FW: 574.06; white powdr.	1g
49-1800	Indium(III) trifluoromethanesulfonate, 99% (Indium triflate) (128008-30-0) In(CF ₃ SO ₃) ₃ ; FW: 562.02; white powdr.; m.p. dec. <i>hygroscopic</i>	5g 25g
49-2010 amp HAZ  	Trimethylindium, 98+% (99.9+%-In) (3385-78-2) (CH ₃) ₃ In; FW: 159.92; white xtl.; m.p. 88°; f.p. -1°F; d. 1.568 <i>heat sensitive, moisture sensitive, pyrophoric, (store cold)</i>	2g 10g
WARNING - Trimethylindium may undergo rapid thermal decomposition if exposed to temperatures above 100°C. Never attempt to distill the material at atmospheric pressure		
98-2010 HAZ  	Trimethylindium, elec. gr. (99.999%-In) PURATREM (3385-78-2) (CH ₃) ₃ In; FW: 159.93; white xtl.; m.p. 88°; f.p. -1°F; d. 1.568 <i>heat sensitive, moisture sensitive, pyrophoric, (store cold)</i> Note: Available prepacked in ALD cylinder- see 98-4056.	25g 100g
WARNING - Trimethylindium may undergo rapid thermal decomposition if exposed to temperatures above 100°C. Never attempt to distill the material at atmospheric pressure		
98-4056 HAZ  	Trimethylindium, elec. gr. (99.999%-In) PURATREM, 98-2010, contained in 50 ml electropolished Swagelok® cylinder (96-1077) for CVD/ALD (3385-78-2) (CH ₃) ₃ In; FW: 159.93; white xtl.; m.p. 88°; f.p. -1°F; d. 1.568 <i>heat sensitive, moisture sensitive, pyrophoric, (store cold)</i>	25g
WARNING - Trimethylindium may undergo rapid thermal decomposition if exposed to temperatures above 100°C. Never attempt to distill the material at atmospheric pressure		



INDIUM (Compounds)

49-2200	Tris(2,2,6,6-tetramethyl-3,5-heptanedionato)indium(III), 99% (99.9%-In) [In(TMHD) ₃] (34269-03-9) In(C ₁₁ H ₁₉ O ₂) ₃ ; FW: 664.63; white to off-white pwdr.; m.p. 167°	1g 5g
---------	--	----------

IODINE (Compounds)

93-5302	Iodine(V) oxide, 99% (12029-98-0)	10g
HAZ	I ₂ O ₅ ; FW: 333.81; white pwdr.; m.p. 300-350° dec.; d. 4.799 <i>hygroscopic</i>	50g

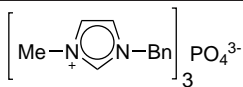
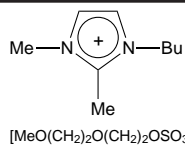
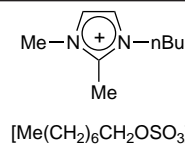
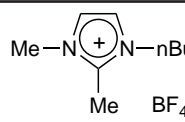
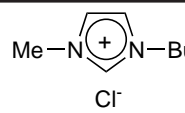
IONIC LIQUIDS (Compounds)

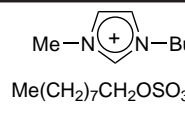
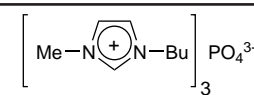
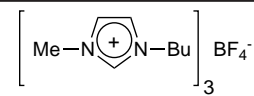
07-0090	1-Benzyl-3-methylimidazolium phosphate, 99% [C ₁₁ H ₁₃ N ₂] ₃ PO ₄ ⁻ ; FW: 614.68; clear, brown liq.		5g
07-0050	1-Butyl-2,3-dimethylimidazolium diethylene-glycolmonomethylether sulfate, 98% [BDiMIM] [MDEGSO ₄] (108203-89-0) [C ₉ H ₁₇ N ₂] ⁺ [CH ₃ O(CH ₂) ₂ O(CH ₂) ₂ OSO ₃] ₃ ⁻ ; FW: 352.45; orange-brown liq.		5g
07-0060	1-Butyl-2,3-dimethylimidazolium octylsulfate, 98% [BDiMIM] [OcSO ₄] (108203-89-0) [C ₉ H ₁₇ N ₂] ⁺ [CH ₃ (CH ₂) ₆ CH ₂ OSO ₃] ₃ ⁻ ; FW: 362.53; white to off-white pwdr.		5g
07-0075	1-Butyl-2,3-dimethylimidazolium tetrafluoroborate, 98% [BDiMIM] [BF ₄] ⁻ (402846-78-0) [C ₉ H ₁₇ N ₂] ⁺ BF ₄ ⁻ ; FW: 240.05; pale yellow liq.; d. 1.198		5g
07-0100	1-Butyl-3-methylimidazolium chloride, 98% [BMIM]Cl (79917-90-1) [C ₈ H ₁₅ N ₂] ⁺ Cl ⁻ ; FW: 174.67; white to off-white solid; m.p. 65° <i>hygroscopic</i> Note: BMIM Ionic Liquid Kit 2 component.		10g
07-0140	1-Butyl-3-methylimidazolium methanesulfonate, 98% [BMIM] [MeSO ₄] (401788-98-5) [C ₈ H ₁₅ N ₂] ⁺ [CH ₃ OSO ₃] ₃ ⁻ ; FW: 250.32; yellow liq.; d. 1.21 <i>hygroscopic</i> Note: BMIM Ionic Liquid Kit 2 component.		5g
07-0150	1-Butyl-3-methylimidazolium octylsulfate, 98% [BMIM] [OctSO ₄] (445473-58-5) [C ₈ H ₁₅ N ₂] ⁺ [CH ₃ (CH ₂) ₇ OSO ₃] ₃ ⁻ ; FW: 348.51; beige solid; m.p. 37° <i>hygroscopic</i> Note: BMIM Ionic Liquid Kit 2 component.		5g
07-0160	1-Butyl-3-methylimidazolium phosphate, 99% [BMIM] ₃ [PO ₄] ⁻ [C ₈ H ₁₅ N ₂] ₃ PO ₄ ⁻ ; FW: 512.63; pale yellow liq. Note: BMIM Ionic Liquid Kit 2 component.		5g
07-0170	1-Butyl-3-methylimidazolium tetrafluoroborate, 98% [BMIM] [BF ₄] ⁻ (174501-65-6) [C ₈ H ₁₅ N ₂] ⁺ BF ₄ ⁻ ; FW: 226.03; yellow liq.; m.p. -75°; d. 1.21 <i>hygroscopic</i> Note: BMIM Ionic Liquid Kit 2 component.		5g

IONIC LIQUIDS (Compounds)

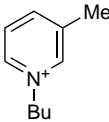
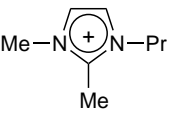
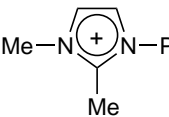
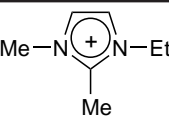
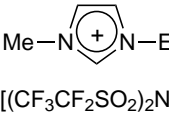
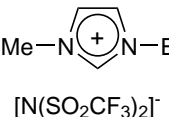
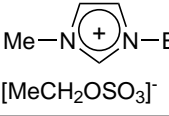
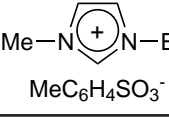
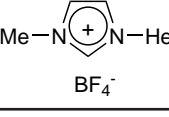
07-0180	N-Butyl-3-methylpyridinium bis(trifluoromethylsulfonyl) imide, 99% [BMPIm] (344790-86-9) [C ₁₁ H ₁₆ N] ⁺ [N(SO ₂ CF ₃) ₂] ⁻ ; FW: 442.40; colorless to pale yellow liq.; d. 1.40 Note: Product protected by U.S. Patent 5,827,602 assigned to Covalent Associates, Inc. Hydrophobic (water-immiscible) Ionic Liquid Kit 1 component.	 [N(SO ₂ CF ₃) ₂] ⁻	1g 5g
07-0465	1,2-Dimethyl-3-propylimidazolium bis(trifluoromethylsulfonyl)imide, 99% [DMPIm] (169051-76-7) [C ₈ H ₁₅ N ₂] ⁺ [N(SO ₂ CF ₃) ₂] ⁻ ; FW: 419.37; colorless to pale yellow liq.; d. 1.47 Note: Product protected by U.S. Patent 5,827,602 assigned to Covalent Associates, Inc. Hydrophobic (water-immiscible) Ionic Liquid Kit 1 component.	 [NH(SO ₂ CF ₃) ₂] ⁻	1g 5g
07-0470	1,2-Dimethyl-3-propylimidazolium tris(trifluoromethylsulfonyl)methide, 99% [DMPiMe] (169051-77-8) [C ₈ H ₁₅ N ₂] ⁺ [C(SO ₂ CF ₃) ₃] ⁻ ; FW: 550.44; colorless to pale yellow liq.; d. 1.52 Note: Product protected by U.S. Patent 5,827,602 assigned to Covalent Associates, Inc. Hydrophobic (water-immiscible) Ionic Liquid Kit 1 component.	 (CF ₃ SO ₂) ₃ C ⁻	500mg 2g
07-0535	1-Ethyl-2,3-dimethylimidazolium tosylate, 98% [ED-iMIM] [TOS] (783321-71-1) [C ₇ H ₁₃ N ₂] ⁺ [CH ₃ C ₆ H ₄ SO ₃] ⁻ ; FW: 296.38; white to off-white powdr.	 CH ₃ C ₆ H ₄ SO ₃ ⁻	5g
07-0578	1-Ethyl-3-methylimidazolium bis(pentafluoroethylsulfonyl)imide, 99% [EMIBeti] (216299-76-2) [C ₈ H ₁₁ N ₂] ⁺ [N(SO ₂ CF ₂ CF ₃) ₂] ⁻ ; FW: 491.33; colorless to pale yellow liq.; d. 1.57 Note: Product protected by U.S. Patent 5,827,602 assigned to Covalent Associates, Inc. Hydrophobic (water-immiscible) Ionic Liquid Kit 1 component.	 [(CF ₃ CF ₂ SO ₂) ₂ N] ⁻	500mg 2g
07-0579	1-Ethyl-3-methylimidazolium bis(trifluoromethylsulfonyl)imide, 99% [EMiIm] (174899-82-2) [C ₈ H ₁₁ N ₂] ⁺ [N(SO ₂ CF ₃) ₂] ⁻ ; FW: 391.31; colorless to pale yellow liq.; d. 1.53 Note: Product protected by U.S. Patent 5,827,602 assigned to Covalent Associates, Inc. Hydrophobic (water-immiscible) Ionic Liquid Kit 1 component.	 [N(SO ₂ CF ₃) ₂] ⁻	1g 5g
07-0581	1-Ethyl-3-methylimidazolium ethylsulfate, 98% (342573-75-5) [C ₈ H ₁₁ N ₂] ⁺ [CH ₃ CH ₂ OSO ₃] ⁻ ; FW: 236.29; colorless liq.; m.p. <65°; d. 1.2285 Note: Halogen free ionic liquid.	 [MeCH ₂ OSO ₃] ⁻	10g 50g 250g
07-0588	1-Ethyl-3-methylimidazolium tosylate, 98% [EMIM] [TOS] (328090-25-1) [C ₈ H ₁₁ N ₂] ⁺ [CH ₃ C ₆ H ₄ SO ₃] ⁻ ; FW: 282.35; off-white solid; m.p. 32° <i>hygroscopic</i>	 MeC ₆ H ₄ SO ₃ ⁻	5g
07-0968	1-Hexyl-3-methylimidazolium tetrafluoroborate, 98% [HMIM] [BF₄] (244193-50-8) [C ₁₀ H ₁₉ N ₂] ⁺ BF ₄ ⁻ ; FW: 254.08; yellow liq.; m.p. -81°; d. 1.149 <i>hygroscopic</i>	 BF ₄ ⁻	5g
96-6510	Ionic Liquid Kit 2: BMIM Kit See page 499		

IONIC LIQUIDS (Compounds)

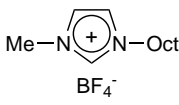
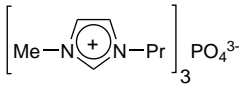
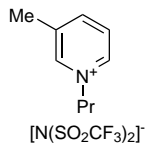
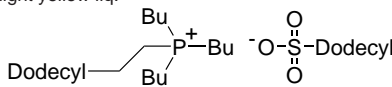
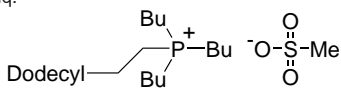
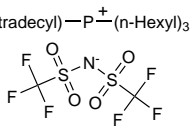
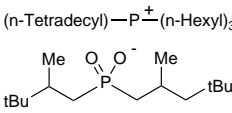
96-6520	Ionic Liquid Kit 3: CYPHOS® IL Phosphonium Salt Kit See page 499		
96-6500	Ionic Liquid Kit 1: Hydrophobic (water-immiscible) Kit See page 498		
07-1264	1-Methyl-3-octylimidazolium tetrafluoroborate, 98% [OMIM] [BF₄] (244193-52-0) [C ₁₂ H ₂₃ N ₂] ⁺ BF ₄ ⁻ ; FW: 282.13; yellow liq.; m.p. -88°; d. 1.12 <i>hygroscopic</i>		5g
07-1725	1-Methyl-3-propylimidazolium phosphate, 99% (817575-04-5) [C ₇ H ₁₃ N ₂] ₃ PO ₄ ³⁻ ; FW: 470.55; clear, brown liq.		5g
07-1775	N-Propyl-3-methylpyridinium bis(trifluoromethylsulfonyl) imide, 99% [PMPIm] (817575-06-7) [C ₇ H ₁₄ N] ⁺ [N(SO ₂ CF ₃) ₂] ₂ ⁻ ; FW: 380.33; colorless to pale yellow liq.; m.p. 0°; d. 1.44 Note: Product protected by U.S. Patent 5,827,602 assigned to Covalent Associates, Inc. Hydrophobic (water-immiscible) Ionic Liquid Kit 1 component.		1g 5g
15-1322	Tetraoctylphosphonium bromide, min. 95% (23906-97-0) C ₃₂ H ₆₈ BrP; FW: 563.76; white to yellow, waxy solid <i>hygroscopic</i>		5g 25g
15-1330	Tributyl(ethyl)phosphonium diethylphosphate, 95% (20445-94-7) C ₁₈ H ₄₂ O ₄ P ₂ ; FW: 384.47; colorless to pale-yellow liq.; d. 1.007 <i>hygroscopic</i>		5g 25g
15-1327 HAZ	Tributyl(methyl)phosphonium methylsulfate, min. 95% (69056-62-8) C ₁₄ H ₃₃ O ₂ PS; FW: 328.18; white solid to pale-yellow liq.		5g 25g
15-1324	Tri-<i>i</i>-butyl(methyl)phosphonium tosylate, min. 95% (374683-35-9) C ₂₀ H ₃₇ O ₃ PS; FW: 388.54; white to yellow, waxy solid; d. 1.1		5g 25g
15-5960	Tributyl(tetradecyl)phosphonium dodecylbenzenesulfonate, min. 98% CYPHOS® IL 201 [(C ₄ H ₉) ₃ (C ₁₄ H ₂₉)P] ⁺ [(C ₁₂ H ₂₅ C ₆ H ₄ SO ₃) ₂] ⁻ ; FW: 725.18; light yellow liq.		10g 50g
15-5970	Tributyl(tetradecyl)phosphonium methanesulfonate, min. 98% CYPHOS® IL 203 [(C ₄ H ₉) ₃ (C ₁₄ H ₂₉)P] ⁺ CH ₃ SO ₃ ⁻ ; FW: 494.80; light yellow liq.		10g 50g
15-6370	Trihexyl(tetradecyl)phosphonium bis(trifluoromethanesulfonyl)amide, min. 97% CYPHOS® IL 109 (460092-03-9) [(C ₆ H ₁₃) ₃ (C ₁₄ H ₂₉)P] ⁺ [(CF ₃ SO ₂) ₂ N] ⁻ ; FW: 764.00; colorless liq. Note: CYPHOS® IL Phosphonium Salt Ionic Liquid Kit 3 component.		10g 50g
15-6374	Trihexyl(tetradecyl)phosphonium bis(2,4,4-trimethylpentyl)phosphinate, min. 95% CYPHOS® IL 104 (465527-59-7) [(C ₆ H ₁₃) ₃ (C ₁₄ H ₂₉)P] ⁺ [[CH(CH ₃) ₃ CCH ₂ CH(CH ₃)CH ₂] ₂ P(O)O] ⁻ ; FW: 773.27; pale yellow liq.; d. 0.887 Note: CYPHOS® IL Phosphonium Salt Ionic Liquid Kit 3 component.		10g 50g

IONIC LIQUIDS (Compounds)

15-6378	Trihexyl(tetradecyl)phosphonium bromide, min. 95% CYPHOS® IL 102 (654057-97-3) [(C ₆ H ₁₃) ₃ (C ₁₄ H ₂₉)P] ⁺ Br ⁻ ; FW: 563.76; pale yellow liq.; d. 0.952 Note: CYPHOS® IL Phosphonium Salt Ionic Liquid Kit 3 component.	10g 50g
15-6382	Trihexyl(tetradecyl)phosphonium chloride, min. 93% CYPHOS® IL 101 (258864-54-9) [(C ₆ H ₁₃) ₃ (C ₁₄ H ₂₉)P] ⁺ Cl ⁻ ; FW: 519.31; colorless liq.; d. 0.894 Note: CYPHOS® IL Phosphonium Salt Ionic Liquid Kit 3 component.	10g 50g
15-6386	Trihexyl(tetradecyl)phosphonium decanoate, min. 95% CYPHOS® IL 103 (465527-65-5) [(C ₆ H ₁₃) ₃ (C ₁₄ H ₂₉)P] ⁺ [CH ₃ (CH ₂) ₈ COO] ⁻ ; FW: 655.11; pale yellow semi solid; m.p. 24°; d. 0.883 Note: CYPHOS® IL Phosphonium Salt Ionic Liquid Kit 3 component.	10g 50g
15-6390	Trihexyl(tetradecyl)phosphonium dicyanamide, min. 95% CYPHOS® IL 105 [(C ₆ H ₁₃) ₃ (C ₁₄ H ₂₉)P] ⁺ [NCNHCN] ⁻ ; FW: 550.91; pale yellow liq. Note: CYPHOS® IL Phosphonium Salt Ionic Liquid Kit 3 component.	10g 50g
15-6394	Trihexyl(tetradecyl)phosphonium hexafluorophosphate, min. 98% CYPHOS® IL 110 (374683-44-0) [(C ₆ H ₁₃) ₃ (C ₁₄ H ₂₉)P] ⁺ PF ₆ ⁻ ; FW: 628.82; white solid; m.p. 50°; d. 1.013 Note: CYPHOS® IL Phosphonium Salt Ionic Liquid Kit 3 component.	10g 50g
07-2660	1,2,3-Trimethylimidazolium methyl sulfate, 98% [TriMIM][MeSO ₄] (65086-12-6) [C ₆ H ₁₁ N ₂] ⁺ [CH ₃ SO ₃] ⁻ ; FW: 222.27; tan pwdr.; m.p. 115°	5g

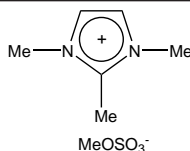
**IRIDIUM (Elemental Forms)**

77-2000 HAZ	Iridium black (99.9% Ir) (7439-88-5) Ir; FW: 192.22; 30-60 m ² /g; m.p. 2410°; b.p. 4130°; d. 22.421	500mg 2g
77-2090	Iridium foil (99.8%) (7439-88-5) Ir; FW: 192.20; 0.25mm thick (~3.5g/25 x25mm); m.p. 2410°; b.p. 4130°; d. 22.421	25 x 25mm 50 x 50mm
77-2500 HAZ	Iridium powder (99.8%) (7439-88-5) Ir; FW: 192.20; bluish-gray pwdr.; m.p. 2410°; b.p. 4130°; d. 22.421	500mg 2g
77-2580 HAZ	Iridium sponge (99.95%) (7439-88-5) Ir; FW: 192.20; -20 mesh bluish-gray pwdr.; m.p. 2410°; b.p. 4130°; d. 22.421	500mg 2g
77-2700	Iridium wire (99.7%) (7439-88-5) Ir; FW: 192.20; 0.127mm dia. (~0.3g/m); m.p. 2410°; b.p. 4130°; d. 22.421	10cm 50cm

IRIDIUM (Compounds)

77-5030	{1-[(4R)-2-(1-Adamantyl-4,5-dihydrooxazolyl)ethyl]-3-(2,6-di-i-propylphenyl)imidazolin-2-ylidene} (1,5-cyclooctadiene)iridium(I) tetrakis[3,5-bis(trifluoromethyl)phenyl]borate, 99% (934621-82-6) C ₇₀ H ₆₇ BF ₂₄ IrN ₃ O; FW: 1623.27; orange solid For detailed technical note visit strem.com .	50mg 250mg
77-5031	{1-[(4S)-2-(1-Adamantyl-4,5-dihydrooxazolyl)ethyl]-3-(2,6-di-i-propylphenyl)imidazolin-2-ylidene} (1,5-cyclooctadiene)iridium(I) tetrakis[3,5-bis(trifluoromethyl)phenyl]borate, 99% (369657-32-9) C ₇₀ H ₆₅ BF ₂₄ IrN ₃ O; FW: 1623.27; orange solid For detailed technical note visit strem.com .	50mg 250mg
77-0019	Ammonium hexachloroiridate(III) hydrate (~39% Ir) (15752-05-3) See page 5	
77-0020	Ammonium hexachloroiridate(IV), 99% (16940-92-4) See page 5	

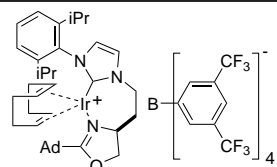
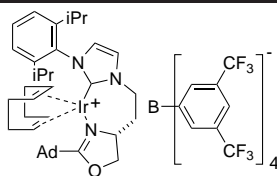

IRIDIUM (Compounds)

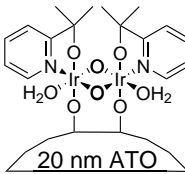
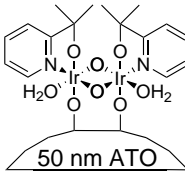
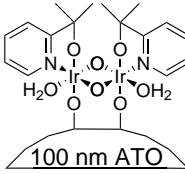
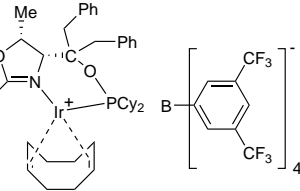
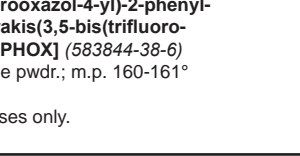
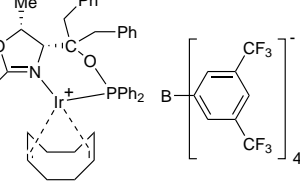
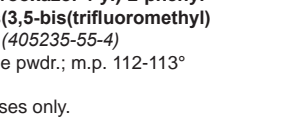
77-0030 NEW	Antimony Tin Oxide/Iridium Het-WOC core/shell nanopowder, 20 nm (conductive and acid-stable) blue powdr. Note: Sold under license from Catalytic Innovations, LLC for research purposes only. US Patent Publication No. US20150021194 A1. For detailed technical note visit strem.com .		250mg 1g
77-0035 NEW	Antimony Tin Oxide/Iridium Het-WOC core/shell nanopowder, 50 nm (conductive and acid-stable) blue powdr. Note: Sold under license from Catalytic Innovations, LLC for research purposes only. US Patent Publication No. US20150021194 A1. For detailed technical note visit strem.com .		250mg 1g
77-0040 NEW	Antimony Tin Oxide/Iridium Het-WOC core/shell nanopowder, 100 nm (conductive and acid-stable) blue powdr. Note: Sold under license from Catalytic Innovations, LLC for research purposes only. US Patent Publication No. US20150021194 A1. For detailed technical note visit strem.com .		250mg 1g
77-5009	((4R,5R)-(+)-O-[1-Benzyl-1-(5-methyl-2-phenyl-4,5-dihydrooxazol-4-yl)-2-phenylethyl] (dicyclohexylphosphinite)(1,5-COD)iridium(I) tetrakis(3,5-bis(trifluoromethyl)phenyl)borate, min. 97% (R,R)-[COD]Ir[cy₂PThrePHOX] (880262-14-6) $\text{Ir}(\text{C}_8\text{H}_{12})(\text{C}_{37}\text{H}_{48}\text{NO}_2\text{P})\cdot\text{B}[\text{C}_6\text{H}_3(\text{CF}_3)_2]_4$; FW: 1731.35; orange powdr.; m.p. 160-161° <i>air sensitive, moisture sensitive, (store cold)</i> Note: Sold in collaboration with Solvias for research purposes only. For detailed technical note visit strem.com .		100mg 500mg 2g 10g
77-5010	((4S,5S)-(-)-O-[1-Benzyl-1-(5-methyl-2-phenyl-4,5-dihydrooxazol-4-yl)-2-phenylethyl]-dicyclohexylphosphinite)(1,5-COD)iridium(I) tetrakis(3,5-bis(trifluoromethyl)phenyl)borate, min. 97% (S,S)-[COD]Ir[cy₂PThrePHOX] (583844-38-6) $\text{Ir}(\text{C}_8\text{H}_{12})(\text{C}_{37}\text{H}_{48}\text{NO}_2\text{P})\cdot\text{B}[\text{C}_6\text{H}_3(\text{CF}_3)_2]_4$; FW: 1731.35; orange powdr.; m.p. 160-161° <i>air sensitive, moisture sensitive, (store cold)</i> Note: Sold in collaboration with Solvias for research purposes only. For detailed technical note visit strem.com .		100mg 500mg 2g 10g
77-5019	((4R,5R)-(+)-O-[1-Benzyl-1-(5-methyl-2-phenyl-4,5-dihydrooxazol-4-yl)-2-phenylethyl] (diphenylphosphinite)(1,5-COD)iridium(I) tetrakis(3,5-bis(trifluoromethyl)phenyl)borate, min. 97% (R,R)-[COD]Ir[Ph₂PThrePHOX] (880262-16-8) $\text{Ir}(\text{C}_8\text{H}_{12})(\text{C}_{37}\text{H}_{34}\text{NO}_2\text{P})\cdot\text{B}[\text{C}_6\text{H}_3(\text{CF}_3)_2]_4$; FW: 1719.25; orange powdr.; m.p. 112-113° <i>air sensitive, (store cold)</i> Note: Sold in collaboration with Solvias for research purposes only. For detailed technical note visit strem.com .		100mg 500mg 2g 10g
77-5020	((4S,5S)-(-)-O-[1-Benzyl-1-(5-methyl-2-phenyl-4,5-dihydrooxazol-4-yl)-2-phenylethyl]-diphenylphosphinite)(1,5-COD)iridium(I) tetrakis(3,5-bis(trifluoromethyl)phenyl)borate, min. 97% (S,S)-[COD]Ir[Ph₂PThrePHOX] (405235-55-4) $\text{Ir}(\text{C}_8\text{H}_{12})(\text{C}_{37}\text{H}_{34}\text{NO}_2\text{P})\cdot\text{B}[\text{C}_6\text{H}_3(\text{CF}_3)_2]_4$; FW: 1719.25; orange powdr.; m.p. 112-113° <i>air sensitive, (store cold)</i> Note: Sold in collaboration with Solvias for research purposes only. For detailed technical note visit strem.com .		100mg 500mg 2g 10g

IRIDIUM (Compounds)

77-0220 NEW	(2,2'-Bipyridine)bis[3,5-difluoro-2-[5-(trifluoromethyl)-2-pyridinyl-kN][phenyl-kC]iridium(III) hexafluorophosphate, 95% (1092775-62-6) $C_{34}H_{18}F_{16}IrN_4P$; FW: 1009.70; yellow powd. <i>air sensitive</i> Note: Photocatalyst For detailed technical note visit strem.com .		50mg 250mg
77-0465 NEW	(2,2'-Bipyridine)bis[2-pyridinyl-kN]phenyl-kC]iridium(III) hexafluorophosphate, 99% (106294-60-4) $[Ir(C_{10}H_8N_2)(C_{11}H_8N_2)_2]PF_6$; FW: 801.74; yellow powd. Note: Photocatalyst For detailed technical note visit strem.com .		100mg 500mg
77-0213	Bis(acetonitrile)(1,5-cyclooctadiene)iridium(I) tetrafluoroborate, min. 97% (32679-03-1) $[Ir(C_8H_{12})(CH_3CN)_2]BF_4$; FW: 469.31; yellow powd. <i>air sensitive</i>		250mg 1g
77-0218 NEW	4,4'-Bis(t-butyl-2,2'-bipyridine)bis[5-methyl-2-(4-methyl-2-pyridinyl-kN)phenyl-kC]iridium hexafluorophosphate, 95% (1607469-49-7) $C_{44}H_{48}F_6IrN_4P$; FW: 970.06; yellow powd. <i>air sensitive</i> Note: Photocatalyst For detailed technical note visit strem.com .		50mg 250mg
77-0200	Bis(1,5-cyclooctadiene)iridium(I) tetrafluoroborate, 98% (35138-23-9) $Ir(C_8H_{12})_2^+BF_4^-$; FW: 495.40; dark red xtl. <i>air sensitive, (store cold)</i>		100mg 500mg 2g
77-0225	Bis(1,5-cyclooctadiene)iridium(I) tetrakis[3,5-bis(trifluoromethyl)phenyl] borate, 98% (666826-16-0) $Ir(C_8H_{12})_2^+[B(C_6H_3F_3)_4]^-$; FW: 1271.80; black xtl. For detailed technical note visit strem.com .		100mg 500mg
77-5074	[(R)-(+)-5,5'-Bis(diphenylphosphino)-4,4'-bi-1,3-benzodioxole][4-cyano-3-nitrobenzenecarboxylato][1,2,3-η-2-propenyl]iridium(III), min. 97% (1208092-27-6) $C_{49}H_{35}IrN_2O_8P_2$; FW: 1033.98; yellow powd. Note: Manufactured under license of Takasago patent. For detailed technical note visit strem.com .		100mg 500mg
77-5075	[(S)-(-)-5,5'-Bis(diphenylphosphino)-4,4'-bi-1,3-benzodioxole][4-cyano-3-nitrobenzenecarboxylato][1,2,3-η-2-propenyl]iridium(III), min. 97% (1221768-92-8) $C_{49}H_{35}IrN_2O_8P_2$; FW: 1033.98; yellow powd. Note: Manufactured under license of Takasago patent. For detailed technical note visit strem.com .		100mg 500mg

IRIDIUM (Compounds)

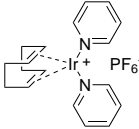
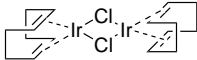
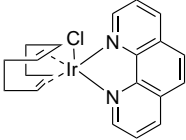
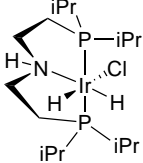
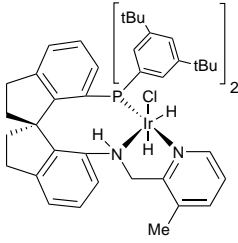
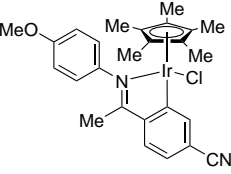
77-0440 NEW	Bis(pyridine)(1,5-cyclooctadiene)iridium(I) hexafluorophosphate, 99% (56678-60-5) (C ₈ H ₈ N) ₂ (C ₈ H ₁₂)Ir ₅ PF ₆ ⁻ ; FW: 603.56; orange powd. <i>air sensitive</i> For detailed technical note visit strem.com .		250mg 1g
96-7650	CATHy™ Catalyst Kit for Asymmetric Transfer Hydrogenation of Ketones and Imines See page 476		
77-0250	Chlorobis(cyclooctene)iridium(I) dimer, 97% (12246-51-4) [IrCl(C ₈ H ₁₄) ₂] ₂ ; FW: 896.13; yellow xtl. <i>moisture sensitive, (store cold)</i>		250mg 1g 5g
77-0300	Chlorocarbonylbis(triphenylphosphine)iridium(I), 99% VASKA'S COMPLEX (14871-41-1) IrCl(CO)[(C ₆ H ₅) ₃ P] ₂ ; FW: 780.27; lemon yellow xtl.		250mg 1g 5g
77-0400	Chloro-1,5-cyclooctadiene iridium(I) dimer, 99% (12112-67-3) [IrCl(C ₈ H ₁₂) ₂]; FW: 671.71; red to orange powd.; m.p. 190° dec. For detailed technical note visit strem.com .		500mg 2g 10g
77-0258 NEW	Chloro(1,5-cyclooctadiene)(1,10-phenanthroline)iridium(I) THF adduct, min. 98% (41396-69-4) C ₂₀ H ₂₀ ClIrN ₂ ; FW: 516.05; purple solid <i>air sensitive</i> For detailed technical note visit strem.com .		250mg 1g 5g
77-0500	Chlorodihydrido[bis(2-di-i-propylphosphinoethyl)amine]iridium(III), min. 98% (791629-96-4) IrClH ₂ (C ₁₈ H ₃₇ NP ₂); FW: 535.10; white powd. Note: Sold under license from Kanata for research purposes only. Patent WO04096735; US 10/985,058. For detailed technical note visit strem.com .		250mg 1g
77-4035 NEW	Chlorodihydrido{(R)-(+)-7-Bis(3,5-di-t-butylphenyl)phosphino-7'-[(3-methylpyridine-2-ylmethyl)amino]-2,2',3,3'-tetrahydro-1,1'-spirobiindane}iridium(III), >97% (>99% ee) Ir-(R)-DTB-SpiroPAP-3-Me (1396201-63-0) C ₅₂ H ₆₇ ClIrN ₂ P; FW: 978.75; yellow-green solid For detailed technical note visit strem.com .		25mg 100mg
77-4036 NEW	Chlorodihydrido{(S)-(-)-7-Bis(3,5-di-t-butylphenyl)phosphino-7'-[(3-methylpyridine-2-ylmethyl)amino]-2,2',3,3'-tetrahydro-1,1'-spirobiindane}iridium(III), >97% (>99% ee) Ir-(S)-DTB-SpiroPAP-3-Me (1418483-59-6) C ₅₂ H ₆₇ ClIrN ₂ P; FW: 978.75; yellow-green solid		25mg 100mg
Technical Note: 1. See 77-4035 (page 87)			
77-0424	Chloro(pentamethylcyclopentadienyl){5-cyano-2-[1-[(4-methoxyphenyl)imino-kN]ethyl]phenyl-kC}iridium(III), 99% Iridicycle-CN (1258964-46-3) C ₂₆ H ₂₈ ClIrN ₂ O; FW: 612.18; red powd. Note: Sold in collaboration with Yorkshire Process Technology for research purposes only. Developed by Prof. J. Xiao, Liverpool University. Patents GB 1206572.8 and GB 1206573.6 Iridicycle Catalyst Kit component. For detailed technical note visit strem.com .		100mg 500mg

IRIDIUM (Compounds)

77-0418	Chloro(pentamethylcyclopentadienyl) {5-methoxy-2-[1-[(4-methoxyphenyl)imino-kN]ethyl]phenyl-kC}iridium(III), 99% Iridicycle-MeO (1258964-48-5) $C_{26}H_{31}ClIrNO_2$; FW: 617.20; orange powdr. Note: Sold in collaboration with Yorkshire Process Technology for research purposes only. Developed by Prof. J. Xiao, Liverpool University. Patents GB 1206572.8 and GB 1206573.6 Iridicycle Catalyst Kit component. For detailed technical note visit strem.com .		100mg 500mg
77-0428	Chloro(pentamethylcyclopentadienyl) {2-[1-[(4-methoxyphenyl)imino-kN]ethyl]naphthyl-kC}iridium(III), 99% Iridicycle-Naphth (1469467-94-4) $C_{28}H_{31}ClIrNO$; FW: 632.23; red-orange powdr. Note: Sold in collaboration with Yorkshire Process Technology for research purposes only. Developed by Prof. J. Xiao, Liverpool University. Patents GB 1206572.8 and GB 1206573.6 Iridicycle Catalyst Kit component. For detailed technical note visit strem.com .		100mg 500mg
77-0430	Chloro(pentamethylcyclopentadienyl){5-nitro-2-[1-[(4-methoxyphenyl)imino-kN]ethyl]phenyl-kC}iridium(III), 99% Iridicycle-NO2 (1439402-25-1) $C_{26}H_{28}ClIrN_2O_3$; FW: 632.17; brown powdr. Note: Sold in collaboration with Yorkshire Process Technology for research purposes only. Developed by Prof. J. Xiao, Liverpool University. Patents GB 1206572.8 and GB 1206573.6 Iridicycle Catalyst Kit component. For detailed technical note visit strem.com .		100mg 500mg
77-0650	Chloro(pentamethylcyclopentadienyl)[(2-pyridinyl-kN)phenyl-kC]iridium(III), 99% (945491-51-0) $IrCl(C_{10}H_{13})(C_{11}H_8N)$; FW: 517.08; orange powdr.		100mg 500mg

Technical Notes:

1. Highly active catalyst for water oxidation.
2. Catalyst for the hydrosilylation of imines.
3. Catalyst for C-H oxidation.

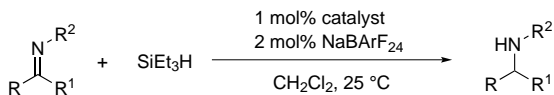

Tech. Note (2)
Ref. (2)

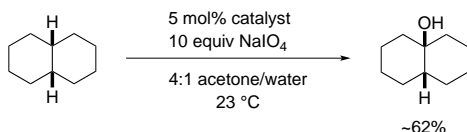

Tech. Note (3)
Ref. (3)

References:

1. *J. Am. Chem. Soc.*, **2009**, *131*, 8730.
2. *Catal. Sci. Technol.* **2015**, *5*, 1452.
3. *Organometallics*, **2015**, *32*, 957.

77-0900	1,5-Cyclooctadiene(acetylacetonato)iridium(I), 99% (99.9%-Ir) (12154-84-6) $Ir(C_8H_{12})(C_5H_7O_2)$; FW: 399.49; yellow xtl.; m.p. 145-150° dec.	100mg 500mg
---------	---	----------------

Technical Note:

1. Convenient precursor to a variety of Iridium complexes and catalysts.

IRIDIUM (Compounds)

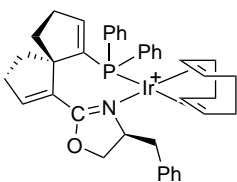
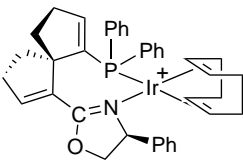
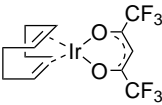
77-5041	<p>1,5-Cyclooctadiene((4S)-(-)-2-[(5R)-6-(diphenylphosphino)spiro[4.4]nona-1.6-dien-1-yl]-4,5-dihydro-4-benzoyloxazole}iridium(I) tetrakis[3,5-bis(trifluoromethyl)phenyl]borate, 97% (R,S)-(COD)Ir[Bn-SpinPHOX] (1195511-56-8) C₃₉H₄₂IrNOP(C₃₂H₁₂BF₂₄); FW: 1627.16; red powdr.; m.p. 103-105° <i>air sensitive</i> Note: Sold in collaboration with SIOC for research purposes only. Patents CN200910051314.3, CN 101555259. SpinPHOX-Ir Catalyst Kit component.</p>	 <p style="text-align: center;">B[C₆H₃(CF₃)₂]₄⁻</p>	25mg 100mg
77-5040	<p>1,5-Cyclooctadiene((4S)-(+)-2-[(5S)-6-(diphenylphosphino)spiro[4.4]nona-1.6-dien-1-yl]-4,5-dihydro-4-benzoyloxazole}iridium(I) tetrakis[3,5-bis(trifluoromethyl)phenyl]borate, 97% (S,S)-(COD)Ir[Bn-SpinPHOX] (1194050-19-5) C₃₉H₄₂IrNOP(C₃₂H₁₂BF₂₄); FW: 1627.16; red solid; m.p. 49-51° <i>air sensitive</i> Note: Sold in collaboration with SIOC for research purposes only. Patents CN200910051314.3, CN 101555259. SpinPHOX-Ir Catalyst Kit component. For detailed technical note visit strem.com.</p>	25mg 100mg	
77-5046	<p>1,5-Cyclooctadiene((4S)-(+)-2-[(5S)-6-(diphenylphosphino)spiro[4.4]nona-1.6-dien-1-yl]-4,5-dihydro-4-phenyloxazole}iridium(I) tetrakis[3,5-bis(trifluoromethyl)phenyl]borate, 97% (S,S)-(COD)Ir[Ph-SpinPHOX] (1194050-21-9) C₃₈H₄₀IrNOP(C₃₂H₁₂BF₂₄); FW: 1613.13; orange powdr.; m.p. 197-198° <i>air sensitive</i> Note: Sold in collaboration with SIOC for research purposes only. Patents CN200910051314.3, CN 101555259. SpinPHOX-Ir Catalyst Kit component.</p>	25mg 100mg	
Technical Note:			
1. See 77-5047 (page 89)			
77-5047	<p>1,5-Cyclooctadiene((4S)-(-)-2-[(5R)-6-(diphenylphosphino)spiro[4.4]nona-1.6-dien-1-yl]-4,5-dihydro-4-phenyloxazole}iridium(I) tetrakis[3,5-bis(trifluoromethyl)phenyl]borate, 97% (R,S)-(COD)Ir[Ph-SpinPHOX] (1195511-59-1) C₃₈H₄₀IrNOP(C₃₂H₁₂BF₂₄); FW: 1613.13; red powdr.; m.p. 172-174° <i>air sensitive</i> Note: Sold in collaboration with SIOC for research purposes only. Patents CN200910051314.3, CN 101555259. SpinPHOX-Ir Catalyst Kit component.</p>	 <p style="text-align: center;">B[C₆H₃(CF₃)₂]₄⁻</p>	25mg 100mg
77-5050	<p>1,5-Cyclooctadiene((4S)-(+)-2-[(5S)-6-(diphenylphosphino)spiro[4.4]nona-1.6-dien-1-yl]-4,5-dihydro-4-(i-propyl)oxazole}iridium(I) tetrakis[3,5-bis(trifluoromethyl)phenyl]borate, 97% (S,S)-(COD)Ir[iPr-SpinPHOX] (1194050-23-1) C₃₉H₄₂IrNOP(C₃₂H₁₂BF₂₄); FW: 1579.11; red-orange powdr.; m.p. 201-203° <i>air sensitive</i> Note: Sold in collaboration with SIOC for research purposes only. Patents CN200910051314.3, CN 101555259. SpinPHOX-Ir Catalyst Kit component. For detailed technical note visit strem.com.</p>	25mg 100mg	
77-0930	<p>1,5-Cyclooctadiene(hexafluoroacetylacetonato)iridium(I), 98% (34801-95-1) Ir(C₈H₁₂)(C₅HF₆O₂); FW: 507.45; red-purple xtl. For detailed technical note visit strem.com.</p>		100mg 500mg

IRIDIUM (Compounds)

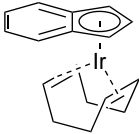
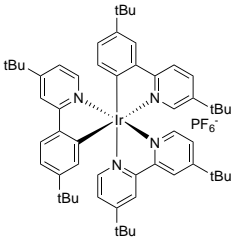
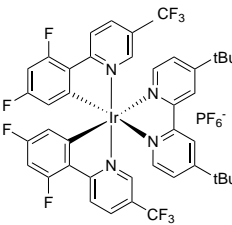
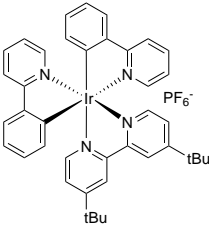
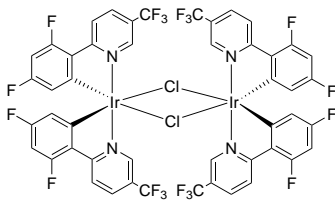
77-0950	1,5-Cyclooctadiene(η^5-indenyl)iridium(I), 99% (102525-11-1) C ₁₇ H ₁₉ Ir; FW: 415.55; yellow xtl. For detailed technical note visit strem.com .		250mg 1g
77-0285 NEW	[4,4'-Di-t-butyl-2,2'-bipyridine][bis[5-(t-butyl)-2-[4-(t-butyl)-2-pyridinyl-kN]phenyl-kC]iridium(III) hexafluorophosphate, 95% (808142-80-5) C ₅₆ H ₇₂ F ₆ IrN ₄ P; FW: 1138.38; yellow powder. <i>air sensitive</i> Note: Photocatalyst		50mg 250mg
77-0425 NEW	(4,4'-Di-t-butyl-2,2'-bipyridine)bis[3,5-difluoro-2-[5-trifluoromethyl-2-pyridinyl-kN]phenyl-kC]iridium(III) hexafluorophosphate, 99% (870987-63-6) [Ir(C ₁₈ H ₂₄ N ₂)(C ₁₂ H ₅ F ₃ N ₂) ₂] ⁺ PF ₆ ⁻ ; FW: 1121.91; yellow xtl. Note: Photocatalyst For detailed technical note visit strem.com .		50mg 250mg
77-0410 NEW	(4,4'-Di-t-butyl-2,2'-bipyridine)bis[2-(2-pyridinyl-kN)phenyl-kC]iridium(III) hexafluorophosphate, 99% (676525-77-2) [Ir(C ₁₈ H ₂₄ N ₂)(C ₁₁ H ₈ N ₂) ₂] ⁺ PF ₆ ⁻ ; FW: 913.95; yellow xtl. Note: Photocatalyst For detailed technical note visit strem.com .		100mg 500mg
77-1050	Dicarbonyl(acetylacetonato)iridium(I), 98% (14023-80-4) Ir(CO) ₂ (CH ₃ COCHCOCH ₃); FW: 347.35; copper brown xtl. (store cold)		100mg 500mg 2g
77-1060	Dichloro(pentamethylcyclopentadienyl)iridium(III) dimer, 98% (12354-84-6) [(CH ₃) ₅ C ₅ IrCl ₂] ₂ ; FW: 796.67; orange xtl. Note: CATHy™ Catalyst Kit component. For detailed technical note visit strem.com .		100mg 500mg 2g
77-0468 NEW	Di-μ-chlorotetrakis[3,5-difluoro-2-[5-trifluoromethyl-2-pyridinyl-kN]phenyl-kC]diiridium(III), 99% (870987-64-7) C ₄₈ H ₂₀ Cl ₂ F ₂₀ Ir ₂ N ₄ ; FW: 1488.01; yellow xtl. Note: Photocatalyst For detailed technical note visit strem.com .		50mg 250mg

IRIDIUM (Compounds)

77-0455	Di-μ-chlorotetrakis[2-(2-pyridinyl-kN)phenyl-kC] diiridium(III), 99% (603109-48-4) $C_{44}H_{32}Cl_2Ir_2N_4$; FW: 1072.09; yellow-green xtl. Note: Photocatalyst For detailed technical note visit strem.com .		250mg 1g
77-1090 HAZ	Dihydrogen hexachloroiridate(IV) hydrate (99.9%-Ir) (110802-84-1) $H_2IrCl_6 \cdot XH_2O$; FW: 407.00; black xtl. <i>hygroscopic</i>		1g 5g
77-1100	Di-μ-methoxobis(1,5-cyclooctadiene)diiridium(I), min. 98% (12148-71-9) $[Ir(OCH_3)(C_8H_{12})_2]_2$; FW: 662.86; yellow powder.		500mg 2g 10g
77-1830	(Dimethylphenylphosphine)(1,5-cyclooctadiene)[1,3-bis(2,4,6-trimethylphenyl)imidazol-2-ylidene]iridium(I) hexafluorophosphate, min. 98% (1019853-03-2) $[Ir(C_8H_{12})(C_{21}H_{24}N_2)(C_6H_{11}P)]^+PF_6^-$; FW: 887.93; red xtl. For detailed technical note visit strem.com .		100mg 500mg
77-1115	3-Di-<i>i</i>-propylphosphino-2-(N,N-dimethylamino)-1H-indene(1,5-cyclooctadiene)iridium(I) hexafluorophosphate, min. 98% (870077-94-4) $[IrC_{25}H_{38}NP] \cdot PF_6^-$; FW: 720.73; orange powder. For detailed technical note visit strem.com .		250mg 1g
77-2510	{(R)-(+)-7-[N-(1,3-Dithian-2-yl)methylamino]-7'-[bis(3,5-di-<i>t</i>-butylphenyl)phosphino]-2,2',3,3'-tetrahydro-1,1'-spirobindane}chlorodihydroiridium(III), 97+% [(R)-DTB-SpiroSAP] $C_{50}H_{68}ClIrNPS_2$; FW: 1005.86; pale yellow solid For detailed technical note visit strem.com .		25mg 100mg
77-2511	{{(S)-(-)-7-[N-(1,3-Dithian-2-yl)methylamino]-7'-[bis(3,5-di-<i>t</i>-butylphenyl)phosphino]-2,2',3,3'-tetrahydro-1,1'-spirobindane}chlorodihydroiridium(III), 97+% [(S)-DTB-SpiroSAP] $C_{50}H_{68}ClIrNPS_2$; FW: 1005.86; pale yellow solid		25mg 100mg
Technical Note:	1. See 77-2510 (page 91)		
77-1105	1-Ethylcyclopentadienyl-1,3-cyclohexadieneiridium(I), 99% (99.9%-Ir) (721427-58-3) $C_{13}H_{17}Ir$; FW: 365.49; pale yellow liq.		250mg 1g
77-1400	Hydridocarbonyltris(triphenylphosphine)iridium(I), 99% (17250-25-8) $IrH(CO)[(C_6H_5)_3P]_3$; FW: 1008.12; light yellow powder; m.p. 170° dec. <i>air sensitive</i> For detailed technical note visit strem.com .		1g 5g
96-3745	Iridicycle Catalyst Kit See page 486		

IRIDIUM (Compounds)

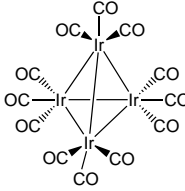
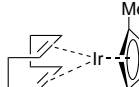
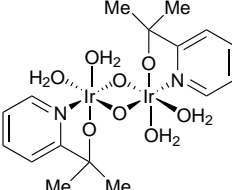
77-1500	Iridium(III) acetylacetonate, 98% (15635-87-7) Ir(CH ₃ COCHCOCH ₃) ₃ ; FW: 489.53; orange xtl.	250mg 1g 5g 25g
93-7728	Iridium(III) bromide tetrahydrate, 99% (13464-83-0) IrBr ₃ ·4H ₂ O; FW: 431.93 (503.99); black xtl.	500mg 2g
77-1800	Iridium carbonyl, min. 98% (11065-24-0) Ir ₄ (CO) ₁₂ ; FW: 1105.01; yellow powdr.; m.p. 230° dec.	250mg 1g 5g
		
93-7729	Iridium(III) chloride, anhydrous (99.95+%-Ir) (10025-83-9) IrCl ₃ ; FW: 298.58; black powdr.; m.p. 763° dec.; d. 5.30	500mg 2g
77-3000	Iridium(III) chloride hydrate (99.9%-Ir) (14996-61-3) IrCl ₃ ·XH ₂ O; FW: 298.58; black xtl.	1g 5g 25g
77-3010	Iridium(III) chloride, hydrate (99.99+%-Ir) PURATREM [free of Ir(IV) by electrochemical analysis] (14996-61-3) IrCl ₃ ·XH ₂ O; FW: 298.58; black xtl. <i>hygroscopic</i>	250mg 1g 5g
	NEW	
93-7727	Iridium(IV) chloride, hydrate (10025-97-5) IrCl ₄ ·XH ₂ O; FW: 334.03; black powdr.; m.p. dec.	250mg 1g 5g
93-7702	Iridium(IV) oxide, 99% (99.9+%-Ir) (12030-49-8) IrO ₂ ; FW: 224.20; blue to black powdr.; m.p. 1100° dec.; d. 11.66	1g 5g
77-5000	(Methylcyclopentadienyl) (1,5-cyclooctadiene)iridium(I), 99% (99.9%-Ir) (132644-88-3) (C ₅ H ₅)(C ₈ H ₁₂)Ir; FW: 379.53; white to off-white powdr.; m.p. 38-40°; b.p. subl. 100°/0.05mm For detailed technical note visit strem.com .	250mg 1g
		
77-6500	Potassium hexachloroiridate(IV), 99% (16920-56-2) See page 342	
77-6590	Potassium pentachloronitrosyl iridium(III), 99% (22594-86-1) See page 343	
77-0025	[2-(Pyridine-2-yl)-2-propanato]iridium(IV) dimer solution 97% (1 mM in 0.1 Molar aqueous NaO₃) (1446713-81-0) C ₁₆ H ₂₈ IrNO ₃ ; FW: 728.84; blue liq. Note: Sold under license from Catalytic Innovations, LLC for research purposes only. US Patent Publication No. US20150021194 A1. For detailed technical note visit strem.com .	10ml 50ml
	NEW	
		
77-8890	Sodium hexachloroiridate(IV) hexahydrate, 99% (19567-78-3) See page 418	
77-9000	Sodium hexachloroiridate(III) hydrate (123334-23-6) See page 418	
96-7710	SpinPHOX-Ir Catalyst Kit for enantioselective hydrogenation See page 489	

IRIDIUM (Compounds)

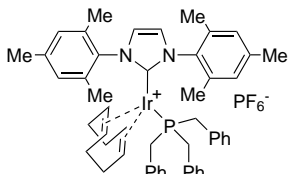
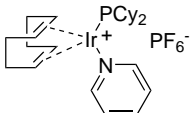
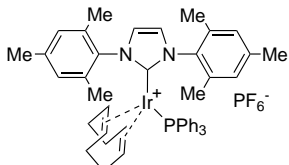
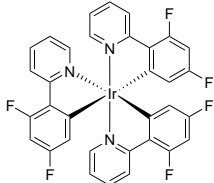
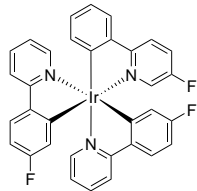
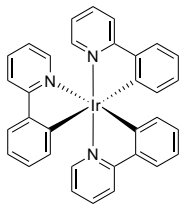
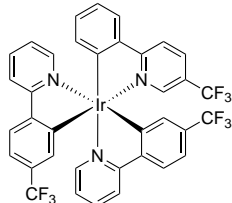
77-1810	Tribenzylphosphine(1,5-cyclooctadiene) [1,3-bis(2,4,6-trimethylphenyl)imidazol-2-ylidene]iridium(I) hexafluorophosphate, min. 98% (1019853-01-0) [Ir(C ₈ H ₁₂)(C ₂₁ H ₂₄ N ₂)(C ₂₁ H ₂₁ P)] ⁺ PF ₆ ⁻ ; FW: 1054.15; red xtl.		100mg 500mg
77-9500	(Tricyclohexylphosphine)(1,5-cyclooctadiene) (pyridine)iridium(I)hexafluorophosphate, 99% CRABTREE'S CATALYST (64536-78-3) [[C ₆ H ₁₁] ₃ P][C ₈ H ₁₂][C ₅ H ₅ N]Ir ⁺ PF ₆ ⁻ ; FW: 804.89; orange xtl. <i>moisture sensitive</i> For detailed technical note visit strem.com .		50mg 250mg 1g
77-1825	Triphenylphosphine(1,5-cyclooctadiene) [1,3-bis(2,4,6-trimethylphenyl)imidazol-2-ylidene]iridium(I) hexafluorophosphate, min. 98% (1019852-99-3) [Ir(C ₈ H ₁₂)(C ₂₁ H ₂₄ N ₂)(C ₁₈ H ₁₅ P)] ⁺ PF ₆ ⁻ ; FW: 1012.08; red xtl.		100mg 500mg
77-7030	Tris[2-(2,4-difluorophenyl)pyridine]iridium(III), 95% (387859-70-3) C ₃₃ H ₁₈ F ₆ IrN ₃ ; FW: 762.72; yellow powdr. <i>air sensitive</i> Note: Photocatalyst		50mg 250mg
77-6100	Tris[5-fluoro-2-(2-pyridinyl-kN)phenyl-kC]iridium(III), 95% (370878-69-6) C ₃₃ H ₂₁ F ₃ IrN ₃ ; FW: 708.75; yellow powdr. <i>air sensitive</i> Note: Photocatalyst		50mg 250mg
77-9700	Tris(norbornadiene)(acetylacetonato)iridium(III), 98% (99.9%-Ir) (41612-46-8) Ir(C ₇ H ₆ -C ₇ H ₈)(C ₇ H ₅)(C ₅ H ₇ O ₂); FW: 567.75; light yellow powdr.; m.p. 189°		100mg 500mg
77-7015	Tris(2-phenylpyridinato-C2,N)iridium(III), 95% (94928-86-8) C ₃₃ H ₂₄ IrN ₃ ; yellow powdr. <i>air sensitive</i> Note: Photocatalyst For detailed technical note visit strem.com .		50mg 250mg
77-6580	Tris[(2-(2-pyridinyl-kN)-5-(trifluoromethyl)phenyl-kC]iridium(III), 95% (500295-52-3) C ₃₆ H ₂₁ F ₉ IrN ₃ ; FW: 858.78; yellow solid <i>air sensitive</i> Note: Photocatalyst		50mg 250mg

IRON (Elemental Forms)

93-2664	Iron chips (99.95%) (7439-89-6) Fe; FW: 55.80; <2mm thick x <2mm x <25mm; m.p. 1535°; b.p. 3000°; d. 7.86	250g 1kg
93-2661	Iron foil (99.5+%) (7439-89-6) Fe; FW: 55.80; 0.127 mm thick x 25 mm wide; m.p. 1535°; b.p. 3000°; d. 7.86	25 x 25mm 100 x 25mm
26-0070	Iron lump (99.98%) (7439-89-6) Fe; FW: 55.80; 12 x 12 x 2mm and down (irregular); m.p. 1535°; b.p. 3000°; d. 7.86	250g 1kg 5kg
93-2663	Iron powder (99%) (7439-89-6) HAZ Fe; FW: 55.80; -100 mesh; m.p. 1535°; b.p. 3000°; d. 7.86	500g 2kg
93-2601	Iron powder (99.9%) (7439-89-6) HAZ Fe; FW: 55.80; 5-9 microns; m.p. 1535°; b.p. 3000°; d. 7.86	250g 1kg
93-2605	Iron powder (99.99%) (7439-89-6) HAZ Fe; FW: 55.80; -22 mesh; m.p. 1535°; b.p. 3000°; d. 7.86	10g 50g
93-2666	Stainless steel foil, type 304 (7439-89-6) Fe; FW: 55.80; 0.05 mm thick x 15 cm wide; m.p. 1535°; b.p. 3000°; d. 7.86	300 x 150mm 1500 x 150mm
93-2697	Stainless steel powder, type 304-L (7439-89-6) Fe; FW: 55.80; -100 mesh; m.p. 1535°; b.p. 3000°; d. 7.86	100g 500g
93-2671	Stainless steel powder, type 316 (52013-36-2) Fe; FW: 55.80; -325 mesh; m.p. 1535°; b.p. 3000°; d. 7.86	500g

IRON (Compounds)

26-0050	Acetylferrocene, 99.5% (1271-55-2) HAZ $\text{CH}_3\text{COC}_6\text{H}_4\text{FeC}_5\text{H}_5$; FW: 228.07; orange xtl.; m.p. 83°	5g 25g 100g
26-0320	1,1'-Bis[bis(5-methyl-2-furanyl) phosphino]ferrocene, 98% HiersoPHOS-3 (756824-22-3) $\text{C}_{30}\text{H}_{28}\text{FeO}_4\text{P}_2$; FW: 570.33; orange xtl. For detailed technical note visit strem.com .	100mg 500mg
26-0315	1',4-Bis(t-butyl)-1,2-bis(diphenylphosphino)-3'-(di-i-propylphosphino)ferrocene, 98% HiersoPHOS-1 (1313012-94-0) $\text{C}_{48}\text{H}_{57}\text{FeP}_3$; FW: 782.73; orange xtl. For detailed technical note visit strem.com .	100mg 500mg
26-0326	4,4'-Bis(t-butyl)-1,1',2,2'-tetrakis(diphenylphosphino)ferrocene, 98% HiersoPHOS-5 (403815-19-0) $\text{C}_{66}\text{H}_{62}\text{FeP}_4$; FW: 1034.94; orange xtl. For detailed technical note visit strem.com .	100mg 500mg
26-0318	1',4-Bis(t-butyl)-1,2,3'-tris(diphenylphosphino)ferrocene, 98% HiersoPHOS-2 (1159850-42-6) $\text{C}_{54}\text{H}_{53}\text{FeP}_3$; FW: 850.77; orange xtl. For detailed technical note visit strem.com .	100mg 500mg
26-1650	Bis(cyclooctatetraene)iron(0), min. 98% (12184-52-0) HAZ $(\text{C}_8\text{H}_8)_2\text{Fe}$; FW: 264.14; black xtl. <i>air sensitive, (store cold)</i>	100mg 500mg
26-1699	Bis(cyclopentadienyl)iron, 98% (Ferrocene) (102-54-5) $(\text{C}_5\text{H}_5)_2\text{Fe}$; FW: 186.04; orange xtl.; m.p. 172-173°	500g 2kg
26-1700	Bis(cyclopentadienyl)iron, 99% (Ferrocene) (102-54-5) $(\text{C}_5\text{H}_5)_2\text{Fe}$; FW: 186.04; orange xtl.; m.p. 172-173°	100g 500g 2kg

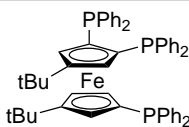
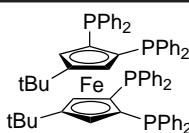
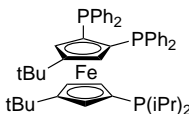
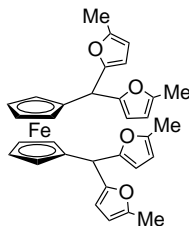

IRON (Compounds)

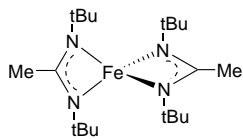
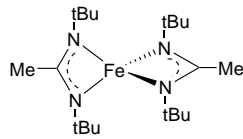
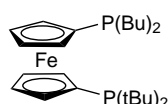
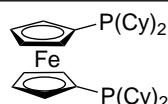
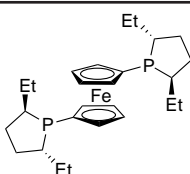
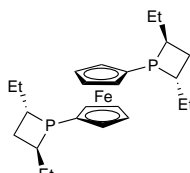
96-3730	1,1'-Bis(dialkyl/diarylphosphino)ferrocene Ligand Kit See page 501		
26-0145 amp	Bis(N,N'-di-t-butylacetamidinato)iron (II), min. 98% (635680-56-7) $C_{20}H_{42}N_4Fe$; FW: 394.42; off-white to gray xtl.; m.p. 107° <i>air sensitive, moisture sensitive</i> Note: Extremely air-sensitive. Contact Strem to discuss. Product sold under, use subject to, terms and conditions of label license at www.strem.com/harvard2 .		250mg 1g 5g
Technical Notes:			
1. Iron amidinate used in the chemical vapor deposition of iron, iron carbides and iron nitride films.			
2. Precursor for the MOCVD of iron-containing thin films.			
3. Fabrication of thin films of iron oxide via atomic layer deposition.			
References:			
1. <i>Journal of the Electrochemical Society</i> , 2010 , 157, D454			
2. <i>ECS Transactions</i> , 2009 , 25, 181			
3. <i>ACS Appl. Mater. Interfaces</i> 2015 , 7, 16138			
98-4038 NEW	Bis(N,N'-di-t-butylacetamidinato)iron(II), min. 98%, 26-0145, contained in 50 ml Swagelok® (96-1070) cylinder for CVD/ALD (635680-56-7) $C_{20}H_{42}N_4Fe$; FW: 394.42; off-white to gray xtl.; m.p. 107° <i>air sensitive, moisture sensitive</i> Note: Extremely air-sensitive. Contact Strem to discuss. Product sold under, use subject to, terms and conditions of label license at www.strem.com/harvard2		5g
26-0150	1,1'-Bis(di-t-butylphosphino)ferrocene, min. 98% DTBPF (84680-95-5) $[(C_4H_9)_2PC_5H_4]_2Fe$; FW: 474.42; orange to red xtl. Note: 1,1'-Bis(dialkyl/diarylphosphino)ferrocene Ligand Kit component. . For detailed technical note visit strem.com .		500mg 2g 10g
26-0160 HAZ	1,1'-Bis(dichlorophosphino)ferrocene, 98% (142691-70-1) $C_{10}H_6Cl_2FeP_2$; FW: 387.77; yellow pwdr. <i>moisture sensitive</i>		500mg 2g
26-0155	1,1'-Bis(dicyclohexylphosphino)ferrocene, min. 98% (146960-90-9) $[(C_6H_{11})_2P(C_6H_4)]_2Fe$; FW: 578.57; orange pwdr.; m.p. 138° Note: 1,1'-Bis(dialkyl/diarylphosphino)ferrocene Ligand Kit component.		500mg 2g 10g
26-1625	1,1'-Bis[(2R,5R)-2,5-diethylphospholano]ferrocene, min. 97% (147762-89-8) $C_{26}H_{40}FeP_2$; FW: 470.39; yellow solid <i>air sensitive</i> Note: Sold under license from Kanata for research purposes only.		250mg 1g
26-1626	1,1'-Bis[(2S,5S)-2,5-diethylphospholano]ferrocene, min. 97% (436863-50-2) $C_{26}H_{40}FeP_2$; FW: 470.39; yellow solid <i>air sensitive</i> Note: Sold under license from Kanata for research purposes only.		250mg 1g
26-0201	(-)-1,1'-Bis[(2S,4S)-2,4-diethylphosphonato]ferrocene, min. 95% (S,S)-Et-FerroTANE® (290347-66-9) $[C_5H_4(C_2H_4P)]_2Fe$; FW: 442.35; yellow-orange pwdr.; m.p. 76° <i>air sensitive</i> Note: **Limited quantities available** Sold in collaboration with Chirotech for research purposes only. US Patent no. 5936109. For detailed technical note visit strem.com .		100mg

IRON (Compounds)

26-0243	<p>1,1'-Bis((S)-4,5-dihydro-3H-binaphtho[1,2-c:2',1'-e]phosphino)ferrocene, min. 98% (S,S)-f-Binaphane (544461-38-3) $C_{54}H_{40}FeP_2$; FW: 806.69; yellow-brown powder. <i>air sensitive, light sensitive</i> Note: Sold in collaboration with Chiral Quest for research purposes only. US Patent No. 6,525,210, US6828271. For detailed technical note visit strem.com.</p>	100mg 500mg
26-0240	<p>(S,S)-(+)-2,2'-Bis((R)-(N,N-dimethylamino)(phenyl)methyl)-1,1'-bis(dicyclohexylphosphino)ferrocene, min. 97% (494227-35-9) $C_{52}H_{74}FeN_2P_2$; FW: 844.95; orange-red solid <i>(store cold)</i> Note: Sold in collaboration with Solvias for research purposes only. Solvias MandyPhos™ Ligand Kit component. For detailed technical note visit strem.com.</p>	100mg 500mg 2g 10g
26-0248	<p>(S,S)-(-)-2,2'-Bis((R)-(N,N-dimethylamino)(phenyl)methyl)-1,1'-bis(di(3,5-dimethyl-4-methoxyphenyl)phosphino)ferrocene, min. 97% (494227-37-1) $C_{64}H_{74}FeN_2O_4P_2$; FW: 1053.08; yellow to orange-red solid <i>(store cold)</i> Note: Sold in collaboration with Solvias for research purposes only. Solvias MandyPhos™ Ligand Kit component. For detailed technical note visit strem.com.</p>	100mg 500mg 2g 10g
26-0245	<p>(R,R)-(+)-2,2'-Bis((S)-(N,N-dimethylamino)(phenyl)methyl)-1,1'-bis(di(3,5-dimethylphenyl)phosphino)ferrocene, min. 97% (847997-73-3) $C_{60}H_{66}FeN_2P_2$; FW: 932.99; orange powder. <i>(store cold)</i> Note: Sold in collaboration with Solvias for research purposes only. For detailed technical note visit strem.com.</p>	100mg 500mg 2g 10g
26-0246	<p>(S,S)-(-)-2,2'-Bis((R)-(N,N-dimethylamino)(phenyl)methyl)-1,1'-bis(di(3,5-dimethylphenyl)phosphino)ferrocene, min. 97% (793718-16-8) $C_{60}H_{66}FeN_2P_2$; FW: 932.99; orange powder. <i>(store cold)</i> Note: Sold in collaboration with Solvias for research purposes only. Solvias MandyPhos™ Ligand Kit component.</p>	100mg 500mg 2g 10g
<p>Technical Note: 1. See 26-0245 (page 96)</p>		
26-0253	<p>(R,R)-(+)-2,2'-Bis((S)-(N,N-dimethylamino)(phenyl)methyl)-1,1'-bis(di(2-methylphenyl)phosphino)ferrocene, min. 97% (831226-39-2) $C_{56}H_{58}FeN_2P_2$; FW: 876.88; orange powder. <i>(store cold)</i> Note: Sold in collaboration with Solvias for research purposes only. For detailed technical note visit strem.com.</p>	100mg 500mg
26-0252	<p>(S,S)-(-)-2,2'-Bis((R)-(N,N-dimethylamino)(phenyl)methyl)-1,1'-bis(diphenylphosphino)ferrocene, min. 97% (174467-31-3) $C_{52}H_{50}FeN_2P_2$; FW: 820.76; orange-red solid <i>(store cold)</i> Note: Sold in collaboration with Solvias for research purposes only. Solvias MandyPhos™ Ligand Kit component. For detailed technical note visit strem.com.</p>	100mg 500mg 2g 10g

IRON (Compounds)

26-0244	<p>(S,S)-(-)-2,2'-Bis[(R)-(N,N-dimethylamino)(phenyl)methyl]-1,1'-bis(di(3,5-trifluoromethylphenyl)phosphino)ferrocene, min. 97% (494227-36-0) C₆₉H₄₂F₂₄FeN₂P₂; FW: 1364.74; orange-red solid (store cold) Note: Sold in collaboration with Solvias for research purposes only. Solvias MandyPhos™ Ligand Kit component. For detailed technical note visit strem.com.</p>		100mg 500mg 2g 10g
26-1150	<p>(R)-(-)-1-((S)-2-[Bis(3,5-dimethyl-4-methoxyphenyl)phosphino]ferrocenyl)ethylidicyclohexylphosphine, min. 97% (360048-63-1) C₄₂H₅₆FeO₂P₂; FW: 710.71; orange powder. Note: Sold in collaboration with Solvias for research purposes only. Solvias Josiphos Ligand Kit component. For detailed technical note visit strem.com.</p>		100mg 500mg 2g 10g
26-1130	<p>(R)-(+)-1-((R)-2-[2'-Bis(3,5-dimethyl-4-methoxyphenyl)phosphinophenyl]ferrocenyl)ethylbis(di-3,5-trifluoromethylphenyl) phosphine, min. 97% (494227-30-4) C₅₂H₄₄F₁₂FeO₂P₂; FW: 1046.68; orange powder. Note: Sold in collaboration with Solvias for research purposes only. Solvias Walphos Ligand Kit component. For detailed technical note visit strem.com.</p>		100mg 500mg
26-1618	<p>1,1'-Bis((2R,5R)-2,5-dimethylphospholano)ferrocene, min. 97% (540475-45-4) C₂₂H₃₂FeP₂; FW: 414.28; yellow solid <i>air sensitive</i> Note: Sold under license from Kanata for research purposes only. For detailed technical note visit strem.com.</p>		250mg 1g
26-1619	<p>1,1'-Bis((2S,5S)-2,5-dimethylphospholano)ferrocene, min. 97% (162412-87-5) C₂₂H₃₂FeP₂; FW: 414.28; yellow solid <i>air sensitive</i> Note: Sold under license from Kanata for research purposes only.</p>		250mg 1g
26-0270	<p>1,1'-Bis(diphenylphosphino)ferrocene, 99% DPPF (12150-46-8) (C₆H₅)₂PC₅H₄FeC₅H₄P(C₆H₅)₂; FW: 554.39; yellow to orange xtl.; m.p. 180° Note: Phosphine Ligand Kit component. 1,1'-Bis(dialkyl/diarylphosphino)ferrocene Ligand Kit component. For detailed technical note visit strem.com.</p>		1g 5g 25g 250g
26-0290	<p>1,1'-Bis(1-diphenylphosphino-1-methylethyl)ferrocene ethanol adduct, 97% HiersoPHOS-6 (Sylphos) (109313-83-9) C₄₀H₄₀FeP₂·CH₃CH₂OH; FW: 638.54 (684.61); orange solid For detailed technical note visit strem.com.</p>		100mg 500mg

IRON (Compounds)

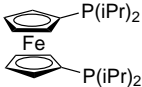
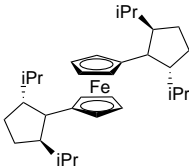
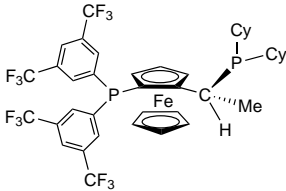
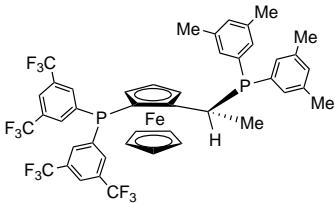
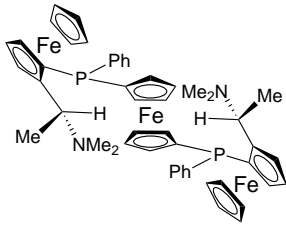
26-0275	1,1'-Bis(di-i-propylphosphino)ferrocene, min. 98% DiPPF (97239-80-0) [(C ₃ H ₇) ₂ PC ₂ H ₄] ₂ Fe; FW: 418.33; orange-yellow powdr. Note: 1,1'-Bis(dialkyl/diarylphosphino)ferrocene Ligand Kit component. . For detailed technical note visit strem.com .		500mg 2g 10g
45-0205	1,1'-Bis(di-i-propylphosphino)ferrocene(1,5-cyclooctadiene)rhodium(I) tetrafluoroborate, min. 98% (157772-65-1) See page 354		
26-1610	1,1'-Bis((2R,5R)-2,5-di-i-propylphospholano)ferrocene, min. 97% (849950-54-5) C ₃₀ H ₄₈ FeP ₂ ; FW: 526.49; yellow solid <i>air sensitive</i> Note: Sold under license from Kanata for research purposes only.		100mg 500mg
26-1611	1,1'-Bis((2S,5S)-2,5-di-i-propylphospholano)ferrocene, min. 97% (540475-73-8) C ₃₀ H ₄₈ FeP ₂ ; FW: 526.49; yellow solid <i>air sensitive</i> Note: Sold under license from Kanata for research purposes only.		100mg 500mg
26-0960	(R)-(-)-1-((S)-2-[Bis(3,5-di-trifluoromethylphenyl)phosphino]ferrocenyl)ethylidene-cyclohexylphosphine, min. 97% (292638-88-1) C ₄₀ H ₄₀ F ₁₂ FeP ₂ ; FW: 866.56; orange powdr. Note: Sold in collaboration with Solvias for research purposes only. Solvias Josiphos Ligand Kit component. For detailed technical note visit strem.com .		100mg 500mg 2g 10g
26-0965	(R)-(-)-1-((S)-2-[Bis(3,5-difluoromethylphenyl)phosphino]ferrocenyl)ethylidene-3,5-xylylphosphine, min. 97% (166172-63-0) C ₄₄ H ₃₆ F ₁₂ FeP ₂ ; FW: 910.57; orange powdr. Note: Sold in collaboration with Solvias for research purposes only. Solvias Josiphos Ligand Kit component. For detailed technical note visit strem.com .		100mg 500mg 2g 10g
26-0310	Bis(ethylcyclopentadienyl)iron, min. 98% (1273-97-8) [(C ₂ H ₅)C ₅ H ₄] ₂ Fe; FW: 242.14; orange liq.; d. 1.18		1g 5g
26-1261	1,1'-Bis(1-((R)-ferrocenyl-2-(S)-ethyl-1-(diethylamino) phenyl)-(R)-phosphino) ferrocene, min. 97% Trifer (899811-43-9) C ₅₀ H ₅₄ Fe ₃ N ₂ P ₂ ; FW: 912.46; orange powdr. Note: Sold in collaboration with Solvias for research purposes only. For detailed technical note visit strem.com .		100mg 500mg 2g 10g
26-1260	1,1'-Bis(1-((S)-ferrocenyl-2-(R)-ethyl-1-(dimethylamino) phenyl)-(S)-phosphino) ferrocene, min. 97% Trifer (900505-82-0) C ₅₀ H ₅₄ Fe ₃ N ₂ P ₂ ; FW: 912.46; orange powdr. Note: Sold in collaboration with Solvias for research purposes only.		100mg 500mg 2g 10g

Technical Note:

- See 26-1261 (page 98)

IRON (Compounds)

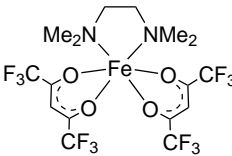
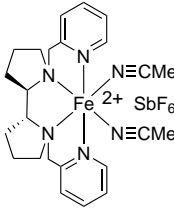
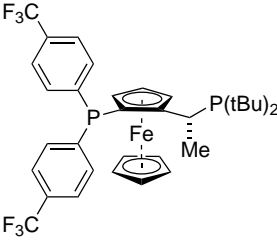
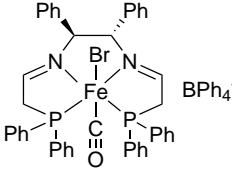
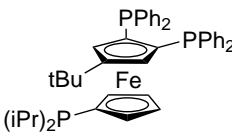
26-1640	Bis(1,1,1,5,5,5-hexafluoroacetylacetonato) (N,N,N',N'-tetramethylethylenediamine)iron(II), min. 98% (73450-43-8) C ₁₆ H ₁₈ F ₁₂ FeN ₂ O ₄ ; FW: 586.15; black xtl. <i>air sensitive</i> Note: Sold under license from Università degli Studi di Padova for research purposes only. Int. Patent App. PCT/IT2012/000276. Italian Patent App. PD2011A000285. For detailed technical note visit strem.com .		100mg 500mg
26-0400	Bis(pentamethylcyclopentadienyl)iron, 99% (12126-50-0) [(C ₅ H ₅ C ₅) ₂ Fe]; FW: 326.31; orange xtl.; m.p. 298-300° subl. <i>air sensitive</i>		1g 5g
26-0450	Bis(i-propylcyclopentadienyl)iron, min. 98% (12126-34-0) [(C ₃ H ₇)C ₅ H ₄] ₂ Fe; FW: 270.20; orange liq.		1g 5g
26-0061	(2R,2'R)-(-)-[N,N'-Bis(2-pyridylmethyl)-2,2'-bipyrrolidine]bis(acetonitrile)iron(II) hexafluoroantimonate Fe(R,R-PDP) White-Chen Catalyst (1361315-26-5) [C ₂₄ H ₃₂ FeN ₆ (SbF ₆) ₂]; FW: 931.90; purple pwdr. <i>air sensitive</i> Note: Patent pending.		100mg 500mg
26-0060	(2S,2'S)-(-)-[N,N'-Bis(2-pyridylmethyl)-2,2'-bipyrrolidine]bis(acetonitrile)iron(II) hexafluoroantimonate Fe(S,S-PDP) White-Chen Catalyst (959395-10-9) [C ₂₄ H ₃₂ FeN ₆] ²⁺ 2 (SbF ₆) ₂ ; FW: 931.90; purple pwdr. <i>air sensitive</i> Note: Patent pending. For detailed technical note visit strem.com .		100mg 500mg
26-0650	(R)-(-)-1-[(S)-2-[Bis(4-trifluoromethylphenyl)phosphino]ferrocenyl] ethyl-di-t-butylphosphine, min. 97% (246231-79-8) C ₃₄ H ₃₈ F ₆ FeP ₂ ; FW: 678.45; orange pwdr. Note: Sold in collaboration with Solvias for research purposes only. Solvias Josiphos Ligand Kit component. For detailed technical note visit strem.com .		100mg 500mg 2g 10g
26-0873	Bromocarbonyl[(1S,2S)-2,3-diphenylethylenediamine-N,N'-bis(2-diphenylphosphinoethylidene)]iron(II) tetraphenylborate, FeATHer-II Catalyst (1257252-03-1) C ₆₇ H ₆₅ BBrFeN ₂ OP ₂ ; FW: 1122.75; yellow pwdr. <i>air sensitive, moisture sensitive</i> Note: Sold in collaboration with GreenCentre for research purposes only. Patents: PCT/CA2013/050405, PCT 2013/010275. For detailed technical note visit strem.com .		100mg 500mg
26-0460	Bromoferrocene, 97% (1273-73-0) C ₁₀ H ₉ BrFe; FW: 264.93; orange solid		500mg 2g
26-0324	4-(t-Butyl)-1,2-bis(diphenylphosphino)-1'-(di-i-propylphosphino)ferrocene, 98% HiersoPHOS-4 (776315-37-8) C ₄₄ H ₄₉ FeP ₃ ; FW: 726.63; orange xtl. For detailed technical note visit strem.com .		100mg 500mg

IRON (Compounds)

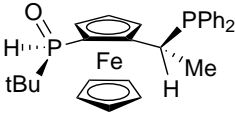
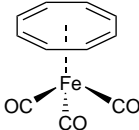
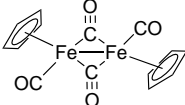
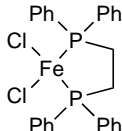
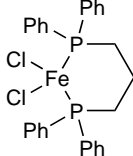
26-0700	t-Butylferrocene, min. 98% (1316-98-9) (C ₁₁ H ₁₄) ₂ FeC ₅ H ₅ ; FW: 242.15; dark-orange liq.; b.p. 80°/0.15mm; d. 1.201	1g 5g 25g
93-2602	n-Butylferrocene, 99% (31904-29-7) (C ₄ H ₉ C ₅ H ₄)Fe(C ₅ H ₅); FW: 242.14; orange to brown liq.; b.p. 232°C/630 mm; f.p. >230°F; d. 1.172 Note: For sale in USA. For other countries contact Strem.	10g 50g
26-1270	(R,S(p), R(SPO)-(1-t-Butylphosphinoyl)-2-[1-(diphenylphosphino)ethyl]ferrocene, min. 97% JoSPOphos (1221745-90-9) C ₂₈ H ₃₂ FeOP ₂ ; FW: 502.35; orange pwd. (store cold) Note: Sold in collaboration with Solvias for research purposes only. For detailed technical note visit strem.com .	100mg 500mg 2g 10g
		
26-1271	(S, R(p), S(SPO)-(1-t-Butylphosphinoyl)-2-[1-(diphenylphosphino)ethyl]ferrocene, min. 97% JoSPOphos (1221746-31-1) C ₂₈ H ₃₂ FeOP ₂ ; FW: 502.35; orange pwd. (store cold) Note: Sold in collaboration with Solvias for research purposes only. For detailed technical note visit strem.com .	100mg 500mg 2g 10g
26-0725	Butyroferrocene, 99% (1271-94-9) CH ₃ CH ₂ CH ₂ C(O)C ₅ H ₄ FeC ₅ H ₅ ; FW: 256.10; dark orange liq.; d. 1.254	5g 25g
58-0870	Mixed metal oxides of cerium(IV) [contains some Ce(III)] and iron(III) in octanoic acid and Kensol 50H (CEF-KE02) See page 149	
58-0865	Mixed metal oxides of cerium(IV) [contains some Ce(III)] and iron(III) in water at pH 4.75 ±0.25 (CEF-W420) See page 149	
26-0850 HAZ	Cyclohexadiene iron tricarbonyl, 98% (12152-72-6) C ₆ H ₈ Fe(CO) ₃ ; FW: 220.01; yellow to orange liq.; m.p. 8° air sensitive, (store cold)	5g
26-0875 HAZ	Cyclooctatetraene iron tricarbonyl, 98% (12093-05-9) C ₈ H ₈ Fe(CO) ₃ ; FW: 244.03; red to brown xtl.; m.p. 93-95° air sensitive	1g 5g
		
26-0900	Cyclopentadienyliron dicarbonyl dimer, 99% (12154-95-9) [C ₅ H ₅ Fe(CO) ₂] ₂ ; FW: 353.92; red to purple xtl.; m.p. 194° dec. air sensitive	10g 50g 250g
		
26-0952	1,1'-Dibromoferrocene, 97% (1293-65-8) C ₁₀ H ₈ Br ₂ Fe; FW: 343.82; yellow-orange solid	500mg 2g
26-0923 NEW	Dichloro[1,2-bis(diphenylphosphino)ethane]iron(II), 98% (41536-18-9) C ₂₆ H ₂₄ Cl ₂ FeP ₂ ; FW: 525.17; white-gray xtls. air sensitive For detailed technical note visit strem.com .	1g 5g
		
26-0945 NEW	Dichloro[1,3-bis(diphenylphosphino)propane]iron(II), 98% (106245-43-6) C ₂₇ H ₂₆ Cl ₂ FeP ₂ ; FW: 539.19; white pwd. air sensitive For detailed technical note visit strem.com .	1g 5g
		

IRON (Compounds)

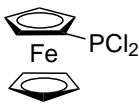
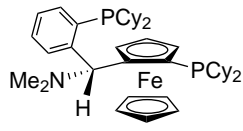
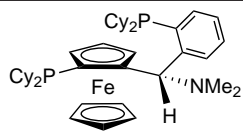
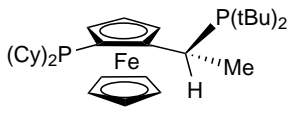
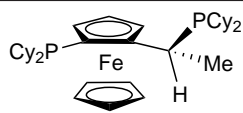
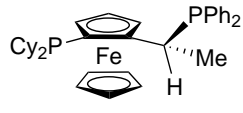
26-0985 HAZ	Dichlorophosphinoferrrocene, 98% (1291-31-2) C ₁₀ H ₉ Cl ₂ FeP; FW: 286.90; red-brown viscous liq. (solid when cold) <i>moisture sensitive</i> For detailed technical note visit strem.com .		1g 5g
26-0956	(R)-(+)-[(R)-2-Dicyclohexylphosphinoferrrocenyl] (N,N-dimethylamino)(2-dicyclohexylphosphinophenyl)methane, min. 97% (1156547-61-3) C ₄₃ H ₆₃ FeNP ₂ ; FW: 711.76; orange powdr. (store cold) Note: Sold in collaboration with Solvias for research purposes only. For detailed technical note visit strem.com .		100mg 500mg 2g 10g
26-0955	(S)-(-)-[(S)-2-Dicyclohexylphosphinoferrrocenyl] (N,N-dimethylamino)(2-dicyclohexylphosphinophenyl)methane, min. 97% (914089-00-2) C ₄₃ H ₆₃ FeNP ₂ ; FW: 711.76; orange powdr. (store cold) Note: Sold in collaboration with Solvias for research purposes only. For detailed technical note visit strem.com .		100mg 500mg 2g 10g
26-0975	(R)-(-)-1-[(S)-2-(Dicyclohexylphosphino)ferrocenyl]ethylidene-t-butylphosphine, min. 97% (158923-11-6) C ₃₂ H ₅₂ FeP ₂ ; FW: 554.56; orange powdr. Note: Sold in collaboration with Solvias for research purposes only. Solvias Josiphos Ligand Kit component. For detailed technical note visit strem.com .		100mg 500mg 2g 10g
26-1000	(R)-(-)-1-[(S)-2-(Dicyclohexylphosphino)ferrocenyl]ethylidene-dicyclohexylphosphine, min. 97% (167416-28-6) C ₃₆ H ₅₆ FeP ₂ ; FW: 606.64; orange powdr. Note: Sold in collaboration with Solvias for research purposes only. Solvias Josiphos Ligand Kit component. For detailed technical note visit strem.com .		100mg 500mg 2g 10g
26-1001	(S)-(+)-1-[(R)-2-(Dicyclohexylphosphino)ferrocenyl]ethylidene-dicyclohexylphosphine, min. 97% (246231-77-6) C ₃₆ H ₅₆ FeP ₂ ; FW: 606.64; orange powdr. Note: Sold in collaboration with Solvias for research purposes only. For detailed technical note visit strem.com .		100mg 500mg 2g 10g
26-1230	(R)-(-)-1-[(S)-2-(Dicyclohexylphosphino)ferrocenyl]ethylidene-diphenylphosphine, min. 97% (158923-09-2) C ₃₆ H ₄₄ FeP ₂ ; FW: 594.59; orange powdr. Note: Sold in collaboration with Solvias for research purposes only. For detailed technical note visit strem.com .		100mg 500mg 2g 10g
26-1101	(S)-(+)-1-[(R)-2-(Dicyclohexylphosphino)ferrocenyl]ethylidene-diphenylphosphine, min. 97% (162291-01-2) C ₃₆ H ₄₄ FeP ₂ ; FW: 594.59; orange powdr. Note: Sold in collaboration with Solvias for research purposes only.		100mg 500mg 2g 10g



Technical Note:

- See 26-1230 (page 101)

IRON (Compounds)

26-1120	(R)-(+)-1-[(R)-2-(2'-Dicyclohexylphosphino-phenyl)ferrocenyl]ethylbis(3,5-trifluoromethylphenyl)phosphine, min. 97% (821009-34-1) C ₄₆ H ₄₄ F ₁₂ FeP ₂ ; FW: 942.62; orange powd. (store cold) Note: Sold in collaboration with Solvias for research purposes only. Solvias Walphos Ligand Kit component. For detailed technical note visit strem.com .		100mg 500mg 2g 10g
26-1170	(S)-(+)-1-[(R)-2-(Di-2-furylphosphino)ferrocenyl]ethyl-di-3,5-xylylphosphine, min. 97% (649559-66-0) C ₃₆ H ₃₆ FeO ₂ P ₂ ; FW: 618.46; orange powd. Note: Sold in collaboration with Solvias for research purposes only. Solvias Josiphos Ligand Kit component. For detailed technical note visit strem.com .		100mg 500mg 2g 10g
26-1490	(S)-(-)-[4,5-Dihydro-4-(1-methylethyl)-2-oxazolyl]ferrocene, min. 98% (162157-03-1) C ₁₆ H ₁₉ FeNO; FW: 297.17; orange powd.		1g 5g
26-1399	α-(N,N-Dimethylamino)ethylferrocene, 98% (31904-34-4) (C ₅ H ₅)Fe(C ₅ H ₄ CH(CH ₃)N(CH ₃) ₂); FW: 257.16; orange liq.; b.p. 110°C/0.45mm; d. 1.222		1g 5g 25g
26-1400	N,N-Dimethylaminomethylferrocene, min. 95% (1271-86-9) (CH ₃) ₂ NCH ₂ C ₅ H ₄ FeC ₅ H ₅ ; FW: 243.13; amber liq.; b.p. 91-92°C/0.5mm; f.p. >230°F; d. 1.228		5g 25g 100g
26-1410	(R)-(+)-4-Dimethylaminopyrindinyl(pentaphenylcyclopentadienyl)iron, min. 98% (R)-C ₅ Ph ₅ -DMAP (187682-64-0) C ₄₅ H ₃₆ FeN; FW: 660.60; purple xtl.; m.p. 231-234° Note: Limited quantities available. For detailed technical note visit strem.com .		100mg
26-1500	1,1'-Dimethylferrocene, min. 98% (1291-47-0) (CH ₃ C ₅ H ₄) ₂ Fe; FW: 214.09; orange xtl.; m.p. 32-37° air sensitive		2g 10g
26-1175	(R)-(-)-1-[(S)-2-(Di-1-naphthylphosphino)ferrocenyl]ethyl-di-3,5-xylylphosphine, min. 97% (851308-40-2) C ₄₈ H ₄₄ FeP ₂ ; FW: 738.68; orange powd. Note: Sold in collaboration with Solvias for research purposes only. For detailed technical note visit strem.com .		100mg 500mg 2g 10g
26-1240	NEW 1-Diphenylphosphino-1'-(di-t-butylphosphino)ferrocene, 97% (95408-38-1) C ₃₀ H ₃₆ FeP ₂ ; FW: 514.40; yellow to orange powd.; m.p. 75-79° air sensitive		250mg 1g

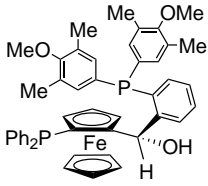
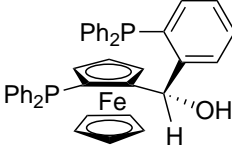
IRON (Compounds)

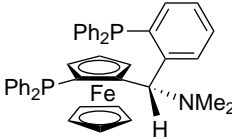
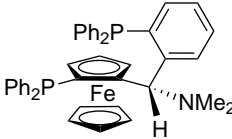
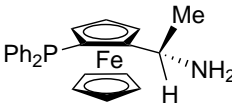
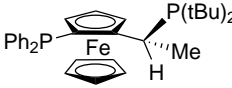
26-1153	(S)-(-)-[(S)-2-Diphenylphosphinoferrrocenyl] [2-bis(3,5-dimethyl-4-methoxyphenyl)phosphino- phenyl]methanol, min. 97% (851308-47-9) C ₄₇ H ₄₇ FeO ₂ P ₂ ; FW: 777.68; orange foam Note: Air-stable. Sold in collaboration with Solvias for research purposes only.		100mg
26-1160	(S)-(-)-[(S)-2-Diphenylphosphinoferrrocenyl] [2-diphenylphosphinophenyl]methanol, min. 97% (851308-43-5) C ₄₁ H ₃₄ FeOP ₂ ; FW: 660.50; yellow powdr. Note: Air-stable. Sold in collaboration with Solvias for research purposes only.		100mg 500mg
26-1151	(R)-(-)-1-[(S)-2-(Diphenylphosphino)ferrrocenyl] benzylamine, min. 98% (498580-48-6) C ₂₉ H ₂₆ FeNP; FW: 475.34; yellow to orange powdr.		100mg 500mg
Technical Note:			
1. Precursor ligand for the preparation of catalysts used in palladium-catalyzed asymmetric allylic alkylations.			
26-1152	(S)-(+)-1-[(R)-2-(Diphenylphosphino)ferrrocenyl]benzylamine, min. 98% C ₂₉ H ₂₆ FeNP; FW: 475.34; yellow to orange powdr. For detailed technical note visit strem.com .		100mg 500mg
26-1156	(R)-(+)-[(R)-2-Diphenylphosphinoferrrocenyl](N,N-dimethylamino)(2-diphenyl- phosphinophenyl)methane, min. 97% (1003012-96-1) C ₄₃ H ₃₉ FeNP ₂ ; FW: 687.57; orange powdr. (store cold) Note: Sold in collaboration with Solvias for research purposes only. For detailed technical note visit strem.com .		100mg 500mg 2g 10g
26-1155	(S)-(-)-[(S)-2-Diphenylphosphinoferrrocenyl] (N,N-dimethylamino)(2-diphenylphosphino- phenyl)methane, min. 97% TANIAPHOS (850444-36-9) C ₄₃ H ₃₉ FeNP ₂ ; FW: 687.57; orange powdr. (store cold) Note: Sold in collaboration with Solvias for research purposes only. For detailed technical note visit strem.com .		100mg 500mg 2g 10g
26-1425	(R)-1-[(S)-2-Diphenylphosphino)ferrrocenylethyl- amine, min. 97% (607389-84-4) C ₂₄ H ₂₄ FeNP; FW: 413.27; yellow solid <i>air sensitive</i>		100mg 500mg
26-1426	(S)-1-[(R)-2-Diphenylphosphino)ferrrocenylethylamine, min. 97% C ₂₄ H ₂₄ FeNP; FW: 413.27; yellow solid <i>air sensitive</i>		100mg 500mg
26-1200	(R)-(-)-1-[(S)-2-(Diphenylphosphino)ferrrocenyl] ethyl-di-t-butylphosphine, min. 97% (155830-69-6) C ₃₆ H ₄₀ FeP ₂ ; FW: 542.46; orange powdr. Note: Sold in collaboration with Solvias for research purposes only. Solvias Josiphos Ligand Kit com- ponent. For detailed technical note visit strem.com .		100mg 500mg 2g 10g
26-1201	(S)-(+)-1-[(R)-2-(Diphenylphosphino)ferrrocenyl]ethyl-di-t-butylphosphine, min. 97% (277306-29-3) C ₃₆ H ₄₀ FeP ₂ ; FW: 542.46; orange powdr. Note: Sold in collaboration with Solvias for research purposes only. For detailed technical note visit strem.com .		100mg 500mg 2g 10g

IRON (Compounds)

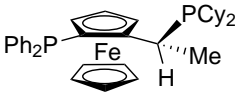
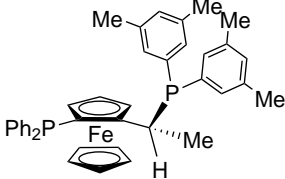
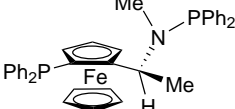
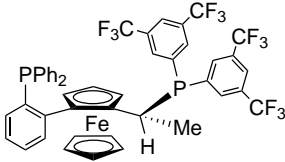
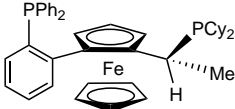
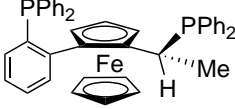
26-1210	(R)-(-)-1-[(R)-2-(Diphenylphosphino)ferrocenyl]ethylcyclohexylphosphine ethanol adduct, min. 97% (R)-(S)-JOSIPHOS (155806-35-2) C ₃₆ H ₄₄ FeP ₂ ·CH ₃ CH ₂ OH; FW: 594.59 (640.66); orange powdr. (store cold) Note: Sold in collaboration with Solvias for research purposes only. Solvias Josiphos Ligand Kit component. For detailed technical note visit strem.com .		100mg 500mg 2g 10g
26-1211	(S)-(+)-1-[(R)-2-(Diphenylphosphino)ferrocenyl]ethylcyclohexylphosphine ethanol adduct, min. 97% (S)-(R)-JOSIPHOS (162291-02-3) C ₃₆ H ₄₄ FeP ₂ ·CH ₃ CH ₂ OH; FW: 594.59 (640.66); orange powdr. (store cold) Note: Sold in collaboration with Solvias for research purposes only. For detailed technical note visit strem.com .		100mg 500mg 2g 10g
26-1255	(R)-(-)-1-[(S)-2-(Diphenylphosphino)ferrocenyl]ethyl-di-3,5-xyllylphosphine, min. 97% (184095-69-0) C ₄₀ H ₄₀ FeP ₂ ; FW: 638.56; orange powdr. Note: Sold in collaboration with Solvias for research purposes only. Solvias Josiphos Ligand Kit component. For detailed technical note visit strem.com .		100mg 500mg 2g 10g
26-2515	(R)-1-[(S)-2-Diphenylphosphinoferrocenyl]-(N-methyl)(N-diphenylphosphino)ethylamine (R)-Me-Bophoz (406680-94-2) C ₃₇ H ₃₅ FeNP ₂ ; FW: 611.50; yellow solid Note: Sold in collaboration with JM for research purposes only. For detailed technical note visit strem.com .		100mg 500mg
26-2516	(S)-1-[(R)-2-Diphenylphosphinoferrocenyl]-(N-methyl)(N-diphenylphosphino)ethylamine (S)-Me-Bophoz (406681-09-2) C ₃₇ H ₃₅ FeNP ₂ ; FW: 611.50; yellow solid Note: Sold in collaboration with JM for research purposes only. For detailed technical note visit strem.com .		100mg 500mg
26-1300	(R)-(-)-1-[(R)-2-(2'-Diphenylphosphinophenyl)ferrocenyl]ethylbis(di-3,5-trifluoromethylphenyl)phosphine, min. 97% (565184-33-0) C ₄₆ H ₃₂ F ₁₂ FeP ₂ ; FW: 930.52; orange powdr. Note: Sold in collaboration with Solvias for research purposes only. Solvias Walphos Ligand Kit component. For detailed technical note visit strem.com .		100mg 500mg 2g 10g
26-1310	(R)-(-)-1-[(R)-2-(2'-Diphenylphosphinophenyl)ferrocenyl]ethylcyclohexylphosphine, min. 97% (565184-29-4) C ₄₂ H ₄₈ FeP ₂ ; FW: 670.62; orange powdr. Note: Sold in collaboration with Solvias for research purposes only. Solvias Walphos Ligand Kit component. For detailed technical note visit strem.com .		100mg 500mg 2g 10g
26-1315	(R)-(+)-1-[(R)-2-(2'-Diphenylphosphinophenyl)ferrocenyl]ethylbisdiphenylphosphine, min. 97% (565184-32-9) C ₄₂ H ₃₈ FeP ₂ ; FW: 658.53; orange powdr. Note: Sold in collaboration with Solvias for research purposes only. Solvias Walphos Ligand Kit component. For detailed technical note visit strem.com .		100mg 500mg 2g 10g

IRON (Compounds)

26-1320	<p>(R)-(+)-1-[(R)-2-(2'-Diphenylphosphino-phenyl)ferrocenyl]ethyldi(3,5-xylyl)phosphine, min. 97% (894771-25-6) $C_{46}H_{44}FeP_2$; FW: 714.63; orange powdr. <i>(store cold)</i> Note: Sold in collaboration with Solvias for research purposes only. Solvias Walphos Ligand Kit component. For detailed technical note visit strem.com.</p>		100mg 500mg 2g 10g
26-1560	<p>(S)-(-)-[(S)-2-Di(3,5-xylyl)phosphinoferrocenyl][2-di(4-trifluoromethylphenyl)phosphino-phenyl]methanol, min. 97% (851308-48-0) $C_{47}H_{40}F_6FeOP_2$; FW: 852.60; yellow powdr. Note: Air-stable. Sold in collaboration with Solvias for research purposes only. **Limited quantities available**</p>		100mg
26-1565	<p>(S)-(-)-[(S)-2-Di(3,5-xylyl)phosphinoferrocenyl][2-di(3,5-xylyl)phosphino-phenyl]methanol, min. 97% (851308-45-7) $C_{46}H_{50}FeOP_2$; FW: 772.71; orange foam Note: Air-stable. Sold in collaboration with Solvias for research purposes only.</p>		100mg 500mg
26-1555	<p>(R)-(+)-1-[(R)-2-(2'-Di-3,5-xytyl-phosphino-phenyl)ferrocenyl]ethyldi-3,5-xylylphosphine, min. 97% (894771-28-9) $C_{50}H_{52}FeP_2$; FW: 770.74; orange-red solid Note: Sold in collaboration with Solvias for research purposes only. Solvias Walphos Ligand Kit component. For detailed technical note visit strem.com.</p>		100mg 500mg 2g 10g
26-1600	<p>Ethylferrocene, 98% (1273-89-8) $C_{22}H_{20}Fe$; FW: 214.09; red-orange liq.; d. 1.256</p>	5g 25g	
26-1750	<p>Ferrocene carboxaldehyde, min. 98% (12093-10-6) $H(O)CC_5H_4FeC_5H_5$; FW: 214.05; orange to red xtl.; m.p. 124° <i>light sensitive</i></p>	2g 10g 50g	
26-1800	<p>1,1'-Ferrocene dicarboxylic acid, min. 96% (1293-87-4) $(HO(O)CC_5H_4)_2Fe$; FW: 274.06; orange xtl.; m.p. 235° dec. Note: For sale in USA. For other countries contact Strem.</p>	1g 5g	
26-1900	<p>Ferrocene monocarboxylic acid, min. 97% (1271-42-7) $(HO(O)CC_5H_4)FeC_5H_5$; FW: 230.05; yellow xtl.; m.p. 210° dec. Note: For sale in USA. For other countries contact Strem.</p>	1g 5g 25g	
26-1430	<p>Ferrocenylacetic acid, min. 98% (1287-16-7) $(C_5H_5)Fe(C_5H_4)CH_2C(O)OH$; FW: 244.07; orange-brown powdr.; m.p. 158-160° Note: For sale in USA. For other countries contact Strem.</p>	500mg 2g	

IRON (Compounds)

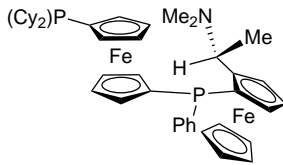
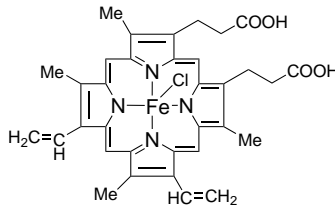
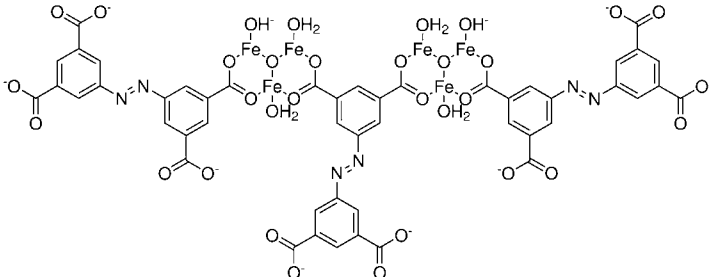
26-1266	1-(((S)-Ferrocenyl-2-(S)-ethyl-1-dimethylamino)phenyl)-(R)-phosphino)-1'-dicyclohexylphosphinoferrocene, min. 97% Chenphos (952586-19-5) C ₄₂ H ₅₃ Fe ₂ NP ₂ ; FW: 745.51; orange powdr. Note: Sold in collaboration with Solvias for research purposes only. For detailed technical note visit strem.com .		100mg 500mg 2g 10g
26-1265	1-(((S)-Ferrocenyl-2-(R)-ethyl-1-dimethylamino)phenyl)-(S)-phosphino)-1'-dicyclohexylphosphinoferrocene, min. 97% Chenphos (1036373-39-3) C ₄₂ H ₅₃ Fe ₂ NP ₂ ; FW: 745.51; orange powdr. Note: Sold in collaboration with Solvias for research purposes only.		100mg 500mg 2g 10g
Technical Note: 1. See 26-1266 (page 106)			
26-1450	Ferrocenyltrimethylammonium iodide, 99% (12086-40-7) [C ₅ H ₅ FeC ₅ H ₄ CH ₂ N(CH ₃) ₃] ⁺ I ⁻ ; FW: 385.08; yellow xtl.; m.p. 220° dec.		5g 25g
26-1480	Hemin (Ferritroporphyrin IX chloride), min. 95% (16009-13-5) Fe(C ₃₄ H ₃₂ N ₄ O ₄)Cl; FW: 651.95; black xtl.		5g 25g
26-2000	α-Hydroxyethylferrocene, 98% (1277-49-2) (CH ₃ CHOHC ₅ H ₄)FeC ₅ H ₅ ; FW: 230.09; yellow xtl.; m.p. 76-77°		1g 5g
26-2200	Hydroxymethylferrocene, 99% (1273-86-5) HOCH ₂ C ₅ H ₄ FeC ₅ H ₅ ; FW: 216.07; yellow xtl.; m.p. 66-70°		1g 5g
93-2678	Iron(II) acetate, anhydrous, 97% (3094-87-9) Fe(OOCCH ₃) ₂ ; FW: 173.94; off-white to light brown powdr. <i>air sensitive, moisture sensitive</i>		5g 25g 100g
26-2300	Iron(III) acetylacetonate, 99% (14024-18-1) Fe(CH ₃ C(O)CHC(O)CH ₃) ₃ ; FW: 353.18; orange to red xtl.; m.p. 184°; b.p. 110°C/2mm; d. 5.24		50g 250g
26-3725	Iron azobenzene tetracarboxylic, Porous [PCN-250(Fe)], CONEKTIC™ F250 (1771755-22-6) Dark red-brown powdr. Note: Sold in collaboration with framergy for research purposes only. PCT/ GB2014/053506 For detailed technical note visit strem.com .		500mg 2g 10g

NEW

IRON (Compounds)

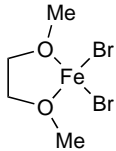
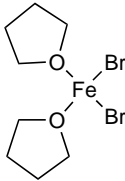
26-2340 NEW	Iron(III) 1,3,5-benzenetricarboxylate hydrate, porous (F-free MIL-100(Fe), KRICT F100) [Iron trimesate] (1257379-83-1) [Fe ₃ O(H ₂ O) ₂ (OH){C ₆ H ₃ (COO) ₃] ₂ ·XH ₂ O; red solid Note: Sold under agreement with KRICT for research and development purposes only. Patents US 8507399 B2, US 8252950 B2.	KRICT F100 	500mg 2g
93-2629	Iron(II) bromide, anhydrous, 98% (7789-46-0) FeBr ₂ ; FW: 215.67; orange powdr.; m.p. 684° dec.; d. 4.636 <i>hygroscopic</i>		10g 50g
26-0065 NEW	Iron(II) bromide, dimethoxyethane, min. 98% (99611-53-7) FeBr ₂ ·CH ₃ O(CH ₂) ₂ OCH ₃ ; FW: 305.77; brown xtl. <i>moisture sensitive</i>		1g 5g 25g
93-2628	Iron(II) bromide hydrate (13463-12-2) FeBr ₂ ·XH ₂ O; FW: 215.67; greenish-black xtl.; m.p. 27°		25g 100g
26-0078 NEW	Iron(II) bromide, Bis(tetrahydrofuran), min. 98% (70317-91-8) FeBr ₂ (C ₄ H ₈ O) ₂ ; FW: 359.86; brown xtl. <i>air sensitive, moisture sensitive</i>		1g 5g 25g
93-2665	Iron(III) bromide, anhydrous, 99% (10031-26-2) FeBr ₃ ; FW: 295.57; reddish-black xtl.; m.p. subl. dec. <i>hygroscopic</i>		10g 50g
26-2630	Iron(II) carbonate, tech. gr. (Siderite) (14476-16-5) FeCO ₃ ; FW: 115.85; white to gray powdr.		5g 25g
93-2631 HAZ	Iron(II) chloride, anhydrous, 98% (7758-94-3) FeCl ₂ ; FW: 126.75; tan powdr.; m.p. 674°; b.p. 1023°; d. 3.162 <i>air sensitive, hygroscopic</i>		25g 100g
93-2632 HAZ	Iron(II) chloride tetrahydrate, 99% (13478-10-9) FeCl ₂ ·4H ₂ O; FW: 126.75 (198.81); light green xtl.; m.p. 110° (dec.); d. 1.93		250g 1kg
93-2607 HAZ	Iron(III) chloride, anhydrous, 98% (7705-08-0) FeCl ₃ ; FW: 162.22; black powdr.; m.p. 304°; d. 2.804 <i>hygroscopic</i>		1kg 5kg
93-2606 HAZ	Iron(III) chloride hexahydrate, 97+% (ACS) (10025-77-1) FeCl ₃ ·6H ₂ O; FW: 162.22 (270.32); yellow lump; m.p. 37°		250g 1kg
26-2400	Iron disulfide (Iron pyrite), 95% (12068-85-8) FeS ₂ ; FW: 119.97; -20 mesh powdr.		1kg 5kg
26-2500 HAZ	Iron dodecacarbonyl (Stabilized with 5-10% methanol) (17685-52-8) Fe ₃ (CO) ₁₂ ; FW: 503.67; black xtl.; m.p. 140° dec.; d. 2.00 <i>air sensitive, (store cold)</i>		10g 50g
26-2520 HAZ	Iron 2-ethylhexanoate, 6% (Fe) in mineral spirits (99.998+% Fe) PURATREM (7321-53-1) Fe[OOCCH(C ₂ H ₅)C ₄ H ₉] ₂ ; FW: 485.46; liq.		50g 250g
93-2675	Iron(II) fluoride, anhydrous, 99% (7789-28-8) FeF ₂ ; FW: 93.84; -80 mesh off-white powdr.; m.p. > 1000°; d. 4.09 <i>hygroscopic</i>		5g 25g
93-2610 HAZ	Iron(III) fluoride, anhydrous, 99+% (7783-50-8) FeF ₃ ; FW: 112.84; greenish-brown powdr.; m.p. subl. > 1000°; d. 3.52 <i>hygroscopic</i>		10g 50g

IRON (Compounds)

93-2670	Iron(III) fluoride trihydrate, 98% (15469-38-2)	25g
HAZ	FeF ₃ ·3H ₂ O; FW: 112.84 (166.89); light yellow powdr.	100g
93-2613	Iron naphthenate, 40% in mineral spirits (6% Fe) (1338-14-3)	500g
HAZ	brown liq.; f.p. 104°F; d. 0.90	2kg
26-2600	Iron naphthenate, 80% in mineral spirits (12% Fe) (1338-14-3)	500g
HAZ	brown liq.; f.p. >100°F	2kg
93-2614	Iron(III) nitrate nonahydrate, 98+% (7782-61-8)	250g
HAZ	Fe(NO ₃) ₃ ·9H ₂ O; FW: 241.86 (404.02); light purple xtl.; m.p. 47.2°; b.p. 125° dec.; d. 1.684	1kg
	<i>hygroscopic</i>	5kg
93-2672	Iron(III) nitrate nonahydrate (99.999%-Fe) PURATREM (7782-61-8)	5g
HAZ	Fe(NO ₃) ₃ ·9H ₂ O; FW: 241.86 (404.02); colorless to pale violet xtl.; m.p. 47.2°; b.p. 125° dec.; d. 1.684	25g
	<i>hygroscopic</i>	
26-2640	Iron nonacarbonyl, 99% (15321-51-4)	5g
HAZ	Fe ₂ (CO) ₉ ; FW: 363.79; yellow to orange xtl.; m.p. 100° dec.; d. 2.85	25g
	<i>air sensitive, (store cold)</i>	100g
93-2636	Iron(II) oxalate dihydrate, min. 95% (6047-25-2)	500g
	FeC ₂ O ₄ ·2H ₂ O; FW: 143.87 (179.90); yellow powdr.; m.p. 190° dec.; d. 2.28	2kg
93-2615	Iron(III) oxalate hexahydrate, tech. gr. (19469-07-9)	5g
HAZ	Fe ₂ (C ₂ O ₄) ₃ ·6H ₂ O; FW: 375.76 (483.86); yellow powdr.	25g
93-2616	Iron(II,III) oxide, black (Magnetite), min. 95% (1317-61-9)	500g
	Fe ₃ O ₄ ; FW: 231.54; black powdr.; m.p. 1538° dec.; d. 5.18	2kg
26-0032	Iron(II,III) oxide (Magnetite) aqueous magnetic fluid [3.5 vol%, Ms = 15-16 kA/m] (1317-61-9)	
	<i>See page 158</i>	
26-0036	Iron(II,III) oxide (Magnetite) aqueous magnetic fluid [7.0 vol%, Ms = 30-31 kA/m] (1317-61-9)	
	<i>See page 158</i>	
26-0022	Iron(II,III) oxide (Magnetite) magnetic fluid in kerosene with oleic acid [7-9 vol%, Ms = 35-45 kA/m] (1317-61-9)	
	<i>See page 158</i>	
26-0024	Iron(II,III) oxide (Magnetite) magnetic fluid in kerosene with oleic acid [15-18 vol%, Ms = 50-70 kA/m] (1317-61-9)	
	<i>See page 158</i>	
26-2750	Iron(III) oxide (99.995%-Fe) PURATREM (1309-37-1)	10g
	Fe ₂ O ₃ ; FW: 159.69; red to brown powdr.; m.p. 1565°	50g
93-2618	Iron(III) oxide monohydrate, yellow (99.9+%-Fe) (51274-00-1)	1kg
	Fe ₂ O ₃ ·H ₂ O; FW: 159.69 (177.71); yellow powdr.	5kg
93-2617	Iron(III) oxide, red (Hematite) (99.8%-Fe) (1317-60-8)	250g
	Fe ₂ O ₃ ; FW: 159.69; red powdr.	1kg
		5kg
	Iron oxide nanoparticles, organic solvent-dispersible (in chloroform) (1309-37-1)	
	<i>See page 160</i>	
	Iron oxide nanoparticles in water, with amine surface functional group (1309-37-1)	
	<i>See page 159</i>	
	Iron oxide nanoparticles in water, with carboxylic acid surface functional group (1309-37-1)	
	<i>See page 159</i>	
	Iron oxide nanoparticles in water, with PEG (1309-37-1)	
	<i>See page 160</i>	
26-2758	Iron(III) oxyhydroxide in water at pH = 3.0 +/- 0.5 (FEO-W320) (20344-49-4)	
	<i>See page 159</i>	
26-2800	Iron pentacarbonyl, 99.5% (99.9+%-Fe) (13463-40-6)	250g
HAZ	Fe(CO) ₅ ; FW: 195.90; orange liq.; m.p. -20°; b.p. 103°; f.p. 5°F; d. 1.490	1kg
	<i>air sensitive, (store cold)</i>	

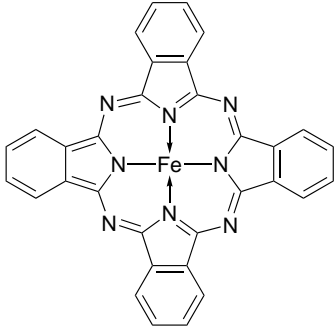

IRON (Compounds)

26-2801 HAZ 	Iron pentacarbonyl, 99.5% (99.9+%-Fe) (Sure/Seal™ bottle) (13463-40-6) Fe(CO) ₅ ; FW: 195.90; orange liq.; m.p. -20°; b.p. 103°; f.p. 5°F; d. 1.490 <i>air sensitive, (store cold)</i>	250g 1kg
93-2673 HAZ	Iron(III) perchlorate hydrate (purple) (15201-61-3) Fe(ClO ₄) ₃ ·XH ₂ O; FW: 354.22; purple xtl. <i>hygroscopic</i>	50g 250g
93-2620 HAZ	Iron(III) perchlorate hydrate (yellow) (15201-61-3) Fe(ClO ₄) ₃ ·XH ₂ O; FW: 354.22; yellow xtl. <i>hygroscopic</i>	50g 250g
93-2647	Iron(III) phosphate hydrate (13463-10-0) FePO ₄ ·XH ₂ O; FW: 150.82; off-white powdr.	500g 2kg
26-2825	Iron(II) phthalocyanine, min. 95% (132-16-1) (C ₃₂ H ₁₆ N ₈)Fe; FW: 568.38; dark purple xtl.	1g 5g
		
26-2860	Iron(III) i-propoxide (99.9+%-Fe) (14995-22-3) Fe(OC ₃ H ₇) ₃ ; FW: 233.12; brown to black solid <i>moisture sensitive</i>	25g
93-2648	Iron silicide, 99% (12022-99-0) FeSi ₂ ; FW: 112.02; gray powdr.; m.p. 1220°; d. 4.75	10g 50g
26-2622	Iron(II) stearate (9% Fe) (2980-59-8) Fe(O ₂ C ₁₈ H ₃₅) ₂ ; FW: 622.81; orange powdr.	100g 500g
93-2638	Iron(II) sulfamate, (38-42%) aqueous solution (14017-39-1) Fe(NH ₂ SO ₃) ₂ ; FW: 248.02; green liq. <i>air sensitive</i> For detailed technical note visit strem.com .	250g 1kg
93-2639	Iron(II) sulfate heptahydrate, 99+% (ACS) (7782-63-0) FeSO ₄ ·7H ₂ O; FW: 151.96 (278.03); off-white powdr.; m.p. dec.; d. 2.970	250g 1kg
93-2623	Iron(III) sulfate hydrate, tech. gr. (15244-10-7) Fe ₂ (SO ₄) ₃ ·XH ₂ O; FW: 399.87; off-white powdr.	250g 1kg
93-2640	Iron(II) sulfide (99%-Fe) (1317-37-9) FeS; FW: 87.91; -60 + 200 mesh black powdr.	100g 500g 2kg
26-2635	Iron(II) sulfide (99.9%-Fe) (1317-37-9) FeS; FW: 87.91; -100 mesh black powdr.	10g 50g
93-2633	Iron(II) tetrafluoroborate, 40-45% aqueous solution (15283-51-9) Fe(BF ₄) ₂ ; FW: 229.45; green liq. <i>air sensitive</i>	50g 250g
26-2880	Iron(III) meso-tetraphenylporphine chloride (16456-81-8) Fe(C ₄₄ H ₂₈ N ₄)Cl; FW: 704.03; purple xtl.	500mg 2g
26-3900	Iron(III) meso-tetraphenylporphine-μ-oxo dimer (12582-61-5) [(C ₄₄ H ₂₈ N ₄)Fe] ₂ O; FW: 1353.16; purple xtl.	500mg 2g
93-2644	Iron(III) trifluoroacetylacetonate, 99% (99.9%-Fe) (14526-22-8) Fe(CF ₃ C(O)CHC(O)CF ₃) ₃ ; FW: 515.09; red xtl.; m.p. 110-112°	5g 25g
26-2830 HAZ	Iron(II) trifluoromethanesulfonate, 98% (Iron triflate) (59163-91-6) Fe(CF ₃ SO ₃) ₂ ; FW: 353.99; off-white to brown powdr. <i>hygroscopic</i>	25g 100g

IRON (Compounds)

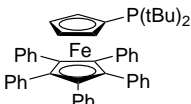
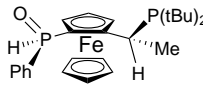
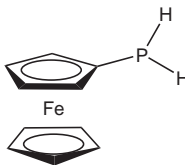
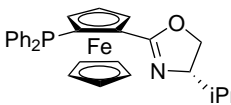
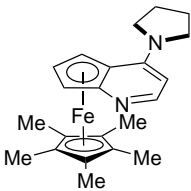
26-3525	Pentamethylcyclopentadienyliron dicarbonyl dimer, min. 98% (35344-11-7) [(CH ₃) ₅ C ₅ Fe(CO) ₂] ₂ ; FW: 494.20; red to purple xtl.		1g 5g
26-3575	1,2,3,4,5-Pentaphenyl-1'-(di-t-butylphosphino)ferrocene, 95% CTC-Q-PHOS (312959-24-3) C ₄₈ H ₄₇ FeP; FW: 710.71; pink powdr. Note: Sold in collaboration with Johnson Matthey for research purposes only. Patent Application No WO 02/11883. For detailed technical note visit strem.com .		100mg 500mg 2g 10g
26-1269	(S, R(p), S(SPO)-1-Phenylphosphinoyl)-2-[1-(t-butylphosphino)ethyl]ferrocene, min. 97% JoSPOphos (1221746-56-0) C ₂₆ H ₃₆ FeOP ₂ ; FW: 482.36; orange powdr. (store cold) Note: Sold in collaboration with Solvias for research purposes only. For detailed technical note visit strem.com .		100mg 500mg 2g 10g
26-1268	(R,S(p), R(SPO)-1-Phenylphosphinoyl)-2-[1-(di-t-butylphosphino)ethyl]ferrocene, min. 97% JoSPOphos (1221746-66-2) C ₂₆ H ₃₆ FeOP ₂ ; FW: 482.36; orange powdr. (store cold) Note: Sold in collaboration with Solvias for research purposes only. For detailed technical note visit strem.com .		100mg 500mg 2g 10g
26-3620	Phosphinoferrocene, 98% (83528-85-2) C ₁₀ H ₁₁ FeP; FW: 218.01; red-brown solid <i>air sensitive</i> For detailed technical note visit strem.com .		1g 5g
26-4011	(R,R)-[2-(4'-i-Propyloxazolin-2'-yl)ferrocenyl] diphenylphosphine, min. 97% (541540-70-9) C ₂₈ H ₂₈ FeNOP; FW: 481.35; orange solid <i>air sensitive</i>		100mg 500mg
26-4010	(S,S)-[2-(4'-i-Propyloxazolin-2'-yl)ferrocenyl]diphenylphosphine, min. 97% (163169-29-7) C ₂₈ H ₂₈ FeNOP; FW: 481.35; orange solid <i>air sensitive</i>		100mg 500mg
26-3700	(R)-(+)-4-Pyrrolidinopyrindinyl(pentamethylcyclopentadienyl) iron, min. 98% (R)-PPY* (217459-10-4) C ₂₂ H ₂₈ FeN ₂ ; FW: 376.30; dark red xtl.; m.p. 163-164° Note: Limited quantities available. For detailed technical note visit strem.com .		100mg
26-3701	(S)-(-)-4-Pyrrolidinopyrindinyl(pentamethylcyclopentadienyl)iron, min. 98% (S)-PPY* (217459-11-5) C ₂₂ H ₂₈ FeN ₂ ; FW: 376.30; dark red xtl.; m.p. 163-164° Note: Limited quantities available.		100mg
Technical Note: 1. See 26-3700 (page 110)			
96-3650	Solvias Josiphos Ligand Kit See page 520		
96-3652	Solvias MandyPhos™ Ligand Kit See page 521		
96-3651	Solvias Walphos Ligand Kit See page 522		

IRON (Compounds)

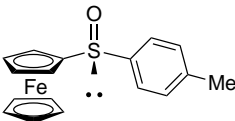
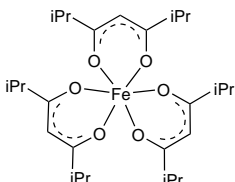
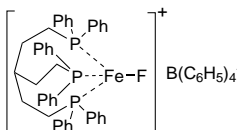
26-3765	Tetramethylammonium ferricyanide, 98% (14591-44-7) C ₁₈ H ₃₆ FeN ₉ ; FW: 434.38; yellow xtl.	100mg 500mg
NEW		
26-3705	(R)-(-)-(p-Toluenesulfinyl)ferrocene, min. 98% (130225-27-3) C ₁₇ H ₁₆ FeOS; FW: 324.22; orange powder; m.p. 143°	100mg 500mg
		
Technical Note: 1. Starting material for the synthesis of a variety of ferrocene-based catalysts.		
References: 1. <i>Org. Lett.</i> , 2007 , 9, 3089 2. <i>J. Org. Chem.</i> , 2005 , 70, 8332 3. <i>Angew. Chem. Int. Ed.</i> , 2002 , 41, 4708		
26-3706	(S)-(+)-(p-Toluenesulfinyl)ferrocene, min. 98% (164297-25-0) C ₁₇ H ₁₆ FeOS; FW: 324.22; orange powder; m.p. 143°	100mg 500mg
Technical Note: 1. See 26-3705 (page 111)		
26-3915	Tris(2,6-dimethyl-3,5-heptanedionato)iron(III), 98% Fe(dibm)3 (24444-72-2) C ₂₇ H ₄₅ FeO ₆ ; FW: 521.49; red-orange xtl. For detailed technical note visit strem.com .	500mg 2g 10g
NEW		
		
26-3955	Tris[(2-(diphenylphosphino)ethyl)phosphine](fluoro)iron(II) tetraphenylborate, min. 98% (1318882-57-3) C ₆₆ H ₆₂ FeBFP ₄ ; FW: 1064.75; purple solid	100mg 500mg
NEW		
		
26-3910	Tris(2,2,6,6-tetramethyl-3,5-heptanedionato)iron(III), 99% (99.9%-Fe) [Fe(TM-HD)₃] (14876-47-2) Fe(C ₁₁ H ₁₉ O ₂) ₃ ; FW: 605.66; red xtl.; m.p. 164°; b.p. dec. 300°	1g 5g 25g
26-3950	Vinylferrocene, 99% (1271-51-8) CH ₂ =CHC ₅ H ₄ FeC ₅ H ₅ ; FW: 212.07; orange xtl.; m.p. 49-51°	1g 5g

LANTHANUM (Elemental Forms)

93-5746	Lanthanum chips (99.6% REO) (7439-91-0) HAZ La; FW: 138.90; (packed in mineral oil); m.p. 920°; b.p. 3454°; d. 6.166 <i>air sensitive, moisture sensitive</i>	25g 100g
93-5750	Lanthanum foil (99.9% REO) (7439-91-0) HAZ La; FW: 138.90; 0.62 mm thick (~2.4g/25 x 25 mm) (packed in mineral oil); m.p. 920°; b.p. 3454°; d. 6.166 <i>air sensitive, moisture sensitive</i>	25 x 25mm 50 x 50mm
57-5747	Lanthanum ingot (99.9% REO) (7439-91-0) HAZ La; FW: 138.90; packed in mineral oil; m.p. 920°; b.p. 3454°; d. 6.166 <i>air sensitive, moisture sensitive</i> For detailed technical note visit strem.com .	25g 100g
93-5745	Lanthanum powder (99.9% REO) (7439-91-0) HAZ La; FW: 138.90; -325 mesh (packed in mineral oil); b.p. 3454°; d. 6.166 <i>air sensitive, moisture sensitive</i>	10g 50g

LANTHANUM (Compounds)

57-0201	Di-[-3-(S)-2,2'-dihydroxy-1,1'-binaphthylmethyl]ether, lanthanum(III) salt, tetrahydrofuran adduct SCT-(S)-BINOL (293293-33-1) C ₄₂ H ₂₇ LaO ₅ ·C ₄ H ₈ O; FW: 750.58 (822.69); pale yellow powder. For detailed technical note visit strem.com .	100mg
----------------	--	-------

LANTHANUM (Compounds)

93-5701	Lanthanum(III) acetate hydrate (99.9%-La) (REO) (100587-90-4) La(OOCCCH ₃) ₃ ·XH ₂ O; FW: 316.05; white xtl.	100g 500g
93-5702	Lanthanum(III) acetylacetonate hydrate (99.9%-La) (REO) (64424-12-0) La(CH ₃ C(O)CHC(O)CH ₃) ₃ ·XH ₂ O; FW: 436.24; white to off-white pwdr.	25g 100g
57-0500	Lanthanum(III) aluminum oxide (12003-65-5) LaAlO ₃ ; FW: 213.88; white pwdr.	5g 25g
93-5735	Lanthanum boride (99%-La) (12008-21-8) LaB ₆ ; FW: 203.78; purple to black pwdr.; m.p. 2210°; d. 2.61	10g 50g
57-0505	Lanthanum(III) bromide, anhydrous (99.99%-La) (REO) PURATREM (13536-79-3) LaBr ₃ ; FW: 378.62; white xtl. <i>air sensitive, moisture sensitive</i>	2g 10g
93-5730	Lanthanum(III) bromide heptahydrate (99.9%-La) (REO) (13465-19-5) LaBr ₃ ·7H ₂ O; FW: 378.63 (504.74); white xtl.	5g 25g
93-5707	Lanthanum(III) carbonate hydrate (99.9%-La) (REO) (6487-39-4) La ₂ (CO ₃) ₃ ·XH ₂ O; FW: 457.85; white pwdr.; d. 2.6-2.7	100g 500g
93-5708	Lanthanum(III) chloride, anhydrous (99.9%-La) (REO) (10099-58-8) LaCl ₃ ; FW: 245.27; white pwdr.; m.p. 860°; b.p. 1000°; d. 3.842 <i>hygroscopic</i>	25g 100g
93-5731	Lanthanum(III) chloride hexahydrate (99.9%-La) (REO) (17272-45-6) LaCl ₃ ·6H ₂ O; FW: 245.27 (353.36); white xtl.; m.p. 91° dec.	100g 500g
57-5731	Lanthanum(III) chloride hydrate (99.999%-La) (REO) PURATREM (10025-84-0) LaCl ₃ ·XH ₂ O; FW: 245.27; white xtl.; m.p. 91° dec. <i>hygroscopic</i>	25g 100g
57-5730	Lanthanum(III) chloride hydrate (99.999%-La) (low Ca, Fe, Mg) PURATREM (10025-84-0) LaCl ₃ ·XH ₂ O; FW: 245.27; white xtl.; m.p. 91° dec. <i>hygroscopic</i>	25g 100g
93-5710	Lanthanum(III) fluoride, anhydrous (99.9%-La) (REO) (13709-38-1) LaF ₃ ; FW: 195.90; white pwdr.; m.p. 1493°; d. 5.936 <i>hygroscopic</i>	25g 100g
57-2000	Lanthanum(III) fluoride, anhydrous (99.99%-La) (REO) PURATREM (13709-38-1) LaF ₃ ; FW: 195.90; white lumps; m.p. 1493°; d. 5.936 <i>hygroscopic</i>	25g 100g
93-5711	Lanthanum(III) hydroxide, anhydrous (99.9%-La) (REO) (14507-19-8) La(OH) ₃ ; FW: 189.93; white pwdr.	10g 50g
93-5712	Lanthanum(III) iodide, anhydrous (99.9%-La) (REO) (13813-22-4) LaI ₃ ; FW: 519.62; off-white to red pwdr.; m.p. 772°; d. 5.63 <i>hygroscopic</i>	1g 5g
93-5713 HAZ	Lanthanum(III) nitrate hexahydrate (99.9%-La) (REO) (10277-43-7) La(NO ₃) ₃ ·6H ₂ O; FW: 324.93 (433.02); white xtl.; m.p. 40°; b.p. 126° dec. <i>hygroscopic</i>	100g 500g
93-5732 HAZ	Lanthanum(III) nitrate hexahydrate (99.99%-La) (REO) PURATREM (10277-43-7) La(NO ₃) ₃ ·6H ₂ O; FW: 324.93 (433.02); white xtl.; m.p. 40°; b.p. 126° dec. <i>hygroscopic</i>	25g 100g 500g
57-5732 HAZ	Lanthanum(III) nitrate hexahydrate (99.999%-La) (REO) PURATREM (10277-43-7) La(NO ₃) ₃ ·6H ₂ O; FW: 324.93 (433.02); white xtl.; m.p. 40°; b.p. 126° dec.	25g 100g
93-5740	Lanthanum(III) oxide (99.9%-La) (REO) (1312-81-8) La ₂ O ₃ ; FW: 325.82; white pwdr.; m.p. 2315°; b.p. 4200°; d. 6.51	50g 250g 1kg
93-5716	Lanthanum(III) oxide (99.99%-La) (REO) PURATREM (1312-81-8) La ₂ O ₃ ; FW: 325.82; white pwdr.; m.p. 2315°; b.p. 4200°; d. 6.51	100g 500g
93-5741	Lanthanum(III) oxide (99.999%-La) (REO) PURATREM (1312-81-8) La ₂ O ₃ ; FW: 325.82; white pwdr.; m.p. 2315°; b.p. 4200°; d. 6.51	25g 100g

LANTHANUM (Compounds)

93-5733 HAZ	Lanthanum(III) perchlorate hexahydrate (36907-37-6) La(ClO ₄) ₃ ·6H ₂ O; FW: 437.26 (545.35); white xtl. <i>hygroscopic</i>	10g 50g 250g
93-5717	Lanthanum(III) phosphate hydrate (14913-14-5) LaPO ₄ ·xH ₂ O; FW: 233.88; white powdr.	25g 100g
57-2550	Lanthanum(III) i-propoxide, 99% (99.9%-La) (REO) (19446-52-7) La(OC ₃ H ₇) ₃ ; FW: 316.17; white to off-white powdr. <i>moisture sensitive</i>	1g 5g
93-5720	Lanthanum(III) sulfate hydrate (99.9%-La) (REO) (57804-25-8) La ₂ (SO ₄) ₃ ·xH ₂ O; FW: 566.00; white xtl.; m.p. dec.; d. 2.821	50g 250g
93-5721	Lanthanum(III) sulfide (99.9%-La) (REO) (12031-49-1) La ₂ S ₃ ; FW: 374.01; yellow powdr.; m.p. 2100-2150°; d. 4.911	5g 25g
57-2800	Lanthanum(III) trifluoromethanesulfonate, min. 97% (Lanthanum triflate) (52093-26-2) La(SO ₂ CF ₃) ₃ ; FW: 586.11; white powdr. <i>hygroscopic</i>	2g 10g 50g
57-0510 amp	Tris(N,N-bis(trimethylsilyl)amide)lanthanum(III), min. 98% (99.9%-La) (REO) (175923-07-6) {[(CH ₃) ₃ Si]N ₂ } ₃ La; FW: 620.06; white powdr. <i>air sensitive, moisture sensitive, (store cold)</i> For detailed technical note visit strem.com .	1g 5g
57-3000 amp	Tris(cyclopentadienyl)lanthanum (99.9%-La) (REO) (1272-23-7) (C ₅ H ₅) ₃ La; FW: 334.19; white to off-white xtl.; m.p. 295° dec. <i>air sensitive, moisture sensitive</i>	1g 5g
57-1200 NEW amp HAZ	Tris(N,N-di-i-propylformamidinato)lanthanum(III), (99.999%-La) PURATREM La-FMD (1034537-36-4) C ₂₁ H ₄₅ LaN ₆ ; FW: 520.53; white to off-white powdr. <i>air sensitive, moisture sensitive</i> Note: Product sold under, use subject to, terms and conditions of label license at www.strem.com/harvard2 . For detailed technical note visit strem.com .	1g 5g
57-3500	Tris(6,6,7,7,8,8,8-heptafluoro-2,2-dimethyl-3,5-octanedionato)lanthanum(III), 99% (99.9%-La) (REO) [La(FOD)₃] (19106-89-9) La(C ₈ F ₇ C(O)CHC(O)C ₄ H ₉) ₃ ; FW: 1024.44; white powdr.	1g 5g
57-4000 amp	Tris(i-propylcyclopentadienyl)lanthanum (99.9%-La) (REO) (68959-87-5) (C ₃ H ₇ C ₅ H ₉) ₃ La; FW: 460.43; colorless to pale yellow liq.; b.p. 180-195°/0.02mm <i>air sensitive, moisture sensitive</i>	1g 5g 25g
57-1000	Tris(2,2,6,6-tetramethyl-3,5-heptanedionato)lanthanum(III), 99% (99.9%-La) (REO) [La(TMHD)₃] (14319-13-2) La(C ₁₁ H ₁₉ O ₂) ₃ ; FW: 688.72; white powdr.; m.p. 227-231°; b.p. dec. 370° (subl. 210°/0.2mm)	1g 5g 25g
57-1100	Tris(2,2,6,6-tetramethyl-3,5-heptanedionato)lanthanum(III) tetraglyme adduct (99.9%-La) (REO) (151139-14-9) La(C ₁₁ H ₁₉ O ₂) ₃ ·CH ₃ (OCH ₂ CH ₂) ₄ OCH ₃ ; FW: 688.72 (911.00); white to pale-yellow xtl.; m.p. 59°; b.p. 125°/0.1mm	1g 5g 25g

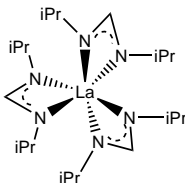
**LEAD (Elemental Forms)**

93-8271	Lead granules (99.9+%) (7439-92-1) Pb; FW: 207.21; -20 mesh; m.p. 327.43°; b.p. 1620°; d. 11.288	100g 500g
82-0050	Lead granules (99.999%) (7439-92-1) Pb; FW: 207.21; 1-3 mm; m.p. 327.43°; b.p. 1620°; d. 11.288	50g 250g
93-8273 HAZ	Lead powder (99.5%) (7439-92-1) Pb; FW: 207.21; -100 mesh; m.p. 327.43°; b.p. 1620°; d. 11.288	250g 1kg
82-0100	Lead rod (99.999%) (7439-92-1) Pb; FW: 207.21; 10 mm dia. (~50g/5.6 cm); m.p. 327.43°; b.p. 1620°; d. 11.288	50g 250g 1kg
82-0200	Lead wire (99.9995%) (7439-92-1) Pb; FW: 207.21; 0.75mm dia. (-5g/m); m.p. 327.43°; b.p. 1620°; d. 11.288	2m 10m

LEAD (Compounds)

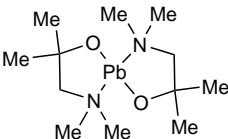
82-2155	Bis(1-dimethylamino-2-methyl-2-propanolate) lead(II), 98% Pb(DMAMP)₂ (934302-16-6) C ₁₂ H ₂₈ N ₄ O ₂ Pb; FW: 439.56; white solid For detailed technical note visit strem.com .		250mg 1g 5g
82-2100	Bis(2,2,6,6-tetramethyl-3,5-heptanedionato)lead(II), 99% [Pb(TMHD)₂] (21319-43-7) Pb(C ₁₁ H ₁₉ O ₂) ₂ ; FW: 573.75; white powdr.; m.p. 126-128°; b.p. 325° dec. (subl. 134°/0.1mm)		1g 5g 25g
82-0580	Hexaphenyldilead, min. 98% (3124-01-4) (C ₆ H ₅) ₃ PbPb(C ₆ H ₅) ₃ ; FW: 877.04; white xtl.; m.p. 170° dec.		1g 5g
93-8250	Lead(II) acetate trihydrate, 99+% (ACS) (6080-56-4) HAZ Pb(OOCCH ₃) ₂ ·3H ₂ O; FW: 325.28 (379.33); white powdr.; m.p. 75° dec.; d. 2.55		250g 1kg
82-0595	Lead(II) acetate trihydrate (99.999%-Pb) PURATREM (6080-56-4) HAZ Pb(OOCCH ₃) ₂ ·3H ₂ O; FW: 325.28 (379.33); white xtl.; m.p. 75° dec.; d. 2.55		25g 100g
93-8270	Lead(IV) acetate, 95% (546-67-8) HAZ Pb(OOCCH ₃) ₄ ; FW: 443.37; white to light brown xtl.; m.p. 175°; d. 2.28 <i>moisture sensitive, (store cold)</i>		50g 250g
93-8251	Lead(II) acetylacetonate, min. 95% (15282-88-9) Pb(CH ₃ COCHCOCH ₃) ₂ ; FW: 405.41; white powdr. <i>hygroscopic</i>		5g 25g 100g
93-8201	Lead antimonide, 99+% (12266-38-5) PbSb; FW: 328.94; gray pieces		5g 25g
93-8203	Lead(II) bromide, 98+% (10031-22-8) PbBr ₂ ; FW: 367.01; white powdr.; m.p. 373°; b.p. 916°; d. 6.66		50g 250g
93-8206	Lead(II) chloride, 99% (7758-95-4) HAZ PbCl ₂ ; FW: 278.10; white powdr.; m.p. 501°; b.p. 950°; d. 5.85		100g 500g
82-0600	Lead(II) citrate trihydrate, min. 97% (512-26-5) Pb ₃ (C ₆ H ₅ O ₇) ₂ ·3H ₂ O; FW: 999.77 (1053.82); white powdr. Note: For sale in USA. For other countries contact Strem.		25g 100g
93-8224	Lead(II) 2-ethylhexanoate (40.5%-42.5% Pb) (301-08-6) Pb[OOCCH(C ₂ H ₅)C ₄ H ₉] ₂ ; FW: 493.61; viscous liq.; f.p. 324°F; d. 1.56		250g 1kg
93-8214	Lead(II) fluoride, 99+% (7783-46-2) PbF ₂ ; FW: 245.19; white powdr.; m.p. 855°; b.p. 1290°; d. 8.24		100g 500g
93-8265	Lead(II) hexafluoroacetylacetonate, min. 98% (19648-88-5) Pb(CF ₃ C(O)CHC(O)CF ₃) ₂ ; FW: 621.29; white powdr.; m.p. 153-158°; b.p. dec. 210° (subl. 180°/0.05 mm)		1g 5g
93-8217	Lead(II) iodide, 98.5% (10101-63-0) HAZ PbI ₂ ; FW: 461.00; yellow powdr.; m.p. 402°; b.p. 954°; d. 6.16		50g
82-0750	Lead(II) iodide (99.999%-Pb) PURATREM (10101-63-0) HAZ PbI ₂ ; FW: 461.00; yellow powdr.; m.p. 402°; b.p. 954°; d. 6.16		10g 50g
93-8222	Lead(II) nitrate, 99+% (ACS) (10099-74-8) HAZ Pb(NO ₃) ₂ ; FW: 331.23; white xtl.; m.p. 470° dec.; d. 4.53 <i>hygroscopic</i>		250g 1kg
93-8267	Lead(II) nitrate (99.999%-Pb) PURATREM (10099-74-8) HAZ Pb(NO ₃) ₂ ; FW: 331.20; white xtl.; m.p. 470° dec.; d. 4.53 <i>hygroscopic</i>		25g 100g
93-8220	Lead(II) oxide (Litharge), 99+% (1317-36-8) PbO; FW: 223.19; yellow powdr.; m.p. 888°; d. 9.53		500g 2kg
93-8219	Lead(II) oxide (99.999%-Pb) PURATREM (1317-36-8) PbO; FW: 223.19; yellow powdr.; m.p. 888°; d. 9.53		10g 50g
93-8210	Lead(IV) oxide, 97+% (ACS) (1309-60-0) HAZ PbO ₂ ; FW: 239.19; red to brown powdr.; m.p. 290° dec.; d. 9.375		100g 500g
82-1600	Lead(II) perchlorate, trihydrate, 97+% (ACS) (13453-62-8) HAZ Pb(ClO ₄) ₂ ·3H ₂ O; FW: 406.10(460.15); white xtl. <i>hygroscopic</i>		100g 500g



LEAD (Compounds)

93-8257 HAZ	Lead(II) selenide (99.99%-Pb) PURATREM (12069-00-0) PbSe; FW: 286.15; gray to black pieces; m.p. 1065°; d. 8.10	5g 25g
93-8232	Lead(II) sulfate, 99% (7446-14-2) PbSO ₄ ; FW: 303.25; white powdr.; m.p. 1170°; d. 6.2	250g 1kg
93-8233	Lead(II) sulfide (99.999%-Pb) PURATREM (1314-87-0) PbS; FW: 239.25; black powdr.; m.p. 1114°; d. 7.5	5g 25g
	Lead sulfide CANdot® quantum dots (10 mg/mL in toluene) (1314-87-0) See page 161	
93-8237 HAZ	Lead(II) titanate, 99.5% (12060-00-3) PbTiO ₃ ; FW: 303.09; off-white powdr.; d. 7.5	250g 1kg
93-8239	Lead(II) zirconate, 99% (12060-01-4) PbZrO ₃ ; FW: 346.42; off-white powdr.; d. 7.0	100g 500g
82-2180 NEW HAZ	Methylammonium triiodoplumbate(II) (40wt% solution in DMF) (99.99+%-Pb) (69507-98-8) [CH ₃ NH ₃] ⁺ PbI ₃ ; FW: 616.96; clear yellow liq.; d. 1.368	2g 10g
82-2150	Tetraphenyllead, min. 97% (595-89-1) (C ₆ H ₅) ₄ Pb; FW: 515.61; white xtl.; m.p. 229-230°; b.p. 325° dec. (subl. 230°/0.05 mm); d. 1.530	1g 5g 25g





LITHIUM (Elemental Forms)

03-0375 HAZ	Lithium granules (99+%) (7439-93-2) Li; FW: 6.94; 2.5mm granules; m.p. 179°; b.p. 1317°; d. 0.534 <i>air sensitive, moisture sensitive</i>	50g 250g
93-0369 HAZ	Lithium ribbon (99.8%) (7439-93-2) Li; FW: 6.94; 100 mm wide x 1.5 mm thick; m.p. 179°; b.p. 1317°; d. 0.534 <i>air sensitive, moisture sensitive</i>	25g 100g
93-0359 HAZ	Lithium rod (99.8%) (7439-93-2) Li; FW: 6.94; 1.27 cm dia. (packed in mineral oil) (~0.67g/cm); m.p. 179°; b.p. 1317°; d. 0.534 <i>air sensitive, moisture sensitive</i>	50g 250g

LITHIUM (Compounds)

93-0389 HAZ 	s-Butyllithium, 12% in cyclohexane (1.4M) (598-30-1) C ₄ H ₉ Li; FW: 64.05; cloudy liq.; f.p. 1°F <i>moisture sensitive, pyrophoric, (store cold)</i> Note: Free rubber septum included.	0.25mole 1mole
93-0301 HAZ 	n-Butyllithium, 15% in hexanes (1.6M) (109-72-8) C ₄ H ₉ Li; FW: 64.05; slightly cloudy liq.; d. 0.680 <i>moisture sensitive, pyrophoric, (store cold)</i> Note: Free rubber septum included.	0.25mole 1mole
93-0302 HAZ 	t-Butyllithium 16% in pentane (1-2M) (594-19-4) C ₄ H ₉ Li; FW: 64.05; slightly cloudy liq. <i>moisture sensitive, pyrophoric, (store cold)</i> Note: Free rubber septum included.	0.25mole 1mole
93-0362	Lithium acetate dihydrate, 98% (99.9%-Li) (6108-17-4) LiOOCCH ₃ ·2H ₂ O; FW: 65.98 (102.01); white powdr.; m.p. dec.; d. 1.3	250g 1kg
93-0361	Lithium acetylacetonate, 98+% (18115-70-3) LiCH ₃ C(O)CHC(O)CH ₃ ; FW: 106.05; white powdr.; m.p. ~250° <i>hygroscopic</i>	10g 50g
03-0750 HAZ	Lithium aluminum deuteride, 98% isotopic purity (14128-54-2) LiAlD ₄ ; FW: 41.99; gray powdr.; m.p. 175° dec. <i>air sensitive, moisture sensitive</i>	1g
93-0393 HAZ	Lithium aluminum hydride, powder, 95% (16853-85-3) LiAlH ₄ ; FW: 37.94; gray powdr.; m.p. 125° dec.; d. 0.917 <i>air sensitive, moisture sensitive</i>	10g 50g 250g 1kg

LITHIUM (Compounds)

03-0753 HAZ	Lithium aluminum hydride 2.2M (10wt% ±1wt%) in 2-methyltetrahydrofuran (16853-85-3) LiAlH ₄ ; FW: 37.94; liq. <i>air sensitive, moisture sensitive</i> Note: A product of Rockwood Lithium. Sold for R&D purposes only.	0.05mole 0.25mole
93-0306 HAZ	Lithium amide, 95% (7782-89-0) LiNH ₂ ; FW: 22.96; off-white powdr.; m.p. 373-375°; d. 1.178 <i>air sensitive, moisture sensitive</i>	50g 250g
93-0308	Lithium benzoate, 99+% (553-54-8) LiOOCCH ₂ CH ₃ ; FW: 128.06; white powdr.	100g 500g
93-0397 HAZ	Lithium borohydride, 95% (16949-15-8) LiBH ₄ ; FW: 21.78; white powdr.; m.p. 279° dec.; d. 0.66 <i>moisture sensitive</i>	1g 5g 25g
93-0372	Lithium bromide, anhydrous, 99+% (7550-35-8) LiBr; FW: 86.85; white powdr.; m.p. 550°; b.p. 1265°; d. 3.46 <i>hygroscopic</i>	250g 1kg
97-7223	Lithium bromide (99.95%-Li) (0.2% H₂O) (7550-35-8) LiBr; FW: 86.85; white powdr.; m.p. 550°; b.p. 1265°; d. 3.46 <i>hygroscopic</i>	10g 50g 250g
93-0371	Lithium bromide hydrate, 99% (13453-70-8) LiBr·XH ₂ O; FW: 86.85; white powdr.	50g 250g
03-0780 HAZ	Lithium t-butoxide, 98+% (1907-33-1) LiOC ₄ H ₉ ; FW: 80.06; off-white powdr.; d. 0.89 <i>moisture sensitive</i>	25g 100g
93-0311	Lithium carbonate, 99% (554-13-2) Li ₂ CO ₃ ; FW: 73.89; white powdr.; m.p. 723°; b.p. 1310° dec.; d. 2.11	250g 1kg
93-0312	Lithium carbonate (99.99%-Li) PURATREM (554-13-2) Li ₂ CO ₃ ; FW: 73.89; white powdr.; m.p. 723°; b.p. 1310° dec.; d. 2.11	25g 100g
03-0800	Lithium carbonate (99.999%-Li) PURATREM (554-13-2) Li ₂ CO ₃ ; FW: 73.89; white powdr.; m.p. 723°; b.p. 1310° dec.; d. 2.11	25g 100g
93-0313	Lithium chloride, 99% (ACS) (7447-41-8) LiCl; FW: 42.39; white powdr.; m.p. 614°; b.p. 1325-1360°; d. 2.068 <i>hygroscopic</i>	250g 1kg
03-0900	Lithium chloride hydrate (99.996%-Li) PURATREM (16712-20-2) LiCl·XH ₂ O; FW: 42.39; white xtl.	10g 50g
93-0314 HAZ	Lithium chromate, min. 95% (14307-35-8) Li ₂ CrO ₄ ; FW: 129.87; yellow xtl.	250g
93-0386	Lithium cobalt(III) oxide, min. 98% (12190-79-3) LiCoO ₂ ; FW: 97.87; dark gray powdr.	50g 250g
03-1000 HAZ	Lithium cyclopentadienide, 97% (16733-97-4) C ₅ H ₅ Li; FW: 72.04; off-white powdr. <i>air sensitive, moisture sensitive</i>	5g 25g
93-0374 HAZ	Lithium deuteride, 99+% isotopic purity (13587-16-1) LiD; FW: 8.95; off-white powdr.; m.p. ~680°; d. 0.820 <i>air sensitive, moisture sensitive</i>	1g 5g
93-0317 HAZ  	Lithium diethylamide, 95+% (816-43-3) LiN(C ₂ H ₅) ₂ ; FW: 79.07; off-white to light-orange solid <i>moisture sensitive, pyrophoric</i>	5g 25g
93-0383	Lithium dihydrogen phosphate, 97% (13453-80-0) LiH ₂ PO ₄ ; FW: 103.93; white powdr.; d. 2.461	100g 500g
93-0318 HAZ  	Lithium dimethylamide, 95% (3585-33-9) LiN(CH ₃) ₂ ; FW: 51.02; off-white powdr.; m.p. dec. <i>moisture sensitive, pyrophoric</i>	5g 25g
03-1180	Lithium dodecyl sulfate, min. 98% (2044-56-6) See page 168	

LITHIUM (Compounds)

93-0341	Lithium 2-ethylhexanoate, min. 98% (15590-62-2) LiOOCCH(C ₂ H ₅)C ₄ H ₉ ; FW: 150.15; off-white powdr.	5g 25g
93-0322 HAZ	Lithium fluoride, 99+% (7789-24-4) LiF; FW: 25.94; white powdr.; m.p. 842°; b.p. 1672°; d. 2.635	250g 1kg
93-0321 HAZ	Lithium fluoride, 99.9% (99.9%-Li) (7789-24-4) LiF; FW: 25.94; white xtl.; m.p. 842°; b.p. 1672°; d. 2.635	10g 50g 250g
93-0320 HAZ	Lithium fluoride (99.9%-Li) (7789-24-4) LiF; FW: 25.94; 3-6mm pieces; m.p. 842°; b.p. 1672°; d. 2.635	10g 50g
93-0323	Lithium formate hydrate (6108-23-2) LiOOC·XH ₂ O; FW: 51.95; white powdr.	100g 500g
03-1200 HAZ	Lithium hexafluoroantimonate, min. 97% (18424-17-4) LiSbF ₆ ; FW: 242.68; white to off-white powdr. <i>hygroscopic</i>	5g 25g
03-1250	Lithium hexafluoroarsenate(V) (99.9%-As) (29935-35-1) LiAsF ₆ ; FW: 195.85; white powdr. <i>hygroscopic</i>	5g 25g
93-0325 HAZ	Lithium hexafluorophosphate, 99+% (21324-40-3) LiPF ₆ ; FW: 151.92; white to off-white powdr. <i>hygroscopic</i>	5g 25g
03-0325 HAZ	Lithium hexafluorophosphate (99.9%-Li) (21324-40-3) LiPF ₆ ; FW: 151.92; white xtl. <i>hygroscopic</i>	10g 50g 250g
93-0327	Lithium hexafluorostannate(IV), 99% (17029-16-2) Li ₂ SnF ₆ ; FW: 246.56; white powdr.	5g 25g
93-0328 HAZ	Lithium hydride, min. 95% (7580-67-8) LiH; FW: 7.95; gray powdr. <i>air sensitive, moisture sensitive</i>	50g 250g
93-0330 HAZ	Lithium hydroxide, anhydrous, 95% (1310-65-2) LiOH; FW: 23.95; white powdr.; m.p. 450°; b.p. 925°; d. 1.46 <i>hygroscopic</i>	50g 250g
93-0329 HAZ	Lithium hydroxide monohydrate, min. 98% (1310-66-3) LiOH·H ₂ O; FW: 23.95 (41.96); white powdr. <i>hygroscopic</i>	500g 2kg
93-0382 amp	Lithium iodide, anhydrous, min. 98% (10377-51-2) LiI; FW: 133.84; white to off-white powdr.; m.p. 450°; b.p. 1180°; d. 3.494 <i>hygroscopic</i>	25g 100g
93-0381	Lithium iodide trihydrate, 99+% (7790-22-9) LiI·3H ₂ O; FW: 133.84 (187.89); colorless to yellow xtl.; d. 3.43 <i>hygroscopic</i>	50g 250g
93-0334	Lithium metaborate, anhydrous, (99.9%-Li) (13453-69-5) LiBO ₂ ; FW: 49.75; white powdr.; m.p. 845°; d. 1.4 <i>hygroscopic</i>	50g 250g
93-0370	Lithium metaborate dihydrate (15293-74-0) LiBO ₂ ·2H ₂ O; FW: 49.75 (85.78); white powdr.; d. 1.8	100g 500g
93-0377	Lithium metasilicate, 99% (10102-24-6) Li ₂ SiO ₃ ; FW: 89.94; white powdr.; m.p. 1201°; d. 2.52	50g 250g
93-0335 HAZ	Lithium methoxide, 10% in methanol (865-34-9) LiOCH ₃ ; FW: 37.97; colorless liq.; f.p. 52°F (methanol) <i>moisture sensitive</i>	100g 500g
93-0336 HAZ	Lithium methoxide, min. 95% (865-34-9) LiOCH ₃ ; FW: 37.97; white powdr.; m.p. 500° <i>moisture sensitive</i>	50g 250g
03-0784 HAZ	Lithium 2-methyl-2-butoxide 3.1M (40wt% ±1wt%) in heptane (53535-81-2) [CH ₃ CH ₂ (CH ₂) ₂ CO] ₂ Li; FW: 94.08; liq. <i>air sensitive, moisture sensitive</i> Note: A product of Rockwood Lithium. Sold for R&D purposes only.	0.25mole
93-0337	Lithium molybdate, 99% (13568-40-6) Li ₂ MoO ₄ ; FW: 173.82; white powdr.; m.p. 705°; d. 2.66	100g 500g

LITHIUM (Compounds)

93-0338	Lithium niobate (99.998%-Nb) PURATREM (12031-63-9) LiNbO ₃ ; FW: 147.85; white powdr.	25g 100g
93-0339 HAZ	Lithium nitrate, anhydrous, 99% (7790-69-4) LiNO ₃ ; FW: 68.94; white powdr. <i>hygroscopic</i>	250g 1kg
93-0340 HAZ	Lithium nitride (99.5%-Li) (26134-62-3) Li ₃ N; FW: 34.82; -60 mesh reddish-brown powdr.; m.p. 845°; d. 1.38 <i>moisture sensitive</i>	5g 25g
93-0349	Lithium orthophosphate, 98% (10377-52-3) Li ₃ PO ₄ ; FW: 115.79; white powdr.; m.p. 1205°; d. 2.54	100g 500g
03-0343 HAZ	Lithium oxide, min. 95% (99.5%-Li) (12057-24-8) Li ₂ O; FW: 29.88; white powdr.; m.p. 1427°; d. 2.013 <i>moisture sensitive</i>	25g 100g
03-1150 amp HAZ	Lithium pentamethylcyclopentadienide, min. 98% (51905-34-1) LiC ₁₀ H ₁₅ ; FW: 142.17; white to off-white powdr. <i>air sensitive, moisture sensitive</i>	1g 5g 25g
93-0345 HAZ	Lithium perchlorate, anhydrous, 95+% (ACS) (7791-03-9) LiClO ₄ ; FW: 106.39; white powdr.; m.p. 235°; b.p. 430°; d. 2.428 <i>hygroscopic</i>	50g 250g
93-0344 HAZ	Lithium perchlorate trihydrate, 98% (13453-78-6) LiClO ₄ ·3H ₂ O; FW: 106.39 (160.45); white powdr.; d. 1.841 <i>hygroscopic</i>	100g 500g
93-0353	Lithium stearate, min. 95% (4485-12-5) LiC ₁₈ H ₃₅ O ₂ ; FW: 290.41; white powdr.	250g 1kg
93-0378 HAZ	Lithium sulfide, 98% (99.9%-Li) (12136-58-2) Li ₂ S; FW: 45.95; off-white powdr.; m.p. > 900°; d. 1.66 <i>moisture sensitive</i>	5g 25g
93-0384	Lithium tantalate (99.998%-Ta) PURATREM (12031-66-2) LiTaO ₃ ; FW: 235.89; white powdr.	2g 10g
93-0355	Lithium tetraborate, 99% (12007-60-2) Li ₂ B ₄ O ₇ ; FW: 169.12; white powdr.; m.p. 917°	100g 500g
93-0365	Lithium tetraborate (99.998%-Li) PURATREM (12007-60-2) Li ₂ B ₄ O ₇ ; FW: 169.12; white powdr.; m.p. 917°	10g 50g
03-4500 HAZ	Lithium tetrachlorocuprate, 0.1M in THF (15489-27-7) Li ₂ CuCl ₄ ; FW: 219.24; orange liq.; b.p. 66° (THF) <i>moisture sensitive</i>	100ml 500ml
93-0356 HAZ	Lithium tetrafluoroborate, 98% (14283-07-9) LiBF ₄ ; FW: 93.75; white powdr.; m.p. dec. <i>hygroscopic</i>	10g 50g
03-4750 HAZ	Lithium tetramethylcyclopentadienide, min. 95% (82061-21-0) LiC ₉ H ₁₃ ; FW: 128.15; off-white to yellow powdr. <i>moisture sensitive</i>	1g 5g 25g
93-0572 HAZ	Lithium tetraphenylborate tris(1,2-dimethoxyethane)adduct, 98% (75965-35-4) LiB(C ₆ H ₅) ₄ ·3CH ₃ OCH ₂ CH ₂ OCH ₃ ; FW: 326.18 (596.54); white to off-white powdr. <i>moisture sensitive</i>	1g 5g
03-4850 HAZ	Lithium tri-t-butoxyaluminumhydride, ~1.0M in THF (17476-04-9) LiAl[OC(CH ₃) ₃] ₃ H; FW: 254.27; liq.; m.p. -108° (THF); b.p. 66° (THF) <i>air sensitive, moisture sensitive</i>	0.1mole 0.5mole
03-5000	Lithium trifluoroacetate monohydrate, min. 97% (2923-17-3) LiOCCF ₃ ·H ₂ O; FW: 119.96 (137.97); white powdr. <i>hygroscopic</i>	25g 100g
03-2000	Lithium trifluoromethanesulfonate, 99% (Lithium triflate) (33454-82-9) LiCF ₃ SO ₃ ; FW: 156.01; white powdr. <i>hygroscopic</i>	10g 50g

LITHIUM (Compounds)

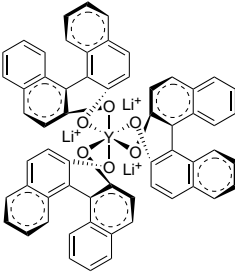
03-2010	Lithium tris(S-(-)-1,1'-binaphthyl-2,2'-diolato) yttrate(III) tetrahydrofuran adduct, min. 97% (500995-67-5) $3\text{Li}^+[(\text{C}_{20}\text{H}_{12}\text{O}_2)_3\text{Y}]^{3-} \cdot \text{XC}_4\text{H}_8\text{O}$; FW: 962.65; white powdr. <i>hygroscopic</i> For detailed technical note visit strem.com .		250mg 1g
93-0357	Lithium tungstate, 98% (13568-45-1) Li_2WO_4 ; FW: 261.73; white to off-white powdr.; m.p. 742°; d. 3.71		50g 250g
93-0358	Methyl lithium, complexed with lithium bromide in ethyl ether (1.5M) (917-54-4) $\text{CH}_3\text{Li} \cdot \text{LiBr}$; FW: 21.98 (108.82); colorless solution <i>moisture sensitive, pyrophoric, (store cold)</i> Note: Free rubber septum included.		0.25mole 1mole
03-5001	2,2,6,6-Tetramethyl-3,5-heptanedionato lithium, 98+% [Li(TMHD)] (22441-13-0) $\text{LiC}_{11}\text{H}_{19}\text{O}_2$; FW: 190.24; white powdr.; m.p. 265-268°; b.p. dec. 295°		1g 5g 25g

LUTETIUM (Elemental Forms)

71-0050	Lutetium foil (99.9% REO) (7439-94-3) Lu; FW: 174.97; 0.5mm thick (~3.1g/25 x 25mm); m.p. 1652°; b.p. 3327°; d. 9.842 <i>air sensitive</i>		25 x 25mm 50 x 50mm
71-0055	Lutetium foil (99.9% REO) (7439-94-3) Lu; FW: 174.97; 0.1mm thick (~0.62g/25 x 25mm); m.p. 1652°; b.p. 3327°; d. 9.842 <i>air sensitive</i>		25 x 25mm 50 x 50mm
71-0100	Lutetium ingot (99.9% REO) (7439-94-3) Lu; FW: 174.97; ingot; m.p. 1652°; b.p. 3327°; d. 9.842 <i>air sensitive</i> For detailed technical note visit strem.com .		1g 5g
71-0075	Lutetium powder (99.9% REO) (7439-94-3) HAZ Lu; FW: 174.97; -40 mesh; m.p. 1652°; b.p. 3327°; d. 9.842 <i>air sensitive</i>		1g

LUTETIUM (Compounds)

93-7110	Lutetium(III) acetate hydrate (99.9%-Lu) (REO) (18779-08-3) $\text{Lu}(\text{OOCCH}_3)_3 \cdot \text{XH}_2\text{O}$; FW: 352.11; white xtl.		1g 5g
93-7101	Lutetium(III) chloride, anhydrous (99.9%-Lu) (REO) (10099-66-8) LuCl_3 ; FW: 281.33; white powdr.; m.p. 905°; d. 3.98 <i>hygroscopic</i>		1g 5g
93-7111	Lutetium(III) chloride hexahydrate (99.9%-Lu) (REO) (15230-79-2) $\text{LuCl}_3 \cdot 6\text{H}_2\text{O}$; FW: 281.33 (389.42); white xtl.		1g 5g
93-7113	Lutetium(III) nitrate hydrate (99.9%-Lu) (REO) (10099-67-9) HAZ $\text{Lu}(\text{NO}_3)_3 \cdot \text{XH}_2\text{O}$; FW: 360.98; white xtl.		1g 5g
93-7102	Lutetium(III) oxide (99.9%-Lu) (REO) (12032-20-1) Lu_2O_3 ; FW: 397.94; white powdr.; m.p. 2487°; d. 9.41		1g 5g
93-7115	Lutetium(III) oxide (99.999%-Lu) (REO) PURATREM (12032-20-1) Lu_2O_3 ; FW: 397.94; white powdr.; m.p. 2487°; d. 9.41		1g 5g
93-7118	Lutetium(III) perchlorate, 50% aqueous solution (99.9%-Lu) (REO) (14646-29-8) HAZ $\text{Lu}(\text{ClO}_4)_3$; FW: 473.32; colorless liq.		2g 10g
93-7116	Lutetium(III) sulfate hydrate (99.9%-Lu) (REO) (13473-77-3) $\text{Lu}_2(\text{SO}_4)_3 \cdot \text{XH}_2\text{O}$; FW: 638.12; white xtl.		1g 5g
71-1000	Lutetium(III) trifluoromethanesulfonate, min. 98% (Lutetium triflate) (126857-69-0) $\text{Lu}(\text{CF}_3\text{SO}_3)_3$; FW: 622.18; white powdr. <i>hygroscopic</i>		500mg 2g

LUTETIUM (Compounds)

71-1050 **Tris(N,N'-di-i-propylacetamidinato)lutetium(III), 99%**
 amp Lu(C₈H₁₇N₂)₃; FW: 598.67; white to off-white powdr.
air sensitive, moisture sensitive
 Note: Product sold under, use subject to, terms and conditions of label license at www.strem.com/harvard2.

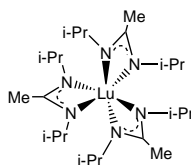

250mg
1g
5g

71-1080 **Tris(2,2,6,6-tetramethyl-3,5-heptanedionato)lutetium(III), 99% (99.9+%-Lu)**
(REO) [Lu(TMHD)₃] (15492-45-2)
 Lu(C₁₁H₁₉O₂)₃; FW: 724.76; off-white xtl.

NEW

1g
5g
25g

MAGNESIUM (Elemental Forms)

93-1299 **Magnesium chips (99+%) (7439-95-4)**
 HAZ Mg; FW: 24.32; -4 + 18 mesh; m.p. 657°; b.p. 1107°; d. 1.74

50g
250g
1kg

93-1298 **Magnesium powder (99%) (7439-95-4)**
 HAZ Mg; FW: 24.32; -325 mesh; m.p. 657°; b.p. 1107°; d. 1.74
 Note: For sale in USA. For other countries contact Strem.

100g
500g

93-1289 **Magnesium powder (99.8%) (7439-95-4)**
 HAZ Mg; FW: 24.32; -50 mesh; m.p. 657°; b.p. 1107°; d. 1.74

250g
1kg

93-1295 **Magnesium rod (99.8%) (7439-95-4)**
 HAZ Mg; FW: 24.32; ~454g/rod; 33 mm dia. x 305 mm long; m.p. 657°; b.p. 1107°; d. 1.74

1rod
5rods

93-1286 **Magnesium turnings for Grignards (99.8%) (7439-95-4)**
 HAZ Mg; FW: 24.32; turnings; m.p. 657°; b.p. 1107°; d. 1.74

100g
500g

MAGNESIUM (Compounds)

93-1201 **Allylmagnesium bromide, 0.95-1.1 M in ether (1730-25-2)**
 HAZ CH₂=CHCH₂MgBr; FW: 145.28; liq.
air sensitive, moisture sensitive
 Note: Free rubber septum included.

0.25mole

93-1202 **Benzylmagnesium chloride, 1-2 M in THF (6921-34-2)**
 HAZ C₆H₅CH₂MgCl; FW: 150.89; liq.; f.p. 1°F (THF)
air sensitive, moisture sensitive
 Note: Free rubber septum included.

0.25mole
1mole

12-0500 **Bis(cyclopentadienyl)magnesium (99.9+%-Mg) (1284-72-6)**
 amp (C₅H₅)₂Mg; FW: 154.49; white to light-pink xtl.; m.p. 176°; b.p. 290° (subl.
 HAZ 160°/0.1mm)
air sensitive, moisture sensitive

1g
5g
25g

97-1040 **Bis(cyclopentadienyl)magnesium (99.99+%-Mg) PURATREM**
 amp (1284-72-6)
 HAZ (C₅H₅)₂Mg; FW: 154.49; white to light pink xtl.; m.p. 176°;
 b.p. 290° (subl. 160°/0.1mm)
air sensitive, moisture sensitive



1g
5g
25g

12-0845 **Bis(N,N'-di-sec-butylacetamidinato)magnesium, 99%**
 NEW C₂₀H₄₂MgN₄; FW: 362.88; colorless to pale yellow liq.
moisture sensitive
 Note: Product sold under, use subject to, terms and conditions of label license at www.strem.com/harvard2

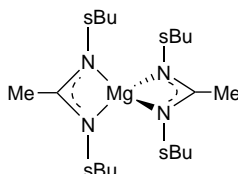

1g
5g

12-0510 **Bis(ethylcyclopentadienyl)magnesium, min. 98%**
 amp (114460-02-5)
 HAZ (C₂H₅C₅H₄)₂Mg; FW: 210.60; colorless to pale yellow liq.
air sensitive, moisture sensitive
 Note: Available prepacked in ALD cylinder- see 98-4006, 98-4010.
 For detailed technical note visit strem.com.

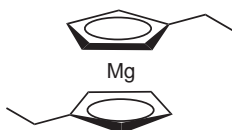

1g
5g
25g

MAGNESIUM (Compounds)

98-4006 HAZ	Bis(ethylcyclopentadienyl)magnesium, min. 98%, 12-0510, contained in 50 ml Swagelok® cylinder (96-1070) for CVD/ALD (114460-02-5) (C ₂ H ₅ C ₅ H ₄) ₂ Mg; FW: 210.60; colorless to pale yellow liq. <i>air sensitive, moisture sensitive</i> Note: High temperature Swagelok® cylinder assembly 96-1071 available at extra cost. See 98-4010. For detailed technical note visit strem.com .	10g
98-4010 HAZ	Bis(ethylcyclopentadienyl)magnesium, min. 98%, 12-0510, contained in high-temp 50 ml Swagelok® cylinder (96-1071) for CVD/ALD (114460-02-5) (C ₂ H ₅ C ₅ H ₄) ₂ Mg; FW: 210.60; colorless to pale yellow liq. <i>air sensitive, moisture sensitive</i> For detailed technical note visit strem.com .	10g 25g
12-1045 amp HAZ	Bis(pentamethylcyclopentadienyl)magnesium, min. 98% (74507-64-5) [(CH ₃) ₅ C ₅]Mg; white to yellow xtl. <i>air sensitive, moisture sensitive</i>	500mg 2g
97-1045 amp HAZ	Bis(pentamethylcyclopentadienyl)magnesium, elec. gr. (99.999%-Mg) PURA-TREM (74507-64-5) [(CH ₃) ₅ C ₅]Mg; FW: 294.77; white to yellow xtl. <i>air sensitive, moisture sensitive</i>	1g 5g 25g
12-0550 amp HAZ	Bis(n-propylcyclopentadienyl)magnesium, min. 98% (114504-74-4) (C ₃ H ₇ C ₅ H ₄) ₂ Mg; FW: 238.66; colorless to pale yellow liq.; d. 0.94 <i>air sensitive, moisture sensitive</i>	1g 5g
12-0900	Bis(2,2,6,6-tetramethyl-3,5-heptanedionato)magnesium, anhydrous, min. 98% [Mg(TMHD)₂] (21361-35-3) Mg(C ₁₁ H ₁₉ O ₂) ₂ ; FW: 390.85; white pwdr. <i>hygroscopic</i> Note: Available prepacked in ALD cylinder- see 98-4069.	1g 5g
98-4069	Bis(2,2,6,6-tetramethyl-3,5-heptanedionato)magnesium, anhydrous, min. 98% [Mg(TMHD)₂] , 12-0900, contained in high-temp 50 ml Swagelok® cylinder (96-1071) for CVD/ALD (21361-35-3) Mg(C ₁₁ H ₁₉ O ₂) ₂ ; FW: 390.85; white pwdr. <i>hygroscopic</i>	15g
12-1000	Bis(2,2,6,6-tetramethyl-3,5-heptanedionato)magnesium dihydrate, min. 98% [Mg(TMHD)₂] (625832-70-4) Mg(C ₁₁ H ₁₉ O ₂) ₂ ·2H ₂ O; FW: 390.85 (426.88); white pwdr.; m.p. 135-150°(-H ₂ O); b.p. dec. 290° (subl. 150°/0.05mm)	1g 5g 25g
93-1204 HAZ	n-Butylmagnesium chloride, 1.5-3.0 M in THF (693-04-9) C ₄ H ₉ MgCl; FW: 116.87; liq.; f.p. 1°F (THF) <i>air sensitive, moisture sensitive</i> Note: Free rubber septum included.	0.25mole 1mole
12-0803 HAZ	sec-Butylmagnesium chloride, lithium chloride complex 1.2M (15wt% ±1wt%) in tetrahydrofuran (15366-08-2) CH ₃ CH ₂ CH(CH ₃)MgCl·LiCl; FW: 159.26; dark brown liq. <i>air sensitive, moisture sensitive</i> Note: A product of Rockwood Lithium. Sold for R&D purposes only.	0.25mole 1mole
93-1212 HAZ	Ethylmagnesium bromide, 3M in ether (925-90-6) C ₂ H ₅ MgBr; FW: 133.28; liq. <i>air sensitive, moisture sensitive</i> Note: Free rubber septum included.	0.25mole 1mole
12-0810 HAZ	Ethylmagnesium bromide, 3.4M (40wt% ±1wt%) in 2-methyltetrahydrofuran (925-90-6) C ₂ H ₅ BrMg; FW: 133.28; dark brown liq. <i>air sensitive, moisture sensitive</i> Note: A product of Rockwood Lithium. Sold for R&D purposes only.	0.25mole 1mole
12-0800 HAZ	Ethylmagnesium chloride, 2M in ether (2386-64-3) C ₂ H ₅ MgCl; FW: 88.83; liq. <i>air sensitive, moisture sensitive</i> Note: Free rubber septum included.	0.2mole 1mole
93-1216	Magnesium acetate tetrahydrate, 99% (16674-78-5) Mg(OOCC ₂ H ₃) ₂ ·4H ₂ O; FW: 142.40 (214.46); white xtl.; m.p. 80°; d. 1.454	250g 1kg

MAGNESIUM (Compounds)

93-1280	Magnesium acetylacetonate, anhydrous, 98% (14024-56-7) Mg(CH ₃ C(O)CHC(O)CH ₃) ₂ ; FW: 222.53; white powdr.; m.p. dec.	25g 100g
12-1100 HAZ	Magnesium aluminum i-propoxide (99.99%-Mg) PURATREM (69207-83-6) MgAl ₂ (OC ₃ H ₇) ₆ ; FW: 550.97; white xtl.; m.p. 40°; b.p. 110°/5 mm <i>moisture sensitive</i>	10g 50g
12-0801 HAZ	Magnesium bis(di-i-propylamide) 0.7M (18wt% ±2wt%) in tetrahydrofuran (23293-23-4) {[(CH ₃) ₂ CH]N ₂ } ₂ Mg; FW: 224.67; liq. <i>air sensitive, moisture sensitive</i> Note: A product of Rockwood Lithium. Sold for R&D purposes only.	0.05mole 0.25mole
12-1200	Magnesium bis(trifluoromethylsulfonyl)imide, min. 97% (133395-16-1) Mg[(CF ₃ SO ₂) ₂ N] ₂ ; FW: 584.60; white powdr. <i>moisture sensitive</i> For detailed technical note visit strem.com .	1g 5g
93-1218	Magnesium bromide, anhydrous, 98% (7789-48-2) MgBr ₂ ; FW: 184.13; off-white powdr.; m.p. 700°; d. 3.72 <i>hygroscopic</i>	10g 50g
93-1219	Magnesium bromide hexahydrate, 98+% (13446-53-2) MgBr ₂ ·6H ₂ O; FW: 184.13 (292.22); white xtl.; m.p. 172°; d. 2.00	250g 1kg
93-1220	Magnesium carbonate, basic pentahydrate, 99% (39409-82-0) (MgCO ₃) ₄ ·Mg(OH) ₂ ·5H ₂ O; FW: 413.63 (485.69); white powdr.	100g 500g
93-1221	Magnesium chloride, 97.5% (H₂O - 2% max.) (7786-30-3) MgCl ₂ ; FW: 95.22; off-white powdr.; m.p. 714°; b.p. 1412°; d. 2.32 <i>hygroscopic</i>	250g 1kg
12-1250 HAZ	Magnesium ethoxide, 98% (2414-98-4) Mg(OC ₂ H ₅) ₂ ; FW: 114.44; white granular solid; m.p. dec. <i>moisture sensitive</i> Note: Sold in collaboration with Evonik for research purposes only.	100g 500g
12-1260 HAZ	Magnesium 2-ethylhexanoate, 30-40% solution in toluene (15602-15-0) Mg[OOCCH(C ₂ H ₅)C ₄ H ₉] ₂ ; FW: 310.72; viscous, amber liq.	50g 250g
93-1225	Magnesium fluoride, 99% (7783-40-6) MgF ₂ ; FW: 62.32; white powdr.; m.p. 1248°; b.p. 2239°; d. 3.0	500g 2kg
93-1226	Magnesium fluoride (99.99%-Mg) PURATREM (7783-40-6) MgF ₂ ; FW: 62.32; 1-4mm white pieces; m.p. 1248°; b.p. 2239°; d. 3.0	25g 100g
93-1227	Magnesium hexafluoroacetylacetonate dihydrate, min. 97% (120156-45-8) Mg(CF ₃ C(O)CHC(O)CF ₃) ₂ ·2H ₂ O; FW: 438.41 (474.44); white powdr.	1g 5g
93-1252 HAZ	Magnesium hexafluorosilicate hexahydrate, 98% (18972-56-0) MgSiF ₆ ·6H ₂ O; FW: 166.39 (274.48); white powdr.; d. 1.788	250g 1kg
93-1229	Magnesium hydroxide, 95% (1309-42-8) Mg(OH) ₂ ; FW: 58.33; white powdr.; d. 2.36	500g 2kg
93-1235	Magnesium molybdate (99.9%-Mo) (13767-03-8) MgMoO ₄ ; FW: 184.25; white powdr.; d. 2.208	10g 50g
93-1236	Magnesium naphthenate (3.5-8.0% Mg) (68424-71-5) dark viscous liq.	100g 500g
93-1238 HAZ	Magnesium nitrate hexahydrate, 99% (ACS) (13446-18-9) Mg(NO ₃) ₂ ·6H ₂ O; FW: 148.32 (256.41); white xtl.; m.p. 89°; d. 1.64 <i>hygroscopic</i>	250g 1kg
93-1237 HAZ	Magnesium nitrate hexahydrate (99.999%-Mg) PURATREM (13446-18-9) Mg(NO ₃) ₂ ·6H ₂ O; FW: 148.32 (256.41); white xtl.; m.p. 89°; d. 1.64 <i>hygroscopic</i>	25g 100g
12-2025	Magnesium oxide (99.99+%-Mg) PURATREM (1309-48-4) MgO; FW: 40.31; white powdr.; m.p. 2800°; b.p. 3600°; d. 3.58	5g 25g
93-1244	Magnesium oxide, -325 mesh, 98% (1309-48-4) MgO; FW: 40.31; white powdr.; m.p. 2800°; b.p. 3600°; d. 3.58	1kg
93-1243	Magnesium oxide, -325 mesh (99.5%-Mg) (1309-48-4) MgO; FW: 40.31; white powdr.; m.p. 2800°; b.p. 3600°; d. 3.58	100g 500g
93-1241	Magnesium oxide, -325 mesh (99.95%-Mg) (1309-48-4) MgO; FW: 40.31; white powdr.; m.p. 2800°; b.p. 3600°; d. 3.58	25g 100g

MAGNESIUM (Compounds)

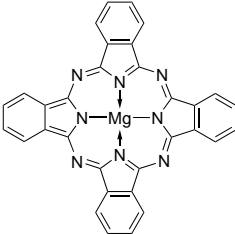
12-1405	Magnesium oxide nanopowder (1309-48-4) See page 161	
93-1246	Magnesium perchlorate, reagent (99.9%-Mg) (10034-81-8) HAZ Mg(ClO ₄) ₂ ; FW: 223.21; white powdr.; m.p. 251° dec.; d. 2.21 <i>hygroscopic</i>	50g 250g
93-1248	Magnesium perchlorate hexahydrate, 99% (13446-19-0) HAZ Mg(ClO ₄) ₆ ·6H ₂ O; FW: 223.21 (331.33); white xtl.; m.p. 185-190°; d. 1.98 <i>hygroscopic</i>	100g 500g
93-1250	Magnesium phthalocyanine, min. 90% (1661-03-6) (C ₃₂ H ₁₆ N ₈)Mg; FW: 536.83; purple powdr.	5g
		
93-1293	Magnesium silicide (99.5%-Mg) (C < 1%) (22831-39-6) HAZ Mg ₂ Si; FW: 76.71; -20 mesh gray powdr.; m.p. 1102°; d. 1.94 <i>moisture sensitive</i>	10g 50g
93-1255	Magnesium sulfate, anhydrous, 99+% (7487-88-9) MgSO ₄ ; FW: 120.39; white powdr.; m.p. 1124° dec.; d. 2.66 <i>hygroscopic</i>	250g 1kg
93-1256	Magnesium sulfate heptahydrate, 98+% (ACS) (10034-99-8) MgSO ₄ ·7H ₂ O; FW: 120.39 (246.48); white xtl.; d. 1.68	250g 1kg
12-1212	Magnesium (N,N,N',N'-tetramethylethylenediamine)bis[BREW] (99.99%-Mg) PURATREM Mg(C ₆ H ₁₆ N ₂)[C _x H _y C(O)CHC(O)C _x Hy] ₂ (x=3-4, y=2x+1); pale yellow liq. <i>moisture sensitive</i> Note: ***Limited quantities available. Will discontinue when stock gone***	1g 5g
Technical Note: 1. See 56-5656 (page 11)		
12-2000	Magnesium meso-tetraphenylporphine hydrate (14640-21-2) (C ₄₄ H ₂₈ N ₄)Mg·XH ₂ O; FW: 637.04; purple xtl.	1g 5g
93-1258	Magnesium titanate, tech. gr., (~85%) (12032-30-3) MgTiO ₃ ; FW: 120.21; white powdr.; m.p. 1610°; d. 3.36	100g 500g
93-1259	Magnesium trifluoroacetylacetonate dihydrate, min. 98% (53633-79-7) Mg(CF ₃ COCHCOCH ₃) ₂ ·2H ₂ O; FW: 330.47 (366.50); white powdr.	5g 25g
12-4000	Magnesium trifluoromethanesulfonate, min. 98% (Magnesium triflate) (60871-83-2) Mg(SO ₃ CF ₃) ₂ ; FW: 322.45; white powdr. <i>hygroscopic</i>	5g 25g
93-1261	Magnesium tungstate (99.9%-W) (13573-11-0) MgWO ₄ ; FW: 272.16; -325 mesh white powdr.	10g 50g
93-1265	Methylmagnesium bromide, 3M in ether (75-16-1) HAZ CH ₃ MgBr; FW: 119.26; liq. <i>air sensitive, moisture sensitive</i> Note: Free rubber septum included.	0.25mole 1mole
12-0815	Methylmagnesium bromide, 3.2M (35wt% ±1wt%) in 2-methyltetrahydrofuran (75-16-1) HAZ CH ₃ MgBr; FW: 119.26; brown liq. <i>air sensitive, moisture sensitive</i> Note: A product of Rockwood Lithium. Sold for R&D purposes only.	0.25mole 1mole
93-1266	Methylmagnesium chloride, 3M in THF (676-58-4) HAZ CH ₃ MgCl; FW: 74.81; liq.; f.p. 1°F (THF) <i>air sensitive, moisture sensitive</i> Note: Free rubber septum included.	0.25mole 1mole

MAGNESIUM (Compounds)

12-0820 HAZ	Phenylmagnesium bromide, 2.9M (45wt% ±1wt%) in 2-methyltetrahydrofuran (100-58-3) C ₆ H ₅ BrMg; FW: 136.88; liq. <i>air sensitive, moisture sensitive</i> Note: A product of Rockwood Lithium. Sold for R&D purposes only.	0.25mole 1mole
93-1268 HAZ	Phenylmagnesium bromide, 3M in ether (100-58-3) C ₆ H ₅ MgBr; FW: 181.34; liq. <i>air sensitive, moisture sensitive</i> Note: Free rubber septum included.	0.25mole 1mole
93-1269 HAZ	Phenylmagnesium chloride, 2-3M in THF (100-59-4) C ₆ H ₅ MgCl; FW: 136.88; liq.; f.p. 1°F (THF) <i>air sensitive, moisture sensitive</i> Note: Free rubber septum included.	0.25mole 1mole
12-0825 HAZ	i-Propylmagnesium bromide, 2.9M (35wt% ±1wt%) in 2-methyltetrahydrofuran (920-39-8) (CH ₃) ₂ CHMgBr; FW: 147.30; liq. <i>air sensitive, moisture sensitive</i> Note: A product of Rockwood Lithium. Sold for R&D purposes only.	0.25mole 1mole
93-1271 HAZ	i-Propylmagnesium chloride, 2-3M in ether (1068-55-9) (CH ₃) ₂ CHMgCl; FW: 102.85; liq. <i>air sensitive, moisture sensitive</i> Note: Free rubber septum included.	0.25mole 1mole
12-0827 HAZ	i-Propylmagnesium chloride, lithium chloride complex 1.3M (14wt% ±1wt%) in tetrahydrofuran (745038-86-2) (CH ₃) ₂ CHMgCl·LiCl; FW: 145.24; yellow-brown liq. <i>air sensitive, moisture sensitive</i> Note: A product of Rockwood Lithium. Sold for R&D purposes only.	0.25mole 1mole
12-0832 HAZ	2,2,6,6-Tetramethylpiperidylmagnesium chloride, lithium chloride complex 1.0M (18wt% ±2wt%) in toluene/tetrahydrofuran (215863-85-7) C ₉ H ₁₈ NMg(LiCl); FW: 200.00 (242.40); brown liq. <i>air sensitive, moisture sensitive</i> Note: A product of Rockwood Lithium. Sold for R&D purposes only.	0.05mole 0.25mole

MANGANESE (Elemental Forms)

25-0050 HAZ	Manganese chips (99.9%) (7439-96-5) Mn; FW: 54.93; brown, irregular pieces; m.p. 1260°; b.p. 1900°; d. 7.20	500g 2kg
25-0100 HAZ	Manganese powder (99+%) (7439-96-5) Mn; FW: 54.93; 20-50 mesh; m.p. 1260°; b.p. 1900°; d. 7.20	100g 500g
93-2543 HAZ	Manganese powder (99.5%) (7439-96-5) Mn; FW: 54.93; -325 mesh; m.p. 1260°; b.p. 1900°; d. 7.20	250g 1kg

MANGANESE (Compounds)

98-4060 HAZ	Bis(cyclopentadienyl)manganese, 98+%, 25-0200, contained in 50 ml Swagelok® cylinder (96-1070) for CVD/ALD (73138-26-8) (C ₅ H ₅) ₂ Mn; FW: 185.13; brown xtl.; m.p. 172-173° <i>air sensitive, moisture sensitive</i>	10g 25g
25-0200 amp HAZ	Bis(cyclopentadienyl)manganese, 98+% (Manganocene) (73138-26-8) (C ₅ H ₅) ₂ Mn; FW: 185.13; brown xtl.; m.p. 172-173° <i>air sensitive, moisture sensitive</i> Note: Available prepacked in ALD cylinder- see 98-4060.	1g 5g 25g
25-0230 amp	Bis(N,N'-di-i-propylpentylamidinato)manganese(II), min. 98% (1188406-04-3) C ₂₂ H ₄₆ MnN ₄ ; FW: 421.57; brown solid <i>air sensitive, moisture sensitive</i> Note: Product sold under, use subject to, terms and conditions of label license at www.strem.com/harvard2 For detailed technical note visit strem.com .	250mg 1g 5g

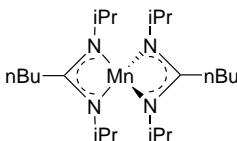

MANGANESE (Compounds)

25-0210 amp HAZ	Bis(ethylcyclopentadienyl)manganese, min. 98% (101923-26-6) [(C ₂ H ₅)C ₅ H ₄] ₂ Mn; FW: 241.23; dark red liq. <i>air sensitive, moisture sensitive</i> Note: Available prepacked in ALD cylinder- see 98-4065.	1g 5g 25g
98-4065 HAZ	Bis(ethylcyclopentadienyl)manganese, min. 98%, 25-0210, contained in 50 ml Swagelok® cylinder (96-1070) for CVD/ALD (101923-26-6) [(C ₂ H ₅)C ₅ H ₄] ₂ Mn; FW: 241.23; dark red liq. <i>air sensitive, moisture sensitive</i>	10g 25g
25-0235 amp	Bis(pentamethylcyclopentadienyl)manganese, min. 98% (Decamethylmanganocene) (67506-86-9) [(CH ₃) ₅ C ₅] ₂ Mn; FW: 325.38; orange xtl.; m.p. 292° <i>air sensitive, moisture sensitive</i>	1g 5g
25-0245 amp HAZ	Bis(i-propylcyclopentadienyl)manganese, min. 98% (85594-02-1) [(C ₃ H ₇)C ₅ H ₄] ₂ Mn; FW: 269.28; dark red liq. <i>air sensitive, moisture sensitive</i>	1g 5g
25-0265 amp HAZ	Bis(tetramethylcyclopentadienyl)manganese, min. 98% (101932-75-6) [(CH ₃) ₄ C ₅ H ₂] ₂ Mn; FW: 297.33; red xtl. <i>air sensitive, moisture sensitive</i>	1g 5g
25-2900	Carulite® Catalyst (185036-38-8) MnO ₂ /CuO; FW: 86.94/79.54; brown to black gran.; SA: 205m ² /g <i>hygroscopic</i>	250g 1kg
25-0300	(1R,2R)-(-)-[1,2-Cyclohexanediamino-N,N'-bis(3,5-di-t-butylsalicylidene)]manganese(III) chloride, 98% (R,R)-Jacobsen Cat. (138124-32-0) C ₃₆ H ₅₂ ClMnN ₂ O ₂ ; FW: 635.22; brown powdr.; m.p. 324-326° For detailed technical note visit strem.com .	1g 5g
25-0301	(1S,2S)-(+)-[1,2-Cyclohexanediamino-N,N'-bis(3,5-di-t-butylsalicylidene)]manganese(III) chloride, 98% (S,S)-Jacobsen Cat. (135620-04-1) C ₃₆ H ₅₂ ClMnN ₂ O ₂ ; FW: 635.22; brown powdr.; m.p. 325-326°	1g 5g
Technical Note: 1. See 25-0300 (page 125)		
25-0390 HAZ	Cyclopentadienylmanganese tricarbonyl, 98% Cymantrene (12079-65-1) C ₅ H ₅ Mn(CO) ₃ ; FW: 204.06; yellow xtl.; m.p. 77° <i>air sensitive</i>	1g 5g 25g
93-2502	Manganese(II) acetate tetrahydrate, 99+% (6156-78-1) Mn(OOCCCH ₃) ₂ ·4H ₂ O; FW: 173.02 (245.08); pink powdr.; d. 1.589	250g 1kg
25-0760	Manganese(II) acetate tetrahydrate (99.99%-Mn) PURATREM (6156-78-1) Mn(CH ₃ COO) ₂ ·4H ₂ O; FW: 173.02 (245.08); pale pink xtl.; d. 1.589	5g 25g
25-0750	Manganese(III) acetate dihydrate, 98% (19513-05-4) Mn(OOCCCH ₃) ₃ ·2H ₂ O; FW: 232.08 (268.10); brown xtl.	5g 25g
93-2503	Manganese(II) acetylacetonate, 95% (14024-58-9) Mn(CH ₃ C(O)CHC(O)CH ₃) ₂ ; FW: 253.14; tan powdr.; m.p. > 180° <i>hygroscopic</i>	50g 250g
25-1000	Manganese(III) acetylacetonate, min. 90% (14284-89-0) Mn(CH ₃ C(O)CHC(O)CH ₃) ₃ ; FW: 352.27; black xtl.; m.p. 172° <i>hygroscopic</i>	25g 100g
93-2506	Manganese(II) bromide, anhydrous, min. 97% (99.9%-Mn) (13446-03-2) MnBr ₂ ; FW: 214.76; pink powdr.; m.p. dec.; d. 4.385 <i>hygroscopic</i>	10g 50g
25-1250 NEW	Manganese(II) bromide, bis(tetrahydrofuran), min. 98% (57298-42-7) MnBr ₂ (C ₄ H ₈ O) ₂ ; FW: 358.96; light pink-orange powdr. <i>moisture sensitive</i>	1g 5g 25g
93-2507	Manganese(II) bromide tetrahydrate, 98% (10031-20-6) MnBr ₂ ·4H ₂ O; FW: 214.76 (286.82); pink xtl.; m.p. 64.3° dec. <i>hygroscopic</i>	25g 100g
93-2533	Manganese(II) carbonate, min. 90% (598-62-9) MnCO ₃ ; FW: 114.95; light brown powdr.; m.p. 350° dec.; d. 3.125	100g 500g

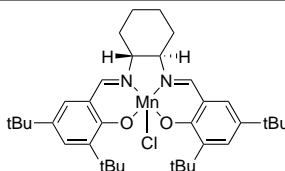

MANGANESE (Compounds)

25-1330	Manganese carbonyl, 98% (10170-69-1) Mn ₂ (CO) ₁₀ ; FW: 389.99; yellow xtl.; m.p. 152-155° <i>air sensitive, (store cold)</i>	2g 10g 50g
93-2527	Manganese(II) chloride, anhydrous, 97% (7773-01-5) MnCl ₂ ; FW: 125.84; pink flakes; m.p. 650°; b.p. 1190°; d. 2.98 <i>hygroscopic</i>	500g 2kg
25-1345	Manganese(II) chloride anhydrous (99.995%-Mn) PURATREM (7773-01-5) MnCl ₂ ; FW: 125.84; pink solid; m.p. 650°; b.p. 1190°; d. 2.98 <i>hygroscopic</i>	5g 25g 100g
93-2534	Manganese(II) chloride tetrahydrate, 98+% (ACS) (13446-34-9) MnCl ₂ ·4H ₂ O; FW: 125.84 (197.91); rose xtl.; m.p. 58°; d. 2.01 <i>hygroscopic</i>	250g 1kg
25-1355	Manganese(II) chloride tetrahydrate (99.995%-Mn) PURATREM (13446-34-9) MnCl ₂ ·4H ₂ O; FW: 125.84 (197.91); rose xtl.; m.p. 58°; d. 2.01	5g 25g
93-2508	Manganese(II) cyclohexanebutyrate (35542-88-2) Mn[OOC(CH ₂) ₃ C ₆ H ₁₁] ₂ ; FW: 393.43; off-white powdr.	1g 5g
25-1200	Manganese(II) ethyl/butyl phosphonate Silica (PhosphonicS POMn) white solid; SA: >350 m ² /g Note: Sold in collaboration with PhosphonicS Ltd. for research purposes only. PhosphonicS Metal Oxidation Catalyst Kit component.	5g 25g

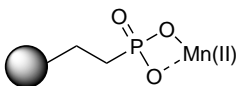

Particle size range: 70-200 microns

Average pore size: 60Å

Effective loadings: 0.3 to 0.5 mmol/g

93-2532	Manganese(II) 2-ethylhexanoate, 40% solution in mineral spirits (6% Mn) (13434-24-7) Mn[OOCCH(C ₂ H ₅)C ₄ H ₉] ₂ ; FW: 341.35; dark liq.	250g 1kg
93-2509	Manganese(II) fluoride, 99% (7782-64-1) MnF ₂ ; FW: 92.93; light brown powdr.; m.p. 856°; d. 3.98 <i>hygroscopic</i>	5g 25g
93-2542	Manganese(III) fluoride, 98% (7783-53-1) MnF ₃ ; FW: 111.93; red powdr.; m.p. dec.; d. 3.54 <i>hygroscopic</i>	5g 25g
93-2512	Manganese(II) iodide, anhydrous, 98+% (7790-33-2) MnI ₂ ; FW: 308.75; reddish-brown powdr. <i>hygroscopic</i>	10g 50g
93-2514	Manganese(II) molybdate (99.9%-Mo) (14013-15-1) MnMoO ₄ ; FW: 214.88; orange-brown solid	5g 25g
93-2516	Manganese naphthenate, 56% in mineral spirits (6% Mn) (1336-93-2) viscous liq.; f.p. 104°F	100g 500g
93-2517	Manganese(II) nitrate, 50-52% aqueous solution (10377-66-9) Mn(NO ₃) ₂ ; FW: 178.95; pink liq.	250g 1kg
93-2513	Manganese(II,III) oxide, 97% (1317-35-7) Mn ₃ O ₄ ; FW: 228.79; brown powdr.; m.p. 1705°; d. 4.856	250g 1kg
93-2515	Manganese(II) oxide, 99% (1344-43-0) MnO; FW: 70.94; green powdr.; d. 5.43-5.46	500g 2kg
93-2522	Manganese(III) oxide, 99% (1317-34-6) Mn ₂ O ₃ ; FW: 157.86; black powdr.; m.p. 1080° dec.; d. 4.50	250g 1kg
93-2510	Manganese(IV) oxide, 99+% (1313-13-9) MnO ₂ ; FW: 86.94; black xtl.; m.p. 535° dec.; d. 5.026	100g 500g
25-1380	Manganese(IV) oxide (99.995%-Mn) PURATREM (1313-13-9) MnO ₂ ; FW: 86.94; black, random pieces; m.p. 535° dec.; d. 5.026	10g 50g
25-1360	Manganese(IV) oxide, activated (1313-13-9) MnO ₂ ; FW: 86.94; brown to black powdr.; m.p. 535° dec.; d. 5.026	50g 250g
25-1450	Manganese pentacarbonyl bromide, min. 98% (14516-54-2) Mn(CO) ₅ Br; FW: 274.90; yellow to orange xtl.	1g 5g 25g

MANGANESE (Compounds)

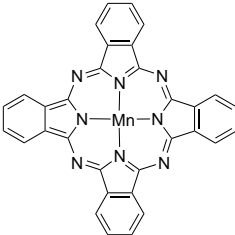
93-2520 HAZ	Manganese(II) perchlorate hexahydrate, 99% (15364-94-0) Mn(ClO ₄) ₂ ·6H ₂ O; FW: 253.84 (361.93); pink xtl. <i>hygroscopic</i>	100g 500g
25-1460	Manganese(II) phthalocyanine, min. 97% (14325-24-7) (C ₃₂ H ₁₆ N ₈)Mn; FW: 567.47; purple xtl.	1g 5g
		
93-2521	Manganese(II) selenide (99.9%-Mn) (1313-22-0) MnSe; FW: 133.90; -20 mesh black xtl.	5g 25g
93-2524	Manganese(II) sulfide (99.9%-Mn) (18820-29-6) MnS; FW: 87.00; -325 mesh green powdr.; m.p. dec.; d. 3.99	5g 25g
25-1470	Manganese(III) meso-tetraphenylporphine acetate (58356-65-3) Mn(C ₄₄ H ₂₈ N ₄)OOCCH ₃ ; FW: 726.71; greenish black powdr.	1g 5g
25-1550 HAZ	Methylcyclopentadienylmanganese tricarbonyl, min. 97% (12108-13-3) (CH ₅ C ₅ H ₄)Mn(CO) ₃ ; FW: 218.09; yellow liq.; m.p. -2.2°; b.p. 233°; f.p. 205°F; d. 1.38	5g 25g
96-6770	PhosphonicS Metal Oxidation Catalyst Kit See page 488	
25-5000	Tris(2,2,6,6-tetramethyl-3,5-heptanedionato)manganese(III), 99% [Mn(TMHD)₃] (14324-99-3) Mn(C ₁₁ H ₁₉ O ₂) ₃ ; FW: 604.74; black xtl.; m.p. 165°; b.p. dec. 255°	1g 5g 25g

MERCURY (Elemental Forms)

93-8046 HAZ	Mercury (99.9994%) (ACS) (7439-97-6) Hg; m.p. -38.89°; b.p. 356.9°; d. 200.61 13.546	450g 2.25kg
93-8045 HAZ	Mercury, redistilled (99.998%) (7439-97-6) Hg; FW: 200.61; m.p. -38.89°; b.p. 356.9°; d. 13.546	450g 2.25kg

MERCURY (Compounds)

93-8040 HAZ	Mercury(II) acetate, 98% (1600-27-7) Hg(OOCCH ₃) ₂ ; FW: 318.68; white to light yellow powdr.; m.p. dec.; d. 3.270	25g 100g
93-8003 HAZ	Mercury(II) bromide (ACS) (7789-47-1) HgBr ₂ ; FW: 360.44; white powdr.; m.p. 236°; b.p. 322°; d. 6.109	50g 250g
93-8018 HAZ	Mercury(I) chloride, 99.5+% (ACS) (10112-91-1) Hg ₂ Cl ₂ ; FW: 472.09; -100 mesh white powdr.; m.p. 400° subl.; d. 7.150	100g 500g
93-8004 HAZ	Mercury(II) chloride, 99+% (7487-94-7) HgCl ₂ ; FW: 271.50; white powdr.; m.p. 276°; b.p. 302°; d. 5.44	50g 250g
93-8041 HAZ	Mercury(II) cyanide, 99% (592-04-1) Hg(CN) ₂ ; FW: 252.65; white powdr.; m.p. dec.; d. 3.996	50g 250g
93-8019 HAZ	Mercury(I) fluoride, 95+% (13967-25-4) Hg ₂ F ₂ ; FW: 439.22; white powdr.; m.p. 570°; d. 8.73	5g
93-8007 HAZ	Mercury(II) fluoride, 98% (7783-39-3) HgF ₂ ; FW: 238.61; off-white to yellow powdr.; m.p. 645° dec.; d. 8.95	5g 25g
93-8008 HAZ	Mercury(II) iodide, 99+% (ACS) (7774-29-0) HgI ₂ ; FW: 454.45; orange to red powdr.; m.p. 259°; b.p. 354°; d. 6.271	50g 250g
80-8008 amp HAZ	Mercury(II) iodide, anhydrous (99.999%-Hg) PURATREM (7774-29-0) HgI ₂ ; FW: 454.45; orange to red powdr.; m.p. 259°; b.p. 354°; d. 6.271	5g 25g
93-8020 HAZ	Mercury(I) nitrate hydrate, 98+% (7782-86-7) HgNO ₃ ·H ₂ O; FW: 262.62 (280.63); yellow xtl.; m.p. 70°; d. 4.79	50g 250g
93-8009 HAZ	Mercury(II) nitrate monohydrate, 98+% (ACS) (7783-34-8) Hg(NO ₃) ₂ ·H ₂ O; FW: 324.60 (342.62); white xtl.; d. 4.3	50g 250g

MERCURY (Compounds)

93-8011 HAZ	Mercury(II) oxide, red, 99+% (ACS) (21908-53-2) HgO; FW: 216.59; red powdr.; m.p. 500° dec.; d. 11.14	50g 250g
93-8010 HAZ	Mercury(II) oxide, yellow, 99+% (ACS) (21908-53-2) HgO; FW: 216.59; yellow to orange powdr.; m.p. 500° dec.; d. 11.14	50g 250g
93-8042 HAZ	Mercury(II) perchlorate trihydrate, 99+% (73491-34-6) Hg(ClO ₄) ₂ ·3H ₂ O; FW: 399.46 (453.51); white xtl.; d. ~4 <i>hygroscopic</i>	10g 50g
93-8013 HAZ	Mercury(II) selenide (99.99%-Hg) PURATREM (20601-83-6) HgSe; FW: 279.55; gray powdr.	1g 5g 25g
93-8036 HAZ	Mercury(II) sulfate, min. 98% (7783-35-9) HgSO ₄ ; FW: 296.67; white powdr.; m.p. dec.; d. 6.47 <i>hygroscopic</i>	50g 250g
80-2200 HAZ	Mercury(II) trifluoromethanesulfonate, 98% (Mercury triflate) (49540-00-3) Hg(CF ₃ SO ₃) ₂ ; FW: 498.71; white powdr. <i>hygroscopic</i>	5g 25g
80-2300 HAZ	Methylmercury(II) hydroxide, ~1M aqueous solution (1184-57-2) CH ₃ HgOH; FW: 232.63; colorless liq.	0.001mole 0.01mole
93-8024 HAZ	Methylmercury(II) iodide, 98+% (143-36-2) CH ₃ HgI; FW: 342.56; yellow powdr.; m.p. 143°	5g 25g
93-8025 HAZ	Phenylmercury acetate, 97.5% (62-38-4) C ₆ H ₅ HgO(O)CCH ₃ ; FW: 336.75; white powdr.; m.p. 150°; d. ~2.4	50g 250g
80-7000 HAZ	Tetrakis(acetoxymercuri)methane, min. 95% (25201-30-3) C(HgOOCCH ₃) ₄ ; FW: 1050.55; white xtl.; m.p. 255-275° dec.	1g 5g

METALS SCAVENGING AGENTS (Compounds)

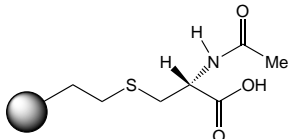
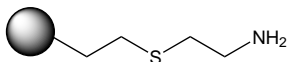
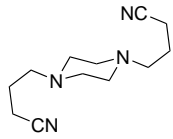
16-0200	N-Acetyl-L-cysteine ethyl Silica (PhosphonicS SCYT1) (7631-86-9) white to off-white solid Note: Sold in collaboration with PhosphonicS Ltd. for research purposes only. PhosphonicS Metals Scavenging Kit component and applications.		10g 50g
Silica size: 60-200 microns Pore size: 60Å Loading: 0.8 mmol/g Scavenges: Ru(III), Rh(I), Rh(III), Pd(0), Pd(II), Pt(II)			
16-0215	2-Aminoethyl sulfide ethyl Silica (PhosphonicS SEA) white to pale yellow solid Note: Sold in collaboration with PhosphonicS Ltd. for research purposes only. PhosphonicS Metals Scavenging Kit component and applications.		10g 50g
Silica size: 60-200 microns Pore size: 60Å Loading: 0.8 mmol/g Scavenges: Fe(III), Ni(II), Ni(III), Cu(II), Ru(III), Rh(I), Rh(III), Pd(0), Pd(II), Ag(I), Cd(II), Sn(II), Sn(IV), Pt(II), Hg(II), Pb(II)			
96-6700	BASF Metals Scavenging Agent Kit (MSA Kit) See page 531		
07-2203 NEW	1,4-Bis(2-isocyanopropyl)piperazine (SnatchCat Metal Scavenger) (51641-96-4) C ₁₂ H ₂₀ N ₄ ; FW: 220.31; white xtl. (store cold) Note: Sold in collaboration with Apeiron Synthesis, Inc. U.S. Patent 14/443,048; PCT/IB2014/062564. For detailed technical note visit strem.com .		1g 5g

METALS SCAVENGING AGENTS (Compounds)

06-1522	Chelating/scavenger resin with aminophosphonic - S940	50g 5x50g
NEW	spherical beads (wet) (store cold) Note: Store in dry conditions (2-20°C). Do not freeze. Shelf Life: 5 years; Particle Size: 425-850 micron; Purolite S940 is a chelating resin of macroporous structure, with a polystyrene matrix crosslinked with divinylbenzene (DVB) substituted with weakly acidic aminophosphonic active groups. This chemical structure facilitates the formation of complexes with metallic ions. The aminophosphonic chelating resins have a greater affinity for certain cations, and form more stable complexes with cations of low atomic mass metals than their iminodiacetic resin counterparts. Hence Purolite S940 is capable of fixing one or more specific cations from a larger range even from solutions which are highly concentrated. Sold in collaboration with Purolite for research purposes only.	
06-1525	Chelating/scavenger resin with aminophosphonic - S950	50g 5x50g
NEW	spherical beads (wet) (store cold) Note: Store in dry conditions (2-20°C). Do not freeze. Shelf Life: 5 years; Particle Size: 300-1000 micron; Purolite S950 is a macroporous aminophosphonic acid chelating resin, designed for the removal of cations of toxic metals such as lead, copper and zinc from industrial effluents at low pH. At somewhat higher pH values, calcium, magnesium and barium, as well as the toxic metals cadmium, nickel, and cobalt are strongly complexed and may be separated from quite high concentrations of univalent cations. Purolite S950 is highly selective (under the appropriate conditions) for a range of both heavy metal and common divalent ions. Hence its use may be recommended where it is necessary to remove calcium or magnesium in order to avoid possible precipitation, or where its selectivity for a particular range of metals offers advantages. Sold in collaboration with Purolite for research purposes only.	
06-1508	Chelating/scavenger resin with aminoxime - S910	50g 5x50g
NEW	spherical beads (wet) (store cold) Note: Store in dry conditions (2-20°C). Do not freeze. Shelf Life: 5 years; Particle Size: 300-1200 micron; Purolite® S910 is an amidoxime chelating resin, designed for the removal of cations of metals such as copper and iron from water or other solvent even at relatively low pH. It can also be used for the recovery of traces of precious metals from dilute solutions. It cannot be used for removal of alkaline earth metals. Sold in collaboration with Purolite for research purposes only.	
06-1530	Chelating/scavenger resin with bispicolylamine - S960	50g 5x50g
NEW	spherical beads (wet) (store cold) Note: Store in dry conditions (2-20°C). Do not freeze. Shelf Life: 5 years; Particle Size: 425-1000 micron; Purolite® S960 is a macroporous poly-styrene divinylbenzene copolymer within which weakly basic bis-picolylamine chelating functional groups are covalently bonded. This resin has high selectivity for valuable metals such as nickel, copper, and cobalt as compared to iron, aluminum, calcium, and magnesium. Purolite® S960 is active within the pH range of 0-8 and may function outside that range depending on the metals involved. Sold in collaboration with Purolite for research purposes only.	

METALS SCAVENGING AGENTS (Compounds)

06-1520	Chelating/scavenger resin with iminodiacetic - S930Plus	50g
NEW	spherical beads (wet)	5x50g
	<i>(store cold)</i>	
	<p>Note: Store in dry conditions (2-20°C). Do not freeze. Shelf Life: 5 years; Particle Size: 425-1000 micron; Purolite S930Plus is a macroporous polystyrene; based chelating resin, with iminodiacetic groups designed for the removal of heavy metals from industrial effluents. Purolite S930Plus finds use in processes for extraction and recovery of metals from ores, galvanic plating solutions, pickling baths and effluents. Further uses include the decalcification of brine for chloralkali processes, where Purolite S930Plus shows advantages under certain operating conditions over the typically used aminophosphonic type resins such as Purolite S940. Purolite S930Plus has high selectivity and capacity for hardness and strontium and has excellent osmotic stability. Purolite S930Plus is susceptible to oxidation. Hence direct treatment of brine solutions containing free chlorine should be avoided, for instance by preliminary reaction with sulphur dioxide, sulphide or, by use of a treatment with activated carbon. Brine solutions can often contain significant concentrations of chlorates. In this case it is necessary to ensure that the displacement rinse prior to the acid regeneration is efficient, so as to avoid the formation of free chlorine from contact of chlorates in the brine solution with the regeneration acid. Sold in collaboration with Purolite for research purposes only.</p>	
06-1514	Chelating/scavenger resin with isothiuronium - S920Plus	50g
NEW	spherical beads (wet)	5x50g
	<i>(store cold)</i>	
	<p>Note: Store in dry conditions (2-20°C). Do not freeze. Shelf Life: 5 years; Particle Size: 300-1200 micron; Purolite® S920Plus is a macroporous polystyrenic based chelating resin, with thiuronium groups designed for the selective removal of mercury and for the recovery of precious metals from industrial effluents. Mercury is strongly bound to the functional groups to form highly stable complexes, with high selective affinity compared with those of other heavy metals. These properties are largely unaffected by high chloride (or sulfate) content of the effluent. Effluent solutions which may typically contain 2 - 20 ppm of mercury can be treated to reduce the concentration in solution to less than 0.005 ppm. Purolite S920Plus can load up to 200g of mercury, or gold, or approximately 60g of platinum or palladium for each liter of resin, equivalent to 12.5, and 3.75 lb/ft³ respectively. Purolite S920Plus is designed for the removal of low concentrations of soluble mercury salts from waste streams and for the recovery of precious metals from rinse waters in the galvanic and electronic industries. It is also used in hydrometallurgy for the separation of precious metals from acid liquors. Mercury and precious metals are so strongly held, and run lengths are so long (thousands of hours) that it is not normally considered economic to regenerate the resin for reuse. Purolite S920Plus is more resistant to oxidation than many thiol based resins and contact with the atmosphere is not detrimental, however free chlorine and other strong oxidizing agents may damage the resin and their removal from solution by filtering through activated carbon is recommended. Sold in collaboration with Purolite for research purposes only.</p>	
06-1501	Chelating/scavenger resin with N-methylglucamine - S108	50g
NEW	spherical beads (wet)	5x50g
	<i>(store cold)</i>	
	<p>Note: Store in dry conditions (2-20°C). Do not freeze. Shelf Life: 5 years; Particle Size: 425-630 micron; Purolite® S108 is a macroporous polystyrenic based resin with excellent kinetics and functional groups specially designed for the selective removal of salts of boron from aqueous solutions. It is effective for such solutions over a wide range of pH values, and over a wide range of boron concentrations. The presence of boron ions in water for potable and agriculture/horticulture use, even in relatively small (ppm) concentrations can give rise to major problems. Even where concentrations of other ions are reasonably high, Purolite® S108 will reduce boron concentrations by an order of magnitude. Sold in collaboration with Purolite for research purposes only.</p>	

METALS SCAVENGING AGENTS (Compounds)

06-1528	Chelating/scavenger resin with phosphonic and sulfonic acid - S957 spherical beads (wet)	50g 5x50g
NEW	<i>(store cold)</i> Note: Store in dry conditions (2-20°C). Do not freeze. Shelf Life: 5 years; Particle Size: 425-1000 micron; Purolite S957 is a specially developed Monophos chelating resin, which incorporates phosphonic, and sulfonic functional groups on a mechanically and osmotically resistant matrix. These combined properties give it high selectivity for iron and other transitional metals, even in acidic solutions. Purolite S957 has been especially designed for the selective removal of ferric iron from acidic solutions, such as copper electrolyte or from nickel, cobalt and zinc processing solutions. Purolite S957 can also be used in potable water applications for the selective removal of trace levels of selected metals from neutral pH waters. Its selectivity for uranium and other lanthanide elements should give good opportunities for its successful employment in other areas. Sold in collaboration with Purolite for research purposes only.	
06-1532	Chelating/scavenger resin with polyamine - S985 spherical beads (wet)	50g 5x50g
NEW	<i>(store cold)</i> Note: Store in dry conditions (2-20°C). Do not freeze. Shelf Life: 5 years; Particle Size: 300-1200 micron; Purolite® S985 is a high capacity, macroporous, weak base anion exchange resin with a polyacrylic matrix supporting functional groups of the polyamine type. The carefully formulated, macroporous acrylic matrix ensures excellent exchange kinetics for the removal of trace heavy metals from waste water streams and the special polyamine functionality produces very interesting operating capacities and makes the uptake of metallic cations possible even when they are present in the waste stream as organic anionic complexes. Its tough and resilient macroporous structure also affords excellent mechanical, strength and resistance to osmotic shock. Sold in collaboration with Purolite for research purposes only.	
06-1518	Chelating/scavenger resin with thiol - S924 spherical beads (wet)	50g 5x50g
NEW	<i>(store cold)</i> Note: Store in dry conditions (2-20°C). Do not freeze. Shelf Life: 5 years; Particle Size: 300-1000 micron; Purolite S924 is a chelating resin, polystyrene based and designed for the selective removal of mercury. The mercury is strongly bound to the functional groups to form highly stable complexes with high selective affinity compared with those of other heavy metals. Even so the high selectivity for metals such as silver, copper, lead, cadmium, nickel and cobalt, makes this resin useful in waste treatment and hydrometallurgical processes. The high selectivity for mercury is largely unaffected by high chloride or sulphate content of the effluent. Effluent solutions that may typically contain 0.01-25ppm of mercury can be treated to reduce the concentration to significantly less than 5ppb residual mercury. Purolite S924 can load up to 150 g (16 lb/cu.ft) of mercury per litre of resin. Purolite S924 is designed for the removal of moderately low concentrations of soluble mercury salts from brine streams used to produce caustic soda and chlorine where mercury cells are used, and may be regenerated with concentrated hydrochloric acid solutions. In the process for the manufacture of caustic soda and chlorine from brine, where all or part of the production uses mercury cells, the mercury rich regenerant acid may be neutralized with the sodium hydroxide to produce a recovered brine solution that may be recycled to the mercury cell process. Mercury may be present at very low concentrations and consequently run lengths are often long (thousands of hours). It is sometimes not economic to regenerate the resin for re-use. In such cases Purolite S920 may be preferred because of its higher capacity. Purolite S924 is prone to oxidation and long-term contact with the atmosphere is detrimental. It is recommended that this resin is shipped and stored under water. Also, free chlorine and other strong oxidizing agents may damage the resin. Their removal from solution by filtering through activated carbon is recommended. Sold in collaboration with Purolite for research purposes only.	

METALS SCAVENGING AGENTS (Compounds)

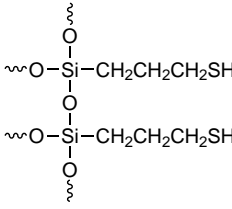
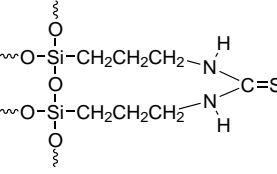
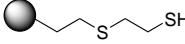
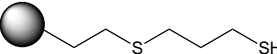
06-1512 NEW	Chelating/scavenger resin with thiourea - S914 spherical beads (wet) (store cold)	50g 5x50g
<p>Note: Store in dry conditions (2-20°C). Do not freeze. Shelf Life: 5 years; Particle Size: 300-1200 micron; Purolite S914 is a macroporous type chelating resin with thiourea functionality. It has very high selectivity for mercury and platinum group metals such as platinum, gold and silver. Purolite S914 is stable over the whole pH range. The applications include mercury removal from brine and effluent in chloralkali process, mercury removal from flue gas scrubber effluent, recovery of platinum group metals from effluents amongst others. Sold in collaboration with Purolite for research purposes only.</p>		
14-1871	Deloxan® MP Metal Scavengers (Thio-Functionalized Polysiloxane) Abrasion-proof spheres; Water content: 50-70%; SA: 300-450m ² /g (BET); P.Vol. 2.5-3.5 ml/g; d. 0.55-0.65 kg/L (wet form) Note: Sold in collaboration with Evonik for research purposes only. *Limited quantities available*	10g 50g 250g
		
Technical Note:		
<p>1. Deloxan® MP is a metal absorbing resin with a high affinity for precious and heavy metals, especially Pd, Pt, Rh, Ag, Au, Zn, Cu(I), Cd, Hg and Pb. The resin can absorb very low concentrations of metal ions from either aqueous or organic solutions, even in the presence of complexing agents such as phosphines, amines and nitriles. The particle size and morphology allow for easy handling and filtration.</p>		
References:		
<p>1. <i>Extraction and Ion Exchange</i>, 1991, 9, 2, 289</p>		
14-1870	Deloxan® THP II Macroporous, Thiourea-Functionalized Polysiloxane(Metal Absorbing Resin) Abrasion-proof spheres; Water content: 50-70%; SA: 300-450m ² /g (BET); P.Vol. 2.5-3.5 ml/g; d. 0.55-0.65 kg/L (wet form) Note: Sold in collaboration with Evonik for research purposes only. *Limited quantities available* For detailed technical note visit strem.com.	10g 50g 250g
		
16-0650	2-Mercaptoethyl ethyl sulfide Silica (PhosphonicS SEM26) (7631-86-9) white solid Note: Sold in collaboration with PhosphonicS Ltd. for research purposes only. PhosphonicS Metals Scavenging Kit component and applications.	10g 50g
		
Silica size: 60-200 microns Pore size: 60Å Loading: 0.8 mmol/g Scavenges: Fe(III), Ni(0), Cu(II), Ru(III), Rh(I), Rh(III), Pd(0), Pd(II), Ag(I), Pt(II), Hg(II)		
16-1700	3-Mercaptopropyl ethyl sulfide Silica (60+, high-cross linking) (PhosphonicS SPM36) (7631-86-9) white solid Note: Sold in collaboration with PhosphonicS Ltd. for research purposes only. PhosphonicS Metals Scavenging Kit component and applications.	10g 50g
		
Silica size: 60-200 microns Pore size: 60Å Loading: 0.8 mmol/g Scavenges: Fe(III), Ni(II), Cu(II), Ru(III), Rh(I), Rh(III), Pd(0), Pd(II), Ag(I), Cd(II), Sn(II), Sn(IV), Pt(II), Au, Hg(II), Pb(II)		

METALS SCAVENGING AGENTS (Compounds)

16-1706	3-Mercaptopropyl ethyl sulfide Silica (60+, low-cross linking) (PhosphonicS SPM32) white to pale yellow solid Note: Sold in collaboration with PhosphonicS Ltd. for research purposes only. PhosphonicS Metals Scavenging Kit component and applications.		10g 50g
Silica size: 60-200 microns Pore size: 60Å Loading: 0.8 mmol/g Scavenges: Fe(III), Ni(0), Ni(II), Cu(II), Ru(III), Rh(I), Rh(III), Pd(0), Pd(II), Ag(I), Cd(II), Sn(II), Sn(IV), Pt(II), Au, Hg(II), Pb(II)			
16-1702	3-Mercaptopropyl ethyl sulfide Silica (90+, high-cross linking) (PhosphonicS SPM36f) white to pale yellow solid Note: Sold in collaboration with PhosphonicS Ltd. for research purposes only. PhosphonicS Metals Scavenging Kit component and applications.		10g 50g
Silica size: 60-200 microns Pore size: 90Å Loading: 0.8 mmol/g Scavenges: Fe(III), Ni(II), Cu(II), Ru(III), Rh(I), Rh(III), Pd(0), Pd(II), Ag(I), Cd(II), Sn(II), Sn(IV), Pt(II), Hg(II), Pb(II)			
16-1704	3-Mercaptopropyl ethyl sulfide Silica (90+, low-cross linking) (PhosphonicS SPM32f) white to pale yellow solid Note: Sold in collaboration with PhosphonicS Ltd. for research purposes only. PhosphonicS Metals Scavenging Kit component and applications.		10g 50g
Silica size: 60-200 microns Pore size: 90Å Loading: 0.8 mmol/g Scavenges: Fe(III), Ni(0), Ni(II), Cu(II), Ru(III), Rh(I), Rh(III), Pd(0), Pd(II), Ag(I), Cd(II), Sn(II), Sn(IV), Pt(II), Au, Hg(II), Pb(II)			
14-4353	Metals scavenging agent, Mercaptopropyl modified silica (BASF MSA-FC Si-3) (112926-00-8) d50=83µm; white to slightly yellow powder; d. 0.88g/ml Note: Sold in collaboration with BASF for research purposes only. BASF Metals Scavenging Agent Kit component.		10g 50g
Technical Note: 1. Silica-based, air-stable, metal scavenging agent (MSA-FC Si-3) powder suitable for the removal of dissolved metal species from organic and aqueous polar and apolar reaction mixtures. Can be used in slurry and fixed bed type applications. Temperature stable up to 110°C. Especially suitable for use in the removal of palladium remains. Metal loading capacity is up to 13% depending on metal and process conditions. Metals scavenged: Pd [examples – H ₂ PdCl ₄]			
06-0805	Metals scavenging agent, Phosphotungstic acid modified activated carbon (BASF MSA-FC C-1) (7440-44-0) d50=27µm; black powder; d. 0.60g/ml Note: Sold in collaboration with BASF for research purposes only. BASF Metals Scavenging Agent Kit component.		10g 50g
Technical Note: 1. Carbon-based, air-stable, metal scavenging agent (MSA-FC C-1) powder suitable for the removal of dissolved metal species from organic polar and apolar reaction mixtures. Can be used in slurry and fixed bed type applications. Temperature stable up to 110°C. The presence of water and small chain alcohols may impact the total uptake capacity. Metal loading capacity up to 5 wt% depending on metal and process conditions. Metals scavenged: Pd, Rh [examples - Pd(PPh ₃) ₂ (OAc) ₂ , Ru(DUPHOS)(COD)BF ₄ , Rh(PPh ₃) ₃ Cl]			
13-6300	Metals scavenging agent, Phosphotungstic acid modified alumina (BASF MSA-FC Al-1) (1344-28-1) d50=159µm; white powder; d. 1.00 g/ml Note: Sold in collaboration with BASF for research purposes only. BASF Metals Scavenging Agent Kit component. For detailed technical note visit strem.com .		10g 50g

METALS SCAVENGING AGENTS (Compounds)

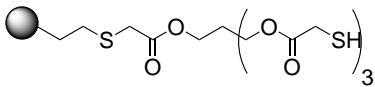
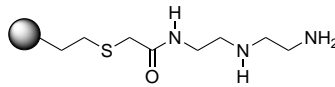
16-1540	Pentaerythritol 2-mercaptoacetate ethyl sulfide Silica (PhosphonicS SET) white solid Note: Sold in collaboration with PhosphonicS Ltd. for research purposes only. PhosphonicS Metals Scavenging Kit component and applications.		10g 50g
96-6750	PhosphonicS Metals Scavenging Kit See page 531		
16-0210	Triamine ethyl sulfide amide Silica (PhosphonicS STA3) white solid Note: Sold in collaboration with PhosphonicS Ltd. for research purposes only. PhosphonicS Metals Scavenging Kit component and applications.		10g 50g

Silica size: 60-200 microns

Pore size: 60Å

Loading: 0.9 mmol/g

Scavenges: Al(III), VO(II), Cr(III), Fe(III), Co(II), Ni(II), Cu(II), Zn(II), Ga(III), Sr(II), Ru(III), Rh(I), Rh(III), Pd(0), Pd(II), Ag(I), Cd(II), Sn(II), Sn(IV), Pt(II), Hg(II), Pb(II), UO2(II)

MOFS AND LIGANDS FOR MOF SYNTHESIS (Compounds)

08-0175	[1,1'-Biphenyl]-4,4'-dicarboxylic acid, min. 98% (787-70-2) See page 215		
29-3015	Bis(1,4-diazabicyclo [2.2.2]octane)tetra (copper(I) iodide) (Cu)₄(DABCO)₂ (928170-42-7) See page 54		
29-0550	Bis(N,N'-dimethylpiperazine)tetra[copper(I) iodide], 98% MOF (1401708-91-5) See page 55		
08-1220	2,5-Dihydroxyterephthalic acid, 98% H₂DOBDC (610-92-4) See page 217		
15-7170	2-(Diphenylphosphino)terephthalic acid, 98% (1537175-69-1) See page 309		
07-0435	1,4-Di(4'-pyrazolyl)benzene, min. 97% H₂BDP (1036248-62-0) See page 199		
29-0565	(Hexamethylenetetramine)penta[copper(I) cyanide], 98% MOF (1042093-98-0) See page 58		
26-3725	Iron azobenzene tetracarboxylic, Porous [PCN-250(Fe)], CONEKTIC™ F250 (1771755-22-6) See page 106		
26-2340	Iron(III) 1,3,5-benzenetricarboxylate hydrate, porous (F-free MIL-100(Fe), KRICT F100) [Iron trimesate] (1257379-83-1) See page 107		
08-1235	2,6-Naphthalenedicarboxylic acid, min. 98% (1141-38-4) See page 219		
08-1165	1,4-Phenylenediacetic acid, 97% (7325-46-4) See page 220		

MOFS AND LIGANDS FOR MOF SYNTHESIS (Compounds)

07-1942	1,4,7,10-Tetraazacyclododecane-N,N',N'',N'''-tetraacetic acid, min. 98% DOTA (60239-18-1) See page 207	
08-0195	1,3,5-Tricarboxybenzene, min. 95% (Trimesic acid) BTC (554-95-0) See page 221	
07-3110	Tris(isobutylaminoethyl)amine, min 97% (331465-73-7) See page 212	
30-4015	Zinc 2-methylimidazole MOF (ZIF-8) (59061-53-9) See page 453	
40-1105	Zirconium 1,4-dicarboxybenzene MOF (UiO-66) (1072413-80-9) See page 457	

MOLECULAR SIEVES (Other)

93-5414	Molecular sieves, 1/8" pellets (Linde 3A) (308080-99-1) off-white pellets	250g 1kg
93-5402	Molecular sieves, 1/16" pellets (Linde 3A) (308080-99-1) white pellets	250g 1kg
93-5401	Molecular sieves, -600 mesh powder (Linde 3A) (308080-99-1) white pwdr.	250g 1kg
93-5407	Molecular sieves, -14+30 beads (Linde 4A) (70955-01-0) off-white beads	250g 1kg
93-5406	Molecular sieves, -8+12 beads (Linde 4A) (70955-01-0) off-white beads	250g 1kg
93-5415	Molecular sieves, -4+8 beads (Linde 4A) (70955-01-0) off-white beads	250g 1kg
93-5405	Molecular sieves, 1/8" pellets (Linde 4A) (70955-01-0) off-white pellets	250g 1kg
93-5404	Molecular sieves, 1/16" pellets (Linde 4A) (70955-01-0) off-white pellets	250g 1kg
93-5403	Molecular sieves, -600 mesh powder (Linde 4A) (70955-01-0) white pwdr.	250g 1kg
93-5410	Molecular sieves, 1/8" pellets (Linde 5A) (69912-79-4) off-white pellets	250g 1kg
93-5409	Molecular sieves, 1/16" pellets (Linde 5A) (69912-79-4) off-white pellets	250g 1kg
93-5408	Molecular sieves, -600 mesh powder (Linde 5A) (69912-79-4) white pwdr.	500g 2kg
93-5413	Molecular sieves, 1/8" pellets (Linde 13X) (63231-69-6) off-white pellets	250g 1kg
93-5412	Molecular sieves, 1/16" pellets (Linde 13X) (63231-69-6) off-white pellets	250g 1kg
93-5411	Molecular sieves, -600 mesh powder (Linde 13X) (63231-69-6) off-white pwdr.	250g 1kg
14-8820	SBA-15 Molecular Sieve (7631-86-9) SA: 600-800 m ² /g	1g 5g
NEW		
14-8800	Type Y molecular sieve, ammonium ion, powder (1318-02-1) white pwdr.; SA: 948m ² /g	50g 250g 1kg
14-8960	Type Y molecular sieve, sodium ion, powder (1318-02-1) white pwdr.; SA: 900m ² /g	100g 500g 2kg

MOLYBDENUM (Elemental Forms)

42-0070	Molybdenum foil (99.95%) (7439-98-7) Mo; FW: 95.94; 0.25mm thick (-25.6g/100x 100mm); m.p. 2610°; b.p. 5560°; d. 10.2	100 x 100mm 150 x 300mm 300 x 300mm
---------	---	---

MOLYBDENUM (Elemental Forms)

42-0075	Molybdenum pellets (99.7%) (7439-98-7) Mo; FW: 95.94; 16 x 6 mm; m.p. 2610°; b.p. 5560°; d. 10.2	100g 500g
93-4257 HAZ	Molybdenum powder (99.9%) (7439-98-7) Mo; FW: 95.94; 3-7 micron; m.p. 2610°; b.p. 5560°; d. 10.2	100g 500g
93-4256 HAZ	Molybdenum powder (99.95%) (7439-98-7) Mo; FW: 95.94; -100 mesh; m.p. 2610°; b.p. 5560°; d. 10.2	100g 500g
93-4255	Molybdenum rod (99.95%) (7439-98-7) Mo; FW: 95.94; 6.4 mm dia. (~3.6g/cm); m.p. 2610°; b.p. 5560°; d. 10.2	50g 250g
42-0080	Molybdenum sheet (99.95%) (7439-98-7) Mo; FW: 95.94; 2.5mm thick (~64g/50 x 50mm); m.p. 2610°; b.p. 5560°; d. 10.2	50 x 50mm 100 x 100mm 500 x 100mm
42-0010	Molybdenum wire (99.97%) (7439-98-7) Mo; FW: 95.94; 2.0mm dia. (32.1g/m); m.p. 2610°; b.p. 5560°; d. 10.2	100cm 500cm
93-4252	Molybdenum wire (99.97%) (7439-98-7) Mo; FW: 95.94; 0.5 mm dia.; m.p. 2610°; b.p. 5560°; d. 10.2	25m 100m
93-4254	Molybdenum wire (99.97%) (7439-98-7) Mo; FW: 95.94; 0.25 mm dia.; m.p. 2610°; b.p. 5560°; d. 10.2	25m 100m
93-4259	Molybdenum wire (99.97%) (7439-98-7) Mo; FW: 95.94; 0.05 mm dia.; m.p. 2610°; b.p. 5560°; d. 10.2	250m 1000m

MOLYBDENUM (Compounds)

02-0745	Ammonium molybdate tetrahydrate (99.98%-Mo) (12027-67-7) See page 6	
02-0750	Ammonium molybdate tetrahydrate (99.999%-Mo) PURATREM (12027-67-7) See page 6	
93-0245	Ammonium molybdate tetrahydrate (ACS) (12027-67-7) See page 6	
42-1000	Ammonium tetrathiomolybdate(VI), 99% (99.99%-Mo) PURATREM (15060-55-6) See page 7	
42-9028	Bis(acetonitrile)tetracarbonylmolybdenum(0), 98% (14126-87-5) NEW C ₈ H ₈ N ₂ O ₄ Mo; FW: 290.08; yellow solid <i>air sensitive</i>	250mg 1g 5g
42-0215	Bis(t-butylimido)bis(dimethylamino)molybdenum(VI), 98% (923956-62-1) NEW C ₁₂ H ₃₀ MoN ₄ ; FW: 326.33; orange liq. <i>air sensitive, moisture sensitive, (store cold)</i>	500mg 2g
42-0100	Bis(cyclopentadienyl)molybdenum dichloride, 99% (12184-22-4) (C ₅ H ₅) ₂ MoCl ₂ ; FW: 297.04; greenish-brown powder. <i>air sensitive, moisture sensitive</i>	1g 5g
42-0200 amp HAZ	Bis(ethylbenzene)molybdenum [mixture of (C₂H₅)₂C₆H₆]^x where x = 0-4] (32877-00-2) [(C ₂ H ₅) ₂ C ₆ H ₆] _x Mo; dark green liq.; b.p. 150-170°/1mm <i>air sensitive</i>	1g 5g 25g
27-0480	Cobalt oxide-molybdenum oxide on alumina (3.5% CoO, 14% MoO₃) (1308-06-1) See page 49	
42-0350 amp	Cycloheptatriene molybdenum tricarbonyl, 99% (12125-77-8) C ₇ H ₈ Mo(CO) ₃ ; FW: 272.11; orange to red xtl.; m.p. 100-101° <i>air sensitive, (store cold)</i>	1g 5g

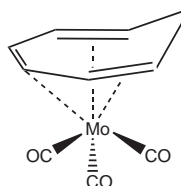
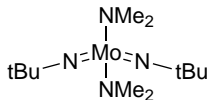

MOLYBDENUM (Compounds)

42-0390 HAZ	Cyclopentadienylmolybdenum(V) tetrachloride, min. 95% (62927-99-5) C ₅ H ₅ MoCl ₄ ; FW: 302.85; red to purple powdr. <i>air sensitive, moisture sensitive</i>		1g 5g
42-0400	Cyclopentadienylmolybdenum tricarbonyl dimer, min. 98% (12091-64-4) [C ₅ H ₅ Mo(CO) ₃] ₂ ; FW: 490.14; red to purple xtl.; m.p. 220° dec. <i>air sensitive</i>		5g 25g
42-1213 amp	2,6-Diisopropylphenylimidoneophylidene [(R)-(+)-BIPHEN]molybdenum(VI), min. 97% (R) SCHROCK-HOVEYDA CATALYST (329735-77-5) Mo(C ₁₀ H ₁₂)(C ₁₂ H ₁₇ N)(C ₂₄ H ₃₂ O ₂); FW: 755.93; red xtl. <i>air sensitive, moisture sensitive, (store cold)</i> For detailed technical note visit strem.com .		25mg 100mg
42-1214 amp	2,6-Diisopropylphenylimidoneophylidene[(S)-(-)-BIPHEN]molybdenum(VI), min. 97% (S) SCHROCK-HOVEYDA CATALYST (205815-80-1) Mo(C ₁₀ H ₁₂)(C ₁₂ H ₁₇ N)(C ₂₄ H ₃₂ O ₂); FW: 755.93; red xtl. <i>air sensitive, moisture sensitive, (store cold)</i> For detailed technical note visit strem.com .		25mg 100mg
42-1200 amp	2,6-Diisopropylphenylimidoneophylidene molybdenum(VI) bis(t-butoxide) (126949-65-3) Mo(C ₁₀ H ₁₂)(C ₁₂ H ₁₇ N)(OC ₄ H ₉) ₂ ; FW: 549.65; yellow to orange powdr. <i>air sensitive, moisture sensitive, (store cold)</i> For detailed technical note visit strem.com .		100mg 500mg
42-1205 amp	2,6-Diisopropylphenylimidoneophylidene molybdenum(VI) bis(hexafluoro-t-butoxide) SCHROCK'S CATALYST (139220-25-0) Mo(C ₁₀ H ₁₂)(C ₁₂ H ₁₇ N)[OC(CH ₃)(CF ₃) ₂] ₂ ; FW: 765.53; yellow to orange powdr. <i>air sensitive, moisture sensitive, (store cold)</i> For detailed technical note visit strem.com .		100mg 500mg 2g
42-1210	2,6-Diisopropylphenylimido neophylidene-molybdenum(VI) bis(trifluoromethanesulfonate) dimethoxyethane adduct (126949-63-1) Mo(C ₁₀ H ₁₂)(C ₁₂ H ₁₇ N)(OSO ₂ CF ₃) ₂ (C ₄ H ₁₀ O ₂); FW: 791.68; yellow to orange powdr. <i>air sensitive, moisture sensitive, (store cold)</i> Note: **Limited quantities available** For detailed technical note visit strem.com .		100mg
42-1212 amp	2,6-Diisopropylphenylimidoneophylidene[racemic-BIPHEN]molybdenum(VI), min. 97% rac-SCHROCK-HOVEYDA CATALYST (300344-02-9) Mo(C ₁₀ H ₁₂)(C ₁₂ H ₁₇ N)(C ₂₄ H ₃₂ O ₂); FW: 755.93; red xtl. <i>air sensitive, moisture sensitive, (store cold)</i> For detailed technical note visit strem.com .		100mg 500mg
42-1220	Molybdenum(II) acetate dimer, 99% (14221-06-8) Mo ₂ (OOCCH ₃) ₄ ; FW: 428.06; yellow xtl. <i>air sensitive, (store cold)</i>		1g 5g
93-4243	Molybdenum carbide (99.5%-Mo) (12069-89-5) Mo ₂ C; FW: 203.91; gray powdr.; m.p. 2687°; d. 9.18		50g 250g
42-1350 HAZ	Molybdenum carbonyl, 98% (13939-06-5) Mo(CO) ₆ ; FW: 264.01; white xtl.; m.p. 150-151° dec.		5g 25g 100g 500g
93-4214 amp HAZ	Molybdenum(III) chloride (99.5%-Mo) (13478-18-7) MoCl ₃ ; FW: 202.32; -100 mesh dark red-brown solid; m.p. dec.; d. 3.59 <i>air sensitive, moisture sensitive</i>		1g 5g 25g

MOLYBDENUM (Compounds)

42-1390 HAZ	Molybdenum(V) chloride, anhydrous, 99.6% (10241-05-1) MoCl ₅ ; FW: 273.20; dark blue xtl.; m.p. 194°; b.p. 268° <i>air sensitive, moisture sensitive</i>	50g 250g 1kg
93-4217	Molybdenum(VI) dioxide bis(acetylacetonate), min. 95% (17524-05-9) MoO ₂ (CH ₃ C(O)CHC(O)CH ₃) ₂ ; FW: 326.16; yellow to orange pwdr.; m.p. 181°	5g 25g
42-1357	Molybdenum(VI) dioxide bis(2,2,6,6-tetramethyl-3,5-heptanedionate), min. 98% [O ₂ Mo(TMHD) ₂] (34872-98-5) MoO ₂ (C ₁₁ H ₁₈ O ₂) ₂ ; FW: 494.48; yellow xtl.; m.p. 129-131° <i>moisture sensitive</i>	1g 5g 25g
42-1550 NEW	Molybdenum disilicide, 0.4-5.0 microns (99+% Mo) (12136-78-6) MoSi ₂ ; FW: 152.13; black solid	50g 250g
42-1400	Molybdenum(IV) 2-ethylhexanoate (15% Mo) (34041-09-3) Mo[OOCCH(C ₂ H ₅)C ₄ H ₉] ₂ ; FW: 668.75; reddish-brown liq.; f.p. 250°F; d. 1.11-1.15	100g 500g
93-4246	Molybdenum(IV) oxide, 99% (18868-43-4) MoO ₃ ; FW: 127.95; purple pwdr.; d. 6.47	10g 50g
93-4215	Molybdenum(VI) oxide, 99.5+% (1313-27-5) MoO ₃ ; FW: 143.95; pale green pwdr.; m.p. 795°; b.p. subl.; d. 4.69	50g 250g
42-1475	Molybdenum(VI) oxide (99.998% Mo) PURATREM (1313-27-5) MoO ₃ ; FW: 143.95; pale green pwdr.; m.p. 795°; b.p. subl.; d. 4.69	10g 50g
42-1476	Molybdenum(VI) oxide (99.999% Mo) PURATREM (1313-27-5) MoO ₃ ; FW: 143.95; pale green pwdr.; m.p. 795°; b.p. subl.; d. 4.69	10g 50g
93-4211	Molybdenum(IV) selenide (99.9% Mo) (12058-18-3) MoSe ₂ ; FW: 253.87; -325 mesh gray pwdr.; m.p. > 1200°; d. 6.0	5g 25g
93-4212	Molybdenum silicide (99+% Mo) (12136-78-6) MoSi ₂ ; FW: 152.13; black pwdr.; d. 6.31	25g 100g
93-4247	Molybdenum(IV) sulfide, 97+% (1317-33-5) MoS ₂ ; FW: 160.08; black pwdr.; m.p. 1185°; d. 4.80	100g 500g
93-4209 HAZ	Molybdenum(VI) tetrachloride oxide, min. 97% (13814-75-0) MoOCl ₄ ; FW: 253.78; green pwdr.; m.p. 100-101° <i>air sensitive, moisture sensitive, (store cold)</i>	5g 25g
93-4249 HAZ	12-Molybdophosphoric acid hydrate (ACS) (51429-74-4) H ₃ PO ₄ ·12MoO ₃ ·XH ₂ O; FW: 1825.25; yellow xtl.	10g 50g
93-4216	12-Molybdosilicic acid hydrate (11089-20-6) H ₄ [Si(Mo ₃ O ₁₀) ₄]·XH ₂ O; FW: 1823.40; yellow xtl.	10g 50g
42-1600 HAZ	Oxidoperoxy(pyridine)(1,3-dimethyl-3,4,5,6-tetrahydro-2(1H)-pyrimidinone)molybdenum(IV), min. 95% (128575-71-3) MoO ₅ (C ₈ H ₉ N)(C ₆ H ₁₂ N ₂ O); FW: 383.21; pale yellow xtl.; m.p. dec. <i>heat sensitive, light sensitive, (store cold)</i> For detailed technical note visit strem.com .	1g 5g
42-2200	Pentamethylcyclopentadienylmolybdenum dicarbonyl dimer, 99% (12132-04-6) [(CH ₃) ₅ C ₅ Mo(CO) ₂] ₂ ; FW: 574.38; red xtl.; m.p. 219° dec.	1g 5g
42-8000	Tricarbonyltris(propionitrile)molybdenum (O), min. 95% (103933-26-2) Mo(CO) ₃ (NCCH ₂ CH ₃) ₃ ; FW: 345.21; tan pwdr. <i>air sensitive, moisture sensitive</i>	250mg 1g
42-7500 HAZ	Trichlorotris(tetrahydrofuran)molybdenum(III), min. 95% (31355-55-2) MoCl ₃ (C ₄ H ₈ O) ₃ ; FW: 418.62; light orange solid <i>moisture sensitive</i>	1g 5g

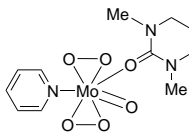
**NANOMATERIALS - ALUMINUM (Compounds)**

13-1400	Aluminum oxide nanopowder (1344-28-1) Al ₂ O ₃ ; FW: 101.96; white pwdr.	50g 250g
---------	--	-------------

Specific Surface Area (BET): ≤275 m²/g; **True Density:** 3.9 g/cc; **Crystallite Size:** Amorphous; **Mean Aggregate Size:** 1.5 μm; **Average Pore Diameter:** 28Å; **Loss on Ignition:** 2.1%; **Total Pore Volume:** ≥0.15 cc/g; **Al Content (Based on Metal):** >99.8%; **Bulk Density:** 0.5 g/cc

NANOMATERIALS - CADMIUM (Compounds)**Cadmium selenide CANdot® quantum dot (CdSe core), 50umol/L in hexanes (1306-24-7)***air sensitive, (store cold)*

Note: Sold in collaboration with CAN for research purposes. Cadmium selenide CANdot® quantum dot (core) kit components. See page 533

48-1011 HAZ	Cadmium selenide CANdot® quantum dot (CdSe core), 50umol/L in hexanes, 525nm peak emission (1306-24-7) CdSe; orange liq. <i>air sensitive, (store cold)</i>	5ml 25ml
48-1017 HAZ	Cadmium selenide CANdot® quantum dot (CdSe core), 50umol/L in hexanes, 550nm peak emission (1306-24-7) CdSe; red-orange liq. <i>air sensitive, (store cold)</i>	5ml 25ml
48-1023 HAZ	Cadmium selenide CANdot® quantum dot (CdSe core), 50umol/L in hexanes, 575nm peak emission (1306-24-7) CdSe; red liq. <i>air sensitive, (store cold)</i>	5ml 25ml
48-1030 HAZ	Cadmium selenide CANdot® quantum dot (CdSe core), 50umol/L in hexanes, 600nm peak emission (1306-24-7) red liq. <i>air sensitive, (store cold)</i>	5ml 25ml
48-1035 HAZ	Cadmium selenide CANdot® quantum dot (CdSe core), 50umol/L in hexanes, 625nm peak emission (1306-24-7) red liq. <i>air sensitive, (store cold)</i>	5ml 25ml
96-0800	Cadmium selenide CANdot® quantum dot (CdSe core) kit, 50umol/L in hexanes, 525-625nm peak emissions (1306-24-7) See page 533	5ml 25ml

CANdot® Quantum Rods (1306-24-7)

Store at 2-8°C in dark under inert atmosphere. Do not freeze. Stable for >12 months

Note: Sold in collaboration with CAN for research purposes. Cadmium selenide/cadmium sulfide CANdot® quantum rod kit components. See page 533

48-1053 HAZ	Cadmium selenide/cadmium sulfide CANdot® quantum rod (CdSe/CdS elongated core/shell), 5 mg/ml in hexanes, 560nm peak emission (1306-24-7) CdSe/CdS; dispersed, yellow solution; <i>(store cold)</i>	0.5ml 2ml
48-1056 HAZ	Cadmium selenide/cadmium sulfide CANdot® quantum rod (CdSe/CdS elongated core/shell), 5 mg/ml in hexanes, 590nm peak emission (1306-24-7) CdSe/CdS; dispersed, orange solution; <i>(store cold)</i>	0.5ml 2ml
48-1059 HAZ	Cadmium selenide/cadmium sulfide CANdot® quantum rod (CdSe/CdS elongated core/shell), 5 mg/ml in hexanes, 620nm peak emission (1306-24-7) CdSe/CdS; dispersed, red solution; <i>(store cold)</i>	0.5ml 2ml
96-0813	Cadmium selenide/cadmium sulfide CANdot® quantum rod kit (CdSe/CdS elongated core/shell), 5 mg/ml in hexanes, 560nm, 590nm, 620nm peak emissions (1306-24-7) See page 533	0.5ml 2ml

CdSe/ZnS - Solid Quantum Dots

Note: Each product below is a group of highly purified CdSe/ZnS quantum dots in solid form. The surface ligand is octadecylamine. The quantum dots can be dispersed in most organic solvents such as toluene, chloroform, and hexane. These quantum dots are specifically designed as emitters for optoelectronic applications such as LEDs.

48-1618 HAZ	Cadmium selenide/Zinc sulfide quantum dots in solid form, Emission peak: 520nm, FWHM <35nm, QY >50% orange to red pwdr.	10mg 50mg
Technical Note: 1. See 48-1614 (page 142)		
48-1620 HAZ	Cadmium selenide/Zinc sulfide quantum dots in solid form, Emission peak: 560nm, FWHM <35nm, QY >50% orange pwdr.	10mg 50mg
Technical Note: 1. See 48-1614 (page 142)		
48-1622 HAZ	Cadmium selenide/Zinc sulfide quantum dots in solid form, Emission peak: 600nm, FWHM <25nm, QY >50% red pwdr.	10mg 50mg
Technical Note: 1. See 48-1614 (page 142)		
48-1624 HAZ	Cadmium selenide/Zinc sulfide quantum dots in solid form, Emission peak: 630nm, FWHM <25nm, QY >50% red pwdr.	10mg 50mg
Technical Note: 1. See 48-1614 (page 142)		

NANOMATERIALS - CADMIUM (Compounds)**CdSe/ZnS - Solid Quantum Dots with Amine in water**

Note: A water-soluble CdS/ZnS or CdSSe/ZnS core/shell quantum dots with amphiphilic polymer and PEG coating. Reactive group is an amine.

48-1666	Cadmium selenide/Zinc sulfide core/shell quantum dots with Amine in water	2nmole
HAZ	Emission peak: 580 nm FWHM <25nm QY>50% orange liq.	10nmole

Technical Note:

1. See 48-1658 (page 142)

48-1668	Cadmium selenide/Zinc sulfide core/shell quantum dots with Amine in water	2nmole
HAZ	Emission peak: 620 nm FWHM <25nm QY>50% red liq.	10nmole

Technical Note:

1. See 48-1658 (page 142)

CdSe/ZnS - Solid Quantum Dots with carboxylic acid in water

Note: A water-soluble CdSe/ZnS core/shell quantum dots with amphiphilic polymer and PEG coating. Reactive group is a carboxylic acid.

48-1638	Cadmium selenide/Zinc sulfide core/shell quantum dots with carboxylic acid in water	4nmole
HAZ	Emission peak: 580 nm FWHM <25nm QY>50% orange liq.	20nmole

Technical Note:

1. See 48-1630 (page 143)

48-1640	Cadmium selenide/Zinc sulfide core/shell quantum dots with carboxylic acid in water	4nmole
HAZ	Emission peak: 620 nm FWHM <25nm QY>50% red liq.	20nmole

Technical Note:

1. See 48-1630 (page 143)

CdSe/ZnS - Solid Quantum Dots with PEG in water

Note: A water-soluble CdSe/ZnS core/shell quantum dots with amphiphilic polymer and PEG coating. Reactive group is a carboxylic acid.

48-1652	Cadmium selenide/Zinc sulfide core/shell quantum dots with PEG in water	2nmole
HAZ	Emission peak: 580 nm FWHM <25nm QY>50% orange liq.	10nmole

Technical Note:

1. See 48-1644 (page 143)

48-1654	Cadmium selenide/Zinc sulfide core/shell quantum dots with PEG in water	2nmole
HAZ	Emission peak: 620 nm FWHM <25nm QY>50% red liq.	10nmole

Note: A water-soluble CdSe/ZnS core/shell quantum dots with amphiphilic polymer and PEG coating. Reactive group is a carboxylic acid.

Technical Note:

1. See 48-1644 (page 143)

CdSSe/ZnS - Solid Quantum Dots

Note: Group of highly purified CdSSe/ZnS quantum dots in solid form. The surface ligand is oleic acid. The quantum dots can be dispersed in most organic solvents such as toluene, chloroform, and hexane. These quantum dots are specifically designed as emitters for optoelectronic applications such as LEDs.

48-1602	Cadmium sulfide selenide/Zinc sulfide quantum dots in solid form	10mg
HAZ	Emission peak: 450nm, FWHM <35nm, QY >50% green pwdr.	50mg

48-1604	Cadmium sulfide selenide/Zinc sulfide quantum dots in solid form	10mg
HAZ	Emission peak: 490nm, FWHM <35nm, QY >50% green pwdr.	50mg

48-1606	Cadmium sulfide selenide/Zinc sulfide quantum dots in solid form	10mg
HAZ	Emission peak: 540nm, FWHM <35nm, QY >50% orange pwdr.	50mg

48-1608	Cadmium sulfide selenide/Zinc sulfide quantum dots in solid form	10mg
HAZ	Emission peak: 600nm, FWHM <35nm, QY >50% red pwdr.	50mg

48-1610	Cadmium sulfide selenide/Zinc sulfide quantum dots in solid form	10mg
HAZ	Emission peak: 630nm, FWHM <35nm, QY >50% red pwdr.	50mg

48-1612	Cadmium sulfide selenide/Zinc sulfide quantum dots in solid form	10mg
HAZ	Emission peak: 665nm, FWHM <35nm, QY >50% brown pwdr.	50mg

NANOMATERIALS - CADMIUM (Compounds)**CdSSe/ZnS - Solid Quantum Dots with Amine in water**

Note: A water-soluble CdS/ZnS or CdSSe/ZnS core/shell quantum dots with amphiphilic polymer and PEG coating. Reactive group is an amine.

48-1662	Cadmium sulfide selenide/Zinc sulfide core/shell quantum dots with Amine in water	2nmole
HAZ	Emission peak: 490 nm FWHM <35nm QY>50% yellow liq	10nmole

Technical Note:

1. See 48-1658 (page 142)

48-1664	Cadmium sulfide selenide/Zinc sulfide core/shell quantum dots with Amine in water	2nmole
HAZ	Emission peak: 525 nm FWHM <35nm QY>50% yellow-green liq	10nmole

Technical Note:

1. See 48-1658 (page 142)

48-1670	Cadmium sulfide selenide/Zinc sulfide core/shell quantum dots with Amine in water	2nmole
HAZ	Emission peak: 665 nm FWHM <35nm QY>50% dark red liq.	10nmole

Technical Note:

1. See 48-1644 (page 143)

CdSSe/ZnS - Solid Quantum Dots with carboxylic acid in water

Note: A water-soluble CdSSe/ZnS core/shell quantum dots with amphiphilic polymer and PEG coating. Reactive group is a carboxylic acid.

48-1634	Cadmium sulfide selenide/Zinc sulfide core/shell quantum dots with carboxylic acid in water	4nmole
HAZ	Emission peak: 490 nm FWHM <35nm QY>50% yellow liq.	20nmole

Technical Note:

1. See 48-1630 (page 143)

48-1636	Cadmium sulfide selenide/Zinc sulfide core/shell quantum dots with carboxylic acid in water	4nmole
HAZ	Emission peak: 525 nm FWHM <35nm QY>50% yellow-green liq.	20nmole

Technical Note:

1. See 48-1630 (page 143)

48-1642	Cadmium sulfide selenide/Zinc sulfide core/shell quantum dots with carboxylic acid in water	4nmole
HAZ	Emission peak: 665 nm FWHM <35nm QY>50% dark red liq.	20nmole

Technical Note:

1. See 48-1630 (page 143)

CdSSe/ZnS - Solid Quantum Dots with PEG in water

Note: A water-soluble CdSSe/ZnS core/shell quantum dots with amphiphilic polymer and PEG coating. Reactive group is a carboxylic acid.

48-1648	Cadmium sulfide selenide/Zinc sulfide core/shell quantum dots with PEG in water	2nmole
HAZ	Emission peak: 490 nm FWHM <35nm QY>50% yellow liq.	10nmole

Technical Note:

1. See 48-1644 (page 143)

48-1650	Cadmium sulfide selenide/Zinc sulfide core/shell quantum dots with PEG in water	2nmole
HAZ	Emission peak: 525 nm FWHM <35nm QY>50% yellow-green liq.	10nmole

Technical Note:

1. See 48-1644 (page 143)

48-1656	Cadmium sulfide selenide/Zinc sulfide core/shell quantum dots with PEG in water	2nmole
HAZ	Emission peak: 665 nm FWHM <35nm QY>50% dark red liq.	10nmole

Technical Note:

1. See 48-1644 (page 143)

NANOMATERIALS - CADMIUM (Compounds)**CdS/ZnS - Solid Quantum Dots**

48-1614	Cadmium sulfide/Zinc sulfide quantum dots in solid form, Emission peak: 400nm,	10mg
HAZ	FWHM <35nm, QY >50% white powdr.	50mg

Note: 48-1614 is a group of highly purified CdS/ZnS quantum dots in solid form. The surface ligand is octadecylamine. The quantum dots can be dispersed in most organic solvents such as toluene, chloroform, and hexane. These quantum dots are specifically designed as emitters for optoelectronic applications such as LEDs.

Technical Note:

- Group of highly purified CdS/Zns or CdSe/ZnS quantum dots in solid form. The surface ligand is octadecylamine. The quantum dots can be dispersed in most organic solvents such as toluene, chloroform, and hexane. These quantum dots are specifically designed as emitters for optoelectronic applications such as LEDs.

References:

- The Journal of Physical Chemistry C*, **2009**, 113, 1886
- ACS Nano*, **2009**, 3, 737
- Journal of Applied Physics*, **2009**, 105, 034312
- IEEE Photonics Technology Letters*, **2008**, 20, 1998
- Optical Letters*, **2008**, 33, 2437
- Applied Physics Letters*, **2008**, 92, 023111
- Journal of Experiment NanoScience*, **2007**, 2, 13
- Nanotechnology*, **2007**, 18, 025403
- Applied Physics Letters*, **2007**, 91, 023102
- Nature Photonics*, **2007**, 1, 717
- Nano Letters*, **2007**, 7, 3803

48-1616	Cadmium sulfide/Zinc sulfide quantum dots in solid form, Emission peak: 420nm,	10mg
HAZ	FWHM <35nm, QY >50% yellow powdr.	50mg

Note: 48-1616 is a group of highly purified CdS/ZnS quantum dots in solid form. The surface ligand is octadecylamine. The quantum dots can be dispersed in most organic solvents such as toluene, chloroform, and hexane. These quantum dots are specifically designed as emitters for optoelectronic applications such as LEDs.

Technical Note:

- See 48-1614 (page 142)

CdS/ZnS - Solid Quantum Dots with Amine in water

48-1658	Cadmium sulfide/Zinc sulfide core/shell quantum dots with Amine in water	2nmole
HAZ	Emission peak: 400 nm FWHM <35nm QY>50% light yellow liq.	10nmole

Note: 48-1658 is a water-soluble CdS/ZnS core shell quantum dots with amphiphilic polymer and PEG coating. Reactive group is an amine.

Technical Notes:

- Zeta potential of QSA is from -20mV to +10 mV.
- Organic layers consist of a monolayer of oleic acid/octadecylamine, a monolayer of amphiphilic polymer, and a monolayer of PEG.
- Total thickness of organic layers is ~6 nm.
- The hydrodynamic size of the QDs is about 12-14 nm larger than their inorganic core size as measured by TEM.
- QSA is very stable in most buffer solutions in the pH range of 5-10, and can survive autoclaving processes of 121°C for 30 mins.
- Amine density is low due to the long PEG chain.

References:

- Small*, **2009**, 5, 235

48-1660	Cadmium sulfide/Zinc sulfide core/shell quantum dots with Amine in water	2nmole
HAZ	Emission peak: 450 nm FWHM <35nm QY>50% yellow liq.	10nmole

Note: A water-soluble CdS/ZnS or CdSSe/Zn core shell quantum dots with amphiphilic polymer and PEG coating. Reactive group is an amine.

Technical Note:

- See 48-1658 (page 142)

NANOMATERIALS - CADMIUM (Compounds)**CdS/ZnS - Solid Quantum Dots with carboxylic acid in water**

Note: A water-soluble CdS/ZnS core/shell quantum dots with amphiphilic polymer and PEG coating. Reactive group is a carboxylic acid

48-1630	Cadmium sulfide/Zinc sulfide core/shell quantum dots with carboxylic acid in water	4nmole
HAZ	Emission peak: 400 nm FWHM <35nm QY>50% light yellow liq.	20nmole

Technical Notes:

1. Zeta potential of QSA is from -30mV to -50 mV.
2. Organic layers consist of a monolayer of oleic acid/octadecylamine and a monolayer of amphiphilic polymer.
3. Total thickness of organic layers is ~4 nm.
4. The hydrodynamic size of the QDs is about 8-10 nm larger than their inorganic core size as measured by TEM.
5. QSH is very stable in most buffer solutions in the pH range of 5-10, and can survive autoclaving processes of 121°C for 30 mins.

References:

1. *Small*, **2009**, 5, 235

48-1632	Cadmium sulfide/Zinc sulfide core/shell quantum dots with carboxylic acid in water	4nmole
HAZ	Emission peak: 450 nm FWHM <35nm QY>50% yellow liq.	20nmole

Technical Note:

1. See 48-1630 (page 143)

CdS/ZnS - Solid Quantum Dots with PEG in water

48-1644	Cadmium sulfide/Zinc sulfide core/shell quantum dots with PEG in water	2nmole
HAZ	Emission peak: 400 nm FWHM <35nm QY>50% light yellow liq.	10nmole

Note: A water-soluble alloy CdSSe/ZnS or CdSe/Zn core/shell quantum dots with amphiphilic polymer. Their reactive group is a carboxylic acid.

Technical Notes:

1. Zeta potential of QSA is from -30mV to -50 mV.
2. Total thickness of organic layers is ~4 nm.
3. The organic layers consist of a monolayer of oleic acid/octadecylamine and a monolayer of amphiphilic polymer.
4. The hydrodynamic size of the quantum dots is about 8-10 nm larger than their inorganic core size as measured by TEM.
5. The product is stable in most buffer solutions in the pH range of 5-10.

48-1646	Cadmium sulfide/Zinc sulfide core/shell quantum dots with PEG in water	2nmole
HAZ	Emission peak: 450 nm FWHM <35nm QY>50% yellow liq.	10nmole

Note: A water-soluble CdS/ZnS core/shell quantum dots with amphiphilic polymer and PEG coating. Reactive group is a carboxylic acid.

Technical Note:

1. See 48-1644 (page 143)

NANOMATERIALS - CARBON (Elemental Forms)**Carbon, Graphene**

06-0274	Graphene film, monolayer, on copper foil (1cm x 1cm) (1034343-98-0) C; foil	2pcs
----------------	--	------

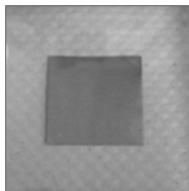

100% coverage, >95% single atomic layer

Average grain (crystal/domain) size: >-100 micron

Average sheet resistance (on non-conductive substrate): 400 OPS (+/- 200 OPS)

Average transmission: T >96% (on transparent substrate, i.e. ~4% lower than substrate T)

06-0310	Graphene film, monolayer, on Si/SiO₂ wafer (1cm x 1cm), by CVD	1pc
NEW	(1034343-98-0) C; FW: 12.011; wafer	

06-0323	Graphene oxide (0.8-1.2nm thick x 1-15 microns wide, made by the Staudenmaier Method)	250mg
NEW	black powdr.; SA: 5-10 m ² /g	1g

NANOMATERIALS - CARBON (Elemental Forms)**Carbon, Graphene**

06-2545	Graphene oxide (4mg/ml water dispersion) (1034343-98-0)	50ml
NEW	yellow-brown liq. dispersion	250ml

Physical Properties:

Form: Dispersion of graphene oxide sheets; *Sheet dimension:* Variable; *Color:* Yellow-brown; *Dispersibility:* Polar solvents; *Solvent:* Water; *pH:* 2.2-2.5; *Concentration:* 4 mg/mL; *Monolayer content (measured in 0.5 mg/mL):* >95%*

*Note: 4 mg/mL tends to agglomerate the GO flakes and dilution followed by slight sonication is required in order to obtain a higher percentage of monolayer flakes

Elemental Analysis: (sample preparation: 2g of 4 wt% GO in water were dried under vacuum at 60°C overnight)

Carbon: 49-56%; *Hydrogen:* 0-1%; *Nitrogen:* 0-1%; *Oxygen:* 41-50%; *Sulfur:* 0-2%

Quality Control:

Amount of residue on evaporation

pH control

Elemental analysis

Applications: Graphene/polymer composite materials, batteries, biomedical, solar cells, supercapacitors, support for metallic catalysts, low permeability materials, biosensors, multifunctional materials, graphene research

References:

1. *J. Mater. Chem.*, **2011**, *21*, 9762.
2. *Environ. Sci. Technol.*, **2013**, *47*, 3715.
3. *Phys. Chem. Chem. Phys.*, **2013**, *15*, 2321.

06-2550	Graphene oxide, reduced (1034343-98-0)	250mg
NEW	black powdr.	1g

Physical Properties:

Form: powder; *Reduction method:* chemically reduced; *Sheet dimension:* variable; *Color:* black; *Solubility:* insoluble; *Dispersibility:* <0.1 mg/mL in NMP, DMF, DMSO; *Humidity (Karl Fisher, TGA):* 3.7-4.2%; *Electrical conductivity:* 666,7 S/m (measured in a 20 nm film thickness); *BET surface area:* 422.69 - 499.85 m²/g; *Density:* 1.91 g/cm³

Elemental Analysis: (sample preparation: 2g of 4 wt% GO in water were dried under vacuum at 60°C overnight)

Carbon: 77-87%; *Hydrogen:* 0-1%; *Nitrogen:* 0-1%; *Oxygen:* 13-22%; *Sulfur:* 0%

Quality Control: Elemental analysis

Applications: Batteries, biomedical, solar cells, supercapacitors, printable graphene electronics, graphene research

References:

1. *Nano Letters*, **2010**, *10*, 92.
2. *J. Phys. Chem. Lett.*, **2013**, *4*, 1347.

06-0318	Graphene powder (1-5 layers thick x 0.5-5 microns wide, surface area 650-750 m²/g) (1034343-98-0)	250mg
NEW	C; FW: 12.011; black powdr.	1g

06-0313	Graphene powder (single layer, surface area 400-1000 m²/g) (1034343-98-0)	50mg
NEW	C; FW: 12.011; black powdr.	

06-2510	Monolayer Graphene on Cu (10 mm x 10 mm) (1034343-98-0)	4pcs
NEW	C; FW: 12.011; wafer	

Physical Properties:

Growth Method: Chemical Vapor Deposition (CVD synthesis); *Appearance:* Transparent; *Transparency:* >97%; *Coverage:* 98%; *Layers:* 1; *Thickness (theoretical):* 0.345 nm; *FET Electron Mobility on Al₂O₃:* 2000 cm²/Vs; *FET Electron Mobility on SiO₂:* 4000 cm²/Vs; *Sheet Resistance on SiO₂/Si:* 410-490 Ω/sq (1 cm x 1 cm); *Grain size:* Up to 10 μm

Substrate Cu foil:

Thickness: 18 μm

Pretreated for easier bottom layer removal: Monolayer graphene on the back side of Copper is partially removed, but not completely, so an additional treatment like RIE is needed before transfer to eliminate the bottom layer totally

Applications: Flexible batteries, electronics, aerospace, MEMS and NEMS, Microactuators, Conductive coatings

Quality Control: Raman Spectroscopy and Optical Microscopy

References:

1. *J. Electrochem. Soc.*, **2012**, *159*, A752.
2. *J. Mater. Chem. A.*, **2013**, *1*, 3177.

NANOMATERIALS - CARBON (Elemental Forms)**Carbon, Graphene****06-2518 Monolayer Graphene on Cu (60 mm x 40 mm) (1034343-98-0)**

1pc

NEW

C; FW: 12.011; wafer

Physical Properties:

Growth Method: Chemical Vapor Deposition (CVD synthesis); *Appearance:* Transparent; *Transparency:* >97%; *Coverage:* 95%; *Layers:* 1; *Thickness (theoretical):* 0.345 nm; *FET Electron Mobility on Al₂O₃:* 2000 cm²/Vs; *FET Electron Mobility on SiO₂:* 4000 cm²/Vs; *Sheet Resistance on SiO₂/Si:* 410-490 Ω/sq (1 cm x 1 cm); *Grain size:* Up to 10 μm

Substrate Cu foil:*Thickness:* 18 μm

Pretreated for easier bottom layer removal: Monolayer graphene on the back side of Copper is partially removed, but not completely, so an additional treatment like RIE is needed before transfer to eliminate the bottom layer totally

Applications: Flexible batteries, electronics, aerospace, MEMS and NEMS, Microactuators, Conductive coatings**Quality control:** Raman Spectroscopy and Optical Microscopy**References:**

1. *J. Electrochem. Soc.*, **2012**, 159, A752.
2. *J. Mater. Chem. A.*, **2013**, 1, 3177.

06-2523 Monolayer Graphene on Cu with PMMA coating (60mm x 40mm)

1pc

NEW

(1034343-98-0)

C; FW: 12.011; wafer

Physical Properties:

Growth Method: Chemical Vapor Deposition (CVD synthesis); *Appearance:* Transparent; *Transparency:* >97%; *Coverage:* 95%; *Layers:* 1; *Thickness (theoretical):* 0.345 nm; *FET Electron Mobility on Al₂O₃:* 2000 cm²/Vs; *FET Electron Mobility on SiO₂:* 4000 cm²/Vs; *Sheet Resistance on SiO₂/Si:* 410-490 Ω/sq (1 cm x 1 cm); *Grain size:* Up to 10 μm

Substrate Cu foil:*Thickness:* 18 μm

Pretreated for easier bottom layer removal: Monolayer graphene on the back side of Copper is partially removed, but not completely, so an additional treatment like RIE is needed before transfer to eliminate the bottom layer totally

Applications: Flexible batteries, electronics, aerospace, MEMS and NEMS, Microactuators, Conductive coatings**Quality control:** Raman Spectroscopy and Optical Microscopy**References:**

1. *J. Electrochem. Soc.*, **2012**, 159, A752.
2. *J. Mater. Chem. A.*, **2013**, 1, 3177.

06-2534 Monolayer Graphene on SiO₂/Si (10mm x 10mm) (1034343-98-0)

4pc

NEW

C; wafer

Physical Properties:

Growth Method: Chemical Vapor Deposition (CVD synthesis); *Appearance:* Transparent; *Transparency:* >97%; *Coverage:* 95%; *Layers:* 1; *Thickness (theoretical):* 0.345 nm; *FET Electron Mobility on Al₂O₃:* 2000 cm²/Vs; *FET Electron Mobility on SiO₂:* 4000 cm²/Vs; *Sheet Resistance on SiO₂/Si:* 410-490 Ω/sq (1 cm x 1 cm); *Grain size:* Up to 10 μm

Substrate Cu foil:

Dry Oxide Thickness: 285-315 nm; *Type/Dopant:* P/Bor; *Orientation:* <100>; *Resistivity:* <0.005 Ohm-cm; *Thickness:* 505-545 μm; *Front surface:* single side polished; *Back surface:* etched; *Particles:* <10@0.3 μm

Applications: Flexible batteries, electronics, aerospace, MEMS and NEMS, Microactuators, Conductive coatings**Quality control:** Raman Spectroscopy and Optical Microscopy**References:**

1. *J. Electrochem. Soc.*, **2012**, 159, A752
2. *J. Mater. Chem. A.*, **2013**, 1, 3177

NANOMATERIALS - CARBON (Elemental Forms)**Graphene Nanoplatelets**

06-0222	Graphene nanoplatelets, (2-10nm thick x ~5 microns wide) (1034343-98-0) C; black solid	5g 25g
NEW		
06-0210	Graphene nanoplatelets (6-8 nm thick x 5 microns wide) (1034343-98-0) C; black platelet Note: Graphene nanoplatelets are unique nanoparticles consisting of short stacks of graphene sheets having a platelet shape. They have an average thickness of approximately 6 - 8 nanometers and a typical surface area of 120 to 150 m ² /g. The unique size and platelet morphology of the graphene nanoplatelets makes these particles especially effective at providing barrier properties and improving mechanical properties, while their pure graphitic composition makes them excellent electrical and thermal conductors. For detailed technical note visit strem.com .	25g 100g
06-0215	Graphene nanoplatelets (6-8 nm thick x 15 microns wide) (1034343-98-0) C; black platelet	25g 100g
Technical Note: 1. See 06-0210 (page 146)		
06-0220	Graphene nanoplatelets (6-8 nm thick x 25 microns wide) (1034343-98-0) C; black platelet	25g 100g
Technical Note: 1. See 06-0210 (page 146)		
06-0225	Graphene nanoplatelets aggregates (sub-micron particles, surface area 300m²/g) (1034343-98-0) black platelet Note: Graphene nanoplatelet aggregates are unique nanoparticles consisting of short stacks of graphene sheets having a platelet shape. They typically consist of aggregates of sub-micron platelets that have a particle diameter of less than 2 microns and a typical particle thickness of a few nanometers, depending on the surface area. The unique size and platelet morphology of the graphene nanoplatelets makes these particles especially effective at providing barrier properties and improving mechanical properties, while their pure graphitic composition makes them excellent electrical and thermal conductors.	25g 100g
06-0230	Graphene nanoplatelets aggregates (sub-micron particles, surface area 500m²/g) (1034343-98-0) black platelet	25g 100g
Technical Note: 1. See 06-0225 (page 146)		
06-0235	Graphene nanoplatelets aggregates (sub-micron particles, surface area 750m²/g) (1034343-98-0) black platelet	25g 100g
Technical Note: 1. See 06-0225 (page 146)		

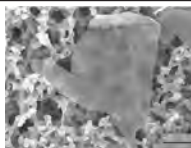

NANOMATERIALS - CARBON (Elemental Forms)**Graphene Quantum Dots (1034343-98-0)***light sensitive, (store cold)*

Note: Particle diameter: <5 nm. Sold in collaboration with Dotz Nano Ltd. for research purposes only. Suggested use within 6 months of purchase. Do not freeze. Store in DARK.

06-0330**Graphene Quantum Dots (GQDs), Aqua-Green Luminescent (1034343-98-0)**

100mg

NEW

C; dark red-brown pwdr.

Suggested Applications:

Graphene quantum dots (GQDs), sheets of few-layered graphene and lateral dimensions smaller than 100nm possess strong quantum confinement and edge effects. Thus, they possess unique physical properties such as strong photoluminescence, which can be tailored for specific applications by controlling their size, shape, defects and functionality.

In contrast to classic QDs, such as metal or silicon quantum dots, GQDs are biocompatible, photostable and inherit superior thermal, electrical and mechanical properties from the graphene. These features can greatly contribute to various state-of-the-art applications: optical brighteners, taggants for security applications¹, bioimaging markers², fluorescent polymers³, antibacterial⁴, antibiofouling⁵, and disinfection systems⁶, heavy metals⁷, humidity and pressure⁸ sensors, batteries⁹, flash memory devices¹⁰, photovoltaic devices¹¹ and light-emitting diodes¹².

Item #	Photoluminescence			
	QY* *	λ_{\max} *	Max emission	FWHM *
06-0330 / 06-0332	>17%	485 nm	525 nm	70 nm
06-0334 / 06-0336	>65%	350 nm	445 nm	65 nm
06-0338 / 06-0340	>25%	420 nm	490 nm	80 nm
Abbreviations				
	QY*	Quantum Yield		
	λ_{\max}	Maximum excitation wavelength		
	FWHM	Full width at half maximum		

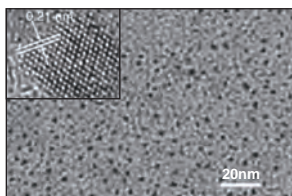
**References:**

1. <http://onlinelibrary.wiley.com/doi/10.1002/anie.201206791/abstract>
2. <http://onlinelibrary.wiley.com/doi/10.1002/ppsc.201400219/abstract>
3. <http://pubs.acs.org/doi/abs/10.1021/acsami.5b06057>
4. <http://pubs.acs.org/doi/abs/10.1021/acsami.6b01765>
5. <http://www.nature.com/articles/srep20142>
6. <http://pubs.acs.org/doi/abs/10.1021/nn501640q>
7. <http://www.sciencedirect.com/science/article/pii/S0013468615000468>
8. <http://pubs.acs.org/doi/abs/10.1021/nl4003443>
9. <http://pubs.acs.org/doi/abs/10.1021/nl504038s>
10. <http://iopscience.iop.org/article/10.1088/0957-4484/25/25/255203/meta>
11. <http://onlinelibrary.wiley.com/doi/10.1002/anie.200906291/abstract>
12. <http://link.springer.com/article/10.1007/s10853-012-7016-8>

06-0332**Graphene Quantum Dots (GQDs) in water, Aqua-Green Luminescent (1034343-98-0)**

100ml

NEW

C; cloudy orange liq.

Technical Note:

1. See 06-0330 (page 147)

06-0334**Graphene Quantum Dots (GQDs), Blue Luminescent (1034343-98-0)**

100mg

NEW

C; dark brown pwdr.

Technical Note:

1. See 06-0330 (page 147)

NANOMATERIALS - CARBON (Elemental Forms)**Graphene Quantum Dots (1034343-98-0)***light sensitive, (store cold)*

Note: Particle diameter: <5 nm. Sold in collaboration with Dotz Nano Ltd. for research purposes only. Suggested use within 6 months of purchase. Do not freeze. Store in DARK.

06-0336	Graphene Quantum Dots (GQDs) in water, Blue Luminescent (1034343-98-0)	100ml
	C; cloudy colorless liq.	

NEW

Technical Note:

- See 06-0330 (page 147)

06-0338	Graphene Quantum Dots (GQDs), Cyan Luminescent (1034343-98-0)	100mg
	C; dark brown powdr.	

NEW

Technical Note:

- See 06-0330 (page 147)

06-0340	Graphene Quantum Dots (GQDs) in water, Cyan Luminescent (1034343-98-0)	100ml
	C; cloudy brown liq.	

NEW

Technical Note:

- See 06-0330 (page 147)

96-7410	Graphene Quantum Dots (GQDs) Master Kit (1034343-98-0)	
	See page 536	

96-7425	Graphene Quantum Dots (GQDs) Mini Kit (Powders) (1034343-98-0)	
	See page 536	

96-7420	Graphene Quantum Dots in water (GQDs) Mini Kit (Liquids) (1034343-98-0)	
	See page 537	

Carbon Nanotubes

06-0440	Carbon nanotube array, multi-walled, on quartz (diameter=100nm, length=30 microns) (308068-56-6)	1pc
	black microfibers; (diameter=100nm, length=30microns)	



Technical Note:

- Arrays grown on 10x10x1mm quartz substrate using a single source CVD process that yields vertically aligned MWNTs (< 1% catalyst impurity). Arrays are 30µm tall (± 3µm) and are composed of MWNTs 100nm in diameter (± 10nm). Arrays up to 150µm can be provided on request.

06-0470	Carbon nanotubes, multi-walled (diameter = ~140nm, length = ~7 microns) (>90% nanotubes) (308068-56-6)	1g
	black powdr.	5g

Technical Note:

- Produced by chemical vapor deposition. Typical metal content is <0.1%.

06-0475	Carbon nanotubes, multi-walled (diameter = ~20-25nm, length = ~1-5 microns) (85% nanotubes) (308068-56-6)	250mg
	black powdr.	1g

Technical Note:

- Produced by chemical vapor deposition. Typical metal content is 4-5 wt %.

06-0720	Carbon nanotubes, multi-walled, arc-produced (diameter = 2-50nm, length = >2 microns) (55-65wt% nanotubes) (308068-56-6)	250mg
	black powdr.	1g

Technical Note:

- Arc-produced, multi-walled carbon nanotubes contain 55-65 wt% nanotubes and 35-45wt% graphite nanoparticles. The tubes have a diameter distribution of 2-50 nm, and a typical length of >2 microns (straight tubes). The chemical composition is 100% carbon, with no metal impurities. Because the nanotubes are grown at very high temperatures (3000-4000°C), the product contain far less defects than nanotubes produced by other methods. The nanotubes are stable in air up to 700°C.

06-0504	Carbon nanotubes, multi-walled, as produced cathode deposit (308068-56-6)	1g
	pieces	5g

06-0505	Carbon nanotubes, multi-walled, core material (308068-56-6)	1g
	pieces (20-40% nanotubes)	5g

06-0506	Carbon nanotubes, multi-walled, ground core material (308068-56-6)	250mg
	-270 mesh powdr. (20-40%nanotubes)	1g
		5g

NANOMATERIALS - CARBON (Elemental Forms)**Carbon Nanotubes**

06-0508	Carbon nanotubes, single-walled/double-walled, 90% (308068-56-6)	250mg
	powdr.	1g

Technical Note:

- This product is nanotubes, single-walled/double-walled, 90%. The tubes are 1-2nm in diameter with lengths of 5-30 microns. Ash is <1.5wt%.

06-1060	Polydiacetylene nanotube (PDNT-12-8-22Br)	100mg
	blue solid	500mg
	Note: Sold in collaboration with LIG Sciences for research purposes only. US Patent No. 7,666,911.	

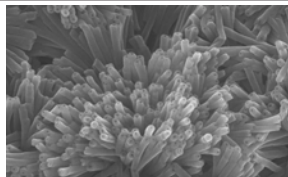

Technical Note:

- Polydiacetylene Nanotubes (PDNT) are self-assembled diacetylene nanotubes comprised of cross-linking of conjugated double and triple bonds. They are produced using a proprietary molecular self-assembly process that results in remarkably uniform, pure, air-stable blue nanotubes (ID 34nm, OD 98nm and length 1-3µm). PDNT nanotubes exhibit thermochromism either on different substrates or in solvents. This unique thermo- and mechano-chromic behavior has been demonstrated to be completely reversible for hundreds cycles.

NANOMATERIALS - CERIUM (Compounds)

58-0870	Mixed metal oxides of cerium(IV) [contains some Ce(III)] and iron(III) in octanoic acid and Kensol 50H (CEF-KE02)	50g
HAZ	rose-colored mixture; f.p. 230°; d. 0.84 (store cold)	250g
	Note: Store at 5 to 25°C. Do not freeze. Suggested use within 12 months of receipt. Sold in collaboration with Cerion for research purposes only.	

% Solids: 2.0 +/- 0.05%

Mean Number Weighted Particle Diameter: 2.5 Å ÷ 5.0 nm (by Dynamic Light Scattering)

Polydispersity Index: <0.25

Chemical Composition (particles): 40-58 wt% CeO₂ balance Fe₂O₃ by XRF

Residual Water: <0.35 wt% (by Karl Fischer)

Flashpoint: 230°F/110°C

58-0865	Mixed metal oxides of cerium(IV) [contains some Ce(III)] and iron(III) in water at pH 4.75 +0.25 (CEF-W420)	25g
HAZ	CeO ₂ /Fe ₂ O ₃ ; red-brown mixture; d. 1.23 (store cold)	100g
	Note: Store at 5 to 25°C. Do not freeze. Suggested use within 12 months of receipt. Sold in collaboration with Cerion for research purposes only.	500g

pH: 4.75 +/- 0.25

Useable pH Range: 3 - 5

Mean Number Weighted Particle Diameter: <5 nm (by Dynamic Light Scattering)

Polydispersity Index: <0.25

Chemical Composition (particles by XRF): 40 - 58wt% CeO₂, balance Fe₂O₃

58-0850	Cerium(IV) oxide [contains some Ce(III)] in water at pH = 9.0 +0.5 (CEO-W290)	25g
HAZ	(1306-38-3) CeO ₂ ; FW: 172.12; <5.0 nm, reddish-brown mixture; d. 1.23 (store cold)	100g
	Note: Store at 5 to 25°C. Do not freeze. Suggested use within 12 months of receipt. Sold in collaboration with Cerion for research purposes only.	500g

% Solids: 20.0 +/- 0.5%

pH: 9.0 +/- 0.5

Useable pH Range: 6-10

Mean Number Weighted Particle Diameter: 2.0 nm (by Dynamic Light Scattering)

Polydispersity Index: <0.25

Chemical Composition (particles): >99.5% CeO₂

Thermal Stability: Stable for >72 hours at 60°C

NANOMATERIALS - CERIUM (Compounds)

58-0860	Cerium(IV) oxide [contains some Ce(III)] in water at pH = 3.5 +/-0.75	25g
HAZ	(CEO-W320) (1306-38-3)	100g
	CeO ₂ ; FW: 172.12; red-brown mixture; d. 1.23	500g
	(store cold)	
	Note: Store at 5 to 25°C. Do not freeze. Suggested use within 12 months of receipt.	
	Sold in collaboration with Cerion for research purposes only.	

% Solids: 20 +/- 0.5%

pH: 3.5 +/- 0.75

Useable pH Range: 2-5

Mean Number Weighted Particle Diameter: 3.0 nm (by Dynamic Light Scattering)

Polydispersity Index: <0.25

Chemical Composition (particles): >99.5% CeO₂

58-1400	Cerium(IV) oxide nanopowder (1306-38-3)	25g
	CeO ₂ ; FW: 172.12; yellow powdr.	100g

NANOMATERIALS - COPPER (Elemental Forms)

29-0092	Copper nanoparticles, pure, (<20nm) in acetone at 100mg/L (surfactant and reactant-free) (7440-50-8)	25ml
HAZ	brown liq.	100ml
	Note: Made to order. Manufactured by laser ablation. Store at room temperature (up to 25°C). Do not freeze. Shelf life 12 months. Sold in collaboration with Particular® for research purposes only.	

NANOMATERIALS - GOLD (Elemental Forms)**Gold AUROLite™ Heterogeneous Catalysts**

(store cold)

Note: Sold in collaboration with Project AuTEK for research purposes. Reverse engineering and product modification prohibited. Only open before use, store cold in dark. See web for more details.

79-0160	Gold 1% on aluminum oxide extrudates (AUROLite™ Au/Al₂O₃) (7440-57-5)	10g
	dark purple extrudates ~1.2mm dia. x 5mm (avg)	50g

Technical Note:

- Useful product for the catalytic oxidation of a variety of substrates including carbon monoxide, aldehydes, alkenes, methane and ethanol. Average gold crystallite size is ~2-3nm.

Analysis: Au 1 wt% ± 0.1%; Al₂O₃ 98 wt%; Na+, Cl- <1500ppm**Bulk density:** 0.6–0.8 g/ml

References:

- J. Catal.*, **2007**, 252, 119
- J. Catal.*, **2008**, 260, 86
- Green Chem.*, **2008**, 10, 168
- Gold Bulletin*, **2008**, 41, 296
- Appl. Catal. B.*, **2013**, 132, 195
- Chem. Rev.*, **2012**, 112, 4469

79-0165	Gold 1% on titanium dioxide extrudates (AUROLite™ Au/TiO₂) (7440-57-5)	10g
	dark purple/gray extrudates 1.5mm dia. x 5mm (avg)	50g

Technical Note:

- Useful product for the catalytic oxidation of a variety of substrates including carbon monoxide, aldehydes, alkenes, methane and ethanol. Average gold crystallite size is ~2-3nm.

Analysis: Au 1 wt% ± 0.1%; TiO₂ 98 wt%; Na+, Cl- <1500ppm**Bulk density:** 0.85–0.95 g/ml

References:

- J. Catal.*, **2007**, 252, 119
- J. Catal.*, **2008**, 260, 86
- Green Chem.*, **2008**, 10, 168
- Gold Bulletin*, **2008**, 41, 296
- Appl. Catal. B.*, **2013**, 132, 195
- Chem. Rev.*, **2012**, 112, 4469

NANOMATERIALS - GOLD (Elemental Forms)**Gold AUROLite™ Heterogeneous Catalysts***(store cold)*

Note: Sold in collaboration with Project AuTEK for research purposes. Reverse engineering and product modification prohibited. Only open before use, store cold in dark. See web for more details.

79-0170	Gold 1% on zinc oxide granulate (AUROLite™ Au/ZnO) (7440-57-5) dark purple granulate 1-2mm dia. Note: PCT WO2005115612.	10g 50g
----------------	--	------------

Technical Note:

- Useful product for the catalytic oxidation of a variety of substrates including carbon monoxide, aldehydes, alkenes, methane and ethanol. Average gold crystallite size is ~2-3nm.

Analysis: Au 1 wt% ± 0.1%; ZnO 88 wt% (contains Al₂O₃); Na+, Cl- <1500ppm

Bulk density: 1-1.2 g/ml

References:

- J.Catal.*, **2007**, 252, 119
- J.Catal.*, **2008**, 260, 86
- Green Chem.*, **2008**, 10, 168
- Gold Bulletin*, **2008**, 41, 296
- Appl. Catal. B.*, **2013**, 132, 195
- Chem. Rev.*, **2012**, 112, 4469

Gold - Colloid

Note: Made to order. Long term shelf life not established.

79-0080	Gold/tetra-n-octylammonium chloride colloid (7440-57-5) Au/(C ₈ H ₁₇) ₄ NCl; 2.6 nm ±1.1 nm; brown-orange solid <i>(store cold)</i>	250mg 1g
----------------	--	-------------

Technical Note:

- Soluble in toluene. Precursor for CO-oxidation catalysts.

Gold Nanochain

79-0134	Gold Nanochain [AuNP-Chain: 1-2 µm (Gum Arabic)] (7440-57-5) maroon-red liq. <i>(store cold)</i>	25ml
----------------	---	------

Properties: Water soluble, stable at pH 7.0; **Chain length:**1-2 µm; **Shape:** Chain; **UV-Vis (nm):**760 nm; **Stability:** Stable for 90 days; Size: 7 ±3nm

Ordering Specifications: Minimum 2 weeks required to process the order.

Supplied in aqueous solutions. Contains gum arabic stabilizer. Suitable for spin coating, self-assembly and monolayer formation. Sensor design, nanoelectronics and MEMS applications.

Gold Nanoparticles - Solid and Functionalized

79-0235	Gold nanoparticles powder, 6nm, organic solvent-dispersible (7440-57-5) black pwdr. Note: 79-0235 is an organic soluble solid. The surface ligand is dodecanethiol. The hydrodynamic size of the nanoparticles is about 8-10nm larger than their inorganic core size measured by TEM.	5mg 25mg
----------------	--	-------------

79-0238	Gold nanoparticles with amine surface functional group, 6nm, in water (7440-57-5) dark red liq. Note: 79-0238 is a group of water-soluble gold nanoparticles with amphiphilic polymer and PEG coating. The reactive group is an amine.	5mg 25mg
----------------	---	-------------

Technical Notes:

- Zeta potential of 79-0238 is from -10mV to 0 mV.
- Total thickness of organic layers is ~6 nm.
- The organic layers consist of a monolayer of dodecanethiol, a monolayer of amphiphilic polymer and a monolayer of PEG.
- The hydrodynamic size of the nanocrystals is about 12-14 nm larger than their inorganic core size as measured by TEM.
- 79-0238 is very stable in buffer solutions in the pH range of 4-10 and can survive the autoclaving (121°C for 30 mins.).
- The long term stability is not as good as that of 79-0240.
- Check expiration date before conjugating.
- 79-0238 can be conjugated to carbonyl or thiol-containing molecules.

NANOMATERIALS - GOLD (Elemental Forms)**Gold Nanoparticles - Solid and Functionalized**

79-0240	Gold nanoparticles with carboxylic acid surface functional group, 6nm, in water (7440-57-5) dark red liq. Note: 79-0240 is a group of water-soluble gold nanoparticles with amphiphilic polymer. The reactive group is a carboxylic acid.	10mg 50mg
----------------	--	--------------

Technical Notes:

1. Zeta potential is from -30mV to -50 mV.
2. Total thickness of organic layers is ~4 nm.
3. The organic layers consist of a monolayer of dodecanethiol and a monolayer of amphiphilic polymer.
4. The hydrodynamic size of the nanoparticles is about 8-10 nm larger than their inorganic core size as measured by TEM.
5. 79-0240 is very stable in buffer solutions in the pH range of 4-10 and can survive the autoclaving (121°C for 30 min.)
6. 79-0240 can be conjugated to protein, peptide, and other amine-containing molecules.

Gold Nanoparticles - Reactant Free

>99% free of residual reactant in 0.1mM phosphate buffer.

Store away from direct sunlight at 4°C. Do not freeze. Shelf life 6 months.

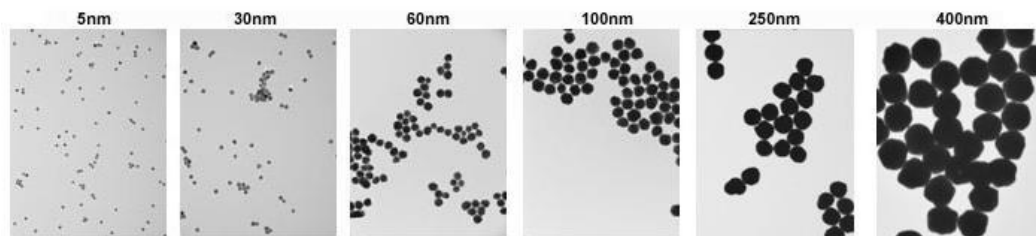
light sensitive; (store cold)**Gold Nanoparticles (1 OD, stabilized suspension in phosphate-buffered saline) reactant free (7440-57-5) (store cold)**25ml
100ml

Catalog #	Diameter	Color and form	Absorption max.
79-0180*	5nm	red liq.	515-520nm
79-0184*	10nm	red liq.	520nm
79-0186*	15nm	red liq.	520nm
79-0188*	20nm	red liq.	524nm
79-0190*	30nm	red liq.	526nm
79-0192*	40nm	red liq.	530nm
79-0194	50nm	red liq.	535nm
79-0196	60nm	pink to bright-red liq.	539nm
79-0198	80nm	pink to bright-red liq.	
79-0202	80nm	pink to bright-red liq.	
79-0204	90nm	pink to bright-red liq.	
79-0206	100nm	pink to bright-red liq.	
79-0208	150nm	pink to bright-red liq.	
79-0220	200nm	pink to bright-red liq.	
79-0222	250nm	pink to bright-red liq.	
79-0224	300nm	pink to bright-red liq.	
79-0228	400nm	pink to bright-red liq.	

*Gold Nanoparticles Kit, Reactant Free component. See page 535

96-1545	Gold Nanoparticles Kit, Reactant-Free (5nm-40nm diameter, OD 1, suspension in phosphate-buffered saline, 515-530nm abs. max.) (7440-57-5) See page 535
----------------	--

NANOMATERIALS - GOLD (Elemental Forms)**Gold Nanoparticles - Stabilizing Surfactant (1 OD, supplied in 0.1mM stabilizing surfactant)**

Store away from direct sunlight at 4°C. Do not freeze. Shelf life 6 months.

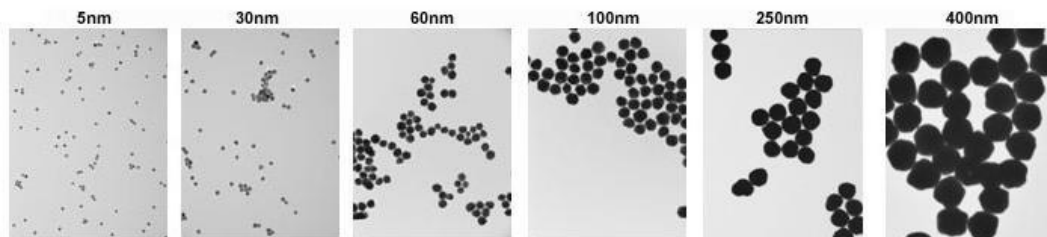
light sensitive, (store cold)**Gold Nanoparticles (1 OD, supplied in 0.1mM stabilizing surfactant) (7440-57-5)***(store cold)*

25ml

100ml

Catalog #	Diameter	Color and form	Absorption max.
79-0182	5nm	red liq.	515-520nm
79-0210	10nm	red liq.	515-520nm
79-0212	15nm	red liq.	520nm
79-0214	20nm	red liq.	524nm
79-0216	30nm	red liq.	526nm
79-0218	40nm	red liq.	530nm
79-0260	50nm	pink to bright-red liq.	535nm
79-0262	60nm	pink to bright-red liq.	540nm
79-0264	70nm	pink to bright-red liq.	548nm
79-0266	80nm	pink to bright-red liq.	553nm
79-0268	90nm	pink to bright-red liq.	564nm
79-0270	100nm	pink to bright-red liq.	572nm
79-0272	150nm	pink to bright-red liq.	
79-0274	200nm	pink to bright-red liq.	
79-0276	250nm	pink to bright-red liq.	
79-0278	300nm	pink to bright-red liq.	
79-0280	400nm	pink to bright-red liq.	

*Gold Nanoparticles Kit, stabilized suspension citrate buffer component. See <d=Anchor 4A7132

96-1547 Gold Nanoparticles Kit (5nm-40nm diameter, OD 1, stabilized suspension citrate buffer) (7440-57-5)
See page 534

NANOMATERIALS - GOLD (Elemental Forms)**Gold Nanoparticles - Spherical**Concentration: 0.03mg/ml ($\pm 10\%$)Storage Conditions: (*store cold*), store at -4°C (do not freeze)

Shelf Life: 6 months

79-6040	Spherical Gold Nanoparticles (30 nm) (7440-57-5) orange pink liq. Note: Spherical Gold Nanoparticles Kit component.	5ml 25ml
79-6045	Spherical Gold Nanoparticles (50 nm) (7440-57-5) pink liq. Note: Spherical Gold Nanoparticles Kit component.	5ml 25ml
79-6050	Spherical Gold Nanoparticles (70 nm) (7440-57-5) pink liq. Note: Spherical Gold Nanoparticles Kit component.	5ml 25ml
79-6055	Spherical Gold Nanoparticles (90 nm) (7440-57-5) violet liq. Note: Spherical Gold Nanoparticles Kit component.	5ml 25ml
96-1540	Gold Nanospheres Kit (30-90 nm) (7440-57-5) See page 535	

Gold Nanoparticles - Sugar Coated

79-0124	Sugar Coated Gold Nanoparticles [AuNP: 1-2 nm (Lactose)] (7440-57-5) maroon-red liq. (<i>store cold</i>)	5ml
---------	---	-----

Properties: Water soluble; **Size:** 22-38, 4-16, 6-10 or 1-2 nm; **Shape:** Sphere; **UV-Vis (nm):** 535, 535, 540 or 540 nm;
Stability: After generation from kit components - Stable for 1 day.
 Supplied as kit. Suitable for in vitro use and sensor design applications.

79-0122	Sugar Coated Gold Nanoparticles [AuNP: 6-10 nm (Maltose)] (7440-57-5) maroon-red liq. (<i>store cold</i>)	5ml
---------	--	-----

Properties: Water soluble; **Size:** 22-38, 4-16, 6-10 or 1-2 nm; **Shape:** Sphere; **UV-Vis (nm):** 535, 535, 540 or 540 nm;
Stability: After generation from kit components - Stable for 1 day.
 Supplied as kit. Suitable for in vitro use and sensor design applications.

Gold Nanoparticles - Surfactant and Reactant-Free (Pure), Manufactured via Laser Ablation

Note: Made to order. Manufactured by laser ablation. Store at room temperature (up to 25°C). Do not freeze. Shelf life 12 months. Sold in collaboration with Particular® for research purposes only.

79-0412 HAZ	Gold nanoparticles, pure, (<20nm) in acetone at 100mg/L (surfactant and reactant-free) (7440-57-5) red liq.	25ml 100ml
79-0416 HAZ	Gold nanoparticles, pure, (<20nm) in isopropanol at 100mg/L (surfactant and reactant-free) (7440-57-5) red liq.	25ml 100ml
79-0426 HAZ	Gold nanoparticles, pure, (50-70nm) in isopropanol at 100mg/L (surfactant and reactant-free) (7440-57-5) red liq. Note: Particle size of 50-70 nm is measured via DLS, colloid may also contain significant fractions of smaller particles. ***Limited quantities available***	25ml 100ml
79-0410	Gold nanoparticles, pure, (<20nm) in water at 100mg/L (surfactant and reactant-free, OD>1, stabilized with < 0.01 mmol/l of citrate) (7440-57-5) red liq.	25ml 100ml
79-0418	Gold nanoparticles, pure, (<20nm) in water at 500mg/L (surfactant and reactant-free, OD>5, stabilized with < 0.01 mmol/l of citrate) (7440-57-5) dark red liq.	25ml 100ml

NANOMATERIALS - GOLD (Elemental Forms)**Gold Nanoparticles - Surfactant and Reactant-Free (Supported), Manufactured via Laser Ablation**

(7440-57-5), (store cold)

Note: Manufactured by laser ablation. Sold in collaboration with Particular® for research purposes only.

79-0921	Gold nanoparticles, 1% on carbon black (surfactant and reactant-free) (7440-57-5) See page 70	
79-0916	Gold nanoparticles, 1% on Titania (anatase) (surfactant and reactant-free) (7440-57-5) See page 70	
79-0905	Gold nanoparticles, 1% on Titania (rutile) (surfactant and reactant-free) (7440-57-5) See page 70	
79-0926	Gold nanoparticles, 5% on carbon black (surfactant and reactant-free) (7440-57-5) See page 70	
79-0935	Gold nanoparticles, 10% on Titania (anatase) (surfactant and reactant-free) (7440-57-5) See page 70	
79-0930	Gold nanoparticles, 10% on Titania (rutile) (surfactant and reactant-free) (7440-57-5) See page 71	

Gold Nanoparticles - Water Soluble

(store cold)

79-0110	Water Soluble Gold Nanoparticles [AuNP: 3nm (Citrate)] (7440-57-5) wine-red liq.	25ml 100ml
Properties: Water soluble; Size: 3 nm, 5 nm, 10 or 15 nm; Shape: Sphere; UV-Vis (nm): 520, 525, 520 or 525 nm; Stability: Stable for 90 days in aqueous media. Supplied in aqueous solutions. Contains citrate stabilizer. Suitable for spin coating, self-assembly and monolayer formation.		
79-0112	Water Soluble Gold Nanoparticles [AuNP: 5nm (Citrate)] (7440-57-5) wine-red liq.	25ml 100ml
Properties: Water soluble; Size: 3 nm, 5 nm, 10 or 15 nm; Shape: Sphere; UV-Vis (nm): 520, 525, 520 or 525 nm; Stability: Stable for 90 days in aqueous media. Supplied in aqueous solutions. Contains citrate stabilizer. Suitable for spin coating, self-assembly and monolayer formation.		
79-0114	Water Soluble Gold Nanoparticles [AuNP: 10 nm (Citrate)] (7440-57-5) wine-red liq.	25ml 100ml
Technical Note: 1. See 79-0110 (page 155)		
79-0116	Water soluble Gold Nanoparticles [AuNP: 15 nm (Citrate)] (7440-57-5) wine-red liq.	25ml 100ml
Technical Note: 1. See 79-0110 (page 155)		
79-0126	Water Soluble Gold Nanoparticles [AuNP: 11-20 nm (Gelatin)] (7440-57-5) wine-red liq.	25ml 100ml
Properties: Water soluble; Size: 11-20 nm; Shape: Sphere; UV-Vis (nm): 540 nm; Stability: Stable for 90 days in aqueous media. Suitable for spin coating, self-assembly and monolayer formation. Suitable for in vitro use and sensor design applications.		
79-0108	Water Soluble Gold Nanoparticles [AuNP: 12-16 nm (Starch)] (7440-57-5) maroon-red liq.	25ml 100ml

Properties: Water soluble, stable at pH 7.0; **Size:** 30-40 nm; **Shape:** Sphere; **UV-Vis (nm):** 535 nm; **Stability:** Stable for 30 days in aqueous media.

Supplied in aqueous solutions. Contains starch stabilizer. Suitable for spin coating, self-assembly and monolayer formation.

References:

1. *Appl. Phys. Lett.*, **2006**, *88*, 153114
2. *J. Am. Chem. Soc.*, **2006**, *128*, 11342

NANOMATERIALS - GOLD (Elemental Forms)**Gold Nanorods**

79-0136 Gold Nanorods [AuNP-Rod: Aspect Ratio: 3-3.5 (CTAB)] (7440-57-5) 5ml
maroon-red liq.
(store cold)

Properties: Water soluble; **Aspect Ratio:** 3-3.5; **Shape:** Rod; **UV-Vis (nm):** 680 nm; **Stability:** Stable for 14 days
Supplied in aqueous solutions. Contains CTAB stabilizer. Ready for biomolecule conjugation. Suitable for in vitro use and sensor design applications.

Gold Nanorods (Axial Diameter - 25nm) (7440-57-5) 5ml
Storage Conditions: (store cold) Store at 4°C. Do not freeze. Shelf Life: 6 months 25ml

Catalog #	79-6000	79-6005	79-6010	79-6015
Concentration	171 ug/ml (±10%)	235 ug/ml (±10%)	150 ug/ml (±10%)	91 ug/ml (±10%)
Axial diameter (nm)	25 (±10%)	25 (±10%)	25 (±10%)	25 (±10%)
Longitudinal Size (nm)	34 (±10%)	47 (±10%)	60 (±10%)	73 (±10%)
Peak Longitudinal Surface Plasmon Resonance Wavelength (nm)	550	600	650	700
Peak Axial Surface Plasmon Resonance Wavelength (nm)	530	530	530	530
Color and Form	red liq.	blue liq.	blue liq.	gray liq.

79-6000 Gold Nanorods (Axial Diameter - 25 nm) (Wavelength 550 nm) (7440-57-5)

79-6005 Gold Nanorods (Axial Diameter - 25 nm) (Wavelength 600 nm) (7440-57-5)

79-6010 Gold Nanorods (Axial Diameter - 25 nm) (Wavelength 650 nm) (7440-57-5)

79-6015 Gold Nanorods (Axial Diameter - 25 nm) (Wavelength 700 nm) (7440-57-5)

96-1530 Gold Nanorods Kit (Axial Diameter - 25 nm, wavelength 550-700 nm) (7440-57-5)
See page 535

Gold Nanorods (Axial Diameter - 10nm) (7440-57-5) 5ml
Storage Conditions: (store cold) Store at 4°C. Do not freeze. Shelf Life: 6 months 25ml

Catalog #	79-6020	79-6025	79-6030	79-6035
Concentration	30 ug/ml (±10%)	34 ug/ml (±10%)	35 ug/ml (±10%)	36 ug/ml (±10%)
Axial diameter (nm)	10 (±10%)	10 (±10%)	10 (±10%)	10 (±10%)
Longitudinal Size (nm)	29 (±10%)	35 (±10%)	38 (±10%)	41 (±10%)
Peak Longitudinal Surface Plasmon Resonance Wavelength (nm)	700	750	780	808
Peak Axial Surface Plasmon Resonance Wavelength (nm)	512	512	512	512
Color and Form	pale red-brown liq.	pale red liq.	pale red solution	pale red liq.

79-6020 Gold Nanorods (Axial Diameter - 10 nm) (Wavelength 700 nm) (7440-57-5)

79-6025 Gold Nanorods (Axial Diameter - 10 nm) (Wavelength 750 nm) (7440-57-5)

79-6030 Gold Nanorods (Axial Diameter - 10 nm) (Wavelength 780 nm) (7440-57-5)

79-6035 Gold Nanorods (Axial Diameter - 10 nm) (Wavelength 808 nm) (7440-57-5)

96-1535 Gold Nanorods Kit (Axial Diameter - 10 nm, wavelength 700-808 nm) (7440-57-5)
See page 535

NANOMATERIALS - GOLD (Elemental Forms)**Gold Nanorods, CTAB Free***light sensitive, (store cold)*

Note: Rods are synthesized without CTAB. Store at 4°C - 8°C. Do not freeze. At storage temperature the product may appear opaque. Follow the procedure for re-dispersing surfactants as described in the technical note. Complete this process before use to dissolve precipitated stabilizer. Sold in Collaboration with SONA Nanotech for research purposes only. Gold Gemini Nanorods Kit component.

79-7010 Gold Gemini Nanorods, CTAB Free (Wavelength 650 nm) (7440-57-5)5ml
25ml**NEW**

Au; violet liq.

Technical Note:

Item #	LPSR Maximum (nm)	Length (nm)	Width (nm)	Aspect Ratio	Color & Form
79-7010	640 - 670	25 - 31	13 - 18	1.7 - 1.9	violet liq.
79-7015	685 - 715	37 - 43	13 - 18	2.4 - 2.8	blue liq.
79-7020	735 - 765	37 - 44	10 - 13	3.4 - 3.7	red-purple liq.
79-7025	785 - 815	40 - 50	10 - 13	3.8 - 4.1	red-orange liq.
79-7030	835 - 865	48 - 55	9 - 12	4.6 - 5.3	maroon-purple liq.

Concentration: >30 µg/ml
pH: 5.5 - 7.5
Stabilizer: Amphiphilic Agents
Solvent: Stabilized with amphiphilic agents in conductivity grade water (18.0 MΩ cm⁻¹)
Optical Density: 1.0 - 1.2
Shelf Life: 12 months

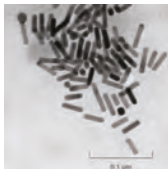
79-7015 Gold Gemini Nanorods, CTAB Free (Wavelength 700 nm) (7440-57-5)5ml
25ml**NEW**

Au; blue liq.

Technical Note:

1. See 79-7010 (page 157)

79-7020 Gold Gemini Nanorods, CTAB Free (Wavelength 750 nm) (7440-57-5)5ml
25ml**NEW**

Au; red-purple liq.

Technical Note:

1. See 79-7010 (page 157)

79-7025 Gold Gemini Nanorods, CTAB Free (Wavelength 800 nm) (7440-57-5)5ml
25ml**NEW**

Au; red-orange liq.

Technical Note:

1. See 79-7010 (page 157)

79-7030 Gold Gemini Nanorods, CTAB Free (Wavelength 850 nm) (7440-57-5)5ml
25ml**NEW**

Au; maroon-purple liq.

Technical Note:

1. See 79-7010 (page 157)

96-1549 Gold Gemini Nanorods Kit, CTAB Free (Wavelength 650-850 nm)

See page 534

NANOMATERIALS - GOLD (Elemental Forms)**Gold NanoUrchins (1 OD, 0.1 mM in phosphate-buffered saline) >95.0% reactant free**20ml
100ml

blue liq.

light sensitive, (store cold)

Note: Store away from direct sunlight at 4°C. Do not freeze.

Shelf life 6 months.

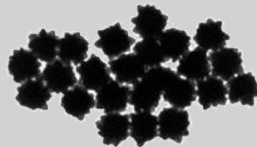

Product #	Diameter	Color and form	Absorption max
79-0310	50nm	blue liq.	585nm
79-0313	60nm	blue liq.	585nm
79-0315	70nm	blue liq.	600nm
79-0318	80nm	blue liq.	620nm
79-0320	90nm	blue liq.	630nm
79-0323	100nm	blue liq.	680nm

NANOMATERIALS - GOLD (Compounds)

79-2015	Diphenyl(m-sulfonatophenyl)phosphine-gold nanocluster (water soluble) (1-3 nm) dark red solid; particle size: 1-3 nm Note: Made to order. Long term shelf life not established.	100mg 500mg
79-2035	Hexachlorododecakis[diphenyl(m-sulfonatophenyl)phosphine]pentapentacontagold, dodecasodium salt (water soluble) Schmid Au₅₅ Cluster (115804-59-6) Na ₁₂ {Au ₅₅ [P(C ₆ H ₅) ₂ (C ₆ H ₄ SO ₃) ₁₂ Cl ₆]}; FW: 15417.85; black solid	10mg
79-2030	Hexachlorododecakis(triphenylphosphine)pentapentacontagold Schmid Au₅₅ Cluster (104619-10-5) A ₅₅ [P(C ₆ H ₅) ₃] ₁₂ Cl ₆ ; FW: 14193.30; black solid	10mg 50mg

NANOMATERIALS - IRIIDIUM (Compounds)**Antimony Tin Oxide/Iridium Het-WOC core/shell nanopowder (conductive and acid-stable)**blue powdr.; ATO Composition: 90% SnO₂, 10% Sb₂O₃ (w/w)50g
250g

Note: Sold under license from Catalytic Innovations, LLC for research purposes only. US Patent Publication No. US20150021194 A1.

Product #	Particle Size	BET Surface Area	Resistivity
77-0030	20nm	50 - 60m ² /g	0.3 - 0.7 Ω·cm See page 85
77-0035	50nm	40 - 50m ² /g	0.05 - 0.08 Ω·cm See page 85
77-0040	100nm	5 - 10m ² /g	0.05 - 0.08 Ω·cm See page 85

NANOMATERIALS - IRON (Compounds)**Iron Magnetic Fluids**

26-0032	Iron(II,III) oxide (Magnetite) aqueous magnetic fluid [3.5 vol%, Ms = 15-16 kA/m] (1317-61-9) Fe ₃ O ₄ ; black solid (water suspension)	2ml 10ml
26-0036	Iron(II,III) oxide (Magnetite) aqueous magnetic fluid [7.0 vol%, Ms = 30-31 kA/m] (1317-61-9) Fe ₃ O ₄ ; black solid (water suspension)	2ml 10ml
26-0022 HAZ	Iron(II,III) oxide (Magnetite) magnetic fluid in kerosene with oleic acid [7-9 vol%, Ms = 35-45 kA/m] (1317-61-9) black, viscous liq.	2ml 10ml
26-0024 HAZ	Iron(II,III) oxide (Magnetite) magnetic fluid in kerosene with oleic acid [15-18 vol%, Ms = 50-70 kA/m] (1317-61-9) black, viscous liq.	2ml 10ml

NANOMATERIALS - IRON (Compounds)**Iron Nanoparticles**

Note: Store at 5 to 25°C. Do not freeze. Suggested use within 12 months of receipt. Sold in collaboration with Cerion for research purposes only.

26-2758	Iron(III) oxyhydroxide in water at pH = 3.0 +/- 0.5 (FEO-W320) (20344-49-4)	25g
HAZ	FeO(OH); FW: 88.85; d. 1.19 (store cold)	100g 500g

% Solids: 20.0 +/- 0.5 as Fe₂O₃

pH: 3.0 +/- 0.5

Mean Number Weighted Particle Diameter: <5.0 nm (by Dynamic Light Scattering)

Polydispersity Index: <0.25

Chemical Composition (particles): >99.5% FeOOH

Iron Nanoparticles - Solid form (with amine surface functional group)

Note: A water-soluble iron oxide nanoparticles with amphiphilic polymer and PEG coating. The reactive group is an amine.

26-2711	Iron oxide nanoparticles in water, 10nm, with amine surface functional group (1309-37-1); brown liq.	5mg 25mg
----------------	---	-------------

Technical Notes:

1. Zeta potential is -10mv to +10mV.
2. The organic layers consist of a monolayer of oleic acid and a monolayer of amphiphilic polymer.
3. The overall thickness of the organic layers about 6 nm.
4. The hydrodynamic size of the nanoparticles is about 12-14 nm larger than their inorganic core size measured by TEM.
5. Very stable in most buffer solutions in the pH range of 4-10. Solution can survive autoclaving process (121°C for 30 minutes).
6. Light precipitation may occur during storage. Check expiration date before conjugation.
7. The amine density is low due to the long PEG chain.
8. Can be conjugated to carbonyl or thio-containing molecules.

References:

1. *Clinical Cancer Research*, **2009**, 15, 4722
2. *Gastroenterology*, **2009**, 136, 1514
3. *Small*, **2009**, 5, 235
4. *The Analysis*, **2008**, 133, 154
5. *The Journal of Physical Chemistry C*, **2008**, 112, 8127
6. *International Journal of Nanomedicine*, **2008**, 3, 311
7. *Journal of Biomedical Nanotechnology*, **2008**, 4, 439

26-2713	Iron oxide nanoparticles in water, 20nm, with amine surface functional group (1309-37-1); black liq.	5mg 25mg
----------------	---	-------------

Technical Note:

1. See 26-2711 (page 159)

26-2715	Iron oxide nanoparticles in water, 30nm, with amine surface functional group (1309-37-1); black liq.	5mg 25mg
----------------	---	-------------

Technical Note:

1. See 26-2711 (page 159)

Iron Nanoparticles - Solid form (with carboxylic acid surface functional group)

Note: A water-soluble iron oxide nanoparticles with amphiphilic polymer coating. The reactive group is a carboxylic acid.

26-2705	Iron oxide nanoparticles in water, 10nm, with carboxylic acid surface functional group (1309-37-1) brown liq.	10mg 50mg
----------------	--	--------------

Technical Notes:

1. Zeta potential of 26-2705 -30mv to -50mV.
2. The organic layers consist of a monolayer of oleic acid and a monolayer of amphiphilic polymer.
3. The overall thickness of the organic layers about 4 nm.
4. The hydrodynamic size of the nanoparticles is about 8-10 nm, larger than their inorganic core size measured by TEM.
5. Very stable in most buffer solutions in the pH range of 4-10. Solution can survive autoclaving process (121°C for 30 minutes).

References:

1. *Clinical Cancer Research*, **2009**, 15, 4722
2. *Gastroenterology*, **2009**, 136, 1514
3. *Small*, **2009**, 5, 235
4. *The Analysis*, **2008**, 133, 154
5. *The Journal of Physical Chemistry C*, **2008**, 112, 8127
6. *International Journal of Nanomedicine*, **2008**, 3, 311
7. *Journal of Biomedical Nanotechnology*, **2008**, 4, 439

NANOMATERIALS - IRON (Compounds)**Iron Nanoparticles - Solid form (with carboxylic acid surface functional group)**

Note: A water-soluble iron oxide nanoparticles with amphiphilic polymer coating. The reactive group is a carboxylic acid.

26-2707	Iron oxide nanoparticles in water, 20nm, with carboxylic acid surface functional group (1309-37-1) black liq.	10mg 50mg
----------------	--	--------------

Technical Note:

1. See 26-2705 (page 159)

26-2709	Iron oxide nanoparticles in water, 30nm, with carboxylic acid surface functional group (1309-37-1) black liq.	10mg 50mg
----------------	--	--------------

Technical Note:

1. See 26-2705 (page 159)

Iron Nanoparticles - Solid form (organic solvent-dispersible)

Note: A water-soluble iron oxide nanoparticles with amphiphilic polymer and PEG coating. No linkable reactive group on the surface.

26-2728	Iron oxide nanoparticles, 10nm, organic solvent-dispersible (in chloroform) (1309-37-1) brown liq.	50mg 500mg
----------------	---	---------------

Technical Notes:

1. Zeta potential is -10mv to 0.
2. Total thickness of organic layers is ~6 nm.
3. The hydrodynamic size of the nanoparticles is about 12-14 nm larger than their inorganic core size as measured by TEM.
4. The colloidal stability is exceptionally high.
5. Stable in most buffer solutions in the pH range of 4-10. Solution can survive autoclaving process (121°C for 30 minutes).

References:

1. *Clinical Cancer Research*, **2009**, 15, 4722
2. *Gastroenterology*, **2009**, 136, 1514
3. *Small*, **2009**, 5, 235
4. *The Analysis*, **2008**, 133, 154
5. *The Journal of Physical Chemistry C*, **2008**, 112, 8127
6. *International Journal of Nanomedicine*, **2008**, 3, 311
7. *Journal of Biomedical Nanotechnology*, **2008**, 4, 439

26-2730	Iron oxide nanoparticles, 20nm, organic solvent-dispersible (in chloroform) (1309-37-1) black liq.	50mg 500mg
----------------	---	---------------

Technical Note:

1. See 26-2728 (page 160)

26-2732	Iron oxide nanoparticles, 30nm, organic solvent-dispersible (in chloroform) (1309-37-1) black liq.	50mg 500mg
----------------	---	---------------

Technical Note:

1. See 26-2728 (page 160)

Iron Nanoparticles - Solid form (in water with PEG)

Note: A water-soluble iron oxide nanoparticles with amphiphilic polymer and PEG coating. No linkable reactive group on the surface.

26-2722	Iron oxide nanoparticles in water, 10nm, with PEG (1309-37-1) brown liq.	5mg 25mg
----------------	--	-------------

Technical Notes:

1. Zeta potential is -10mv to 0.
2. Total thickness of organic layers is ~6 nm.
3. The hydrodynamic size of the nanoparticles is about 12-14nm larger than their inorganic core size as measured by TEM.
4. The colloidal stability is exceptionally high.
5. Stable in most buffer solutions in the pH range of 4-10. Solution can survive autoclaving process (121°C for 30 minutes).

References:

1. *Clinical Cancer Research*, **2009**, 15, 4722
2. *Gastroenterology*, **2009**, 136, 1514
3. *Small*, **2009**, 5, 235
4. *The Analysis*, **2008**, 133, 154
5. *The Journal of Physical Chemistry C*, **2008**, 112, 8127
6. *International Journal of Nanomedicine*, **2008**, 3, 311
7. *Journal of Biomedical Nanotechnology*, **2008**, 4, 439

NANOMATERIALS - IRON (Compounds)**Iron Nanoparticles - Solid form (in water with PEG)**

Note: A water-soluble iron oxide nanoparticles with amphiphilic polymer and PEG coating. No linkable reactive group on the surface.

26-2724	Iron oxide nanoparticles in water, 20nm, with PEG (1309-37-1)	5mg 25mg
black liq.		
Technical Note:		
1. See 26-2722 (page 160)		
26-2726	Iron oxide nanoparticles in water, 30nm, with PEG (1309-37-1)	5mg 25mg
black liq.		
Technical Note:		
1. See 26-2722 (page 160)		

NANOMATERIALS - LEAD (Compounds)**Lead Sulfide Quantum Dots**



Note: Sold in collaboration with CAN for R&D purposes. Suggest use within 6 months of purchase. Do not freeze. Store in DARK.

82-1081	Lead sulfide CANdot® quantum dot (PbS core - ~3nm), 10 mg/mL in toluene,	2ml
HAZ	1000nm peak emission (1314-87-0)	10ml
PbS; FW: 239.25; dark-red liq.		
82-1083	Lead sulfide CANdot® quantum dot (PbS core - ~4.5nm), 10 mg/mL in toluene,	1ml
HAZ	1200nm peak emission (1314-87-0)	5ml
PbS; FW: 239.25; dark-red liq.		
82-1085	Lead sulfide CANdot® quantum dot (PbS core - ~6nm), 10 mg/mL in toluene,	1ml
HAZ	1400nm peak emission (1314-87-0)	5ml
PbS; FW: 239.25; dark-red liq.		
82-1090	Lead sulfide CANdot® quantum dot (PbS core - ~8nm), 10 mg/mL in toluene,	1ml
HAZ	1600nm peak emission (1314-87-0)	5ml
PbS; FW: 239.25; dark-red liq.		

NANOMATERIALS - MAGNESIUM (Compounds)

12-1405	Magnesium oxide nanopowder (1309-48-4)	25g 100g
MgO; FW: 40.31; white powdr.		
Note: APS 20nm; SSA 50m ² /g		

NANOMATERIALS - NICKEL (Elemental Forms)

28-0008	Nickel/tetra-n-octylammonium bromide colloid, purified (65-70% Ni)	100mg 500mg
HAZ	(7440-02-0)	
	Ni/(C ₈ H ₁₇) ₄ NBr; 2.8 nm (average); black powdr.	
	pyrophoric	
Note: Made to order. Suggest use within 3 months of receipt. Long term shelf life not established.		

Technical Note:

1. Soluble in THF, toluene, acetone and methylene chloride. Insoluble in ethanol, ether and pentane.

References:

1. *J. Mol. Catal.*, **1994**, *86*, 129
2. *Eur. J. Inorg. Chem.*, **2001**, 2455
3. *Catalysis and Electrocatalysis at Nanoparticles Surfaces*, Chapter 10, p, 343, 377. Marcel Dekker, NY, **2003**.
4. *Advanced Catalysts and Nanostructured Materials*, Chapter 7, Academic, Press, San Diego, **1996**, 165-196.

NANOMATERIALS - PALLADIUM (Elemental Forms)**Palladium Heterogeneous Catalyst**

46-1710	Palladium, 0.6% on activated carbon, 50% water-wet paste (NanoSelect LF 100) (7440-05-3)	
See page 223		
46-1711	Palladium, 0.5% on titanium silicate, 50% water-wet paste (NanoSelect LF 200) (7440-05-3)	
See page 225		

NANOMATERIALS - PALLADIUM (Elemental Forms)**Palladium Nanoparticles**

46-0407	Palladium Nanoparticles [PdNP: 2-4 nm (gum Arabic)] (7440-05-3) yellowish-brown liq. (store cold)	25ml 100ml
----------------	--	---------------

Properties: Water soluble; **Size:** 2-4 nm; **Shape:** Sphere; **Specification:** Stable for 60 days.

Supplied in aqueous media, contains gum arabix stabilizer. Suitable for in vitro use and sensor design applications. Suitable for spin coating, self-assembly and monolayer formation. Potential new Catalysts.

46-0409	Palladium Nanoparticles [PdNP: 2-3 nm (Gelatin)] (7440-05-3) yellowish-brown liq. (store cold)	25ml 100ml
----------------	---	---------------

Properties: Water soluble; **Size:** 2-3 nm; **Shape:** Sphere; **Specification:** Stable for 60 days.

Supplied in aqueous media, contains gelatin stabilizer. Suitable for in vitro use and sensor design applications. Suitable for spin coating, self-assembly and monolayer formation. Potential new Catalysts.

Palladium Nanoparticles - Surfactant and Reactant-Free (Pure), Manufactured via Laser Ablation

Note: Made to order. Manufactured by laser ablation. Store at room temperature (up to 25°C). Do not freeze. Shelf life 12 months. Sold in collaboration with Particular® for research purposes only.

46-4012 HAZ	Palladium nanoparticles, pure, (<20nm) in acetone at 100mg/L (surfactant and reactant-free) (7440-05-3) grey-brown liq.	25ml 100ml
-----------------------	--	---------------

46-4010	Palladium nanoparticles, pure, (<20nm) in water at 100mg/L (surfactant and reactant-free, stabilized with < 0.01 mmol/l of citrate) (7440-05-3) grey-brown liq.	25ml 100ml
----------------	---	---------------

46-4018	Palladium nanoparticles, pure, (<20nm) in water at 500mg/L (surfactant and reactant-free, stabilized with < 0.01 mmol/l of citrate) (7440-05-3) black liq.	25ml 100ml
----------------	--	---------------

46-4022 HAZ	Palladium nanoparticles, pure, (50-70nm) in acetone at 100mg/L (surfactant and reactant-free) (7440-05-3) grey liq. Note: Particle size of 50-70 nm is measured via DLS, colloid may also contain significant fractions of smaller particles. ***Limited quantities available***	25ml 100ml
-----------------------	---	---------------

NANOMATERIALS - PALLADIUM (Compounds)

28-0015	Nickel/palladium alloy nanoparticle on graphene (G-Ni₃₃Pd₆₇) See page 222
----------------	---

NANOMATERIALS - PLATINUM (Elemental Forms)**Platinum Colloids**

Note: Made to order. Suggest use within 3 months of receipt. Long term shelf life not established.

78-0055 HAZ 	Platinum/tetra-n-octylammonium chloride colloid, purified (70-85% Pt) (7440-06-4) Pt(C ₈ H ₁₇) ₄ NCl; 2.8 nm ±0.5 nm; grayish-black pwrd pyrophoric	250mg 1g
---	--	-------------

Technical Note:

1. Soluble in THF. Insoluble in toluene, acetone, ether and ethanol.

References:

1. *J. Mol. Catal.*, **1994**, *86*, 129
2. *Eur. J. Inorg. Chem.*, **2001**, 2455.
3. *Synthetic Methods of Organometallic and Inorganic Chemistry*, Vol.10, Chapter 20, p. 209-223, Thieme Verlag, NY, 2002.
4. *Catalysis and Electrocatalysis at Nanoparticles Surfaces*, Chapter 10, p. 343, 377, Marcel Dekker, NY, 2003.

78-0062 HAZ	Platinum-ruthenium/tetra-n-octylammonium chloride colloid (~7 wt% Pt, ~3.5 wt% Ru) (7440-06-4) Pt ₅₀ Ru ₅₀ (C ₈ H ₁₇) ₄ NCl; 1.7 nm ±0.5 nm; waxy, black residue	250mg 1g
-----------------------	--	-------------

Technical Note:

1. Very soluble in THF. Soluble in toluene. Precursor for fuel cell catalysts.

References:

1. *J. Mol. Catal.*, **1994**, *86*, 129
2. *Synthetic Methods of Organometallic and Inorganic Chemistry*, Vol. 10, Chapter 20, p. 209-223, Thieme Verlag, NY, 2002.
3. *Catalysis and Electrocatalysis at Nanoparticles Surfaces*, Chapter 10, p. 343-377, Marcel Dekker, NY, 2003.

NANOMATERIALS - PLATINUM (Elemental Forms)**Platinum Fuel Cell Catalysts****78-1685 Dealloyed Pt-Co core-shell fuel cell catalyst on carbon**

See page 333

78-1688 Dealloyed Pt-Cu core-shell fuel cell catalyst on carbon

See page 333

Platinum Nanoparticles

Note: Made to order. Suggest use within 3 months of receipt. Long term shelf life not established.

78-0007 Platinum, 97% (2-5 nanometers) (7440-06-4)

250mg

HAZ Pt; black powdr.

1g

pyrophoric

References:

1. *J. Mol. Catal.*, **1994**, 86, 129

78-0405 Platinum Nanoparticles [PtNP: 2-3 nm (gum Arabic)] (7440-06-4)

25ml

yellowish-brown liq.

100ml

(store cold)

Properties: Water soluble; **Size:** 2-3 nm; **Shape:** Sphere; **UV Vis (nm):**405-410 nm; **Specification:** Stable for 60 days
 Supplied in aqueous media, contains gum arabic stabilizer. Suitable for in vitro use and sensor design applications. Suitable for spin coating, self-assembly and monolayer formation. Potential new Catalysts.

Platinum Nanoparticles - Surfactant and Reactant-Free (Pure), Manufactured via Laser Ablation

Note: Manufactured by laser ablation. Store at room temperature (up to 25°C). Do not freeze. Shelf life 6 months.

Sold in collaboration with Particular® for research purposes only.

78-1405 Platinum nanoparticles, pure, (<20nm) in water at 30mg/L (surfactant and reactant-free, stabilized with <0.01 mmol/l of citrate) (7440-06-4)

100ml

grey-brown liq.

78-1402 Platinum nanoparticles, pure, (<20nm) in water at 100mg/L (surfactant and reactant-free, stabilized with < 0.01 mmol/l of citrate) (7440-06-4)

25ml

grey-brown liq.

100ml

78-1404 Platinum nanoparticles, pure, (<20nm) in acetone at 100mg/L (surfactant and reactant-free) (7440-06-4)

25ml

HAZ

grey-brown liq.

100ml

Note: Made to order. Manufactured by laser ablation. Store at room temperature (up to 25°C). Do not freeze. Shelf life 12 months. Sold in collaboration with Particular® for research purposes only.

78-1408 Platinum nanoparticles, pure, (<20nm) in isopropanol at 100mg/L (surfactant and reactant-free) (7440-06-4)

25ml

HAZ

grey-brown liq.

100ml

Note: Made to order. Manufactured by laser ablation. Store at room temperature (up to 25°C). Do not freeze. Shelf life 12 months. Sold in collaboration with Particular® for research purposes only.

78-1410 Platinum nanoparticles, pure, (<20nm) in water at 500mg/L (surfactant and reactant-free, stabilized with < 0.01 mmol/l of citrate) (7440-06-4)

25ml

black liq.

100ml

78-1414 Platinum nanoparticles, pure, (50-70nm) in acetone at 100mg/L (surfactant and reactant-free) (7440-06-4)

25ml

HAZ

grey liq.

100ml

Particle size of 50-70 nm is measured via DLS, colloid may also contain significant fractions of smaller particles. ***Limited quantities available***

78-1418 Platinum nanoparticles, pure, (50-70nm) in isopropanol at 100mg/L (surfactant and reactant-free) (7440-06-4)

25ml

HAZ

grey liq.

100ml

Particle size of 50-70 nm is measured via DLS, colloid may also contain significant fractions of smaller particles. ***Limited quantities available***

NANOMATERIALS - PLATINUM (Elemental Forms)**Platinum Nanoparticles - Surfactant and Reactant-Free (Supported), Manufactured via Laser Ablation**

Note: Manufactured by laser ablation. Store at room temperature (up to 25°C). Do not freeze. Shelf life 6 months.

Sold in collaboration with Particular® for research purposes only.

78-3015	Platinum nanoparticles, 1% on carbon black (surfactant and reactant-free) (7440-06-4) See page 335	
78-3020	Platinum nanoparticles, 5% on carbon black (surfactant and reactant-free) (7440-06-4) See page 335	
78-3030	Platinum nanoparticles, 10% on carbon black (surfactant and reactant-free) (7440-06-4) See page 335	
78-3032	Platinum nanoparticles, 20% on carbon black (surfactant and reactant-free) (7440-06-4) See page 335	
78-3035	Platinum nanoparticles, 30% on carbon black (surfactant and reactant-free) (7440-06-4) See page 335	
78-3012	Platinum nanoparticles, 1% on Titania (anatase) (surfactant and reactant-free) (7440-06-4) See page 335	
78-3005	Platinum nanoparticles, 1% on Titania (rutile) (surfactant and reactant-free) (7440-06-4) See page 336	
78-3026	Platinum nanoparticles, 10% on Titania (anatase) (surfactant and reactant-free) (7440-06-4) See page 336	
78-3023	Platinum nanoparticles, 10% on Titania (rutile) (surfactant and reactant-free) (7440-06-4) See page 336	

NANOMATERIALS - RHODIUM (Elemental Forms)**Rhodium Colloid**

Note: Made to order. Suggest use within 3 months of receipt. Long term shelf life not established.

45-1550	Rhodium colloid (polyethyleneglycol-dodecylether hydrosol) (~9 wt% Rh) (7440-16-6) Rh/alkoxyethers; ~2 nm; brown-black viscous substance Note: *Limited quantities available*	1g 5g
---------	---	----------

Technical Note:

1. Soluble in ether, alcohol, and water.

References:

1. *Eur. J. Inorg. Chem.*, **2001**, 2455

45-1660	Rhodium/tetra-n-octylammonium chloride colloid, purified (70-75% Rh) (7440-16-6) Rh/(C ₈ H ₁₇) ₄ NCl; 2.0 nm ±0.5 nm; gray pwdr <i>pyrophoric</i> Note: Made to order. Suggest use within 3 months of receipt. Long term shelf life not established.	250mg 1g
---------	---	-------------

Technical Note:

1. Very soluble in THF, soluble in acetone, slightly soluble in toluene, insoluble in ether.

References:

1. *J. Mol. Catal.*, **1994**, 86, 129
2. *Eur. J. Inorg. Chem.*, **2001**, 2455
3. *Catalysis and Electrocatalysis at Nanoparticles Surfaces, Chapter 10*, p. 343, 377. Marcel Dekker, NY, **2003**.
4. *Advanced Catalysts and Nanostructured Materials, Chapter 7*, Academic, Press, San Diego, **1996**, 165-196.

NANOMATERIALS - RHODIUM (Elemental Forms)**Rhodium Nanoparticles - Surfactant and Reactant-Free (Pure), Manufactured via Laser Ablation**

Note: Made to order. Manufactured by laser ablation. Store at room temperature (up to 25°C). Do not freeze. Shelf life 12 months. Sold in collaboration with Particular® for research purposes only.

45-1324 HAZ	Rhodium nanoparticles, pure, (<20nm) in acetone at 100mg/L (surfactant and reactant-free) (7440-16-6) grey-brown liq.	25ml 100ml
45-1328 HAZ	Rhodium nanoparticles, pure, (<20nm) in isopropanol at 100mg/L (surfactant and reactant-free) (7440-16-6) grey-brown liq.	25ml 100ml
45-1322	Rhodium nanoparticles, pure, (<20nm) in water at 100mg/L (surfactant and reactant-free, stabilized with < 0.01 mmol/l of citrate) (7440-16-6) grey-brown liq.	25ml 100ml
45-1330	Rhodium nanoparticles, pure, (<20nm) in water at 500mg/L (surfactant and reactant-free, stabilized with < 0.01 mmol/l of citrate) (7440-16-6) black liq.	25ml 100ml

NANOMATERIALS - RUTHENIUM (Elemental Forms)**Ruthenium Nanoparticles - Surfactant and Reactant-Free (Pure), Manufactured via Laser Ablation**

Note: Made to order. Manufactured by laser ablation. Store at room temperature (up to 25°C). Do not freeze. Shelf life 12 months. Sold in collaboration with Particular® for research purposes only.

44-2812 HAZ	Ruthenium nanoparticles, pure, (<20nm) in acetone at 100mg/L (surfactant and reactant-free) (7440-18-8) grey-brown liq. Note: ***Limited quantities available***	25ml 100ml
44-2822 HAZ	Ruthenium nanoparticles, pure, (50-70nm) in acetone at 100mg/L (surfactant and reactant-free) (7440-18-8) grey liq. Note: Particle size of 50-70 nm is measured via DLS, colloid may also contain significant fractions of smaller particles. ***Limited quantities available***	25ml 100ml

NANOMATERIALS - SILICON (Elemental Forms)

14-0655	Silicon powder (amorphous), min. 97% (7440-21-3) See page 405	
14-0650 HAZ	Silicon powder (nanocrystalline), min. 97% (7440-21-3) Si; brown powdr.; SA: <20 m ² /g <i>air sensitive</i> For detailed technical note visit strem.com .	5g 25g
14-6052	Silica Nanosprings™ coated with zinc oxide and grown on fiber glass substrate (3.5 x 8cm) (7631-86-9) white to beige plate Note: ***Limited quantities available.***	1pc

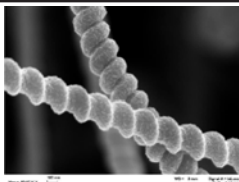

NANOMATERIALS - SILVER (Elemental Forms)**Silver Nanoparticles - Reactant-Free***light sensitive, (store cold)*

20ml

100ml

Note: Store away from direct sunlight at 4°C. Do not freeze. Shelf life 6 months.

Product #	Diameter	Color and form	Absorption max
47-0655	10nm	yellow liq.	390-400nm
47-0658	20nm	yellow liq.	405nm
47-0660	30nm	yellow liq.	410nm
47-0663	40nm	yellow liq.	416nm
47-0665	50nm	yellow liq.	425nm
47-0668	60nm	yellow liq.	430nm
47-0670	80nm	yellow liq.	457nm
47-0672	100nm	yellow liq.	490nm

Silver Nanoparticles - Surfactant and Reactant-Free (Pure), Manufactured via Laser Ablation

Note: Made to order. Manufactured by laser ablation. Store at room temperature (up to 25°C). Do not freeze. Shelf life 12 months. Sold in collaboration with Particular® for research purposes only.

47-0712 HAZ	Silver nanoparticles, pure, (<20nm) in acetone at 100mg/L (surfactant and reactant-free) (7440-22-4) yellowish-brown liq.	25ml 100ml
47-0710	Silver nanoparticles, pure, (<20nm) in water at 100mg/L (surfactant and reactant-free, stabilized with < 0.01 mmol/l of citrate) (7440-22-4) yellow liq.	25ml 100ml
47-0718	Silver nanoparticles, pure, (<20nm) in water at 500mg/L (surfactant and reactant-free, stabilized with < 0.01 mmol/l of citrate) (7440-22-4) yellowish-grey liq.	25ml 100ml
47-0722 HAZ	Silver nanoparticles, pure, (50-70nm) in acetone at 100mg/L (surfactant and reactant-free) (7440-22-4) yellowish-brown liq. Particle size of 50-70 nm is measured via DLS, colloid may also contain significant fractions of smaller particles. ***Limited quantities available***	25ml 100ml

Silver Nanoporous Catalyst

47-0645 NEW HAZ	Silver Nano-Porous Catalyst (promoted with zirconium oxide) Ag; grey powdr. Note: Sold under license from OXENERGY for research purposes only. US Patent No 8,142,938. For detailed technical note visit strem.com .	1g 5g 25g
------------------------------	---	-----------------

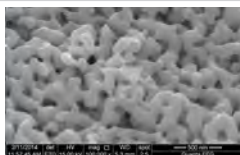
**Specifications:**Average cluster (particle) size, micron:12-17; Average cluster porosity, %:38-42; Average pore size, nm: 30-50; Specific surface area, m²/g: 6.0-7.0; Apparent density, g/ml: 0.9-1.1**NANOMATERIALS - TIN (Compounds)**

50-0518 NEW	Tin(IV) oxide, nanoparticle (30-60 nm), (99.7%-Sn) (18282-10-5) SnO ₂ ; FW: 150.69; white powdr.; SA: 18.55 m ² /g; m.p. 1630°; d. 6.95	25g 100g
-----------------------	---	-------------

NANOMATERIALS - TITANIUM (Elemental Forms)**Titanium Nanoparticles - Surfactant and Reactant-Free (Pure), Manufactured via Laser Ablation**

Note: Made to order. Manufactured by laser ablation. Store at room temperature (up to 25°C). Do not freeze. Shelf life 12 months. Sold in collaboration with Particular® for research purposes only.

22-0192 HAZ	Titanium nanoparticles, pure, (<20nm) in acetone at 100mg/L (surfactant and reactant-free) (7440-32-6) grey liq. Note: ***Limited quantities available***	25ml 100ml
22-0198	Titanium nanoparticles, pure, (50-70nm) in ethylene glycol at 100mg/L (surfactant and reactant-free) (7440-32-6) grey liq. Note: Particle size of 50-70 nm is measured via DLS, colloid may also contain significant fractions of smaller particles. ***Limited quantities available***	25ml
22-0203 HAZ	Titanium nanoparticles, pure, (50-70nm) in isopropanol at 100 mg/L (surfactant and reactant-free) (7440-32-6) grey liq. Note: Particle size of 50-70 nm is measured via DLS, colloid may also contain significant fractions of smaller particles. ***Limited quantities available***	100ml

NANOMATERIALS - TITANIUM (Compounds)

22-1400	Titanium(IV) oxide nanopowder Anatase (1317-80-2) TiO ₂ ; FW: 79.90; white powdr.	5g 25g
---------	--	-----------

Specific Surface Area (BET): ≥500 m²/g; **True Density:** 3.7 g/cc; **Crystallite Size:** Amorphous; **Mean Aggregate Size:** 5 μm; **Average Pore Diameter:** 32Å; **Loss on Ignition:** ≤12%; **Total Pore Volume:** ≥0.4 cc/g; **Moisture Content:** ≤4%; **Bulk Density:** 0.6 g/cc; **Ti Content (Based on Metal):** > 99.999%

NANOMATERIALS - ZINC (Elemental Forms)

30-1500 HAZ	Nano Zinc Metallic Powder (7440-66-6) Zn; gray powdr.; Average particle size: 75-125 nm; Morphology: spherical; SA: 4-6 m ² /g <i>moisture sensitive</i>	1g 5g
----------------	---	----------

Technical Note:

1. Nano zinc powder is a highly reactive metal with a small particle size and high surface area. The product is exceptionally reactive with organic halides forming organozinc compounds, and in azo-coupling reactions. The nano zinc can be deagglomerized into primary nanoparticles of 35nm by sonication.

NANOMATERIALS - ZINC (Compounds)

30-1405	Zinc oxide nanopowder (1314-13-2) ZnO; FW: 81.37; white powdr.	25g 100g
---------	--	-------------

NANOMATERIALS - OTHER

96-0900	Enzymatic Flow Reactor (2.5 inch tube x 0.25 inch I.D.) See page 617
---------	--

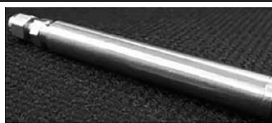
**NANOMATERIALS (Surfactants & Ligands for nano synthesis)**

07-0440	L-Cysteine ethyl ester hydrochloride, 98% (868-59-7) HSCH ₂ CH(NH ₂)COOC ₂ H ₅ ·HCl; FW: 185.67; white solid; m.p. 123-125° Note: Surfactant for nanomaterial synthesis.	25g 100g
02-5043	3-(Decyldimethylammonio)propanesulfonate (Sulfobetaine 10) (15163-36-7) [CH ₃ (CH ₂) ₉ N ⁺][(CH ₂) ₂ (CH ₂) ₃ SO ₃ ⁻]; FW: 307.49; white solid Note: Surfactant for nanomaterial synthesis.	1g 5g
07-1677	Didodecylamine, min. 97% (3007-31-6) [CH ₃ (CH ₂) ₁₀ CH ₂] ₂ NH; FW: 353.67; white xtl. Note: Surfactant for nanomaterial synthesis.	1g
02-5055	N-Dodecyl-N,N-dimethyl-3-ammonio-1-propanesulfonate (Sulfobetaine 12) (14933-08-5) CH ₃ (CH ₂) ₁₁ N ⁺ (CH ₃) ₂ CH ₂ CH ₂ CH ₂ SO ₃ ⁻ ; FW: 335.55; white powdr. Note: Surfactant for nanomaterial synthesis.	10g 50g

NANOMATERIALS (Surfactants & Ligands for nano synthesis)

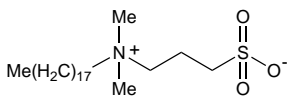
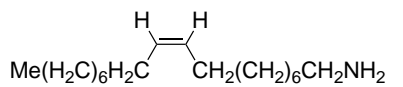
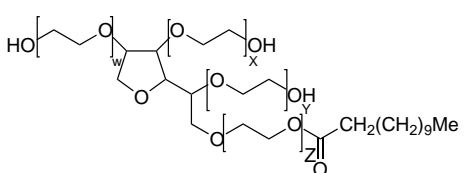
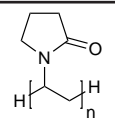
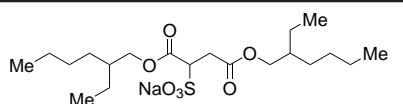
02-5045 HAZ	Hexadecyltrimethylammonium bromide, 99+% CTAB (57-09-0) [CH ₃ (CH ₂) ₁₅ N(CH ₃) ₃ ⁺ Br ⁻ ; FW: 364.45; white solid; m.p. 248-251° Note: Surfactant for nanomaterial synthesis.	50g 250g
03-1180	Lithium dodecyl sulfate, min. 98% (2044-56-6) CH ₃ (CH ₂) ₁₁ OSO ₃ ⁻ Li ⁺ ; FW: 272.33; white solid Note: Surfactant for nanomaterial synthesis.	1g 5g
02-5056	N-Octyldecyl-N,N-dimethyl-3-ammonio-1-propanesulfonate (Sulfobetaine 18) (13177-41-8) FW: 419.70; white solid Note: Surfactant for nanomaterial synthesis.	5g 25g
		
06-4010	Oleic acid, 99% (112-80-1) CH ₃ (CH ₂) ₇ =CH(CH ₂) ₇ COOH; FW: 282.46; liq.; m.p. 13°; b.p. 194-195° (1.2mm); d. 0.89 Note: Surfactant for nanomaterial synthesis.	5g 25g
07-1665	Oleylamine, min. 70% (112-90-3) CH ₃ (CH ₂) ₇ CH=CH(CH ₂) ₇ CH ₂ NH ₂ ; FW: 267.49; colorless liq.; m.p. 18-26°; b.p. 348-350°; d. 0.813 Note: Surfactant for nanomaterial synthesis.	5g 25g
07-1668	Oleylamine, min. 95% (112-90-3) CH ₃ (CH ₂) ₇ CH=CH(CH ₂) ₇ CH ₂ NH ₂ ; FW: 267.49; colorless liq.; m.p. 18-26°; b.p. 348-350°; d. 0.813 Note: Surfactant for nanomaterial synthesis.	5g 25g
		
09-5950	Perfluorotetradecanoic acid, min. 97% (376-06-7) CF ₃ (CF ₂) ₁₂ COOH; FW: 714.11; white solid; m.p. 130-135°; b.p. 270° (740mm); d. 0.89 Note: Surfactant for nanomaterial synthesis.	1g
06-5075	Polyethylene glycol dodecyl ether (Brij™ 35) (9002-92-0) CH ₃ (CH ₂) _n CH ₂ (OCH ₂ CH ₂) _n OH (n~23); FW: ~1199.54; liq. (white solid @ room temperature); m.p. 41-45° Note: Surfactant for nanomaterial synthesis.	250g 1kg
08-1650	Polyethylene glycol sorbitan monolaurate (TWEEN® 20) (9005-64-5) FW: ~1228; viscous liq.; d. 1.095 Note: Surfactant for nanomaterial synthesis.	5g 25g
		
07-1815	Polyvinylpyrrolidone (average mol. Wt. 10,000) PVP10 (9003-39-8) (C ₆ H ₉ NO) _n ; white powdr. Note: Surfactant for nanomaterial synthesis.	50g 250g
		
07-1817	Polyvinylpyrrolidone (average mol.wt. 40,000) PVP40 (9003-39-8) (C ₆ H ₉ NO) _n ; white powdr. Note: Surfactant for nanomaterial synthesis.	50g 250g
11-2750	Sodium dioctylsulfosuccinate (AOT), min. 95% (577-11-7) C ₂₀ H ₃₆ NaO ₇ S; FW: 444.56; white powdr.; m.p. 176° Note: Surfactant for nanomaterial synthesis.	50g 250g
		
11-1140	Sodium dodecylsulfate, 98+% (151-21-3) CH ₃ (CH ₂) ₁₁ OSO ₃ ⁻ Na ⁺ ; FW: 288.38; white xtl.; m.p. 204-207°	25g 100g
11-1285	Sodium dodecylsulfate, min. 99% (151-21-3) CH ₃ (CH ₂) ₁₁ OSO ₃ ⁻ Na ⁺ ; FW: 288.38; white solid; m.p. 204-207° Note: Surfactant for nanomaterial synthesis.	50g 250g

NANOMATERIALS (Surfactants & Ligands for nano synthesis)

11-1280	Sodium oleate, 99% (143-19-1) CH ₃ (CH ₂) ₇ CH=CH(CH ₂) ₇ COO-Na ⁺ ; FW: 304.44; white powdr.; m.p. 232-235° Note: Surfactant for nanomaterial synthesis.	5g 25g
02-5065 HAZ	Tetramethylammonium hydroxide pentahydrate, min. 95% (10424-65-4) (CH ₃) ₄ N(OH)·5H ₂ O; FW: 181.23; white solid; m.p. 67-70° Note: Surfactant for nanomaterial synthesis.	10g 50g
02-5040	Tetraoctylammonium chloride, min. 97% (3125-07-3) [CH ₃ (CH ₂) ₇] ₄ N ⁺ Cl ⁻ ; FW: 502.34; white xtl. Note: Surfactant for nanomaterial synthesis.	1g
08-2180	DL-α-Tocopherol methoxypolyethylene glycol succinate solution (2 wt% in water) TPGS-750-M See page 221	
15-6655	Tri-n-octylphosphine, min. 97% TOP (4731-53-7) See page 329	
15-6660	Trioctylphosphine oxide, min. 90% TOPO (78-50-2) See page 329	
15-6661	Trioctylphosphine oxide, 99% TOPO (78-50-2) See page 329	
15-6375	Tris(3-hydroxypropyl)phosphine, min. 80% (4706-17-6) See page 332	

NEODYMIUM (Elemental Forms)

93-6041	Neodymium chips (99.9% REO) (7440-00-8) Nd; FW: 144.24; chips; m.p. 1024°; b.p. 3027°; d. 7.00 <i>air sensitive, moisture sensitive</i>	10g 50g
93-6045	Neodymium foil (99.9% REO) (7440-00-8) Nd; FW: 144.24; 0.75 mm thick (~2.7g/25 x 25mm) (packed in mineral oil); m.p. 1024°; b.p. 3027°; d. 7.00 <i>air sensitive, moisture sensitive</i>	25 x 25mm 50 x 50mm
93-6042	Neodymium ingot (99.9% REO) (7440-00-8) Nd; FW: 144.24; (packed in mineral oil); m.p. 1024°; b.p. 3027°; d. 7.00 <i>air sensitive, moisture sensitive</i> For detailed technical note visit strem.com .	25g 100g
60-0175 HAZ	Neodymium powder (99.8% REO) (7440-00-8) Nd; FW: 144.24; -40 mesh; m.p. 1024°; b.p. 3027°; d. 7.00 <i>air sensitive, moisture sensitive</i>	5g 25g

NEODYMIUM (Compounds)

93-6020	Neodymium(III) acetate hydrate (99.9%-Nd) (REO) (6192-13-8) Nd(OOCCH ₃) ₃ ·XH ₂ O; FW: 321.38; light purple xtl.	50g 250g
93-6002	Neodymium(III) bromide, anhydrous (99.9%-Nd) (REO) (13536-80-6) NdBr ₃ ; FW: 383.97; off-white powdr.; m.p. 684°; b.p. 1540° <i>hygroscopic</i>	5g 25g
93-6003	Neodymium(III) carbonate hydrate (99.9%-Nd) (REO) (38245-38-4) Nd ₂ (CO ₃) ₃ ·XH ₂ O; FW: 468.51; light purple powdr.	25g 100g
93-6022	Neodymium(III) chloride, anhydrous (99.9%-Nd) (REO) (10024-93-8) NdCl ₃ ; FW: 250.60; bluish-pink powdr.; m.p. 784°; d. 4.134 <i>hygroscopic</i>	10g 50g
93-6030	Neodymium(III) chloride hexahydrate (99.9%-Nd) (REO) (13477-89-9) NdCl ₃ ·6H ₂ O; FW: 250.60 (358.69); purple xtl.; m.p. 124°; d. 2.282	10g 50g 250g
60-6030	Neodymium(III) chloride hydrate (99.997%-Nd) (REO) PURATREM (13477-89-9) NdCl ₃ ·XH ₂ O; FW: 250.60; purple xtl. <i>hygroscopic</i>	10g 50g
60-2400	Neodymium(III) 2-ethylhexanoate (10-15% Nd) (73227-23-3) Nd[OOCCH(C ₂ H ₅)C ₄ H ₉] ₃ ; FW: 573.86; viscous liq.	5g 25g
93-6023	Neodymium(III) fluoride, anhydrous (99.9%-Nd) (REO) (13709-42-7) NdF ₃ ; FW: 201.24; purple powdr.; m.p. 1410°; b.p. 2300°; d. 6.506 <i>hygroscopic</i>	25g 100g

NEODYMIUM (Compounds)

93-6005	Neodymium(III) hexafluoroacetylacetonate dihydrate (99.9%-Nd) (REO) (47814-18-6) Nd(CF ₃ COCHCOF ₃) ₃ ·2H ₂ O; FW: 765.39 (801.42); purple xtl.	5g
93-6007	Neodymium(III) iodide, anhydrous (99.9%-Nd) (13813-24-6) NdI ₃ ; FW: 524.94; light green powdr.; m.p. 775° <i>hygroscopic</i>	1g 5g
93-6008 HAZ	Neodymium(III) nitrate hexahydrate (99.9%-Nd) (REO) (16454-60-7) Nd(NO ₃) ₃ ·6H ₂ O; FW: 330.26 (438.35); purple xtl. <i>hygroscopic</i>	25g 100g
93-6024 HAZ	Neodymium(III) nitrate hexahydrate (99.999%-Nd) (REO) PURATREM (16454-60-7) Nd(NO ₃) ₃ ·6H ₂ O; FW: 330.26 (438.35); purple xtl. <i>hygroscopic</i>	5g 25g
93-6034	Neodymium(III) oxalate decahydrate (99.9%-Nd) (REO) (14551-74-7) Nd ₂ (C ₂ O ₄) ₃ ·10H ₂ O; FW: 552.55 (732.71); rose xtl.	10g 50g
93-6031	Neodymium(III) oxide (99.9%-Nd) (REO) (1313-97-9) Nd ₂ O ₃ ; FW: 336.48; blue powdr.; m.p. 2272°; d. 7.24	50g 250g
93-6009	Neodymium(III) oxide (99.99+%-Nd) (REO) PURATREM (1313-97-9) Nd ₂ O ₃ ; FW: 336.48; blue powdr.; m.p. 2272°; d. 7.24	5g 25g
93-6010 HAZ	Neodymium(III) perchlorate, 50% aqueous solution (99.9%-Nd) (REO) (13498-06-1) Nd(ClO ₄) ₃ ; FW: 442.67; lilac colored liq.	10g 50g
93-6012 HAZ	Neodymium(III) i-propoxide (99.9%-Nd) (REO) (19236-15-8) Nd[OCH(CH ₃) ₂] ₃ ; FW: 321.51; light blue powdr. <i>moisture sensitive</i>	1g 5g
93-6017	Neodymium(III) trifluoroacetylacetonate (99.9%-Nd) (37473-67-9) Nd(CF ₃ COCHCOCH ₃) ₃ ; FW: 603.48; bluish-pink xtl.; m.p. 140-142°	1g 5g
60-5200	Neodymium(III) trifluoromethanesulfonate, min. 98% (Neodymium triflate) (34622-08-7) Nd(CF ₃ SO ₃) ₃ ; FW: 591.45; purple powdr. <i>hygroscopic</i>	5g 25g
60-5000 amp HAZ	Tris(cyclopentadienyl)neodymium, 99% (99.9%-Nd) (REO) (1273-98-9) (C ₅ H ₅) ₃ Nd; FW: 339.53; blue to purple powdr.; b.p. subl. 220°/0.01mm <i>air sensitive, moisture sensitive</i>	1g 5g 25g
60-5500	Tris(6,6,7,7,8,8,8-heptafluoro-2,2-dimethyl-3,5-octanedionate)neodymium(III), 99% (99.9%-Nd) (REO) [Nd(FOD)₃] (17978-76-6) Nd(C ₃ F ₇ COCHCOOC ₂ H ₅) ₃ ; FW: 1029.77; blue-pink solid	1g 5g
60-6000 amp	Tris(i-propylcyclopentadienyl)neodymium (99.9%-Nd) (REO) (69021-85-8) (C ₃ H ₇ C ₅ H ₅) ₃ Nd; FW: 465.77; purple solid <i>air sensitive, moisture sensitive</i>	1g 5g
60-7500 amp	Tris(tetramethylcyclopentadienyl)neodymium (99.9%-Nd) (REO) (164528-22-7) [(CH ₃) ₄ C ₅ H ₅] ₃ Nd; FW: 507.85; yellow-green solid <i>air sensitive, moisture sensitive</i>	1g 5g
60-8750	Tris(2,2,6,6-tetramethyl-3,5-heptanedionato)neodymium(III), 99% (99.9%-Nd) (REO) [Nd(TMHD)₃] (15492-47-4) Nd(C ₁₁ H ₁₉ O ₂) ₃ ; FW: 694.06; light purple xtl.; m.p. 209-212°; b.p. dec. 270° (subl. 150°/0.1mm)	1g 5g
NICKEL (Elemental Forms)		
28-0001	Nickel foil (99%) (7440-02-0) Ni; FW: 58.71; 0.127mm thick x 30mm wide; m.p. 1453°; b.p. 2732°; d. 8.90	20cm 100cm
28-0002	Nickel foil (99%) (7440-02-0) Ni; FW: 58.71; 0.127mm thick x 30cm wide (~67.8g/20 x 30cm); m.p. 1453°; b.p. 2732°; d. 8.90	20 x 30cm 100 x 30cm 500 x 30cm
28-0003	Nickel foil (99%) (7440-02-0) Ni; FW: 58.71; 0.0254mm thick x 30cm wide (~13.6g/20 x 30cm); m.p. 1453°; b.p. 2732°; d. 8.90	20 x 30cm 100 x 30cm
93-2873	Nickel foil (99.5%) (7440-02-0) Ni; FW: 58.71; 0.79 mm thick x 100 mm wide; m.p. 1453°; b.p. 2732°; d. 8.90	100 x 100mm 500 x 100mm

NICKEL (Elemental Forms)

93-2875	Nickel foil (99.9%) (7440-02-0)	150 x 150mm 300 x 300mm
	Ni; FW: 58.71; 0.025 mm thick; m.p. 1453°; b.p. 2732°; d. 8.90	
28-1910	Nickel (skeletal), molybdenum promoted (1 wt%) (supplied under water)	50g
HAZ	(Actimet® 8040P) (7440-02-0) black powdr. (d50=35 µm)	250g
	Note: Sold in collaboration with BASF for research purposes only.	

Technical Note:

1. Actimet® 8040P catalyst is particularly useful for the hydrogenation of nitriles and nitro groups to amines.

28-0005	Nickel pellets (99.9%) (7440-02-0)	250g 1kg
	Ni; FW: 58.71; 5-12mm; m.p. 1453°; b.p. 2732°; d. 8.90	
93-2883	Nickel powder (99.5%) (7440-02-0)	100g
HAZ	Ni; FW: 58.71; -100 mesh; m.p. 1453°; b.p. 2732°; d. 8.90	500g
93-2867	Nickel powder (99.9%) (7440-02-0)	100g
HAZ	Ni; FW: 58.71; -300 mesh; m.p. 1453°; b.p. 2732°; d. 8.90	500g
93-2880	Nickel powder (99.9%) (7440-02-0)	100g
HAZ	Ni; FW: 58.71; 3-7 micron; m.p. 1453°; b.p. 2732°; d. 8.90	500g
28-1900	Nickel, 64% powder on silica, reduced and stabilized (Ni-5249P) (7440-02-0)	50g
HAZ	black powdr. (d50=5 µm); SA: 55m ² /g	250g
	Note: Sold in collaboration with BASF for research purposes only.	

Technical Note:

1. Ni-5249P catalyst can be used in the slurry phase hydrogenation of nitro groups, fatty nitriles, saturated aromatics and double bonds. Also used for the hydrogenation of glucose, dextrose or sorbitol.

93-2881	Nickel rod (99+% (7440-02-0)	30cm 120cm
	Ni; FW: 58.71; 6.35 mm dia.; m.p. 1453°; b.p. 2732°; d. 8.90	
93-2882	Nickel rod (99+% (7440-02-0)	30cm 120cm
	Ni; FW: 58.71; 3.2 mm dia.; m.p. 1453°; b.p. 2732°; d. 8.90	
93-2876	Nickel tubing (99.5%) (7440-02-0)	30cm 120cm
	Ni; FW: 58.71; 6.35 mm O.D. x 0.35 mm wall; m.p. 1453°; b.p. 2732°; d. 8.90	
28-1916	Nickel (skeletal), unpromoted (supplied under water) (Actimet® M) (7440-02-0)	50g
HAZ	black powdr. (d50=35 µm)	250g
	Note: Sold in collaboration with BASF for research purposes only.	

Technical Note:

1. Actimet® M catalyst is a versatile catalyst that is recommended for use in the hydrogenation of aromatics and other olefinic compounds. Also useful for the reduction of carbonyl groups and the ammonolysis of alcohols.

93-2871	Nickel wire (99%) (7440-02-0)	25m 100m
	Ni; FW: 58.71; 0.5 mm dia.; m.p. 1453°; b.p. 2732°; d. 8.90	
93-2869	Nickel wire (99+% (7440-02-0)	10m 50m
	Ni; FW: 58.71; 1 mm dia.; m.p. 1453°; b.p. 2732°; d. 8.90	
28-1500	Nickel wire (99.995%) (7440-02-0)	25cm 100cm
	Ni; FW: 58.71; 1mm dia.; m.p. 1453°; b.p. 2732°; d. 8.90	
93-2865	Nickel wire cloth, 34 x 34 mesh (7440-02-0)	300 x 600mm 1200 x 600mm
	Ni; FW: 58.71; 0.13 mm wire dia. x 600 mm wide; m.p. 1453°; b.p. 2732°; d. 8.90	
28-0008	Nickel/tetra-n-octylammonium bromide colloid, purified (65-70% Ni) (7440-02-0)	
	See page 161	
28-1890	Sponge nickel catalyst (50% aqueous slurry) (7440-02-0)	100g
HAZ	Ni (50% slurry in water); FW: 58.71; 50% in water; SA: 80-100 m ² /g; d. 8.90 (as nickel metal)	500g
	air sensitive	

NICKEL (Compounds)

28-0010	Bis(1,5-cyclooctadiene)nickel (0), 98+% (1295-35-8)	2g 10g
HAZ	(C ₈ H ₁₂) ₂ Ni; FW: 275.08; yellow xtl.; m.p. 60° dec. (under N ₂) air sensitive, (store cold) For detailed technical note visit strem.com .	
28-1301	Bis(cyclopentadienyl)nickel, 99% (Nickelocene) (1271-28-9)	5g
HAZ	(C ₅ H ₅) ₂ Ni; FW: 188.90; dark green xtl.; m.p. 173-174° air sensitive, (store cold)	25g 100g

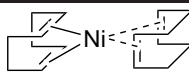

NICKEL (Compounds)

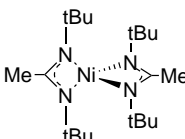
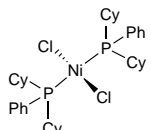
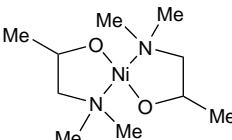
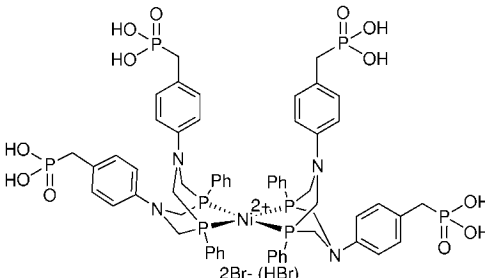
28-0045 amp	Bis(N,N'-di-t-butylacetamidinato)nickel(II), (99.999%-Ni) PURATREM (940895-79-4) $C_{26}H_{42}N_4Ni$; FW: 397.27; dark, purple-black xtl.; m.p. 87° <i>air sensitive, moisture sensitive</i> Note: Product sold under, use subject to, terms and conditions of label license at www.strem.com/harvard2 . For detailed technical note visit strem.com .		250mg 1g 5g
28-1330	trans-Bis(dicyclohexylphenylphosphino)nickel(II) chloride, 99% (19232-03-2) $C_{36}H_{54}Cl_2NiP_2$; FW: 678.40; purple powder. For detailed technical note visit strem.com .		250mg 1g
28-0025 NEW	Bis[1-(N,N-dimethylamino)-2-propanolato]nickel(II), 99% NiDMAP (200284-92-0) $C_{10}H_{24}N_2NiO_2$; FW: 263.00; green xtl.		500mg 2g
28-1720 NEW	Bis(P,P'-1,5-diphenyl-3,7-bis[(4-hydrogenphosphonate)phenyl]-1,5,3,7-diazadiphosphocine)nickel(II) bromide (hydrogen bromide adduct) (1514896-39-9) $C_{60}H_{69}Br_3Ni_2O_{12}P_8$; FW: 1584.41; red-brown xtls. <i>air sensitive, moisture sensitive</i> For detailed technical note visit strem.com .		5mg 25mg
28-0030	1,2-Bis(diphenylphosphino)ethane nickel(II) chloride, 99% (14647-23-5) $[(C_6H_5)_2PCH_2CH_2P(C_6H_5)_2]NiCl_2$; FW: 528.04; orange xtl.		2g 10g 50g
28-0080	1,3-Bis(diphenylphosphino)propane nickel(II) chloride, 99% (15629-92-2) $[(C_6H_5)_2PCH_2CH_2CH_2P(C_6H_5)_2]NiCl_2$; FW: 542.08; red xtl. For detailed technical note visit strem.com .		5g 25g
28-0083 amp HAZ	Bis(ethylcyclopentadienyl)nickel, min. 98% (31886-51-8) $[(C_2H_5)_5C_5H_4]_2Ni$; FW: 244.99; green liq. <i>air sensitive, (store cold)</i>		1g 5g
28-0085 amp HAZ	Bis(pentamethylcyclopentadienyl)nickel, 98% (Decamethylnickelocene) (74507-63-4) $[(CH_3)_5C_5]_2Ni$; FW: 329.17; greenish-black xtl. <i>air sensitive, (store cold)</i>		1g 5g
28-0086 amp HAZ	Bis(i-propylcyclopentadienyl)nickel, min. 98% (57197-55-4) $[(C_3H_7)_5C_5H_4]_2Ni$; FW: 273.04; green liq. <i>air sensitive, (store cold)</i>		1g 5g
28-0087 amp HAZ	Bis(tetramethylcyclopentadienyl)nickel, min. 98% (79019-60-6) $[(CH_3)_4C_5H_2]_2Ni$; FW: 301.10; green-black xtl. <i>air sensitive, (store cold)</i>		1g 5g
28-0088	Bis(2,2,6,6-tetramethyl-3,5-heptanedionato)nickel(II), min. 98% (99.9%-Ni) [Ni(TMHD)₂] (14481-08-4) $Ni(C_{11}H_{18}O_2)_2$; FW: 425.23; purple xtl.; m.p. 223-225°; b.p. subl. 90-110°/0.1mm <i>hygroscopic</i>		1g 5g 25g

NICKEL (Compounds)

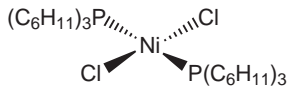
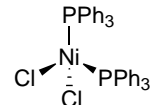
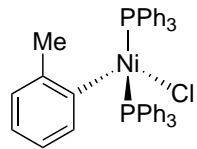
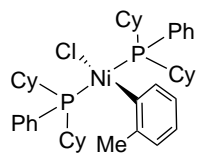
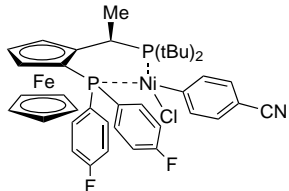
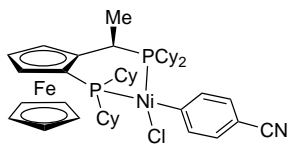
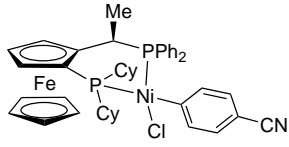
28-0091	Bis(tricyclohexylphosphine)nickel(II) chloride, 99% (19999-87-2) [(C ₆ H ₁₁) ₃ P] ₂ NiCl ₂ ; FW: 690.46; dark red-purple xtls. For detailed technical note visit strem.com .		1g 5g
28-0092	Bis(triphenylphosphine)nickel(II) bromide, 99% (14126-37-5) [(C ₆ H ₅) ₃ P] ₂ NiBr ₂ ; FW: 743.12; green xtl.; m.p. 219-223°		10g 50g
28-0095	Bis(triphenylphosphine)nickel(II) chloride, 99% (14264-16-5) [(C ₆ H ₅) ₃ P] ₂ NiCl ₂ ; FW: 654.20; green xtl. For detailed technical note visit strem.com .		5g 25g
28-0100	Bis(triphenylphosphine)nickel dicarbonyl, 98% (13007-90-4) [(C ₆ H ₅) ₃ P] ₂ Ni(CO) ₂ ; FW: 639.29; light yellow xtl.; m.p. 210-215° dec. <i>air sensitive</i>		5g 25g 100g
28-0096	Bis(triphenylphosphino)(2-methylphenyl)chloronickel(II), 99% (27057-09-6) C ₄₃ H ₃₇ ClNiP ₂ ; FW: 709.85; yellow powd. For detailed technical note visit strem.com .		250mg 1g
28-0150	Chlorobis(dicyclohexylphenylphosphino)(2-methylphenyl)nickel(II), 99% (1419179-26-2) C ₄₃ H ₆₁ ClNiP ₂ ; FW: 734.04; yellow powd. For detailed technical note visit strem.com .		100mg 500mg
28-0110	Chlorobis(triphenylphosphino)phenylnickel(II), 98% (33571-43-6) C ₄₂ H ₃₅ ClNiP ₂ ; FW: 695.78; yellow powd. <i>air sensitive, moisture sensitive</i> For detailed technical note visit strem.com .		500mg 2g
28-0178	Chloro(4-cyanophenyl){(R)-1-[(S)-2-(bis(4-fluorophenyl)phosphino)ferrocenyl]ethyl(-di-t-butylphosphine)nickel(II)} C ₃₉ H ₄₂ ClF ₂ FeNNiP ₂ ; FW: 774.69 Note: Sold in collaboration with Solvias for research purposes only.		100mg 500mg
28-0172	Chloro(4-cyanophenyl){(R)-1-[(S)-2-(dicyclohexylphosphino)ferrocenyl]ethyl (dicyclohexylphosphine)nickel(II)} C ₄₃ H ₆₀ ClFeNNiP ₂ ; FW: 802.88 Note: Sold in collaboration with Solvias for research purposes only.		100mg 500mg
28-0175	Chloro(4-cyanophenyl){(R)-1-[(S)-2-(dicyclohexylphosphino)ferrocenyl]ethyl (diphenylphosphine)nickel(II)} C ₄₃ H ₄₈ ClFeNNiP ₂ ; FW: 790.79 Note: Sold in collaboration with Solvias for research purposes only.		100mg 500mg

NICKEL (Compounds)

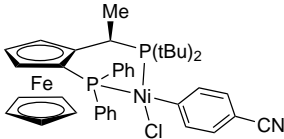
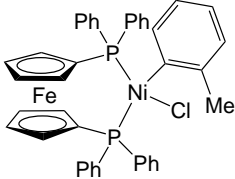
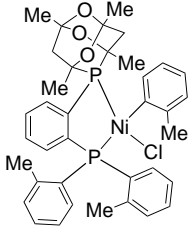
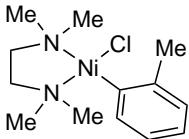
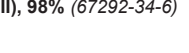
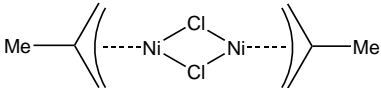
28-0170	Chloro(4-cyanophenyl){(R)-1-[(S)-2-(diphenylphosphino)ferrocenyl]ethyl(di-t-butyl)phosphine} nickel(II) (1807948-77-1) C ₃₉ H ₄₄ ClFeNiP ₂ ; FW: 738.71 Note: Sold in collaboration with Solvias for research purposes only.		100mg 500mg
28-0518	Chloro(2-methylphenyl)[1,1'-bis(diphenylphosphino)ferrocene]nickel(II), 98% (1501945-23-8) C ₄₁ H ₃₅ ClFeNiP ₂ ; FW: 739.66; yellow powdr. <i>air sensitive</i> For detailed technical note visit strem.com .		100mg 500mg
28-1090	Chloro(2-methylphenyl)[1,3,5,7-tetramethyl-8-(2-di-o-tolylphosphinophenyl)-2,4,6-trioxo-8-phosphaadamantane]nickel(II), Stradiotto PAD-DaiPhos Nickel Catalyst (1902911-45-8) C ₃₇ H ₄₁ ClNiO ₃ P ₂ ; FW: 689.81; brown powdr. Note: Patent No. 62/171,370 For detailed technical note visit strem.com .		250mg 1g
28-0165	Chloro(2-methylphenyl)(N,N,N',N'-tetramethyl-1,2-ethylenediamine)nickel(II), 99% (contains about 5% o-chlorotoluene) NiCl(o-tolyl)(TMEDA) (1702744-45-3) C ₁₃ H ₂₃ ClN ₂ Ni; FW: 301.48; dark-orange powdr. <i>air sensitive</i> For detailed technical note visit strem.com .		500mg 2g 10g
28-0500	Dichloro[1,1'-bis(diphenylphosphino)ferrocene]nickel(II), 98% (67292-34-6) [(C ₆ H ₄ P(C ₆ H ₅) ₂) ₂ Fe]NiCl ₂ ; FW: 684.00; green micro xtl. For detailed technical note visit strem.com .		1g 5g
93-2823	Hexaaminenickel(II) chloride, 98% (10534-88-0) [Ni(NH ₃) ₆]Cl ₂ ; FW: 231.80; purple xtl.; d. 1.468		25g 100g
93-2824	Hexaaminenickel(II) iodide, 98% (13859-68-2) [Ni(NH ₃) ₆]I ₂ ; FW: 414.70; yellow powdr.; d. 2.101		25g 100g
28-0900	Methallylnickel chloride dimer (12145-60-7) [C ₄ H ₇ NiCl] ₂ ; FW: 298.49; orange-brown xtl. <i>air sensitive, moisture sensitive, (store cold)</i>		250mg 1g
93-2803	Nickel(II) acetate tetrahydrate, 98+% (6018-89-9) Ni(OOCCH ₃) ₂ ·4H ₂ O; FW: 176.80 (248.86); green xtl.; m.p. dec.; d. 1.744 <i>hygroscopic</i>		250g 1kg
28-1100	Nickel(II) acetate tetrahydrate (99.999%-Ni) PURATREM (6018-89-9) Ni(OOCCH ₃) ₂ ·4H ₂ O; FW: 176.80 (248.86); green xtl.; m.p. dec.; d. 1.744		5g 25g
28-1130	Nickel(II) acetylacetonate, anhydrous, min. 95% (3264-82-2) Ni(CH ₃ COCHCOCH ₃) ₂ ; FW: 256.93; light green powdr.; m.p. 238° dec. <i>hygroscopic</i> For detailed technical note visit strem.com .		25g 100g
28-1110	Nickel(II) acetylacetonate hydrate (120156-44-7) Ni(CH ₃ COCHCOCH ₃) ₂ ·XH ₂ O; FW: 256.93; light green powdr. For detailed technical note visit strem.com .		100g 500g
93-2859	Nickel boride (99%-Ni) (12007-00-0) NiB; FW: 69.52; -325 mesh silver gran.; d. 7.39		10g 50g

NICKEL (Compounds)

28-1140	Nickel(II) bromide, anhydrous (99+%Ni) (13462-88-9) NiBr ₂ ; FW: 218.51; yellow to yellow-brown solid; m.p. 963°; d. 5.098 <i>hygroscopic</i>	50g 250g
28-1145 HAZ	Nickel(II) bromide, dimethoxyethane adduct, min. 97% (28923-39-9) NiBr ₂ ·CH ₃ O(CH ₂) ₂ OCH ₃ ; FW: 308.62; peach pwdr. <i>moisture sensitive</i>	1g 5g
93-2807	Nickel(II) bromide hydrate (207569-11-7) NiBr ₂ ·XH ₂ O; FW: 218.51; yellow to green xtl.; m.p. 300° dec.	50g 250g
93-2808	Nickel(II) carbonate, basic hydrate (39380-74-0) NiCO ₃ ·2Ni(OH) ₂ ·XH ₂ O; FW: 320.16; green pwdr.	50g 250g 1kg
28-1150 HAZ 	Nickel carbonyl (13463-39-3) Ni(CO) ₄ ; FW: 170.73; colorless liq.; m.p. -19.3°; b.p. 43°; f.p. -4°F; d. 1.32 <i>heat sensitive, pyrophoric</i>	100g 450g
93-2809 HAZ	Nickel(II) chloride, anhydrous, 98% (7718-54-9) NiCl ₂ ; FW: 129.62; yellow pwdr.; m.p. 1001°; d. 3.55 <i>hygroscopic</i>	50g 250g
93-2801 HAZ	Nickel(II) chloride, dimethoxyethane adduct, min. 97% (29046-78-4) NiCl ₂ ·CH ₃ O(CH ₂) ₂ OCH ₃ ; FW: 219.72; yellow pwdr. <i>moisture sensitive</i>	1g 5g 25g
93-2810 HAZ	Nickel(II) chloride hexahydrate (99.9+%Ni) (7791-20-0) NiCl ₂ ·6H ₂ O; FW: 129.62 (237.70); green xtl.	250g 1kg
28-1160 HAZ	Nickel(II) chloride hexahydrate (99.999+%Ni) PURATREM (7791-20-0) NiCl ₂ ·6H ₂ O; FW: 129.62 (237.70); green xtl.	10g 50g
93-2813	Nickel(II) cyclohexanebutyrate (AAS) (3906-55-6) Ni[OOC(CH ₂) ₃ C ₆ H ₁₁] ₂ ; FW: 397.20; green to blue xtl.	5g
93-2815	Nickel(II) dimethylglyoxime, 99% (13478-93-8) Ni(HC ₂ H ₆ N ₂ O ₂) ₂ ; FW: 288.94; reddish-purple pwdr.; m.p. 250° subl.	10g 50g
93-2830	Nickel(II) 2-ethylhexanoate, 78% in 2-ethylhexanoic acid (10-15% Ni) (4454-16-4) Ni[OOCCH(C ₂ H ₅)C ₄ H ₉] ₂ ; FW: 345.13; viscous liq.; f.p. 155°F; d. 1.08	50g 250g
93-2818	Nickel(II) fluoride, anhydrous, 99% (10028-18-9) NiF ₂ ; FW: 96.71; light green pwdr.; d. 4.63 <i>hygroscopic</i>	10g 50g
93-2819	Nickel(II) fluoride tetrahydrate, 98+% (13940-83-5) NiF ₂ ·4H ₂ O; FW: 96.71 (168.77); green pwdr.	25g 100g
93-2821	Nickel(II) hexafluoroacetylacetonate hydrate, 98% (14949-69-0) Ni(CF ₃ COCHOCF ₃) ₂ ·XH ₂ O; FW: 472.81; green xtl.; m.p. 211-213°	1g 5g
93-2847 HAZ	Nickel(II) hydroxide (12054-48-7) Ni(OH) ₂ ; FW: 92.72; green pwdr.; m.p. 230° dec.	250g 1kg
93-2826	Nickel(II) hydroxyacetate (41587-84-2) Ni(OOCCH ₂ OH) ₂ ; FW: 208.75; green pwdr.	5g 25g
93-2827	Nickel(II) iodide, anhydrous (99.5%-Ni) (13462-90-3) NiI ₂ ; FW: 312.52; -60 mesh black pwdr.; m.p. 797°; d. 5.834 <i>hygroscopic</i>	10g 50g
93-2828	Nickel(II) iodide hydrate (7790-34-3) NiI ₂ ·XH ₂ O; FW: 312.52; green xtl.	25g 100g
28-1690	Nickel(II) meso-tetraphenylporphine (14172-92-0) (C ₄₄ H ₂₈ N ₄)Ni; FW: 671.44; purple xtl.	1g 5g
93-2829 HAZ	Nickel(II) naphthenate, ~60% in toluene (6-8% Ni) (61788-71-4) viscous liq.	50g 250g
93-2860 HAZ	Nickel(II) nitrate hexahydrate (99.9+%Ni) (13478-00-7) Ni(NO ₃) ₂ ·6H ₂ O; FW: 182.72 (290.81); green flake; m.p. 56.7°; d. 2.05	250g 1kg
28-1440 HAZ	Nickel(II) nitrate hexahydrate (99.9985%-Ni) PURATREM (13478-00-7) Ni(NO ₃) ₂ ·6H ₂ O; FW: 182.72 (290.81); green xtl.; m.p. 56.7°; d. 2.05	25g 100g

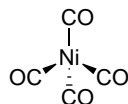

NICKEL (Compounds)

93-2831	Nickel(II) oxalate dihydrate (6018-94-6) NiC ₂ O ₄ ·2H ₂ O; FW: 146.73 (182.76); green to blue powdr.	50g 250g
28-1470	Nickel(II) oxalate dihydrate (99.998%-Ni) PURATREM (6018-94-6) NiC ₂ O ₄ ·2H ₂ O; FW: 146.73 (182.76); light green powdr.	10g 50g
93-2833	Nickel(II) oxide (99.99%-Ni) PURATREM (1313-99-1) NiO; FW: 74.71; green powdr.; m.p. 1990°; d. 6.67	25g 100g
28-1475	Nickel(II) oxide (99.998%-Ni) PURATREM (1313-99-1) NiO; FW: 74.71; greenish-black powdr.; m.p. 1990°; d. 6.67	10g 50g
93-2861	Nickel(II) oxide, black (99.9+%) (1313-99-1) NiO; FW: 74.71; -325 mesh black powdr.; m.p. 1990°; d. 6.67	100g 500g
93-2832	Nickel(II) oxide, green, 99% (1313-99-1) NiO; FW: 74.71; -325 mesh green powdr.; m.p. 1990°; d. 6.67	50g 250g
93-2834 HAZ	Nickel(II) perchlorate hexahydrate, 99% (13520-61-1) Ni(ClO ₄) ₂ ·6H ₂ O; FW: 257.61 (365.70); green xtl.; m.p. 140° <i>hygroscopic</i>	50g 250g
28-1600	Nickel(II) phthalocyanine, min. 94% (14055-02-8) (C ₃₂ H ₁₆ N ₈)Ni; FW: 571.23; purple powdr.	5g 25g

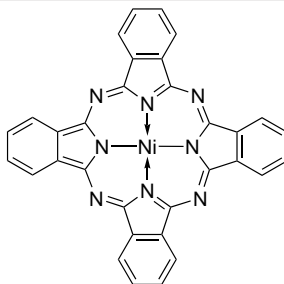

93-2845	Nickel(II) stearate (2223-95-2) Ni(O ₂ C ₁₈ H ₃₅) ₂ ; FW: 625.67; waxy green solid; d. 1.13	100g
93-2839	Nickel(II) sulfate hexahydrate, 98+% (ACS) (10101-97-0) NiSO ₄ ·6H ₂ O; FW: 154.78 (262.86); green xtl.; d. 2.07	500g 2kg
93-2856	Nickel(II) sulfate hexahydrate (99.99%-Ni) PURATREM (10101-97-0) NiSO ₄ ·6H ₂ O; FW: 154.78 (262.86); green xtl.; d. 2.07	25g 100g
93-2840	Nickel(II) sulfide (99.9%-Ni) (16812-54-7) Ni ₃ S ₂ /NiS; -200 mesh black powdr.; m.p. 797°; d. 5.3-5.65	5g 25g
93-2841	Nickel(II) tetrafluoroborate hexahydrate, 99% (15684-36-3) Ni(BF ₄) ₂ ·6H ₂ O; FW: 232.23 (340.32); green xtl.; d. 1.47	50g 250g
93-2843	Nickel(II) trifluoroacetylacetonate dihydrate, 98% (14324-83-5) Ni(CF ₃ COCHCOCH ₃) ₂ ·2H ₂ O; FW: 364.87 (400.90); green powdr.	5g 25g
28-1700	Nickel(II) trifluoromethanesulfonate, min. 98% (Nickel triflate) (60871-84-3) Ni(CF ₃ SO ₃) ₂ ; FW: 356.83; pale green powdr. <i>hygroscopic</i>	1g 5g
19-2000	Potassium hexafluoronickelate(IV), 99% (17218-47-2) See page 342	

NIOBIUM (Elemental Forms)

41-0050	Niobium foil (99.8%) (7440-03-1) Nb; FW: 92.91; 1.0mm thick (~42.9g/50 x 100mm); m.p. 2468°; b.p. 4742°; d. 8.57	50 x 100mm 100 x 200mm 500 x 200mm
41-0055	Niobium foil (99.8%) (7440-03-1) Nb; FW: 92.91; 0.25mm thick (~10.7g/50 x 100mm); m.p. 2468°; b.p. 4742°; d. 8.57	50 x 100mm 100 x 200mm
41-0060	Niobium foil (99.8%) (7440-03-1) Nb; FW: 92.91; 0.127mm thick (50 x 100mm); m.p. 2468°; b.p. 4742°; d. 8.57	1pc 5pcs
93-4135	Niobium foil (99.8%) (7440-03-1) Nb; FW: 92.91; 0.05mm thick x 100mm wide; m.p. 2468°; b.p. 4742°; d. 8.57	100 x 100mm 500 x 100mm
93-4133	Niobium powder (99.8%, Ta-0.1-1%) (7440-03-1) Nb; FW: 92.91; -60 mesh; m.p. 2468°; b.p. 4742°; d. 8.57	25g 100g

NIOBIUM (Elemental Forms)

93-4132	Niobium powder (99.8%) (7440-03-1)	25g
HAZ	Nb; FW: 92.91; -325 mesh; m.p. 2468°; b.p. 4742°; d. 8.57	100g
41-0065	Niobium rod (99.8%) (7440-03-1)	2cm
	Nb; FW: 92.91; 12.5mm dia. (~11g/cm); m.p. 2468°; b.p. 4742°; d. 8.57	10cm
41-0070	Niobium rod (99.8%) (7440-03-1)	5cm
	Nb; FW: 92.91; 6.35 mm dia. (~2.7g/cm); m.p. 2468°; b.p. 4742°; d. 8.57	25cm
		100cm
93-4130	Niobium turnings (99.8%) (7440-03-1)	25g
	Nb; FW: 92.91; irregular pieces; m.p. 2468°; b.p. 4742°; d. 8.57	100g

NIOBIUM (Compounds)

41-0450	(t-Butylimido)tris(diethylamino)niobium(V), min. 98% (210363-27-2)	1g
NEW	C ₁₆ H ₃₉ N ₄ Nb; FW: 380.41; yellow to brown orange, low melting solid	5g
HAZ	<i>air sensitive, moisture sensitive</i>	
	$\begin{array}{c} \text{NEt}_2 \\ \\ \text{t-Bu-N}=\text{Nb}-\text{NEt}_2 \\ \\ \text{NEt}_2 \end{array}$	
41-0500	Cyclopentadienylniobium(V) tetrachloride, 98% (33114-15-7)	1g
HAZ	C ₅ H ₅ NbCl ₄ ; FW: 299.82; red to brown powdr.; m.p. 180° dec. <i>moisture sensitive</i>	5g
93-4107	Niobium(V) bromide (99.9%-Nb) (13478-45-0)	10g
HAZ	NbBr ₅ ; FW: 492.49; -100 mesh reddish-brown powdr.; m.p. 150°; b.p. 361.6° <i>moisture sensitive</i>	50g
93-4126	Niobium(V) chloride (99+%-Nb) (10026-12-7)	50g
HAZ	NbCl ₅ ; FW: 270.17; yellow xtl.; m.p. 204-206°; b.p. 254°; d. 2.75 <i>moisture sensitive</i>	250g
41-1250	Niobium(V) chloride (99.99%-Nb) (20-200ppm Ta) PURATREM (10026-12-7)	5g
HAZ	NbCl ₅ ; FW: 270.17; yellow xtl.; m.p. 204-206°; b.p. 254°; d. 2.75 <i>moisture sensitive</i>	25g
		100g
93-4104	Niobium(V) ethoxide (99.9+%-Nb) (3236-82-6)	5g
amp	Nb(OC ₂ H ₅) ₅ ; FW: 318.22; yellow to orange liq.; m.p. 6°; b.p. 142°/0.1mm; d. 1.32	25g
HAZ	<i>moisture sensitive</i>	
41-1260	Niobium(IV) 2-ethylhexanoate (206564-87-6)	10g
	Nb[OOCCH(C ₂ H ₅)C ₄ H ₉] ₄ ; FW: 665.73; yellow viscous liq. <i>moisture sensitive</i>	50g
93-4121	Niobium(V) fluoride, 99.5% (7783-68-8)	5g
HAZ	NbF ₅ ; FW: 187.91; white powdr.; m.p. 72°; b.p. ~220°; d. 3.92 <i>moisture sensitive</i>	25g
	Note: Packaged in PFA/FET bottle.	
41-4110	Niobium(IV) oxide, 99+% (12034-59-2)	2g
	Nb ₂ O ₅ ; FW: 124.91; -200 mesh powdr.; d. 5.9	10g
		50g
93-4111	Niobium(V) oxide (99.5%-Nb) (1313-96-8)	50g
	Nb ₂ O ₅ ; FW: 265.82; white powdr.; m.p. 1520°; d. 4.47	250g
93-4109	Niobium(V) oxide (99.9%-Nb) (1313-96-8)	50g
	Nb ₂ O ₅ ; FW: 265.82; white powdr.; m.p. 1520°; d. 4.47	250g
41-5200	Niobium(V) oxide (99.995%-Nb) (50-100ppm Ta) PURATREM (1313-96-8)	25g
	Nb ₂ O ₅ ; FW: 265.82; white powdr.; m.p. 1520°; d. 4.47	100g
41-5300	Pentakis(dimethylamino)niobium(V), 99% (19824-58-9)	1g
HAZ	Nb[N(CH ₃) ₂] ₅ ; FW: 313.29; purple-black xtl. <i>moisture sensitive</i>	5g
41-6500	Tetrachlorobis(tetrahydrofuran)niobium(IV) (61247-57-2)	5g
HAZ	NbCl ₄ (C ₄ H ₈ O) ₂ ; FW: 378.94; yellow to orange powdr.; m.p. 93° (dec.) <i>moisture sensitive</i>	25g
41-7000	Tetrakis(2,2,6,6-tetramethyl-3,5-heptanedionato)niobium(IV), 99% [Nb(TMHD)₄] (41706-15-4)	1g
	Nb(C ₁₁ H ₁₉ O ₂) ₄ ; FW: 826.00; black xtl.; m.p. 219-220°; b.p. dec. 325°	5g
		25g

NIOBIUM (Compounds)

41-0510 Trihydridobis(pentamethylcyclopentadienyl)niobium(V)
HAZ (93558-77-1)
[(CH₃)₅C₅]₂NbH₃; FW: 366.38; light-brown powdr.
air sensitive

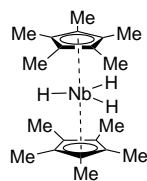

100mg
500mg

NITROGEN (Compounds)

07-1712 (8 α , 9S)-(+)-9-Amino-cinchonan-6'-ol, min. 90%
(960050-59-3)
C₁₉H₂₃N₃O; FW: 309.41; off-white to pale brown
powdr.
(store cold)
For detailed technical note visit strem.com.

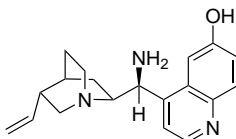

50mg
250mg

07-1717 (9R)-(+)-9-Amino-cinchonan-6'-ol, min. 90%
(960050-60-6)
C₁₉H₂₃N₃O; FW: 309.41; off-white to pale brown powdr.
(store cold)
For detailed technical note visit strem.com.

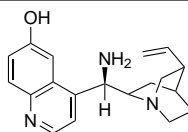

50mg
250mg

07-0040 (1R,2S)-2-Amino-1,2-diphenylethanol, min. 98% (23190-16-1)
C₁₄H₁₅NO; FW: 213.28; white to light-yellow powdr.
Note: Sold in collaboration with Daicel for research purposes only.
For detailed technical note visit strem.com.

NEW

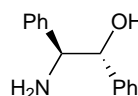

5g
25g

07-0041 (1S,2R)-2-Amino-1,2-diphenylethanol, min. 98% (23364-44-5)
C₁₄H₁₅NO; FW: 213.28; white to light-yellow powdr.
Note: Sold in collaboration with Daicel for research purposes only.

NEW

Technical Note:

1. See 07-0040 (page 178)

07-2345 N-[(1R,2R)-2-Amino-1,2-diphenylethyl]-2,4,6-tris(1-methylethyl)benzenesulfonamide, 98% (R,R)-TipsDPEN (852212-92-1)
C₂₉H₃₈N₂O₂S; FW: 478.69; white to tan powdr.
Note: Manufactured under license of Takasago patent.

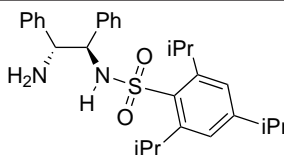

1g
5g

07-2346 N-[(1S,2S)-2-Amino-1,2-diphenylethyl]-2,4,6-tris(1-methylethyl)benzenesulfonamide, 98% (S,S)-TipsDPEN (247923-41-7)
C₂₉H₃₈N₂O₂S; FW: 478.69; white solid
Note: Manufactured under license of Takasago patent.

1g
5g

07-0200 (1S,2R)-(-)-cis-1-Aminoindan-2-ol, 98% (126456-43-7)
C₉H₁₁NO; FW: 149.19; white to off-white powdr.; m.p. 117-121°
Note: CATHy™ Catalyst Kit component.
For detailed technical note visit strem.com.

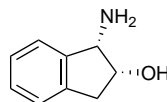

1g
5g
25g

07-0201 (1R,2S)-(+)-cis-1-Aminoindan-2-ol, 98% (136030-00-7)
C₉H₁₁NO; FW: 149.19; white to off-white powdr.; m.p. 117-121°
Note: CATHy™ Catalyst Kit component.

1g
5g
25g

Technical Note:

1. See 07-0200 (page 178)

07-0519 (2R)-2-Amino-3-methyl-N-2-pyridinylbutanamide, min. 98% (1568043-19-5)
C₁₆H₁₅N₃O; FW: 193.25; white to light-yellow powdr.
Note: Sold in collaboration with Daicel for research purposes only.
For detailed technical note visit strem.com.

NEW

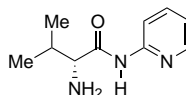

100mg
500mg

NITROGEN (Compounds)

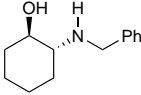
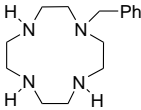
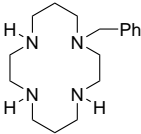
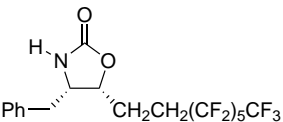
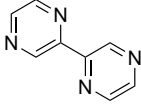
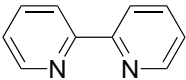
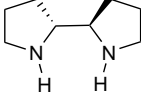
07-0518 NEW	(2S)-2-Amino-3-methyl-N-2-pyridinylbutanamide, min. 98% (167261-43-0) C ₁₆ H ₁₅ N ₃ O; FW: 193.25; white to light-yellow powdr. Note: Sold in collaboration with Daicel for research purposes only.		100mg 500mg
Technical Note: 1. See 07-0519 (page 178)			
07-0637 NEW	(1R,2R)-2-Benzylamino-1-cyclohexanol, min. 98% (141553-09-5) C ₁₃ H ₁₉ NO; FW: 205.30; white to light-yellow powdr. Note: Sold in collaboration with Daicel for research purposes only.		500mg 2g
07-0638 NEW	(1S,2S)-2-Benzylamino-1-cyclohexanol, min. 98% (322407-34-1) C ₁₃ H ₁₉ NO; FW: 205.30; white to light-yellow powdr. Note: Sold in collaboration with Daicel for research purposes only.		500mg 2g
07-0090	1-Benzyl-3-methylimidazolium phosphate, 99% See page 81		
07-1939	N-Benzyl-1,4,7,10-tetraazacyclododecane, min. 98% (112193-83-6) C ₁₅ H ₂₆ N ₄ ; FW: 262.39; white to yellow powdr.		250mg 1g
07-1957	N-Benzyl-1,4,8,11-tetraazacyclotetradecane, min. 98% (132723-93-4) C ₁₇ H ₃₀ N ₄ ; FW: 290.45; white to yellow powdr.		100mg 500mg
07-0096	(4R,5S)-(+)-4-Benzyl-5-(3,3,4,4,5,5,6,6,7,7,8,8,8-tridecafluorooctyl)-2-oxazolidinone, 99% (1391512-50-7) C ₁₈ H ₁₄ F ₁₃ NO ₂ ; FW: 523.29; white powdr.; m.p. 90-95° Note: Sold under license for research purposes only. Patent PCT US/60/661,914. For detailed technical note visit strem.com .		100mg 500mg
07-0095	(4S,5R)-(-)-4-Benzyl-5-(3,3,4,4,5,5,6,6,7,7,8,8,8-tridecafluorooctyl)-2-oxazolidinone, 99% (857637-92-4) C ₁₈ H ₁₄ F ₁₃ NO ₂ ; FW: 523.29; white powdr.; m.p. 90-95° Note: Sold under license for research purposes only. Patent PCT US/60/661,914. For detailed technical note visit strem.com .		100mg 500mg
07-0750 NEW	2,2'-Bipyrazine, 95% (10199-00-5) C ₈ H ₆ N ₄ ; FW: 158.16; light-brown solid <i>air sensitive</i> Note: Ligand for photocatalyst synthesis.		250mg 1g
07-0290 HAZ	2,2'-Bipyridine, 99+% BIPY (366-18-7) C ₁₀ H ₈ N ₂ ; FW: 156.19; white to pale-pink powdr.; m.p. 69-70°; b.p. 273°		25g 100g
07-0092	(2R,2'R)-(-)-2,2'-Bipyrrolidine, 99% (137037-20-8) C ₈ H ₁₆ N ₂ ; FW: 140.23; colorless liq. <i>air sensitive</i>		250mg 1g 5g
07-0093	(2S,2'S)-(+)-2,2'-Bipyrrolidine, 99% (124779-66-4) C ₈ H ₁₆ N ₂ ; FW: 140.23; colorless liq. <i>air sensitive</i>		250mg 1g 5g

NITROGEN (Compounds)

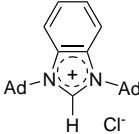
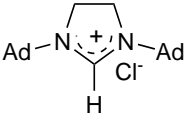
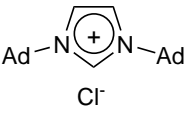
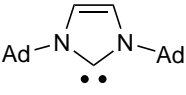
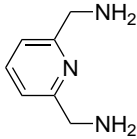
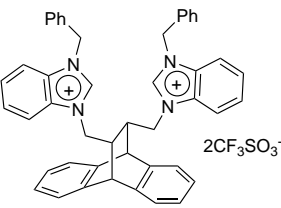
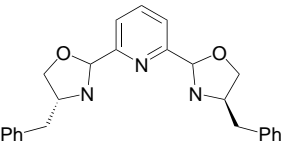
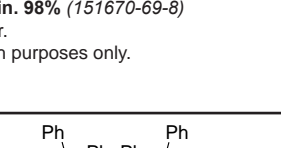
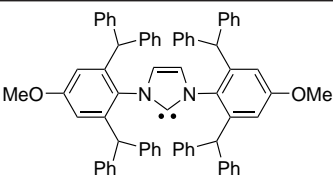
07-4005	1,3-Bis(1-adamantyl)benzimidazolium chloride, min. 97% (852634-41-4) $C_{27}H_{35}ClN_2$; FW: 423.03; yellow to orange solid <i>air sensitive</i>		500mg 2g
07-4007	1,3-Bis(1-adamantyl)-4,5-dihydroimidazolium chloride, min. 97% (871126-33-9) $C_{23}H_{35}ClN_2$; FW: 374.99; white to off-white solid <i>air sensitive</i> Note: NHC Ligand Kit 3: Variety of N-Heterocyclic Carbenes Kit component.		500mg 2g
07-0322	1,3-Bis(1-adamantyl)imidazolium chloride, min. 97% (131042-78-9) $[C_{23}H_{33}N_2]^+Cl^-$; FW: 372.97; white xtl.; m.p. 345-346° <i>hygroscopic</i> Note: NHC Ligand Kit 3: Variety of N-Heterocyclic Carbenes Kit component.		250mg 1g
07-0324 HAZ	1,3-Bis(1-adamantyl)imidazol-2-ylidene, min. 98% ARDUENGO'S CARBENE (131042-77-8) $C_{23}H_{32}N_2$; FW: 336.51; white xtl.; m.p. 240-241° <i>air sensitive, moisture sensitive, (store cold)</i> Note: NHC Ligand Kit 2: "Free" Carbenes Kit component.		250mg
07-0650 NEW	2,6-Bis(aminomethyl)pyridine, min. 85% (34984-16-2) $C_7H_{11}N_3$; FW: 137.18; low melting yellow solid <i>air sensitive</i>		1g 5g
07-0076	11,12-Bis[N-benzyl-1H-imidazolium-3-methylene]-9,10-dihydro-9,10-ethanoanthracene bis(trifluoromethanesulfonate) $[C_{38}H_{36}N_4](CF_3SO_3)_2$; FW: 846.86; white to off-white powdr. Note: Sold under license from UFRFI for research purposes only. Patent application PCT/US2008/054137. NHC Ligand Kit 4: Bis Carbenes Kit component.		100mg 500mg
07-0390 NEW	2,6-Bis[(4R)-benzyl-2-oxazolin-2-yl]pyridine, min. 98% (365215-38-9) $C_{25}H_{23}N_3O_2$; FW: 397.47; white to light-yellow powdr. Note: Sold in collaboration with Daicel for research purposes only. For detailed technical note visit strem.com .		25mg 100mg
07-0391 NEW	2,6-Bis[(4S)-benzyl-2-oxazolin-2-yl]pyridine, min. 98% (151670-69-8) $C_{25}H_{23}N_3O_2$; FW: 397.47; white to light-yellow powdr. Note: Sold in collaboration with Daicel for research purposes only.		25mg 100mg
07-0216 HAZ	N,N'-Bis(2,6-bis(diphenylmethyl)-4-methoxyphenyl)imidazol-2-ylidene, min. 98% IPr*OMe (1416368-06-3) $C_{60}H_{56}N_2O_2$; FW: 945.20; white powdr. <i>air sensitive, moisture sensitive</i> For detailed technical note visit strem.com .		250mg 1g

Technical Note:

1. See 07-0390 (page 180)

NITROGEN (Compounds)

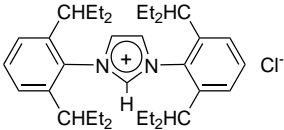
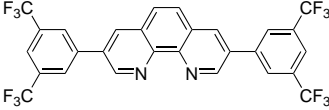
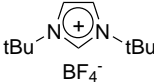
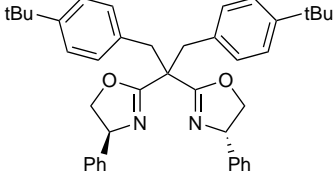
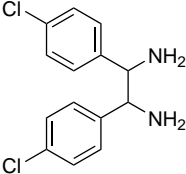
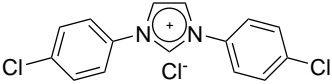
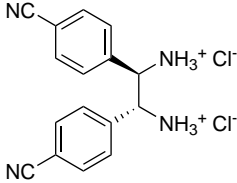
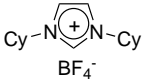
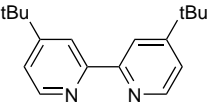
07-0358	1,3-Bis[2,6-bis(1-ethylpropyl)phenyl]imidazolium chloride, 98% IPentHCl (1440435-00-6) $C_{35}H_{53}ClN_2$; FW: 537.26; white powdr.		500mg 2g
07-0481 NEW	3,8-Bis[3,5-bis(trifluoromethyl)phenyl]phenyl]-1,10-phenanthroline (1228032-35-6) $C_{28}H_{12}F_{12}N_2$; off-white powdr.		100mg 500mg
07-0598	1,3-Bis(t-butyl)imidazolium tetrafluoroborate, min. 97% ItBuHBF₄ (263163-17-3) $[C_{11}H_{21}N_2]^+BF_4^-$; FW: 268.10; white to cream-colored solid <i>hygroscopic</i> Note: NHC Ligand Kit 3: Variety of N-Heterocyclic Carbenes Kit component.		500mg 2g
07-1235	(4S,4'-S)-2,2'-(1,3-Bis(4-(t-butyl)phenyl)propane-2,2-diyl)bis(4-phenyl-4,5-dihydrooxazole) (S)-BTBBPh-SaBOX (1428328-51-1) $C_{41}H_{46}N_2O_2$; FW: 598.81; white powdr. For detailed technical note visit strem.com .		250mg 1g
07-0487	meso-1,2-Bis(4-chlorophenyl)ethylenediamine, min. 98% (74641-30-8) $C_{14}H_{14}Cl_2N_2$; FW: 281.18; white to yellow powdr. <i>air sensitive</i>		100mg 500mg
07-0490	1,3-Bis(4-chlorophenyl)imidazolium chloride, min. 97% (141556-46-9) $[C_{15}H_{11}Cl_2N_2]^+Cl^-$; FW: 325.62; cream-colored powdr.; m.p. 251-252° <i>hygroscopic</i>		250mg
07-0220	(1R,2R)-(+)-1,2-Bis(4-cyanophenyl)ethylenediamine dihydrochloride, min. 98% (117903-80-7) $C_{16}H_{14}N_4$; 2HCl; FW: 335.23; white to off-white powdr. <i>hygroscopic</i>		100mg 500mg
07-0597	1,3-Bis(cyclohexyl)imidazolium tetrafluoroborate, min. 97% ICyHBF₄ (286014-38-8) $[C_{15}H_{25}N_2]^+BF_4^-$; FW: 320.18; white to cream-colored solid <i>hygroscopic</i>		500mg 2g
07-0273 NEW	4,4'-Bis(di-t-butyl)-2,2'-bipyridine, 97% DTBBPY (72914-19-3) $C_{18}H_{24}N_2$; FW: 268.40; white xtl. <i>hygroscopic</i> For detailed technical note visit strem.com .		1g 5g

NITROGEN (Compounds)

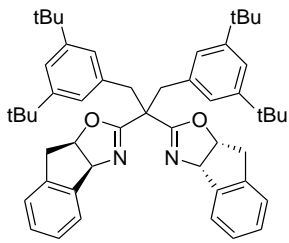
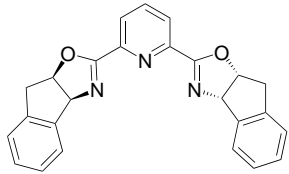
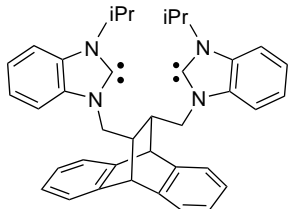
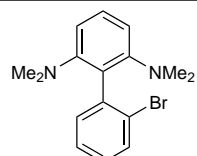
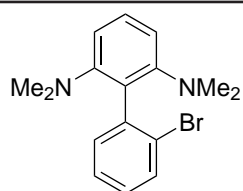
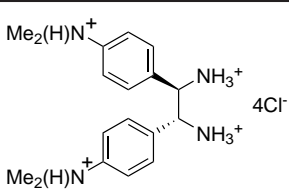
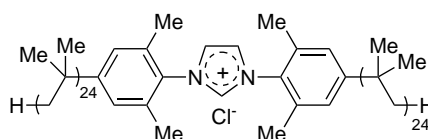
07-1228	(3a <i>S</i> ,3a' <i>S</i> ,8a <i>R</i> ,8a' <i>R</i>)-2,2'-(1,3-Bis(3,5-di- <i>t</i> -butylphenyl)propane-2,2-diyl)bis(8,8a-dihydro-3a <i>H</i> -indeno[1,2- <i>d</i>]oxazole) (S,R)-BDTIn-SaBOX (1435467-29-0) C ₅₁ H ₆₂ N ₂ O ₂ ; FW: 735.05; white solid For detailed technical note visit strem.com .		100mg 500mg
07-0280	(-)-2,6-Bis[(3a <i>S</i> ,8a <i>R</i>)-3a,8a-dihydro-8 <i>H</i> -indeno[1,2- <i>d</i>]oxazolin-2-yl]pyridine, min. 97% Indenyl-PYBOX (185346-09-2) C ₂₆ H ₁₉ N ₃ O ₂ ; FW: 393.44; white to off-white powdr.; m.p. 265° dec. For detailed technical note visit strem.com .		250mg 1g
07-0088 HAZ	11,12-Bis[1,3-dihydro-3-(<i>i</i> -propyl)-2 <i>H</i> -benzimidazol-2-ylidene-3-methylene]-9,10-dihydro-9,10-ethanoanthracene (958004-05-2) C ₃₈ H ₃₈ N ₄ ; FW: 550.74; white to off-white powdr. <i>air sensitive, moisture sensitive</i> Note: Sold under license from UFRFI for research purposes only. Patent application PCT/US2008/054137. NHC Ligand Kit 4: Bis Carbenes Kit component.		100mg 500mg
07-0230	1,3-Bis(dimethylamino)benzene, 98% (22440-93-3) C ₁₀ H ₁₆ N ₂ ; FW: 164.25; colorless liq. <i>air sensitive, light sensitive, (store cold)</i>		1g 5g
07-0428	2,6-Bis(dimethylamino)-2'-bromo-1,1'-biphenyl, min. 98% (1160556-63-7) C ₁₆ H ₁₉ BrN ₂ ; FW: 319.24; brown solid		250mg 1g
07-0226	(1 <i>R</i> ,2 <i>R</i>)-(+)-1,2-Bis(4-dimethylaminophenyl)ethylenediamine tetrahydrochloride, min. 98% (866267-84-7) C ₁₈ H ₂₆ N ₄ ·4HCl; FW: 444.27; white to yellow powdr. <i>hygroscopic</i>		100mg 500mg
07-4042 amp HAZ	1,3-Bis{2,3-dimethyl-4-[polyisobutyl(24)]phenyl}-4,5-dihydroimidazolium tetrafluoroborate (50% in hexanes/polyisobutylene) C ₂₁₁ H ₄₀₇ N ₂ BF ₄ ; FW: 3059; yellow liq.		500mg

NITROGEN (Compounds)

07-4045 amp HAZ	1,3-Bis(2,3-dimethyl-4-[polyisobutyl(20)]phenyl)imidazolium chloride (50% in hexanes/polyisobutylene) $C_{179}H_{343}N_2Cl$; FW: 2557; orange liq. For detailed technical note visit strem.com .	500mg
07-0078	11,12-Bis[N-(2,2-diphenyl-1-ethyl)-9,10-dihydro-9,10-ethanoanthracene bis(trifluoromethanesulfonate), min. 95% $[C_{60}H_{52}N_4](CF_3SO_3)_2$; FW: 1127.22; white to off-white powder. Note: Sold under license from UFRFI for research purposes only. Patent application PCT/US2008/054137. NHC Ligand Kit 4: Bis Carbenes Kit component.	100mg 500mg
07-0620 NEW	1,3-Bis(2,6-di-i-propylphenyl)-2-chloroimidazolium chloride, 98+% (1228185-09-8) $C_{27}H_{36}Cl_2N_2$; FW: 459.49; colorless solid <i>hygroscopic</i> For detailed technical note visit strem.com .	250mg 1g
07-4055 NEW	1,3-Bis(2,6-di-i-propylphenyl)-2-chloroimidazolium chloride/cesium fluoride admixture (1.0/6.7 molar ratio or 1/2.2 weight ratio) PhenoFluor®Mix (1228185-09-8) $[C_{27}H_{36}Cl_2N_2][CsF]_{6.7}$; off-white solid <i>hygroscopic</i> Note: Product sold under, use subject to, terms and conditions of label license at www.strem.com/harvard4 For detailed technical note visit strem.com .	250mg 1g
07-4009	1,3-Bis(2,6-di-i-propylphenyl)-4,5-dihydroimidazolium chloride, min. 97% (258278-25-0) $C_{27}H_{39}ClN_2$; FW: 427.06; white to off-white solid <i>air sensitive</i> Note: NHC Ligand Kit 3: Variety of N-Heterocyclic Carbenes Kit component.	500mg 2g
07-0587	1,3-Bis(2,6-di-i-propylphenyl)-4,5-dihydroimidazolium tetrafluoroborate, min. 95% (282109-83-5) $C_{27}H_{39}N_2^+BF_4^-$; FW: 478.43; white powder. Note: NHC Ligand Kit 3: Variety of N-Heterocyclic Carbenes Kit component. For detailed technical note visit strem.com .	1g 5g
07-0593 HAZ	1,3-Bis(2,6-di-i-propylphenyl)-4,5-dihydroimidazol-2-ylidene, min. 98% (258278-28-3) $C_{27}H_{38}N_2$; FW: 390.60; white to off-white powder. <i>air sensitive, moisture sensitive, (store cold)</i> Note: NHC Ligand Kit 2: "Free" Carbenes Kit component.	500mg 2g
07-0484 NEW	1,3-Bis(2,6-di-i-propylphenyl)imidazolium bicarbonate, min. 97% IPr.H.CO ₃ (1663476-15-0) $[C_{27}H_{37}N_2]^+HCO_3^-$; FW: 450.61; white to off-white powder. <i>hygroscopic</i> For detailed technical note visit strem.com .	500mg 2g

NITROGEN (Compounds)

07-0590	1,3-Bis(2,6-di-i-propylphenyl) imidazolium chloride, min. 97% (250285-32-6) $C_{27}H_{37}N_2Cl$; FW: 425.06; white to off-white powdr. Note: NHC Ligand Kit 3: Variety of N-Heterocyclic Carbenes Kit component. For detailed technical note visit strem.com .		500mg 2g
07-0595	1,3-Bis(2,6-di-i-propylphenyl)imidazol-2-ylidene, min. 98% (244187-81-3) $C_{27}H_{36}N_2$; FW: 388.59; white to off-white powdr. <i>air sensitive, moisture sensitive</i> Note: NHC Ligand Kit 2: "Free" Carbenes Kit component. For detailed technical note visit strem.com .		250mg 1g
07-0285	2,3-Bis(2,6-di-i-propylphenylimino) butane, 98% (74663-77-7) $[(C_3H_7)_2C_6H_3-N=C(CH_3)_2]_2$; FW: 404.60; yellow xtl.; m.p. 104-106°		500mg 2g
Technical Note: 1. Ligand used in the preparation of highly active nickel and palladium catalysts for the polymerization of ethylene and α -olefins.			
References: 1. <i>J. Am. Chem. Soc.</i> , 1995 , <i>117</i> , 6414 2. <i>Angew. Chem. Int. Ed.</i> , 2001 , <i>40</i> , 534 3. <i>Organometallics</i> , 2003 , <i>22</i> , 24, 5033			
07-0289	2,6-Bis[1-(2,6-di-i-propylphenylimino)ethyl]pyridine, 98% (204203-14-5) $C_{33}H_{43}N_3$; FW: 481.69; pale yellow powdr.		500mg 2g
Technical Note: 1. Active ethylene polymerization catalyst with iron and cobalt.			
References: 1. <i>J. Am. Chem. Soc.</i> , 1998 , <i>120</i> , 4049 2. <i>Angew. Chem. Int. Ed.</i> , 2001 , <i>40</i> , 534			
07-4050 amp HAZ	1,3-Bis[2,6-di-i-propyl-4-[polyisobutyl(20)phenyl]imidazolium chloride (50% in hexanes/polyisobutylene) $C_{187}H_{359}N_2Cl$; FW: 2669; orange liq. For detailed technical note visit strem.com .		500mg
07-0291	2-{4,5-Bis[(6-(2-ethoxy-2-oxoethoxy)-2-methylquinolin-8-ylamino)methyl]-6-hydroxy-3-oxo-3H-xanthen-9-yl}benzoic acid FL2E (1239877-06-5) $C_{50}H_{44}N_4O_{11}$; FW: 876.30; dark-red solid (<i>store cold</i>) Note: Nitric Oxide Sensor (Intracellular) Kit ("NO-ON") (FL2) component.		0.5mg

NITROGEN (Compounds)

07-0287 NEW	2-{4,5-Bis[(6-(2-ethoxy-2-oxohydroxy)-2-methylquinolin-8-ylamino)methyl]-6-hydroxy-3-oxo-3H-xanthen-9-yl}benzoic acid FL2A (1239877-07-6) C ₄₆ H ₃₆ N ₂ O ₁₁ ; FW: 848.85; dark-red solid Note: Nitric Oxide Sensor (Extracellular) Kit ("NO-ON") (FL2) component.		0.5mg
07-0295	N,N' -Bis(2-hydroxybenzyl)ethylenediamine, min. 98% H ₄ SALEN (18653-98-0) C ₁₆ H ₂₀ N ₂ O ₂ ; FW: 272.35; off-white xtl.; m.p. 118-120°		5g 25g
07-6008	(1R,2R) -1,2-Bis(2-hydroxyphenyl)ethane-1,2-diamine, min. 97% (870991-70-1) C ₁₄ H ₁₆ N ₂ O ₂ ; FW: 244.29; white to off-white powdr. <i>air sensitive</i>		250mg 1g
07-6009	(1S,2S) -1,2-Bis(2-hydroxyphenyl)ethane-1,2-diamine, min. 97% (119386-71-9) C ₁₄ H ₁₆ N ₂ O ₂ ; FW: 244.29; white to off-white powdr. <i>air sensitive</i>		250mg 1g
07-0232	(1R,2R) -(-)-1,2-Bis(4-hydroxyphenyl)ethylenediamine dihydrochloride, min. 98% (1055301-14-8) C ₁₄ H ₁₆ N ₂ O ₂ ·2HCl; FW: 317.21; white to off-white powdr. <i>hygroscopic</i>		100mg 500mg
07-2203	1,4-Bis(2-isocyanopropyl)piperazine (SnatchCat Metal Scavenger) (51641-96-4) See page 128		
07-0210	(2R) -(+)-1,1-Bis(4-methoxyphenyl)-3-methyl-1,2-butanediamine, min. 97% (R)-DAIPEN (166764-19-8) C ₁₉ H ₂₆ N ₂ O ₂ ; FW: 314.43; white to pale yellow powdr.; m.p. 78-98°		50mg 250mg
07-0211	(2S) -(-)-1,1-Bis(4-methoxyphenyl)-3-methyl-1,2-butanediamine, min. 97% (S)-DAIPEN (148369-91-9) C ₁₉ H ₂₆ N ₂ O ₂ ; FW: 314.43; white to pale yellow powdr.; m.p. 78-98°		50mg 250mg

Technical Note:

- See 07-0210 (page 185)

NITROGEN (Compounds)

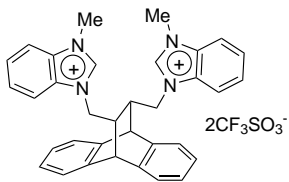
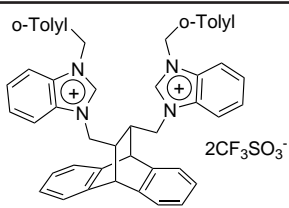
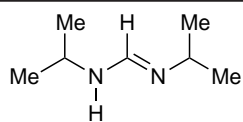
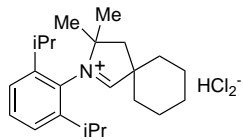
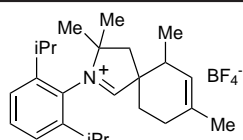
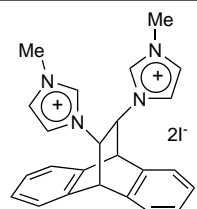
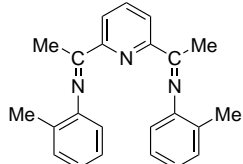
07-0080	<p>11,12-Bis[N-methyl-1H-benzimidazolium-3-methylene]-9,10-dihydro-9,10-ethanoanthracene bis(trifluoromethanesulfonate) (958004-03-0) $[C_{34}H_{32}N_4](CF_3SO_3)_2$; FW: 794.79; white to off-white powdr. Note: Sold under license from UFRFI for research purposes only. Patent application PCT/US2008/054137. NHC Ligand Kit 4: Bis Carbenes Kit component.</p>		100mg 500mg
07-0082	<p>11,12-Bis[N-(2-methylbenzyl)-1H-benzimidazolium-3-methylene]-9,10-dihydro-9,10-ethanoanthracene bis(trifluoromethanesulfonate), min. 95% $[C_{48}H_{44}N_4](CF_3SO_3)_2$; FW: 951.01; white to off-white powdr. Note: Sold under license from UFRFI for research purposes only. Patent application PCT/US2008/054137. NHC Ligand Kit 4: Bis Carbenes Kit component.</p>		100mg 500mg
07-0240	<p>N,N'-Bis(1-methylethyl)methanimidamide, min. 98% (44843-38-1) $C_7H_{16}N_2$; FW: 128.22; off-white powdr.</p>		1g 5g 25g
07-0550	<p>2-[2,6-Bis(1-methylethyl)phenyl]-3,3-dimethyl-2-azoniaspiro[4.5]dec-1-ene hydrogen dichloride, min. 97% Cyclohexyl-CAAC (1141464-90-5) $C_{23}H_{36}N \cdot HCl_2$; FW: 398.45; white powdr. <i>hygroscopic</i> Note: US Patent Application 11/449,568 and PCT Application US06/22477. For detailed technical note visit strem.com.</p>		100mg 500mg
07-0558	<p>2-[2,6-Bis(1-methylethyl)phenyl]-3,3,6,8-tetramethyl-2-azoniaspiro[4.5]dec-1,7-diene tetrafluoroborate Trivertal-CAAC (1160555-04-3) $C_{25}H_{38}BF_4N$; FW: 439.38; white powdr. <i>hygroscopic</i> Note: US Patent Application 11/449,568 and PCT Application US06/22477.</p>		100mg 500mg
07-0083	<p>11,12-Bis[3-methylimidazolium]-9,10-dihydro-9,10-ethanoanthracene bis(iodide), min. 95% $[C_{24}H_{24}N_4]_2$; FW: 622.28; white to off-white powdr. Note: Sold under license from UFRFI for research purposes only. Patent application PCT/US2008/054137. NHC Ligand Kit 4: Bis Carbenes Kit component.</p>		100mg 500mg
07-0296	<p>2,6-Bis[1-(2-methylphenylimino)ethyl]pyridine, 98% (210537-32-9) $C_5H_9N[(CH_3)C_6H_4N=C(CH_3)]_2$; FW: 341.46; yellow powdr.</p>		500mg 2g

Technical Note:

1. Active ethylene oligomerization catalyst with iron to give α -olefins.

References:

1. *J. Am. Chem. Soc.*, **1998**, *120*, 7143
2. *Angew. Chem. Int. Ed.*, **2001**, *40*, 534

NITROGEN (Compounds)

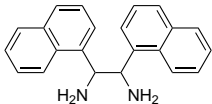
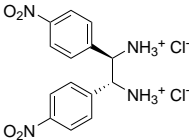
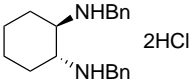
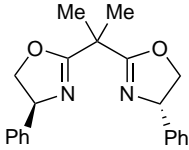
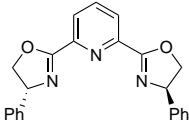
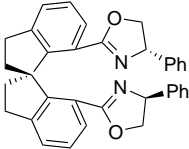
07-0492	meso-1,2-Bis(naphthyl)ethylenediamine, min. 98% (117106-39-5) C ₂₂ H ₂₀ N ₂ ; FW: 312.41; white to yellow pwdr. <i>air sensitive</i>		100mg 500mg
07-0243	(1R,2R)-(+)-1,2-Bis(4-nitrophenyl)ethylenediamine dihydrochloride, min. 98% (117903-79-4) C ₁₄ H ₁₄ N ₄ O ₄ ·2HCl; FW: 375.21; white to off-white pwdr. <i>hygroscopic</i>		100mg 500mg
07-4073	(1R,2R)-N,N'-Bis(phenylmethyl)-1,2-cyclohexanediamine dihydrochloride, min. 98% (212611-88-6) C ₂₀ H ₂₆ N ₂ ·2HCl; FW: 367.36; white to light-yellow pwdr. Note: Sold in collaboration with Daicel for research purposes only. For detailed technical note visit strem.com .		1g 5g
07-4074	(1S,2S)-N,N'-Bis(phenylmethyl)-1,2-cyclohexanediamine dihydrochloride, min. 98% C ₂₀ H ₂₆ N ₂ ·2HCl; FW: 367.36; white to light-yellow pwdr. Note: Sold in collaboration with Daicel for research purposes only.		1g 5g
Technical Note: 1. See 07-4073 (page 187)			
07-0275	(-)-2,2-Bis[(4R)-4-phenyl-2-oxazolin-2-yl]propane, 98% (131457-46-0) C ₂₁ H ₂₂ N ₂ O ₂ ; FW: 334.41; viscous liq. For detailed technical note visit strem.com .		250mg 1g
07-0303	(+)-2,6-Bis[(4R)-4-phenyl-2-oxazolin-2-yl]pyridine, 98+% (R,R)-Ph-pybox (128249-70-7) C ₂₃ H ₁₉ N ₃ O ₂ ; FW: 369.42; white xtl.; m.p. 171-175° For detailed technical note visit strem.com .		500mg 2g
07-0304	(-)-2,6-Bis[(4S)-4-phenyl-2-oxazolin-2-yl]pyridine, 98+% (S,S)-Ph-pybox (174500-20-0) C ₂₃ H ₁₉ N ₃ O ₂ ; FW: 369.42; white xtl.; m.p. 171-175°		500mg 2g
Technical Note: 1. See 07-0303 (page 187)			
07-5194	(R)-7,7'-Bis[(4S)-(phenyl)oxazol-2-yl]-2,2',3,3'-tetrahydro-1,1'-spirobiindane, min. 97% (Ra,S,S)-SpiroBOX (890090-21-8) C ₃₅ H ₃₀ N ₂ O ₂ ; FW: 510.62; white solid; m.p. 130-132° <i>moisture sensitive</i> For detailed technical note visit strem.com .		25mg 100mg
07-5195	(S)-7,7'-Bis[(4S)-(phenyl)oxazol-2-yl]-2,2',3,3'-tetrahydro-1,1'-spirobiindane, min. 97% (Sa,S,S)-SpiroBOX (940880-69-3) C ₃₅ H ₃₀ N ₂ O ₂ ; FW: 510.62; white solid; m.p. 167-169° <i>moisture sensitive</i> For detailed technical note visit strem.com .		25mg 100mg

NITROGEN (Compounds)

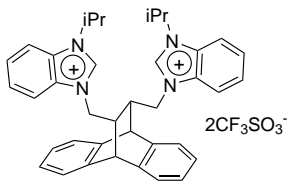
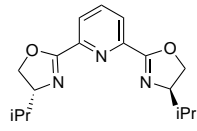
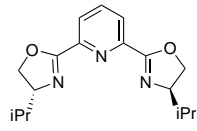
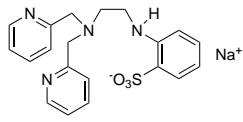
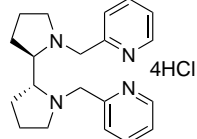
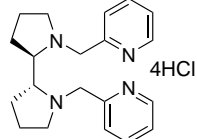
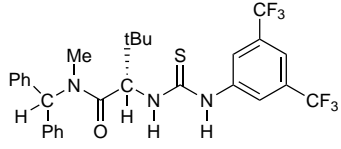
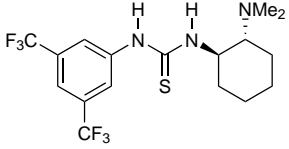
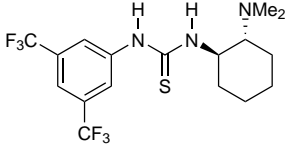
07-0084	<p>11,12-Bis([N-(i-propyl)-1H-benzimidazolium-3-methylene]-9,10-dihydro-9,10-ethanoanthracene bis(trifluoromethanesulfonate) (958004-12-1) $[C_{38}H_{40}N_4](CF_3SO_3)_2$; FW: 826.87; white to off-white powdr. Note: Sold under license from UFRFI for research purposes only. Patent application PCT/US2008/054137. NHC Ligand Kit 4: Bis Carbenes Kit component.</p>		100mg 500mg
07-0306	<p>(+)-2,6-Bis[(4R)-4-(i-propyl)-2-oxazolin-2-yl]pyridine, 98+% (R)-(i-Pr)-pybox (131864-67-0) $C_{17}H_{23}N_3O_2$; FW: 301.38; white xtl.; m.p. 152-153° For detailed technical note visit strem.com.</p>		250mg 1g
07-0307	<p>(-)-2,6-Bis[(4S)-4-(i-propyl)-2-oxazolin-2-yl]pyridine, 98+% (S)-(i-Pr)-pybox (118949-61-4) $C_{17}H_{23}N_3O_2$; FW: 301.38; white xtl.; m.p. 152-153° For detailed technical note visit strem.com.</p>		250mg 1g
07-0350	<p>2-[[Bis(2-pyridinylmethyl)amino]ethylamino] benzenesulfonic acid hydrate sodium salt ZX1 $C_{20}H_{21}N_4NaO_3S$; FW: 420.46; yellow solid <i>air sensitive</i></p>		100mg 500mg
07-0097	<p>(2R,2'R)-(+)-[N,N'-Bis(2-pyridylmethyl)]-2,2'-bipyrrolidine tetrahydrochloride, 98% (R,R)-PDP (1228077-88-0) $C_{20}H_{26}N_4 \cdot 4HCl$; FW: 468.29; white powdr. <i>air sensitive</i> Note: Patent pending.</p>		100mg 500mg
07-0094	<p>(2S,2'S)-(-)-[N,N'-Bis(2-pyridylmethyl)]-2,2'-bipyrrolidine tetrahydrochloride, 98% (S,S)-PDP (959395-07-4) $C_{20}H_{26}N_4 \cdot 4HCl$; FW: 468.29; white powdr. <i>air sensitive</i> Note: Patent pending.</p>		100mg 500mg
07-0215	<p>(2S)-(-)-2-[[[3,5-Bis(trifluoromethyl)phenyl]amino]thioxomethyl]amino]-N-(di-phenylmethyl)-N,3,3-trimethylbutanamide, 95% (1186602-28-7) $C_{29}H_{29}F_6N_3OS$; FW: 581.62; white to gray solid; m.p. 193-198° Note: US Patent Application 61/240,558.</p>		50mg 250mg 1g
07-0283	<p>1-[3,5-Bis(trifluoromethyl)phenyl]-3-[(1R,2R)-(-)-2-(dimethylamino)cyclohexyl]thiourea (R,R-TUC) (620960-26-1) $C_{17}H_{21}F_6N_3S$; FW: 413.42; white powdr.; m.p. 87-88° Note: Sold for research purposes only. Patents PCT Application No.: JP2004009350 (publication WO2005000803) US Application 10/562,579, EPC Application 04746819.4 For detailed technical note visit strem.com.</p>		250mg 1g
07-0284	<p>1-[3,5-Bis(trifluoromethyl)phenyl]-3-[(1S,2S)-(+)-2-(dimethylamino)cyclohexyl]thiourea (S,S-TUC) (851477-20-8) $C_{17}H_{21}F_6N_3S$; FW: 413.42; white powdr.; m.p. 87-88° Note: Sold for research purposes only. Patents PCT Application No.: JP2004009350 (publication WO2005000803) US Application 10/562,579, EPC Application 04746819.4</p>		250mg 1g

Technical Note:

- See 07-0283 (page 188)

NITROGEN (Compounds)

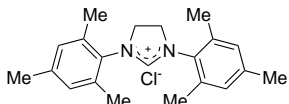
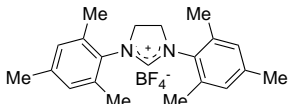
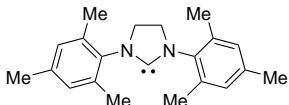
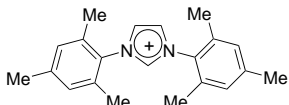
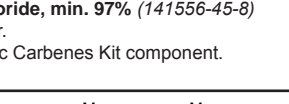
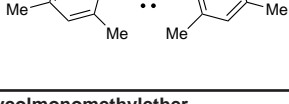
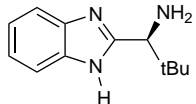
07-4011	1,3-Bis(2,4,6-trimethylphenyl)-4,5-dihydroimidazolium chloride, min. 97% (173035-10-4) $C_{21}H_{27}ClN_2$; FW: 342.91; white to off-white solid <i>air sensitive</i> Note: NHC Ligand Kit 3: Variety of N-Heterocyclic Carbenes Kit component.		500mg 2g
07-0302	1,3-Bis(2,4,6-trimethylphenyl)-4,5-dihydroimidazolium tetrafluoroborate, min. 95% SIMes-HBF₄ (245679-18-9) $[C_{21}H_{27}N_2]^+BF_4^-$; FW: 394.27; off-white powdr. Note: NHC Ligand Kit 3: Variety of N-Heterocyclic Carbenes Kit component. For detailed technical note visit strem.com .		1g 5g
07-0605 HAZ	1,3-Bis(2,4,6-trimethylphenyl)-4,5-dihydroimidazol-2-ylidene, min. 98% (173035-11-5) $C_{21}H_{26}N_2$; FW: 306.45; pale yellow powdr. <i>air sensitive, moisture sensitive</i> Note: NHC Ligand Kit 2: "Free" Carbenes Kit component. For detailed technical note visit strem.com .		500mg 2g
07-4033 NEW	1,3-Bis(2,4,6-trimethylphenyl)imidazolium bicarbonate, min. 97% IMesH.HCO₃ (1372124-93-0) $[C_{21}H_{26}N_2]^+HCO_3^-$; FW: 366.45; white to yellow-orange powdr. <i>moisture sensitive</i> For detailed technical note visit strem.com .		500mg 2g
07-0299	1,3-Bis(2,4,6-trimethylphenyl)imidazolium chloride, min. 97% (141556-45-8) $C_{21}H_{26}N_2Cl$; FW: 340.90; off-white to yellow powdr. Note: NHC Ligand Kit 3: Variety of N-Heterocyclic Carbenes Kit component. For detailed technical note visit strem.com .		1g 5g
07-0600 HAZ	1,3-Bis(2,4,6-trimethylphenyl)imidazol-2-ylidene, min. 98% (141556-42-5) $C_{21}H_{24}N_2$; FW: 304.43; white to off-white powdr. <i>air sensitive, moisture sensitive</i> Note: NHC Ligand Kit 2: "Free" Carbenes Kit component. For detailed technical note visit strem.com .		500mg 2g
07-0050	1-Butyl-2,3-dimethylimidazolium diethyleneglycolmonomethylether sulfate, 98% [BDiMIM] [MDEGSO₄] (108203-89-0) See page 81		
07-0060	1-Butyl-2,3-dimethylimidazolium octylsulfate, 98% [BDiMIM] [OcSO₄] (108203-89-0) See page 81		
07-0075	1-Butyl-2,3-dimethylimidazolium tetrafluoroborate, 98% [BDiMIM] [BF₄] (402846-78-0) See page 81		
06-0115	n-Butylisocyanide, 97% (2769-64-4) See page 38		
06-0120	t-Butylisocyanide, min. 98% (7188-38-7) See page 38		
07-1245	(S)-(-)-2-(α-(t-butyl)methanamine)-1H-benzimidazole, min. 95% (S)-t-Bu-BIMAH (1118114-88-7) $C_{12}H_{17}N_3$; FW: 203.28; white to off-white solid; m.p. 220-222° <i>air sensitive</i> Note: Sold under license from EnantioTech for research purposes only. PCT/CN2008/073648, CN 200810038929. EnantioTech BIMAH Ligand Kit component. For detailed technical note visit strem.com .		100mg 500mg

NITROGEN (Compounds)

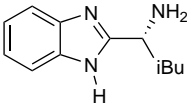
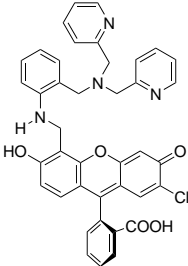
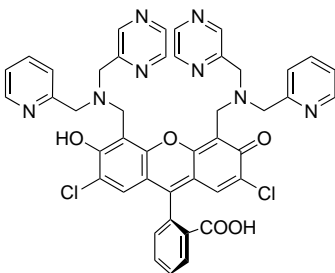
07-1242	<p>(R)-(+)-2-(α-(i-butyl)methanamine)-1H-benzimidazole, min. 98% (R)-i-Bu-BIMAH (1235960-36-7) $C_{12}H_{17}N_3$; FW: 203.28; white to off-white solid; m.p. 92-94° <i>air sensitive</i> Note: Sold under license from EnantioTech for research purposes only. PCT/CN2008/073648, CN 200810038929. EnantioTech BIMAH Ligand Kit component. For detailed technical note visit strem.com.</p>		100mg 500mg
07-1240	<p>(S)-(-)-2-(α-(i-butyl)methanamine)-1H-benzimidazole, min. 98% (S)-i-Bu-BIMAH (59592-31-3) $C_{12}H_{17}N_3$; FW: 203.28; white to off-white solid; m.p. 109-112° <i>air sensitive</i> Note: Sold under license from EnantioTech for research purposes only. PCT/CN2008/073648, CN 200810038929. EnantioTech BIMAH Ligand Kit component. For detailed technical note visit strem.com.</p>		250mg 1g
07-0100	<p>1-Butyl-3-methylimidazolium chloride, 98% [BMIM]Cl (79917-90-1) See page 81</p>		
07-0140	<p>1-Butyl-3-methylimidazolium methanesulfonate, 98% [BMIM] [MeSO₃] (401788-98-5) See page 81</p>		
07-0150	<p>1-Butyl-3-methylimidazolium octylsulfate, 98% [BMIM] [OctSO₄] (445473-58-5) See page 81</p>		
07-0160	<p>1-Butyl-3-methylimidazolium phosphate, 99% [BMIM]₃ [PO₄] (174501-65-6) See page 81</p>		
07-0170	<p>1-Butyl-3-methylimidazolium tetrafluoroborate, 98% [BMIM] [BF₄] (174501-65-6) See page 81</p>		
07-0180	<p>N-Butyl-3-methylpyridinium bis(trifluoromethylsulfonyl)imide, 99% [BMPIm] (344790-86-9) See page 82</p>		
07-0312	<p>9-(2-Carboxyphenyl)-2-chloro-5-[(2-(di(2-pyridyl)aminomethyl)phenyl)aminomethyl]-6-hydroxy-3-xanthone Zinpyr-4 (502467-23-4) $C_{40}H_{31}ClN_4O_5$; FW: 683.15; orange powdr.</p>		10mg
Technical Note:	1. An intracellular and extracellular Zn ²⁺ sensor of the Zinpyr family of ligands.		
References:	1. <i>J. Am. Chem. Soc.</i> , 2003 , <i>125</i> , 1778		
07-0311	<p>9-(2-Carboxyphenyl)-2,7-dichloro-4,5-bis[(2-picolyl)(pyrazin-2-ylmethyl)aminomethyl]-6-hydroxy-3-xanthone ZPP1 (1084898-23-6) $C_{44}H_{34}Cl_2N_8O_5$; FW: 825.70; pink powdr. For detailed technical note visit strem.com.</p>		0.5mg

NITROGEN (Compounds)

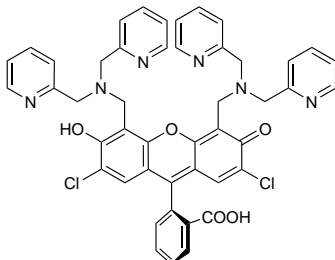
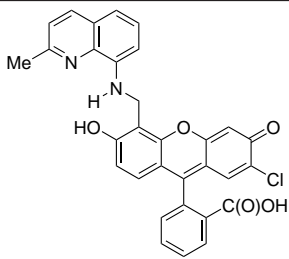
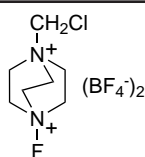
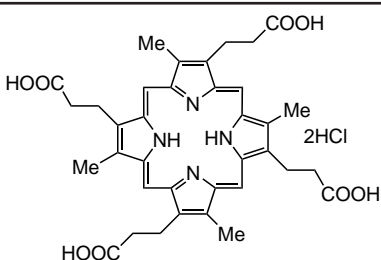
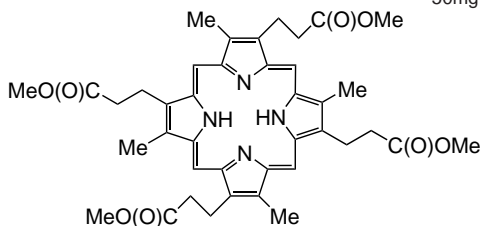
07-0314	9-(2-Carboxyphenyl)-2,7-dichloro-4,5-bis[di(2-pyridyl)aminomethyl]-6-hydroxy-3-xanthone ZINPYR-1 (288574-78-7) $C_{46}H_{36}Cl_2N_6O_5$; FW: 823.72; pink powdr. For detailed technical note visit strem.com .		10mg
07-0293	2-{2-Chloro-6-hydroxy-5-[2-methylquinolin-8-ylaminomethyl]-3-oxo-3H-xanthen-9-yl} benzoic acid FL (905982-78-7) $C_{31}H_{21}ClN_2O_5$; FW: 536.96; magenta solid (store cold) Note: Nitric Oxide Sensor (Intracellular Kit ("NO-ON") (FL) component. For detailed technical note visit strem.com .		0.5mg
07-0332	1-(Chloromethyl)-4-fluoro-1,4-diazoniabicyclo[2.2.2]octane bis(tetrafluoroborate), min. 97% SelectFluor® (140681-55-6) $(C_7H_{14}ClFN_2)(BF_4)_2$; FW: 354.26; white to off-white powdr. <i>moisture sensitive</i> For detailed technical note visit strem.com .		5g 25g 100g 500g
96-1575	Cinchona Alkaloid-Derived Organocatalyst Kit - (enantiopure primary amines) for Iminium-Enamine Activation <i>See page 478</i>		
07-0300	Coproporphyrin I dihydrochloride (synthetic) (69477-27-6) $C_{36}H_{38}N_4O_8 \cdot 2HCl$; FW: 727.64; purple xtl.		10mg 50mg
07-0310	Coproporphyrin I tetramethyl ester, 98% (synthetic) (25767-20-8) $C_{40}H_{46}N_4O_8$; FW: 710.83; purple xtl.; m.p. 251-252°		10mg 50mg

NITROGEN (Compounds)

07-0305 Coproporphyrin III dihydrochloride
(14643-66-4)
 $C_{38}H_{38}N_4O_8 \cdot 2HCl$; FW: 727.64; purple xtl.

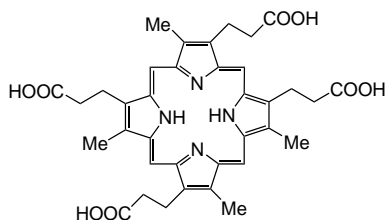

5mg
25mg

07-1310 Cucurbit[5]uril (CB[5]) ammonium sulfate hydrate, 99+% (259886-49-2)
 $C_{30}H_{30}N_{20}O_{10} \cdot (NH_4)_2SO_4 \cdot xH_2O$;
FW: 962.83; white solid
Note: Sold for R&D purposes only. US
6365734. Cucurbituril Kit component.

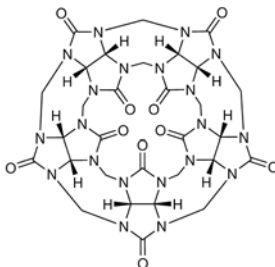

100mg

07-1320 Cucurbit[6]uril (CB[6]) hydrate, 99+% (80262-44-8)
 $C_{36}H_{36}N_{24}O_{12} \cdot xH_2O$; FW: 996.82; white solid
Note: Cucurbituril Kit component.

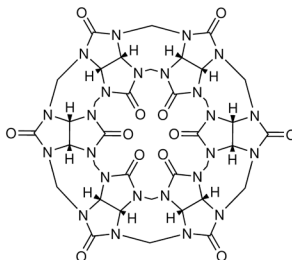

500mg

07-1325 Cucurbit[7]uril (CB[7]) hydrate, 99+% (259886-50-5)
 $C_{42}H_{42}N_{28}O_{14} \cdot xH_2O$; FW: 1162.96; white solid
Note: Sold for R&D purposes only. US
6365734. Cucurbituril Kit component.

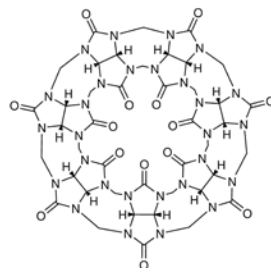

50mg

07-1330 Cucurbit[8]uril (CB[8]) hydrate, 99+% (259886-51-6)
 $C_{48}H_{48}N_{32}O_{16} \cdot H_2O$; FW: 1329.10; white solid
Note: Sold for R&D purposes only. US
6365734. Cucurbituril Kit component.

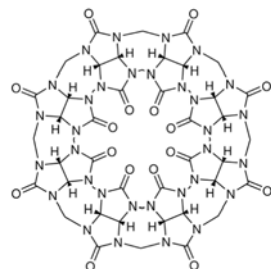

25mg

96-7054 Cucurbituril Kit
See page 539

NITROGEN (Compounds)

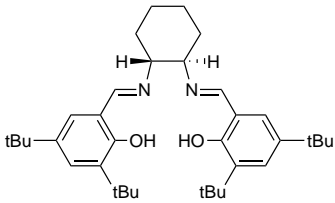
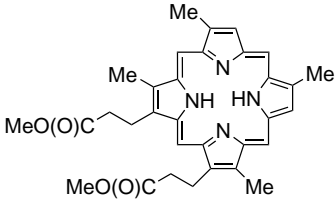
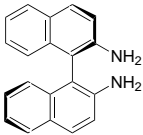
93-1001 HAZ 	Cyanogen bromide, min. 97% (506-68-3) BrCN; FW: 105.93; white xtl.; m.p. 52°; b.p. 61.4°; d. 2.015 <i>moisture sensitive, (store cold)</i>	25g 100g
07-0318	trans-1,2-Cyclohexanediaminetetraacetic acid monohydrate, min. 98% CyDTA (125572-95-4) (HOOCCH ₂) ₂ NC ₆ H ₁₀ N(CH ₂ COOH) ₂ ·H ₂ O; FW: 346.32 (364.36); white powdr.	25g 100g
07-0319	trans-1,2-Cyclohexanediaminetetraacetic acid monohydrate, 99+% CyDTA (125572-95-4) (HOOCCH ₂) ₂ NC ₆ H ₁₀ N(CH ₂ COOH) ₂ ·H ₂ O; FW: 346.32 (364.36); white xtl.	25g 100g
07-0316	(1R,2R)-(-)-1,2-Cyclohexanediamino-N,N'-bis(3,5-di-t-butylsalicylidene), 98% (R,R)-Jacobsen Ligand (135616-40-9) C ₃₆ H ₅₄ N ₂ O ₂ ; FW: 546.84; yellow powdr.; m.p. 205-207° For detailed technical note visit strem.com .	1g 5g
		
07-0317	(1S,2S)-(+)-1,2-Cyclohexanediamino-N,N'-bis(3,5-di-t-butylsalicylidene), 98% (S,S)-Jacobsen Ligand (135616-36-3) C ₃₆ H ₅₄ N ₂ O ₂ ; FW: 546.84; yellow powdr.; m.p. 205-207°	1g 5g
Technical Note: 1. See 07-0316 (page 193)		
07-0440	L-Cysteine ethyl ester hydrochloride, 98% (868-59-7) See page 167	
07-0325	Deuteroporphyrin IX, dimethyl ester, min. 97% (10589-94-3) C ₃₂ H ₃₄ N ₄ O ₄ ; FW: 538.65; purple xtl.; m.p. 227°	10mg 50mg
		
07-0326	racemic-2,2'-Diamino-1,1'-binaphthyl, min. 96% (4488-22-6) C ₂₀ H ₁₆ N ₂ ; FW: 284.36; white to off-white xtl.	1g 5g
07-0327	(R)-(+)-2,2'-Diamino-1,1'-binaphthyl, 99% (18741-85-0) C ₂₀ H ₁₆ N ₂ ; FW: 284.36; white to off-white xtl.; m.p. 242-244°	250mg 1g
		
07-0328	(S)-(-)-2,2'-Diamino-1,1'-binaphthyl, 99% (18531-95-8) C ₂₀ H ₁₆ N ₂ ; FW: 284.36; white to off-white xtl.; m.p. 242-244°	250mg 1g
07-0330 HAZ	(1R,2R)-(-)-1,2-Diaminocyclohexane, 99% (R,R)-DACH (20439-47-8) C ₆ H ₁₄ N ₂ ; FW: 114.19; white powdr.; m.p. 38-40°; b.p. 65°/5 mm; f.p. 169°F <i>air sensitive, light sensitive, (store cold)</i>	1g 5g
07-0335 HAZ	(1S,2S)-(+)-1,2-Diaminocyclohexane, 99% (S,S)-DACH (21436-03-3) C ₆ H ₁₄ N ₂ ; FW: 114.19; white powdr.; m.p. 38-40°; b.p. 65°/5 mm; f.p. 169°F <i>air sensitive, light sensitive, (store cold)</i>	1g 5g
15-0961	(1S,2S)-(-)-1,2-Diaminocyclohexane-N,N'-bis(2'-diphenylphosphinobenzoyl), 95% (S,S)-DACH-Phenyl Trost Ligand (169689-05-8) See page 285	
15-0960	(1R,2R)-(+)-1,2-Diaminocyclohexane-N,N'-bis(2'-diphenylphosphinobenzoyl), 98% (R,R)-DACH-Phenyl Trost Ligand (138517-61-0) See page 285	

NITROGEN (Compounds)

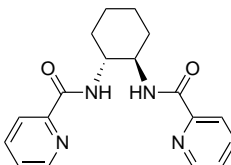
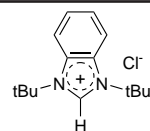
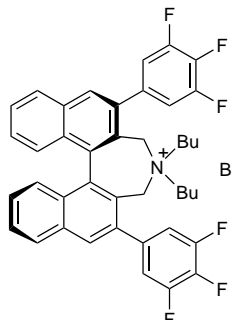
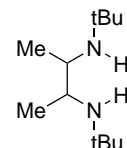
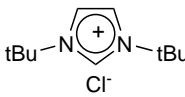
15-0963	(1R,2R)-(+)-1,2-Diaminocyclohexane-N,N'-bis(2-diphenylphosphino-1-naphthoyl), min. 94% (R,R)-DACH-Naphthyl Trost Ligand (174810-09-4) See page 285		
15-0964	(1S,2S)-(-)-1,2-Diaminocyclohexane-N,N'-bis(2-diphenylphosphino-1-naphthoyl), min. 94% (S,S)-DACH-Naphthyl Trost Ligand (205495-66-5) See page 285		
07-0340	(-)-N,N'-(1R,2R)-1,2-Diaminocyclohexanediyl-bis(2-pyridinecarboxamide), min. 98% (R,R)-DACH-Pyridyl Trost Ligand (218290-24-5) C ₁₈ H ₂₀ N ₄ O ₂ ; FW: 324.38; off-white powdr.; m.p. 170° For detailed technical note visit strem.com.		1g 5g
07-0341	(+)-N,N'-(1S,2S)-1,2-Diaminocyclohexanediylbis(2-pyridinecarboxamide), min. 98% (S,S)-DACH-Pyridyl Trost Ligand (172138-95-3) C ₁₈ H ₂₀ N ₄ O ₂ ; FW: 324.38; off-white powdr.; m.p. 170°		1g 5g
Technical Note: 1. See 07-0340 (page 194)			
07-4013	1,3-Di-t-butylimidazolium chloride, min. 97% (946607-10-9) C ₁₅ H ₂₃ ClN ₂ ; FW: 266.81; white to off-white solid <i>air sensitive</i>		500mg 2g
07-0380	(11bR)-4,4-Dibutyl-2,6-bis(3,4,5-trifluorophenyl)-4,5-dihydro-3H-dinaphtho[2,1-c:1',2'-e]azepinium bromide (887938-70-7) [C ₄₂ H ₃₈ F ₆ N] ⁺ Br ⁻ ; FW: 748.64; brown powdr. Note: Sold in collaboration with Nagase for research purposes only. US Patent 6,340,753. For detailed technical note visit strem.com.		50mg 250mg
07-0381	(11bS)-4,4-Dibutyl-2,6-bis(3,4,5-trifluorophenyl)-4,5-dihydro-3H-dinaphtho[2,1-c:1',2'-e]azepinium bromide (851942-89-7) [C ₄₂ H ₃₈ F ₆ N] ⁺ Br ⁻ ; FW: 748.64; brown powdr. Note: Sold in collaboration with Nagase for research purposes only. US Patent 6,340,753.		50mg 250mg
Technical Note: 1. See 07-0380 (page 194)			
07-0385	N,N'-Di-t-butyl-2,3-diaminobutane, 98% (1167987-07-6) (C ₄ H ₉)NHCH(CH ₃)CH(CH ₃)NH(C ₄ H ₉); FW: 200.36; colorless, viscous liq.; b.p. 224-232°; f.p. 80-100°F; d. 0.82 <i>air sensitive</i>		500mg 2g
07-0368	1,3-Di-t-butylimidazolium chloride, min. 98% (157197-54-1) [C ₁₁ H ₂₁ N ₂] ⁺ Cl ⁻ ; FW: 216.75; white xtl. <i>air sensitive, hygroscopic</i> Note: NHC Ligand Kit 3: Variety of N-Heterocyclic Carbenes Kit component.		250mg

NITROGEN (Compounds)

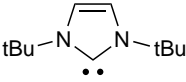
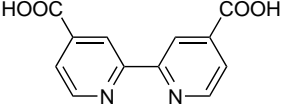
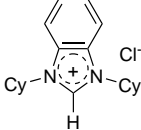
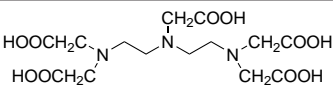
07-0333 HAZ	1,3-Di-t-butylimidazol-2-ylidene, min. 98% (157197-53-0) C ₁₁ H ₂₀ N ₂ ; FW: 180.29; white xtl.; m.p. 71-72° <i>air sensitive, moisture sensitive, (store cold)</i> Note: NHC Ligand Kit 2: "Free" Carbenes Kit component.		250mg
15-0073	2-(Di-t-butylphosphinomethyl)-6-(diethylaminomethyl)pyridine, 98% (863971-66-8) See page 289		
07-0370	4,4'-Dicarboxy-2,2'-bipyridine, 98% (6813-38-3) C ₁₂ H ₈ N ₂ O ₄ ; FW: 244.21; white pwdr.		250mg 1g 5g
07-1813	2,6-Dichloro-1-fluoropyridinium triflate, 95% (130433-68-0) C ₆ H ₃ Cl ₂ F ₄ NO ₃ S; FW: 316.06; white to light-yellow pwdr. <i>moisture sensitive, (store cold)</i>		500mg 2g
07-1813 NEW	2,6-Dichloro-1-fluoropyridinium triflate, 95% (130433-68-0) C ₆ H ₃ Cl ₂ F ₄ NO ₃ S; FW: 316.06; white to light-yellow pwdr. <i>air sensitive, moisture sensitive, (store cold)</i>		500mg 2g
07-4015	1,3-Dicyclohexylbenzimidazolium chloride, min. 97% (1034449-15-4) C ₁₈ H ₂₇ ClN ₂ ; FW: 318.88; white to off-white solid <i>air sensitive</i>		500mg 2g
15-1086	2-(Dicyclohexylphosphino)-N,N-bis(1-methylethyl)-1H-indole-1-carboxamide, min. 98% Amidole-Phos (1067175-36-3) See page 292		
15-1087	1-(Dicyclohexylphosphino)-2-(2-methoxyphenyl)-1H-indole, min. 98% NPCy o-Andole-Phos (947402-60-0) See page 294		
15-1089	1-(Dicyclohexylphosphino)-2-phenyl-1H-indole, min. 98% NPCy Phendole-Phos (947402-57-5) See page 295		
15-1088	2-[2-(Dicyclohexylphosphino)phenyl]-1-methyl-1H-indole, min. 98% CM-Phos (1067883-58-2) See page 295		
07-1677	Didodecylamine, min. 97% (3007-31-6) See page 167		
07-0400 HAZ	Diethylenetriamine, min. 95% DIEN (111-40-0) NH ₂ CH ₂ CH ₂ NHCH ₂ CH ₂ NH ₂ ; FW: 103.17; colorless liq.; m.p. -35°; b.p. 199-209°; f.p. 215°F; d. 0.955 <i>air sensitive</i>		100g 500g
07-0410	Diethylenetriaminepentaacetic acid, 97% DTPA (67-43-6) (HO ₂ CH ₂) ₂ N(CH ₂) ₂ N(CH ₂ CO ₂ H) (CH ₂) ₂ N(CH ₂ CO ₂ H) ₂ ; FW: 393.35; white xtl.; m.p. 220° dec.		250g 1kg
07-0398	Diethylenetriaminepentaacetic acid, 98.5% DTPA (USP) (67-43-6) (HO ₂ CCH ₂) ₂ N(CH ₂) ₂ N(CH ₂ CO ₂ H)(CH ₂) ₂ N(CH ₂ CO ₂ H) ₂ ; FW: 393.35; white xtl.; m.p. 220°		50g 250g
07-0412	Diethylenetriaminepentaacetic acid, 99% DTPA (67-43-6) (HO ₂ CCH ₂) ₂ N(CH ₂) ₂ N(CH ₂ CO ₂ H)(CH ₂) ₂ N(CH ₂ CO ₂ H) ₂ ; FW: 393.35; white xtl.; m.p. 220°		25g 100g

NITROGEN (Compounds)

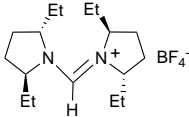
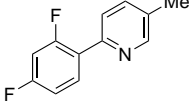
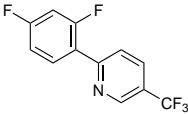
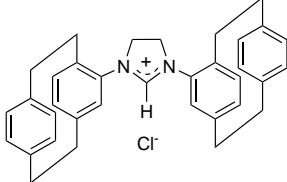
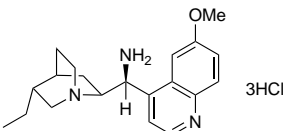
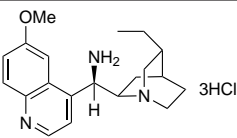
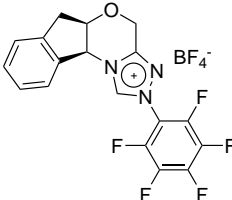
07-4024	(2R,5R)-1-[[[(2R,5R)-2,5-Diethylpyrrolidin-1-yl]methylene]-2,5-diethylpyrrolidinium tetrafluoroborate, min. 97% (1204324-20-8) C ₁₇ H ₃₃ BF ₄ N ₂ ; FW: 352.26; yellow solid <i>air sensitive</i> Note: Sold under license from Kanata for research purposes only. WO2010/003226. NHC Ligand Kit 1: Chiral N-Heterocyclic Carbenes Kit component.		100mg 500mg
07-4025	(2S,5S)-1-[[[(2S,5S)-2,5-Diethylpyrrolidin-1-yl]methylene]-2,5-diethylpyrrolidinium tetrafluoroborate, min. 97% (1204324-18-4) C ₁₇ H ₃₃ BF ₄ N ₂ ; FW: 352.26; yellow solid <i>air sensitive</i> Note: Sold under license from Kanata for research purposes only. WO2010/003226. NHC Ligand Kit 1: Chiral N-Heterocyclic Carbenes Kit component.		100mg 500mg
07-1280 NEW	2-(2,4-Difluorophenyl)-5-methylpyridine, 95% (583052-21-5) C ₁₂ H ₈ F ₂ N; FW: 205.20; white solid <i>air sensitive</i> Note: Ligand for photocatalyst synthesis.		500mg 2g
07-4040 NEW	2-(2,4-Difluorophenyl)-5-(trifluoromethyl)pyridine, 98% d(CF ₃)ppy (387827-64-7) C ₁₂ H ₆ F ₅ N; FW: 259.18; off-white microxtl.; m.p. 59.0-62.1°		250mg 1g
07-4018	(S)-4,5-Dihydro-1,3-bis-([2.2]paracyclophan-4-yl)imidazolinium chloride, min. 97% C ₃₅ H ₃₅ ClN ₂ ; FW: 519.12; white to tan-colored solid <i>air sensitive</i>		100mg 500mg
07-1718	(8α, 9S)-10,11-Dihydro-6'-methoxycinchonan-9-amine trihydrochloride, min. 90% (852913-53-2) C ₂₀ H ₂₇ N ₃ O·3HCl; FW: 434.83; white to off-white powdr. <i>(store cold)</i> For detailed technical note visit strem.com .		100mg 500mg
07-1722	(9R)-10,11-Dihydro-6'-methoxycinchonan-9-amine trihydrochloride, min. 90% (931098-92-9) C ₂₀ H ₂₇ N ₃ O·3HCl; FW: 434.83; white to off-white powdr. <i>(store cold)</i> For detailed technical note visit strem.com .		100mg 500mg
07-0415	(5aR,10bS)-(+)-5a,10b-Dihydro-2-(pentafluorophenyl)-4H,6H-indeno[2,1-b][1,2,4]triazolo[4,3-d][1,4]oxazinium tetrafluoroborate, min. 98% (872143-57-2) [C ₁₈ H ₁₁ F ₅ N ₃ O] ⁺ BF ₄ ⁻ ; FW: 467.10; light brown powdr. For detailed technical note visit strem.com .		250mg 1g

NITROGEN (Compounds)

07-0414	(5aS, 10bR)-(-)-5a,10b-Dihydro-2-(pentafluorophenyl)-4H,6H-indeno[2,1-b][1,2,4]triazolo[4,3-d][1,4]oxazinium tetrafluoroborate, min. 98% (740816-14-2) [C ₁₈ H ₁₁ F ₉ N ₃ O] ⁺ BF ₄ ⁻ ; FW: 467.10; light brown powdr.	100mg 500mg
Technical Note: 1. See 07-0415 (page 196)		
07-0417	6,7-Dihydro-2-pentafluorophenyl-5H-pyrrolo[2,1-c]-1,2,4-triazolium tetrafluoroborate, min. 98% (862095-91-8) [C ₁₁ H ₇ F ₅ N ₃] ⁺ BF ₄ ⁻ ; FW: 362.99; tan powdr. For detailed technical note visit strem.com.	250mg 1g
07-0421	6,7-Dihydro-2-phenyl-5H-pyrrolo[2,1-c]-1,2,4-triazolium chloride, min. 98% (828914-68-7) [C ₁₁ H ₁₂ N ₃] ⁺ Cl ⁻ ; FW: 221.69; off-white powdr. For detailed technical note visit strem.com.	250mg 1g
07-0496 NEW	(2R,3S)-(-)-3,4-Dihydro-3-(i-propyl)-2-phenyl-2H-pyrimido[2,1-b]benzothiazole, min. 98% HyperBTM (1203507-02-1) C ₁₉ H ₂₀ N ₂ S; FW: 308.44; white powdr.	100mg 500mg
07-0422	N,N'-Di(2-hydroxybenzyl)ethylenediamine-N,N'-diacetic acid monohydrochloride hydrate HBED (35369-53-0) C ₂₀ H ₂₄ N ₂ O ₆ ·HCl·XH ₂ O; FW: 424.89; off-white powdr.; m.p. 130-134°	1g 5g
07-1923 NEW HAZ	4,7-Dimethoxy-1,10-phenanthroline, 98% (92149-07-0) C ₁₄ H ₁₀ N ₂ O ₂ ; FW: 238.24; white to off-white powdr.; m.p. 210-212°; d. 1.25 <i>air sensitive</i> Note: Ligand for photocatalyst synthesis.	250mg 1g
05-0750	N,N-Dimethylanilinium tetra(pentafluorophenyl)borate, 98% (118612-00-3) See page 27	
07-0458 NEW	4,4'-Dimethyl-2,2'-bipyridine, 99% DMBPY (1134-35-6) C ₁₂ H ₁₂ N ₂ ; FW: 184.24; white to off-white powdr.	1g 5g 25g
07-0270	trans-N,N'-Dimethyl-1,2-cyclohexanediamine, 98% (67579-81-1) C ₆ H ₁₀ (NHCH ₃) ₂ ; FW: 142.24; colorless to pale yellow liq.; m.p. 4° <i>air sensitive</i> For detailed technical note visit strem.com.	500mg 2g 10g
07-0445 HAZ	N,N'-Dimethylethylenediamine, min. 98% (110-70-3) CH ₃ NHCH ₂ CH ₂ NHCH ₃ ; FW: 88.15; colorless liq.; b.p. 119°; d. 0.819 <i>air sensitive</i>	5g 25g 100g
07-4035	1,3-Dimethylimidazol-2-ylidene borane, min. 97% (1211417-77-4) C ₅ H ₇ BN ₂ ; FW: 109.97; white solid <i>moisture sensitive</i>	250mg 1g
07-0377	N-3-[(2,6-Dimethylphenyl)amino]-1-methyl-2-buten-1-ylidene)-2,6-dimethylbenzenamine, 98% (267431-79-8) C ₂₁ H ₂₆ N ₂ ; FW: 306.45; light-brown solid	250mg 1g

NITROGEN (Compounds)

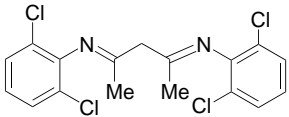
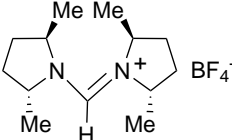
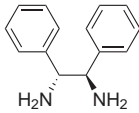
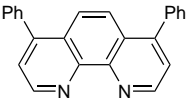
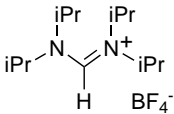
07-0375	N,N'-(1,3-Dimethyl-1,3-propanediylidene) bis(2,6-dichlorobenzamide), 99% (445460-78-6) C ₁₇ H ₁₄ Cl ₄ N ₂ ; FW: 388.12; white powdr.		1g 5g
07-0465	1,2-Dimethyl-3-propylimidazolium bis(trifluoromethylsulfonyl)imide, 99% [DMPIm] (169051-76-7) See page 82		
07-0470	1,2-Dimethyl-3-propylimidazolium tris(trifluoromethylsulfonyl)methide, 99% [DMPIMe] (169051-77-8) See page 82		
07-4022	(2R,5R)-1-[[[(2R,5R)-2,5-Dimethylpyrrolidin-1-yl]methylene]-2,5-dimethylpyrrolidinium tetrafluoroborate, min. 97% (1204324-14-0) C ₁₃ H ₂₅ BF ₄ N ₂ ; FW: 296.16; yellow solid <i>air sensitive</i> Note: Sold under license from Kanata for research purposes only. WO2010/003226. NHC Ligand Kit 1: Chiral N-Heterocyclic Carbenes Kit component.		100mg 500mg
07-0474	(1R,2R)-(+)-1,2-Diphenylethylenediamine, min. 97% (R,R)-DPEN (35132-20-8) (C ₆ H ₅) ₂ (NH ₂)CHCH(NH ₂)(C ₆ H ₅); FW: 212.29; white to pale yellow xtl.; m.p. 85-87°		500mg 2g 10g
07-0475	(1S,2S)-(-)-1,2-Diphenylethylenediamine, min. 97% (S,S)-DPEN (29841-69-8) (C ₆ H ₅) ₂ (NH ₂)CHCH(NH ₂)(C ₆ H ₅); FW: 212.29; white to pale yellow xtl.; m.p. 85-87°		500mg 2g 10g
07-0472	4,7-Diphenyl-1,10-phenanthroline, 99% (Bathophenanthroline) (1662-01-7) C ₂₄ H ₁₆ N ₂ ; FW: 332.40; off-white powdr.; m.p. 218° For detailed technical note visit strem.com.		250mg 1g 5g 25g
15-7220	(2R,4R)-(+)-2-(Diphenylphosphinomethyl)-4-(dicyclohexylphosphino)-N-(t-butoxycarbonyl)pyrrolidine, min. 97% (R,R-BCPM) (114751-47-2) See page 305		
15-7224	(2R,4R)-(+)-2-(Diphenylphosphinomethyl)-4-(dicyclohexylphosphino)-N-methyl-1-pyrrolidinecarboxamide, min. 95% (R,R-MCCPM) (122709-72-2) See page 305		
15-7225	(2S,4S)-(-)-2-(Diphenylphosphinomethyl)-4-(dicyclohexylphosphino)-N-methyl-1-pyrrolidinecarboxamide, min. 97% (S,S-MCCPM) (112521-97-8) See page 306		
15-7211	(2S,4S)-(-)-2-(Diphenylphosphinomethyl)-4-(diphenylphosphino) pyrrolidine, min. 97% (S,S-PPM) (61478-29-3) See page 306		
15-7210	(2R,4R)-(+)-2-(Diphenylphosphinomethyl)-4-(diphenylphosphino) pyrrolidine, min. 97% (R,R-PPM) (77450-05-6) See page 306		
15-7216	(2R,4R)-(+)-2-(Diphenylphosphinomethyl)-4-(diphenylphosphino)-N-(t-butoxycarbonyl)pyrrolidine, min. 97% (R,R-BPPM) (72598-03-9) See page 306		
15-7217	(2S,4S)-(-)-2-(Diphenylphosphinomethyl)-4-(diphenylphosphino)-N-(t-butoxycarbonyl)pyrrolidine, min. 97% (S,S-BPPM) (61478-28-2) See page 306		
07-4020	Di-i-propylaminomethylene(di-i-propyl)aminium tetrafluoroborate, min. 97% (369405-27-6) C ₁₃ H ₂₉ BF ₄ N ₂ ; FW: 300.19; white solid <i>air sensitive</i>		500mg 2g

NITROGEN (Compounds)

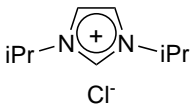
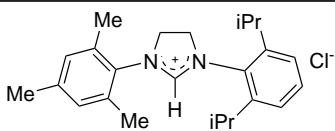
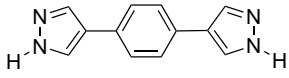
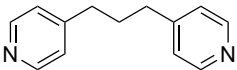
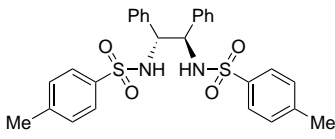
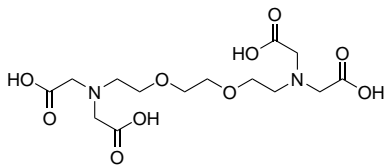
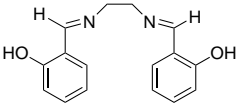
07-0485	1,3-Di-i-propylimidazolium chloride, min. 97% (139143-09-2) [C ₉ H ₁₇ N ₂] ⁺ Cl ⁻ ; FW: 188.70; white to off-white xtl. <i>air sensitive, hygroscopic</i>		1g 5g
07-4017	1-(2,6-Di-i-propylphenyl)-3-(2,4,6-trimethylphenyl)-4,5-dihydroimidazolium chloride, min. 97% (866926-59-2) C ₂₄ H ₃₃ ClN ₂ ; FW: 384.99; white to pink solid <i>air sensitive</i>		500mg 2g
07-0435	1,4-Di(4'-pyrazolyl)benzene, min. 97% H₂BDP (1036248-62-0) C ₁₂ H ₁₀ N ₄ ; FW: 210.24; pale yellow solid Note: Ligand for MOF synthesis.		500mg 2g
07-0510	1,3-Di-(4-pyridyl)propane, 98% (17252-51-6) C ₁₃ H ₁₄ N ₂ ; FW: 198.26; light yellow xtl.		5g 25g
07-4060	(1R,2R)-N,N'-Di-p-tosyl-1,2-diphenyl-1,2-ethylenediamine, min. 98% (121758-19-8) C ₂₈ H ₂₈ N ₂ O ₄ S ₂ ; FW: 520.67; white to light-yellow powdr. Note: Sold in collaboration with Daicel for research purposes only. For detailed technical note visit strem.com .		500mg 1g
07-4061	(1S,2S)-N,N'-Di-p-tosyl-1,2-diphenyl-1,2-ethylenediamine, min. 98% (170709-41-8) C ₂₈ H ₂₈ N ₂ O ₄ S ₂ ; FW: 520.67; white to light-yellow powdr. Note: Sold in collaboration with Daicel for research purposes only.		500mg 1g
Technical Note: 1. See 07-4060 (page 199)			
96-3700	Enantiotech BIMAH Ligand Kit for Asymmetric Hydrogenation See page 510		
07-0535	1-Ethyl-2,3-dimethylimidazolium tosylate, 98% [EDiMIM] [TOS] (783321-71-1) See page 82		
07-0610	Ethylene glycol-bis(2-aminoethyl)-N,N,N',N'-tetraacetic acid, 99% EGTA (67-42-5) (HOOCCH ₂) ₂ N(CH ₂ CH ₂ O) ₂ CH ₂ CH ₂ N(CH ₂ COOH) ₂ ; FW: 380.35; white xtl.		25g 100g
07-0540	Ethylenebis(salicylimine), 98% SALEN (94-93-9) HOC ₆ H ₄ CH=NCH ₂ CH ₂ N=CHC ₆ H ₄ OH; FW: 268.32; yellow xtl.; m.p. 122-125°		25g 100g
07-0570	Ethylenediamine, 99% (107-15-3) HAZ NH ₂ CH ₂ CH ₂ NH ₂ ; FW: 60.10; colorless to pale yellow liq.; m.p. 8.5°; b.p. 118°; f.p. 93°F; d. 0.899 <i>air sensitive</i>		250g 1kg
07-0573	Ethylenediaminetetraacetic acid, 99+% (60-00-4) (HO ₂ CCH ₂) ₂ NCH ₂ CH ₂ N(CH ₂ CO ₂ H) ₂ ; FW: 292.24; white xtl.; m.p. 245° dec.		500g 2kg
07-0580	Ethylenediaminetetraacetic acid dipotassium salt dihydrate, 99% (25102-12-9) (HOOCCH ₂) ₂ NCH ₂ CH ₂ N(CH ₂ COOK) ₂ ·2H ₂ O; FW: 368.44 (404.47); white xtl.; m.p. 272° dec.		50g 250g
93-1103	Ethylenediaminetetraacetic acid, disodium salt, dihydrate, 99+% (6381-92-6) (HOOCCH ₂) ₂ NCH ₂ CH ₂ N(CH ₂ COONa) ₂ ·2H ₂ O; FW: 336.22 (372.24); white xtl.; m.p. 255°		250g 1kg

NITROGEN (Compounds)

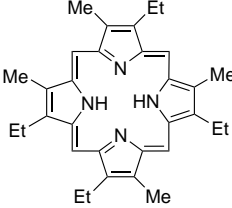
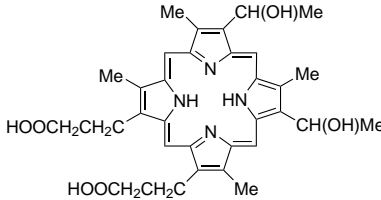
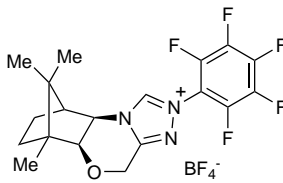
93-1104	Ethylenediaminetetraacetic acid, tetrasodium salt tetrahydrate, 99+% (64-02-8) (NaOOCCH ₂) ₂ NCH ₂ CH ₂ N(CH ₂ COONa) ₂ ·4H ₂ O; FW: 380.18 (452.23); white xtl.	500g 2kg
07-0578	1-Ethyl-3-methylimidazolium bis(pentafluoroethylsulfonyl)imide, 99% [EMIBeti] (216299-76-2) See page 82	
07-0579	1-Ethyl-3-methylimidazolium bis(trifluoromethylsulfonyl)imide, 99% [EMIlm] (174899-82-2) See page 82	
07-0581	1-Ethyl-3-methylimidazolium ethylsulfate, 98% (342573-75-5) See page 82	
07-0588	1-Ethyl-3-methylimidazolium tosylate, 98% [EMIM] [TOS] (328090-25-1) See page 82	
07-0585	Etioporphyrin III (26608-34-4) C ₃₂ H ₃₈ N ₄ ; FW: 478.68; purple xtl.	50mg 250mg
		
07-1828	1-Fluoropyridinium triflate, 95% (107263-95-6) C ₆ H ₅ F ₄ NO ₃ S; FW: 247.17; white to pale-yellow powdr. <i>moisture sensitive, (store cold)</i>	500mg 2g
07-1828	1-Fluoropyridinium triflate, 95% (107263-95-6) C ₆ H ₅ F ₄ NO ₃ S; FW: 247.17; white to pale-yellow powdr. <i>air sensitive, moisture sensitive, (store cold)</i>	500mg 2g
	NEW	
07-1835	1-Fluoro-2,4,6-trimethylpyridinium triflate (107264-00-6) C ₉ H ₁₁ F ₄ NO ₃ S; FW: 289.25; white to pale-yellow powdr. <i>moisture sensitive, (store cold)</i>	500mg 2g
07-1835	1-Fluoro-2,4,6-trimethylpyridinium triflate (107264-00-6) C ₉ H ₁₁ F ₄ NO ₃ S; FW: 289.25; white to pale-yellow powdr. <i>air sensitive, moisture sensitive, (store cold)</i>	500mg 2g
	NEW	
07-0790	Hematoporphyrin IX dihydrochloride (17696-69-4) C ₃₄ H ₃₈ N ₄ O ₆ ·2HCl; FW: 671.62; purple xtl.	1g 5g
		
07-0970	(5aS,6R,9S,9aR)-5a,6,7,8,9,9a-Hexahydro-6,11,11-trimethyl-2-(2,3,4,5,6-pentafluorophenyl)-6,9-methano-4H-[1,2,4]triazolo[3,4-c][1,4]benzoxazinium tetrafluoroborate (1037287-81-2) C ₁₉ H ₁₉ F ₅ N ₃ OBF ₄ ; FW: 487.17; white powdr. <i>hygroscopic</i> Note: Sold in collaboration with SIOC for research purposes only. Patent ZL200810033107.0. For detailed technical note visit strem.com .	250mg 1g
		

NITROGEN (Compounds)

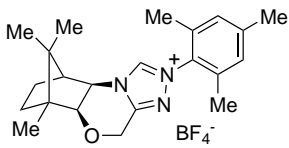
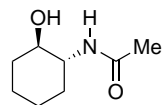
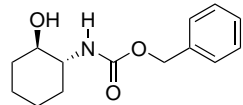
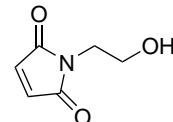
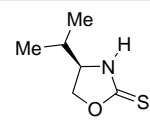
07-0975	(5aS,6R,9S,9aR)-5a,6,7,8,9,9a-Hexahydro-6,11,11-trimethyl-2-(2,4,6-trimethylphenyl)-6,9-methano-4H-[1,2,4]triazolo[3,4-c][1,4]benzoxazinium tetrafluoroborate (1037287-79-8) C ₂₂ H ₃₀ N ₃ OBF ₄ ; FW: 439.29; white to off-white powdr. <i>hygroscopic</i> Note: Sold in collaboration with SI-OC for research purposes only. Patent ZL200810033107.0. For detailed technical note visit strem.com .		250mg 1g
07-0968	1-Hexyl-3-methylimidazolium tetrafluoroborate, 98% [HMIM] [BF₄] (244193-50-8) See page 82		
07-0785	N-[(1R,2R)-2-Hydroxycyclohexyl]acetamide, min. 98% (214348-95-5) C ₈ H ₁₅ NO ₂ ; FW: 157.21; white to light-yellow powdr. Note: Sold in collaboration with Daicel for research purposes only.		1g 5g
07-0786	N-[(1S,2S)-2-Hydroxycyclohexyl]acetamide, min. 98% (190848-36-3) C ₈ H ₁₅ NO ₂ ; FW: 157.21; white to light-yellow powdr. Note: Sold in collaboration with Daicel for research purposes only.		1g 5g
07-1005	[(1R,2R)-2-Hydroxycyclohexyl]carbamic Acid Phenylmethyl Ester, min. 98% (134108-76-2) C ₁₄ H ₁₉ NO ₃ ; FW: 249.31; white to light-yellow powdr. Note: Sold in collaboration with Daicel for research purposes only.		1g 5g
07-1006	[(1S,2S)-2-Hydroxycyclohexyl]carbamic Acid Phenylmethyl Ester, min. 98% (198422-64-9) C ₁₄ H ₁₉ NO ₃ ; FW: 249.31; white to light-yellow powdr. Note: Sold in collaboration with Daicel for research purposes only.		1g 5g
07-1010	N-(2-Hydroxyethyl)maleimide, 99% (1585-90-6) C ₆ H ₇ NO ₃ ; FW: 141.13; white powdr.		250mg 1g
96-6510	Ionic Liquid Kit 2: BMIM Kit See page 499		
96-6520	Ionic Liquid Kit 3: CYPHOS® IL Phosphonium Salt Kit See page 499		
96-6500	Ionic Liquid Kit 1: Hydrophobic (water-immiscible) Kit See page 498		
07-0615	(R)-4-Isopropyl-2-oxazolidinethione, min. 98% (1217463-35-8) C ₆ H ₁₁ NOS; FW: 145.22; white to light-yellow powdr. Note: Sold in collaboration with Daicel for research purposes only.		500mg 2g
07-0616	(S)-4-Isopropyl-2-oxazolidinethione, min. 98% (104499-08-3) C ₆ H ₁₁ NOS; FW: 145.22; white to light-yellow powdr. Note: Sold in collaboration with Daicel for research purposes only.		500mg 2g
16-3025	1,3-(N-Mercaptoethylcarboxamide)benzene, 99% BDET (351994-94-0) See page 426		

NITROGEN (Compounds)

07-1100	Mesoporphyrin IX dihydrochloride (68938-72-7) $C_{34}H_{38}N_4O_4 \cdot 2HCl$; FW: 639.62; purple xtl.		10mg 50mg
07-1150	Mesoporphyrin IX, dimethyl ester, 97% (1263-63-4) $C_{36}H_{42}N_4O_4$; FW: 594.76; purple xtl.; m.p. 215°		10mg 50mg
07-1715	(8α, 9R)-6'-Methoxycinchonan-9-amine trihydrochloride, min. 90% $C_{20}H_{25}N_3O \cdot 3HCl$; FW: 432.81; white to off-white powdr. (store cold) For detailed technical note visit strem.com .		100mg 500mg
07-1710	(8α, 9S)-6'-Methoxycinchonan-9-amine trihydrochloride, min. 90% (1231763-32-8) $C_{20}H_{25}N_3O \cdot 3HCl$; FW: 432.81; pale yellow powdr. (store cold) For detailed technical note visit strem.com .		100mg 500mg
07-1158	2-(N-Methylamino)-1,1'-biphenyl, min. 95% (14925-09-8) $C_{13}H_{13}N$; FW: 183.25; pale-yellow liq. <i>air sensitive</i>		250mg 1g 5g
07-1215	5-Methyl-1H-benzotriazole, 99% (136-85-6) $C_7H_7N_3$; FW: 133.15; white to off-white solid		25g 100g 500g
07-1170	(2R)-(-)-N-Methyl-α,α-diphenyl-2-pyrrolidinemethanol, min. 98% (144119-12-0) $C_{18}H_{21}NO$; FW: 267.37; white to light-yellow powdr.; m.p. 68-71° Note: Sold in collaboration with Daicel for research purposes only. For detailed technical note visit strem.com .		100mg 250mg
07-1171	(2S)-(+)-N-Methyl-α,α-diphenyl-2-pyrrolidinemethanol, min. 98% (110529-22-1) $C_{18}H_{21}NO$; FW: 267.37; white to pale-yellow powdr.; m.p. 66-69° Note: Sold in collaboration with Daicel for research purposes only. For detailed technical note visit strem.com .		100mg 250mg
93-0711	Methylhydrazine, 98% (60-34-4) CH_3NNH_2 ; FW: 46.07; colorless to pale yellow liq.; b.p. 87°; f.p. 70°F; d. 0.866 Note: For sale in USA. For other countries contact Strem.		25g 100g

NITROGEN (Compounds)

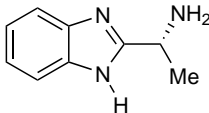
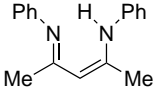
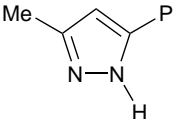
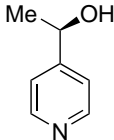
07-1234	(R)-(+)-2-(α -methylmethanamine)-1H-benzimidazole, min. 98% (R)-Me-BIMAH (163959-79-3) C ₉ H ₁₁ N ₃ ; FW: 161.2; white to off-white solid; m.p. 188-190° <i>air sensitive</i> Note: Sold under license from EnantioTech for research purposes only, PCT/CN2008/073648, CN 200810038929. EnantioTech BIMAH Ligand Kit component. For detailed technical note visit strem.com .		250mg 1g
07-1232	(S)-(-)-2-(α -methylmethanamine)-1H-benzimidazole, min. 98% (S)-Me-BIMAH (925689-54-9) C ₉ H ₁₁ N ₃ ; FW: 161.2; off-white to brown powder; m.p. 170-172° <i>air sensitive</i> Note: Sold under license from EnantioTech for research purposes only. PCT/CN2008/073648, CN 200810038929. EnantioTech BIMAH Ligand Kit component.		250mg 1g
Technical Note: 1. See 07-1234 (page 203)			
07-1264	1-Methyl-3-octylimidazolium tetrafluoroborate, 98% [OMIM] [BF ₄] (244193-52-0) See page 83		
07-1655	N-[1-Methyl-3-(phenylamino)-2-buten-1-ylidene]benzenamine, min. 98% NacNac (19164-92-2) C ₁₇ H ₁₈ N ₂ ; FW: 250.34; white solid		1g 5g 25g
07-1210	3-Methyl-5-phenyl-1H-pyrazole, 99% (3347-62-4) C ₁₀ H ₁₀ N ₂ ; FW: 158.20; pale yellow solid; m.p. 127-129°		500mg 2g
07-1725	1-Methyl-3-propylimidazolium phosphate, 99% (817575-04-5) See page 83		
07-1160	(R)-(+)- α -Methyl-4-pyridinemethanol, min. 98% (27854-88-2) C ₇ H ₉ NO; FW: 123.15; white to light-yellow powder. Note: Sold in collaboration with Daicel for research purposes only. For detailed technical note visit strem.com .		50mg 100mg
07-1161	(S)-(-)- α -Methyl-4-pyridinemethanol, min. 98% (54656-96-1) C ₇ H ₉ NO; FW: 123.15; white to light-yellow powder. Note: Sold in collaboration with Daicel for research purposes only.		50mg 100mg
Technical Note: 1. See 07-1160 (page 203)			
96-3775	NHC Ligand Kit 4: Bis Carbenes See page 514		
96-3760	NHC Ligand Kit 1: Chiral N-Heterocyclic Carbenes See page 512		
96-3770	NHC Ligand Kit 3: Variety of N-Heterocyclic Carbenes See page 513		
96-3765	NHC Ligand Kit 2: "Free" Carbenes See page 512		
96-0397	Nitric Oxide Sensor (Extracellular) Kit ("NO-ON") (FL2A) (Cell-impermeable NO fluorescent probe) See page 540		
96-0293	Nitric Oxide Sensor (Intracellular) Kit ("NO-ON") (FL) (Cell-trappable NO fluorescent probe) See page 542		
96-0396	Nitric Oxide Sensor (Intracellular) Kit ("NO-ON") (FL2E) (Cell-trappable NO fluorescent probe) See page 543		

NITROGEN (Compounds)

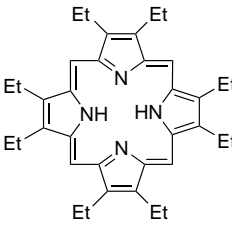
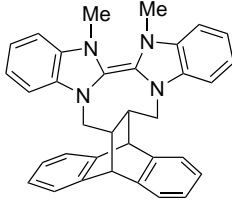
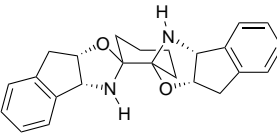
07-1475	Nitriiotriacetic acid, disodium salt, 99% (15467-20-6) HOOCCH ₂ N(CH ₂ COONa) ₂ ; FW: 235.10; white xtl.; m.p. > 300°	50g 250g
93-0738 HAZ	Nitronium hexafluoroantimonate, min. 97% (17856-92-7) NO ₂ SbF ₆ ; FW: 281.75; white xtl. <i>moisture sensitive</i> Note: Packaged in PFA/FET bottle.	10g
93-0739 HAZ	Nitronium hexafluorophosphate, min. 97% (19200-21-6) NO ₂ PF ₆ ; FW: 190.97; white xtl. <i>moisture sensitive</i>	10g
93-0740 HAZ	Nitronium tetrafluoroborate, min. 97% (13826-86-3) NO ₂ BF ₄ ; FW: 132.83; white xtl. <i>moisture sensitive</i> Note: Packaged in PFA/FET bottle.	5g 25g
93-0722 HAZ	Nitrosonium hexafluoroantimonate, min. 97% (16941-06-3) NOSbF ₆ ; FW: 265.75; white xtl. <i>moisture sensitive</i> Note: Packaged in PFA/FET bottle.	25g
93-0736 HAZ	Nitrosonium hexafluorophosphate, min. 97% (16921-91-8) NOPF ₆ ; FW: 174.96; white xtl. <i>moisture sensitive</i>	10g
93-0724 HAZ	Nitrosonium tetrafluoroborate, min. 97% (14635-75-7) NOBF ₄ ; FW: 116.78; white xtl.; b.p. subl. 250°/0.01 mm; d. 2.185 <i>moisture sensitive</i> Note: Packaged in PFA/FET bottle.	5g 25g
07-1550	Octaethylporphine, 97+% OEP (2683-82-1) C ₃₆ H ₄₆ N ₄ ; FW: 534.78; purple xtl.	250mg 1g
		
07-0086	(12a,18a)-5,6,12,12a,13,18,18a,19-Octahydro-5,6-dimethyl-13,18[1',2']-benzenobisbenzimidazo [1,2-b:2',1'-d]benzo[i][2.5]benzodiazocine potassium triflate adduct (958004-04-1) C ₃₄ H ₃₀ N ₄ ; CF ₃ SO ₃ K; FW: 494.63 (682.80); white powdr. <i>air sensitive</i> Note: Sold under license from UFRFI for research purposes only. Patent application PCT/US2008/054137. NHC Ligand Kit 4: Bis Carbenes Kit component.	100mg 500mg
		
07-0488	(1'R,2'R,3aS,3''aS,8aR,8''aR)(+)-3,3',3a,3''a,8,8'',8a,8''a-Octahydrodispiro[2H-indeno[1,2-d]oxazole-2,1'-cyclohexane-2'',2''-[2H]indeno[1,2-d]oxazole} WOLF BISOXAZOLIDINE (947515-50-6) C ₂₄ H ₂₆ N ₂ O ₂ ; FW: 374.48; white powdr. Note: Sold under license from Georgetown University for research purposes only. Patent pending. For detailed technical note visit strem.com .	250mg 1g
		
07-1665	Oleylamine, min. 70% (112-90-3) See page 168	
07-1668	Oleylamine, min. 95% (112-90-3) See page 168	

NITROGEN (Compounds)

07-1322	Peralloyoxycucurbit[6]uril (AOCB[6]) potassium sulfate, 94+% (558445-90-2) $C_{72}H_{84}N_{24}O_{24} \cdot XK_2SO_4$; FW: 1668.61; white solid <i>light sensitive</i> Note: Sold for R&D purposes only. US 7388099. Cucurbitural Kit component.		25mg
07-1650 HAZ	1,10-Phenanthroline, anhydrous, 99% (66-71-7) $C_{12}H_8N_2$; FW: 180.21; white xtl.; m.p. 114-117°; b.p. >300° <i>hygroscopic</i>		5g 25g 100g
07-1219	(4<i>S</i>,4'<i>S</i>)-2,2'-(1-Phenylpropane-2,2-diyl)bis(4-phenyl-4,5-dihydrooxazole) (S)-BnPh-SaBOX (1404433-37-9) $C_{27}H_{26}N_2O_2$; FW: 410.51; white solid For detailed technical note visit strem.com .		250mg 1g
07-1780	2-Phenylpyridine, 95% (1008-89-5) $C_{11}H_8N$; FW: 155.20; amber liquid; b.p. 268-270°; f.p. 230°; d. 1.086 <i>air sensitive</i> Note: Ligand for photocatalyst synthesis.		1g
07-1700	Phthalocyanine (574-93-6) $C_{32}H_{18}N_8$; FW: 514.55; blue black powdr.		1g 5g 25g
07-6110 amp HAZ	4-[Polyisobutyl(20)]-2,6-dimethylaniline (50% in heptane/polyisobutylene) $C_{88}H_{171}N$; FW: 1243; pale yellow liq.		1g 5g
07-6120 amp HAZ	4-[Polyisobutyl(18)]-2,6-(di-i-propyl)aniline (50% in heptane/polyisobutylene) $C_{84}H_{163}N$; FW: 1187; yellow-orange liq.		1g 5g

NITROGEN (Compounds)

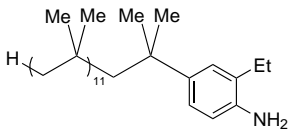
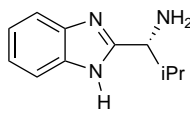
07-6115 amp HAZ	4-[Polyisobutyl(12)-2-ethylaniline (50% in heptane/polyisobutylene) C ₅₆ H ₁₀₇ N; FW: 794; red-orange liq.		1g 5g
07-1755	Poly-4-vinylpyridine, beads (50-60% H₂O) (9017-40-7) [-CH ₂ CH(C ₅ H ₄ N)CH ₂] _n ; off-white beads (18-50 mesh); b.p. 225° dec. (air), 260° dec. (N ₂); d. 1.15		50g 250g 1kg
07-1765	Poly-4-vinylpyridine, beads, anhydrous (toluene conditioned) (9017-40-7) [-CH ₂ CH(C ₅ H ₄ N)CH ₂] _n ; off-white beads; b.p. 225° dec. (air), 260° dec. (N ₂); d. 1.15		25g 100g 500g
07-1760	Poly-4-vinylpyridine, powder (~10% H₂O) (9017-40-7) [-CH ₂ CH(C ₅ H ₄ N)CH ₂] _n ; off-white granular powdr. (~60 mesh); b.p. 225° dec. (air), 260° dec. (N ₂); d. 1.15		50g 250g 1kg
07-1770	Poly-4-vinylpyridine, powder, anhydrous (toluene conditioned) (9017-40-7) [-CH ₂ CH(C ₅ H ₄ N)CH ₂] _n ; off-white granular powdr.; b.p. 225° dec. (air), 260° dec. (N ₂); d. 1.15		25g 100g 500g
07-1815	Polyvinylpyrrolidone (average mol. Wt. 10,000) PVP10 (9003-39-8) See page 168		
07-1817	Polyvinylpyrrolidone (average mol.wt. 40,000) PVP40 (9003-39-8) See page 168		
06-1850	i-Propylisocyanide, min. 97% (598-45-8) See page 40		
07-1238	(R)-(+)-2-(α-(i-propyl)methanamine)-1H-benzimidazole, min. 98% (R)-i-Pr-BIMAH (1235024-08-4) C ₁₁ H ₁₅ N ₃ ; FW: 189.26; white to off-white solid; m.p. 193-196° <i>air sensitive</i> Note: Sold under license from EnantioTech for research purposes only. PCT/CN2008/073648, CN 200810038929. EnantioTech BIMAH Ligand Kit component. For detailed technical note visit strem.com .		250mg 1g
07-1236	(S)-(-)-2-(α-(i-propyl)methanamine)-1H-benzimidazole, min. 98% (S)-i-Pr-BIMAH (59653-66-6) C ₁₁ H ₁₅ N ₃ ; FW: 189.26; white to off-white solid; m.p. 166-168° <i>air sensitive</i> Note: Sold under license from EnantioTech for research purposes only. PCT/CN2008/073648, CN 200810038929. EnantioTech BIMAH Ligand Kit component. For detailed technical note visit strem.com .		250mg 1g
07-1775	N-Propyl-3-methylpyridinium bis(trifluoromethylsulfonyl)imide, 99% [PMPIm] (817575-06-7) See page 83		
07-0099	(4R,5S)-(-)-4-i-Propyl-5-(3,3,4,4,5,5,6,6,7,7,8,8,8-tridecafluorooctyl)-2-oxazolidinone, 99% (1432793-97-9) C ₁₄ H ₁₄ F ₁₃ NO ₂ ; FW: 475.25; white powdr.; m.p. 96-99° Note: Sold under license for research purposes only. Patent PCT US/60/661,914. For detailed technical note visit strem.com .		100mg 500mg
07-0098	(4S,5R)-(-)-4-i-Propyl-5-(3,3,4,4,5,5,6,6,7,7,8,8,8-tridecafluorooctyl)-2-oxazolidinone, 99% (871210-22-9) C ₁₄ H ₁₄ F ₁₃ NO ₂ ; FW: 475.25; white powdr.; m.p. 96-99° Note: Sold under license for research purposes only. PCT US/60/661,914.		100mg 500mg

Technical Note:

- See 07-0099 (page 206)

NITROGEN (Compounds)

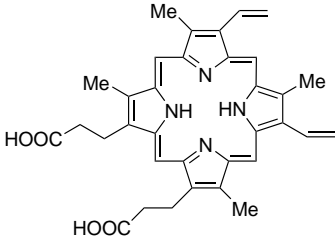
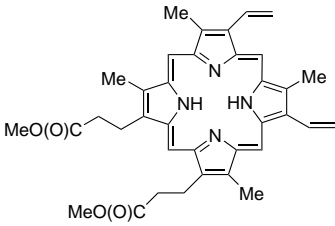
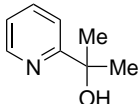
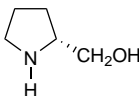
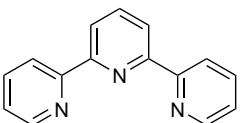
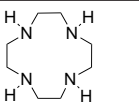
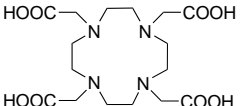
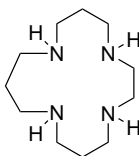
07-1820	Protoporphyrin IX (553-12-8) C ₃₄ H ₃₄ N ₄ O ₄ ; FW: 562.67; purple powdr. <i>light sensitive</i>		250mg 1g
07-1850	Protoporphyrin IX, dimethyl ester (5522-66-7 =) C ₃₆ H ₃₈ N ₄ O ₄ ; FW: 590.73; purple xtl.		100mg 500mg
07-3333	2-(Pyridine-2-yl)propan-2-ol, min. 95% pyalc (37988-38-8) C ₈ H ₉ N(O)C(CH ₃) ₂ (OH); FW: 137.18; white xtl.		100mg 500mg 2g
07-1885	Pyridinium trifluoromethanesulfonate, min. 97% (52193-54-1) [C ₅ H ₅ NH] ⁺ CF ₃ SO ₃ ⁻ ; FW: 229.18; white powdr.; m.p. 221-223° For detailed technical note visit strem.com .		5g 25g
07-1895	(R)-(-)-2-Pyrrolidinemethanol, 99% (D-Prolinol) (68832-13-3) C ₅ H ₁₁ NO; FW: 101.15; light-yellow, viscous liq.; b.p. 74-76° (2mm); d. 1.025 <i>air sensitive</i>		1g 5g 25g
07-1920	2,2':6',2''-Terpyridine, min. 98% TERPY (1148-79-4) C ₉ H ₄ NC ₅ H ₃ NC ₅ H ₄ N; FW: 233.27; off-white powdr.; m.p. 88-89°		1g 5g
07-1941	1,4,7,10-Tetraazacyclododecane, min. 98% CYCLEN (294-90-6) C ₈ H ₂₀ N ₄ ; FW: 172.28; white to off-white powdr. <i>hygroscopic</i>		1g 5g 25g
07-1942	1,4,7,10-Tetraazacyclododecane-N,N',N'',N'''-tetraacetic acid, min. 98% DOTA (60239-18-1) C ₁₆ H ₂₈ N ₄ O ₈ ; FW: 404.42; white powdr. Note: Ligand for MOF synthesis.		250mg 1g 5g
07-1955	1,4,8,12-Tetraazacyclopentadecane, min. 98% (15439-16-4) C ₁₁ H ₂₆ N ₄ ; FW: 214.35; white powdr.; m.p. 98-99° <i>hygroscopic</i>		250mg 1g

NITROGEN (Compounds)

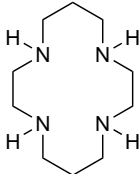
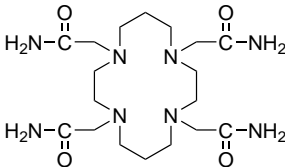
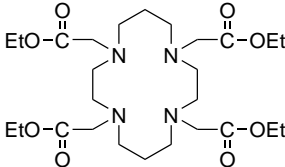
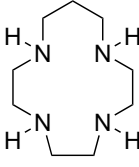
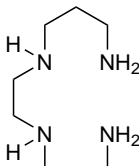
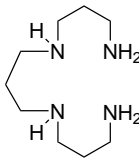
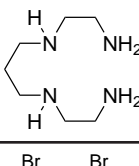
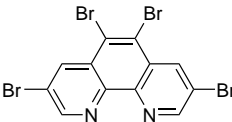
07-1959	1,4,8,11-Tetraazacyclotetradecane, min. 98% CYCLAM (295-37-4) $C_{10}H_{24}N_4$; FW: 200.33; off-white powdr.; m.p. 185-186°		250mg 1g 5g 25g
07-1932	1,4,8,11-Tetraazacyclotetradecane-N,N',N'',N'''-tetraacetamide, min. 98% (345612-63-7) $C_{18}H_{36}N_8O_4$; FW: 428.53; white to yellow powdr.		250mg 1g
07-1930	1,4,8,11-Tetraazacyclotetradecane-N,N',N'',N'''-tetraacetic acid, tetraethyl ester, min. 98% (126320-57-8) $C_{26}H_{48}N_8O_8$; FW: 544.68; white to yellow powdr.		250mg 1g
07-1934	1,4,7,10-Tetraazacyclotridecane, min. 98% (295-14-7) $C_9H_{22}N_4$; FW: 186.30; white to yellow powdr.		250mg 1g
07-1961 HAZ	1,5,8,12-Tetraazadodecane, min. 95% (10563-26-5) $C_8H_{22}N_4$; FW: 174.29; colorless to pale yellow liq.; b.p. 118°/0.2 mm; f.p. >230°F; d. 0.952 <i>air sensitive</i>		25g 100g 500g
07-1963 HAZ	1,5,9,13-Tetraazatridecane, min. 97% (4605-14-5) $C_9H_{25}N_4$; FW: 188.32; colorless to pale yellow liq.; b.p. 98-103°/1 mm; f.p. 230°F; d. 0.92 <i>air sensitive</i>		1g 5g 25g
07-1965 HAZ	1,4,8,11-Tetraazaundecane, min. 97% (4741-99-5) $C_7H_{20}N_4$; FW: 160.26; colorless to pale yellow liq.; b.p. 142-145°/8 mm; f.p. 230°F; d. 0.96 <i>air sensitive</i>		1g 5g 25g
07-1971	3,5,6,8-Tetrabromo-1,10-phenanthroline, 98% (66127-00-2) $C_{12}H_4Br_4N_2$; FW: 495.79; white powdr. For detailed technical note visit strem.com .		250mg 1g

NITROGEN (Compounds)

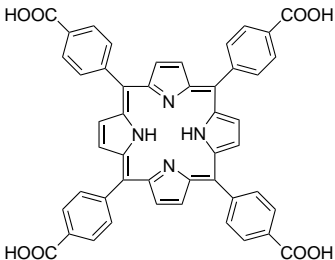
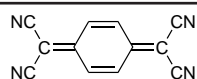
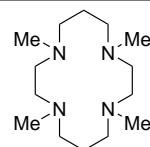
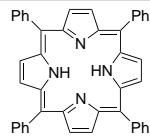
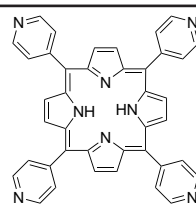
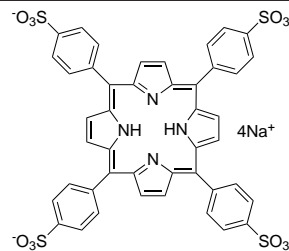
07-1970	meso-Tetra(4-carboxyphenyl)porphine, 98% (14609-54-2) $C_{48}H_{30}N_4O_8$; FW: 790.79; purple powdr.		250mg 1g
07-1975 HAZ	Tetracyanoethylene, 98% (670-54-2) $(CN)_2C=C(CN)_2$; FW: 128.09; off-white xtl.; m.p. 197-199°		5g 25g
07-1977 amp	7,7,8,8-Tetracyanoquinodimethane, 98% TCNQ (1518-16-7) $C_{12}H_4N_4$; FW: 204.19; orange xtl.; m.p. 296° dec.		5g 25g
07-2000 HAZ	Tetraethylenepentamine, tech gr. (~50% linear, 41% branched, 5% Triethylenetetramine, 4% polyethylene polyamines) TETRAEN (112-57-2) $HN(CH_2CH_2NHCH_2CH_2NH_2)_2$; FW: 189.31; colorless to yellow liq.; m.p. -40°; b.p. 340°; f.p. 365°F; d. 0.998 <i>air sensitive</i>		250g 1kg
07-2050 HAZ	N,N,N',N'-Tetramethylethylenediamine, 99% TMEDA (110-18-9) $(CH_3)_2NCH_2CH_2N(CH_3)_2$; FW: 116.21; colorless liq.; m.p. -55°; b.p. 120-122°; f.p. 68°F; d. 0.775		100g 500g
07-2112	1,4,8,11-Tetramethyl-1,4,8,11-tetraazacyclotetradecane, 98% (41203-22-9) $C_{14}H_{32}N_4$; FW: 256.43; white waxy xtl.; m.p. 34-36°; f.p. >230°F <i>moisture sensitive</i>		1g 5g
07-2160	meso-Tetraphenylporphine, min. 97% TPP (contains 1-3% chlorin) (917-23-7) $C_{44}H_{30}N_4$; FW: 614.75; purple xtl.		2g 10g
07-2170	meso-Tetraphenylporphine TPP (chlorin free) (917-23-7) $C_{44}H_{30}N_4$; FW: 614.75; violet xtl.		50mg 250mg
07-2300	meso-Tetra(4-pyridyl)porphine, 97% (16834-13-2) $C_{40}H_{26}N_8$; FW: 618.70; purple powdr.		1g 5g
07-2340	Tetrasodium-meso-tetra(4-sulfonatophenyl)porphine dodecahydrate, min. 95% (39050-26-5) $C_{44}H_{26}Na_4O_{12}S_4 \cdot 12H_2O$; FW: 1022.87 (1239.11); purple powdr.		250mg 1g

NITROGEN (Compounds)

07-2371	(1R,2R)-(-)-N-(4-toluenesulfonyl)-1,2-diphenylethylenediamine, 98% (R,R)-TsDPEN (144222-34-4) C ₂₁ H ₂₂ N ₂ O ₂ S; FW: 366.48; white xtl.; m.p. 127-129° Note: CATHy™ Catalyst Kit component.		500mg 2g 10g
07-2370	(1S,2S)-(+)-N-(4-toluenesulfonyl)-1,2-diphenylethylenediamine, 98% (S,S)-TsDPEN (167316-27-0) C ₂₁ H ₂₂ N ₂ O ₂ S; FW: 366.48; white xtl.; m.p. 127-129° Note: CATHy™ Catalyst Kit component.		500mg 2g 10g
07-2400 HAZ	2,2',2''-Triaminotriethylamine, min. 98% TREN (4097-89-6) N(CH ₂ CH ₂ NH ₂) ₃ ; FW: 146.24; colorless to pale yellow liq.; b.p. 98-99°/1 mm; f.p. >230°F; d. 0.977 <i>air sensitive</i>		10g 50g 250g
07-2500 HAZ	1,4,7-Triazacyclononane, 97% (4730-54-5) C ₆ H ₁₃ N ₃ ; FW: 129.20; white xtl.; f.p. 230°F		25mg 100mg
07-2625 NEW	2-[4-(Trifluoromethyl)phenyl]pyridine, 95% (203065-88-7) C ₁₂ H ₈ F ₃ N ₂ ; FW: 223.19; white to yellow solid <i>air sensitive</i> Note: Ligand for photocatalyst synthesis.		1g
07-1840 NEW	2-[(Trifluoromethyl)thio]-1,1-dioxide-1,2-benzisothiazol-3(2H)-one, 97% (1647073-46-8) C ₈ H ₄ F ₃ NO ₃ S ₂ ; FW: 283.25; white solid <i>air sensitive, moisture sensitive</i>		250mg 1g
07-2660	1,2,3-Trimethylimidazolium methyl sulfate, 98% [TriMIM] [MeSO ₄] (65086-12-6) See page 84		
07-0542	1-(2,4,6-Trimethylphenyl)-3-(adamantyl)imidazolium chloride, min. 97% (1583244-07-8) C ₂₂ H ₂₉ ClN ₂ ; FW: 356.94; white to off-white powdr. <i>hygroscopic</i>		250mg 1g
07-0545	1-(2,4,6-Trimethylphenyl)-3-(adamantyl)imidazolium tetrafluoroborate, min. 97% C ₂₂ H ₂₉ BF ₄ N ₂ ; FW: 356.94; white to off-white powdr. <i>hygroscopic</i>		250mg 1g
07-0530	1-(2,4,6-Trimethylphenyl)-3-(cyclododecyl)imidazolium chloride, min. 97% C ₂₄ H ₃₇ N ₂ Cl; FW: 389.02; white to off-white powdr. <i>hygroscopic</i>		250mg 1g
07-0534	1-(2,4,6-Trimethylphenyl)-3-(cyclododecyl)imidazolium tetrafluoroborate, min. 97% (1583244-17-0) C ₂₄ H ₃₇ BF ₄ N ₂ ; FW: 440.37; white to off-white powdr. <i>hygroscopic</i>		250mg 1g

NITROGEN (Compounds)

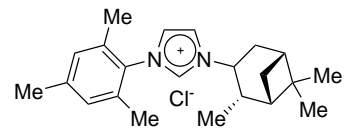
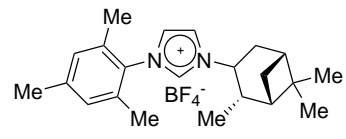
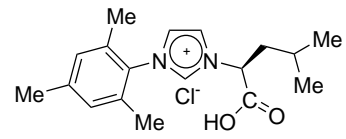
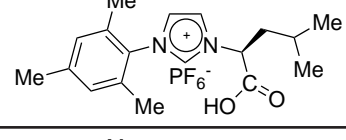
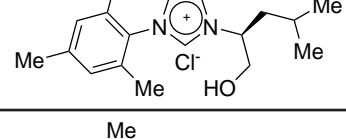
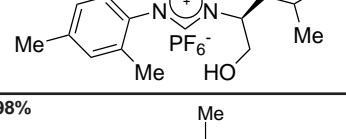
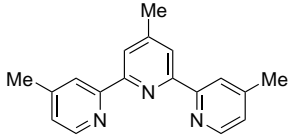
07-0522	1-(2,4,6-Trimethylphenyl)-3-[(1R,2R,3R,5S)-(-)-isopinocampheyl]imidazolium chloride, min. 95% (1583244-12-5) C ₂₂ H ₃₁ ClN ₂ ; FW: 358.95; white to off-white powdr. <i>hygroscopic</i>		100mg 500mg
07-0528	1-(2,4,6-Trimethylphenyl)-3-[(1R,2R,3R,5S)-(-)-isopinocampheyl]imidazolium tetrafluoroborate, min. 95% C ₂₂ H ₃₁ BF ₄ N ₂ ; FW: 410.30; white to off-white powdr. <i>hygroscopic</i>		100mg 500mg
07-0640	1-(2,4,6-Trimethylphenyl)-3-[(2S)-4-methylpentanoic acid]imidazolium chloride, min. 95% C ₁₈ H ₂₅ ClN ₂ O ₂ ; FW: 336.86; yellow solid <i>hygroscopic</i>		250mg 1g
07-0645	1-(2,4,6-Trimethylphenyl)-3-[(2S)-4-methylpentanoic acid]imidazolium hexafluorophosphate, min. 95% C ₁₈ H ₂₅ F ₆ N ₂ PO ₂ ; FW: 446.37; yellow solid <i>hygroscopic</i>		250mg 1g
07-0560	1-(2,4,6-Trimethylphenyl)-3-[(2S)-4-methyl-1-pentanol]imidazolium chloride, min. 97% C ₁₈ H ₂₇ ClN ₂ O; FW: 322.87; white to off-white powdr. <i>hygroscopic</i>		250mg 1g
07-0565	1-(2,4,6-Trimethylphenyl)-3-[(2S)-4-methyl-1-pentanol]imidazolium hexafluorophosphate, min. 97% C ₁₈ H ₂₇ F ₆ N ₂ OP; FW: 432.38; white to off-white powdr. <i>hygroscopic</i>		250mg 1g
07-2758	NEW 4,4',4''-Trimethyl-2,2':6',2''-terpyridine, 98% (33354-75-5) C ₁₈ H ₁₇ N ₃ ; FW: 275.35; white to off-white powdr.		500mg 2g
15-6400	2,8,9-Trimethyl-2,5,8,9-tetraaza-1-phosphabicyclo[3.3.3]undecane VERKADE SUPERBASE (120666-13-9) See page 329		
07-2750	amp 1,4,7-Trimethyl-1,4,7-triazacyclononane, min. 97% (96556-05-7) C ₉ H ₂₁ N ₃ ; FW: 171.28; pale yellow liq.; f.p. 155°F; d. 0.884 <i>moisture sensitive</i>		250mg 500mg 2g

NITROGEN (Compounds)

07-3100	5,10,15-Tri(pentafluorophenyl)corrole (262280-80-8) $C_{37}H_{11}F_{15}N_4$; FW: 796.52; purple pwdr. Note: US Patent 6,541,628 B1.	25mg	
Technical Note:			
1. Corroles are a class of tetradentate nitrogen ligands analogous to porphyrins. The corroles can act as trianionic ligands toward metal ions, and in particular, stabilize metal ions in high oxidation states such as Fe(IV), Co(IV) and Co(V).			
07-3215	Tris[(1-benzyl-1H-1,2,3-triazol-4-yl)methyl]amine, 97% TBTA (510758-28-8) $C_{30}H_{30}N_{10}$; FW: 530.63; white to off-white pwdr. (store cold)	250mg	
NEW	1g		
07-3110	Tris(isobutylaminoethyl)amine, min 97% (331465-73-7) $C_{18}H_{42}N_4$; FW: 314.55; colorless to pale yellow, viscous liq. <i>hygroscopic</i> Note: Ligand for MOF synthesis.	500mg	
2g			
07-3200	Tris(pyrazol-1-yl)methane, min. 98% (80510-03-8) $C_{10}H_{10}N_6$; FW: 214.23; white pwdr.; m.p. 103-104°	250mg	
1g			
07-3350	Uroporphyrin I, octamethyl ester (10170-03-3) $C_{48}H_{54}N_4O_{16}$; FW: 942.98; rust colored pwdr.; m.p. 291-292°	10mg	

NITROGEN (Compounds)

07-3410 Uroporphyrin III, octamethyl ester 5mg
(15435-60-6)
 $C_{48}H_{54}N_4O_{16}$; FW: 942.98; red to black pwdr.

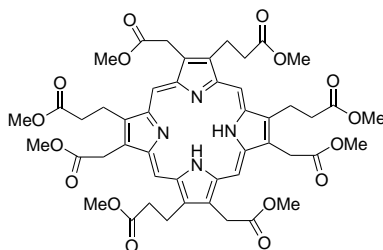
**OSMIUM (Elemental Forms)**

76-3000 Osmium powder (99.8%) (7440-04-2) 1g
HAZ Os; FW: 190.20; 100-200 mesh; m.p. 3000°; b.p. 5027°; d. 22.48 5g

OSMIUM (Compounds)

76-0080 Ammonium hexabromoosmate(IV), 99% (24598-62-7)
See page 5

76-0150 Bis(cyclopentadienyl)osmium, 99% (99.9%-Os) (Osmocene) (1273-81-0) 250mg
 $(C_5H_5)_2Os$; FW: 320.39; white xtl.; m.p. 226-228° 1g

76-0200 Bis(pentamethylcyclopentadienyl)osmium, 99% (99.9%-Os) (Decamethylosmocene) (100603-32-5) 500mg
amp $[(CH_3)_5C_5]_2Os$; FW: 460.66; off-white pwdr.

93-7610 Dihydrogen hexachloroosmate(IV) hexahydrate (27057-71-2) 1g
 $H_2OsCl_6 \cdot 6H_2O$; FW: 404.94 (513.01); black xtl. 5g
hygroscopic

76-2000 Osmium carbonyl, 99% (15696-40-9) 500mg
 $Os_3(CO)_{12}$; FW: 906.73; yellow xtl.; d. 3.48 2g

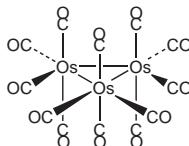

76-2200 Osmium(III) chloride hydrate (14996-60-2) 250mg
HAZ $OsCl_3 \cdot XH_2O$; FW: 296.56; black xtl.; m.p. >500° dec. 1g 5g

76-2210 Osmium(III) chloride hydrate (99.95+%-Os) (14996-60-2) 250mg
HAZ $OsCl_3$; FW: 296.56; black xtl. 1g 5g

76-2950 Osmium(VIII) oxide (99.95+%-Os) (20816-12-0) 250mg
amp OsO_4 ; FW: 254.20; pale yellow xtl.; m.p. 41-42°; d. 4.906 500mg
HAZ 1g 5 x 1g

76-2958 Osmium(VIII) oxide (99.99+%-Os) PURATREM (20816-12-0) 250mg
amp OsO_4 ; FW: 254.20; pale yellow xtl.; m.p. 41-42°; d. 4.906 500mg
HAZ 1g 5x1g

76-2955 Osmium(VIII) oxide (99.99+%-Os), 4% in water PURATREM (20816-12-0) 2ml
amp OsO_4 ; FW: 254.20; colorless liq. 5ml
HAZ 2x5ml

76-2952 Osmium(VIII) oxide, 4% in water (20816-12-0) 2ml
amp OsO_4 ; colorless liq. 5ml
HAZ 10ml

76-2956 Osmium(VIII) oxide, Microencapsulated in a Styrene Polymer (~10% OsO_4) 1g
HAZ OsO_4 ; black solid
For detailed technical note visit strem.com.

93-7611 Potassium hexachloroosmate(IV), 99% (16871-60-6)
See page 342

OSMIUM (Compounds)

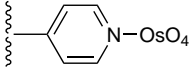
76-3510	Potassium hexachloroosmate (IV), 99% (99.98+%-Os) (16871-60-6) See page 342		
93-7613	Potassium osmate(VI) dihydrate, 99% (10022-66-9) See page 343		
76-4050	Potassium osmate(VI) dihydrate, 99% (99.98+%-Os) (10022-66-9) See page 343		
93-7612	Sodium hexachloroosmate(IV) hydrate (1307-81-9) See page 418		
76-3520	Sodium hexachloroosmate((IV) hydrate (99.98+%-Os) (1307-81-9) See page 418		
76-2970	Tetraoxopyridineosmium(VIII) (~7.5% Os) polymer-bound FibreCat™ yellow, fibrous solid Note: Limited quantities available.		5g

Technical Note:

1. A stable polymer-bound osmium tetroxide useful for the hydroxylation of olefins. Use of this catalyst effectively eliminates the hazard of working with osmium tetroxide in the free state, while still maintaining its activity as a catalyst.

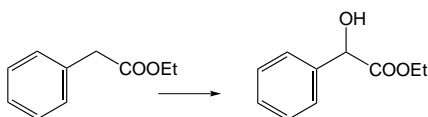
**OXYGEN (Compounds)**

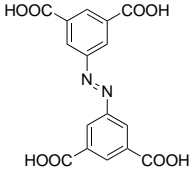
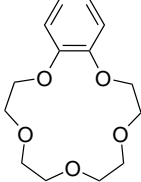
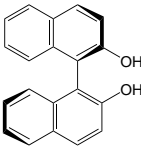
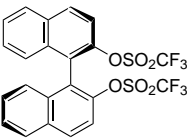
08-0125 NEW	3,3',5,5'-Azobenzene tetracarboxylic acid, TazbH₄, 97% (365549-33-33) C ₁₆ H ₁₀ N ₂ O ₈ ; FW: 358.26; yellow-orange powdr. Note: Ligand for MOF Synthesis		1g 5g
08-0150	Benzo-15-crown-5, 97% (14098-44-3) C ₁₄ H ₂₀ O ₅ ; FW: 268.31; white xtl.; m.p. 76-78° <i>air sensitive</i>		1g 5g
08-0999	racemic-1,1'-Bi-2-naphthol, 99% rac-BINOL (602-09-5) C ₂₀ H ₁₄ O ₂ ; FW: 286.32; white powdr.; m.p. 214-217°		5g 25g
08-1000	R-(+)-1,1'-Bi-2-naphthol, 99% (R)-BINOL (18531-94-7) HOC ₁₀ H ₆ -C ₁₀ H ₆ OH; FW: 286.33; white to off-white powdr.; m.p. 208-211°		1g 5g 25g
08-1001	S-(-)-1,1'-Bi-2-naphthol, 99% (S)-BINOL (18531-99-2) HOC ₁₀ H ₆ -C ₁₀ H ₆ OH; FW: 286.33; white to off-white powdr.; m.p. 207-210°		1g 5g 25g
08-0160	(R)-(-)-1,1'-Bi-2-naphthol bis(trifluoromethanesulfonate), 98% (126613-06-7) CF ₃ SO ₂ C ₁₀ H ₆ -C ₁₀ H ₆ O ₃ SCF ₃ ; FW: 550.45; white powdr.; m.p. 82-85° <i>moisture sensitive</i>		250mg 1g 5g

OXYGEN (Compounds)

08-0161	(S)-(+)-1,1'-Bi-2-naphthol bis(trifluoromethanesulfonate), 98% (128544-05-8) CF ₃ SO ₃ C ₁₀ H ₆ -C ₁₀ H ₆ O ₃ SCF ₃ ; FW: 550.45; white powdr.; m.p. 82-85° <i>moisture sensitive</i>	250mg 1g 5g
08-0175	[1,1'-Biphenyl]-4,4'-dicarboxylic acid, min. 98% (787-70-2) C ₁₄ H ₁₀ O ₄ ; FW: 242.23; white to pale-yellow solid Note: Ligand for MOF synthesis.	5g 25g
08-0163	(1R)-6,6'-Bis[3,5-bis(trifluoromethyl)phenyl]-2,2',3,3'-tetrahydro-1,1'-spirobi[1H-indene]-7,7'-diol, min. 98% (1286189-16-9) C ₃₃ H ₂₀ F ₁₂ O ₂ ; FW: 676.49; white to light-yellow powdr. Note: Sold in collaboration with Daicel for research purposes only.	25mg 100mg
08-0164	(1S)-6,6'-Bis[3,5-bis(trifluoromethyl)phenyl]-2,2',3,3'-tetrahydro-1,1'-spirobi[1H-indene]-7,7'-diol, min. 98% (1258327-01-3) C ₃₃ H ₂₀ F ₁₂ O ₂ ; FW: 676.49; white to light-yellow powdr. Note: Sold in collaboration with Daicel for research purposes only.	25mg 100mg
08-0170	(R)-(+)-2,2'-Bis(methoxymethoxy)-1,1'-binaphthyl, 98% (173831-50-0) C ₂₄ H ₂₂ O ₄ ; FW: 374.43; white powdr.; m.p. 100-103°	250mg 1g 5g
Technical Note: 1. Starting material for the preparation of a variety of 3,3'-substituted binaphthols.		
08-0171	(S)-(-)-2,2'-Bis(methoxymethoxy)-1,1'-binaphthyl, 98% (142128-92-5) C ₂₄ H ₂₂ O ₄ ; FW: 374.43; white powdr.; m.p. 100-103°	250mg 1g 5g
Technical Note: 1. See 08-0170 (page 215)		
08-0180	2,2'-Bis(trifluoromethanesulfonyloxy)-1,1'-biphenyl, 99% (1,1'-Biphenol bistriflate) (17763-95-0) C ₁₄ H ₈ F ₆ O ₆ S ₂ ; FW: 450.33; white powdr.	250mg 1g
08-0201	(2S,3S)-(+)-2,3-Butanediol, min. 97% (19132-06-0) CH ₃ CH(OH)CH(OH)CH ₃ ; FW: 90.12; colorless liq.; b.p. 179-182°; f.p. 185°F; d. 0.987 <i>hygroscopic</i>	100mg 500mg
08-0198	(S)-(+)-1,3-Butanediol, 98+% (24621-61-2) CH ₃ CH(OH)CH ₂ CH ₂ OH; FW: 90.12; colorless liq.; f.p. 249°F; d. 1.005 <i>hygroscopic</i>	250mg 1g
08-0300	15-Crown-5, 98% (33100-27-5) C ₁₀ H ₂₀ O ₅ ; FW: 220.26; pale yellow liq.; b.p. 78°/0.05 mm; f.p. >230°F; d. 1.109 <i>air sensitive</i>	2g 10g

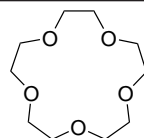
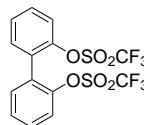
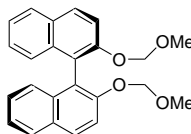
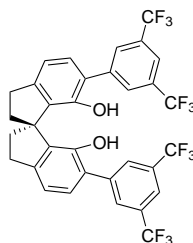
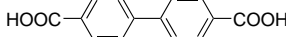

OXYGEN (Compounds)

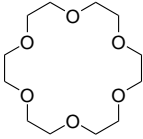
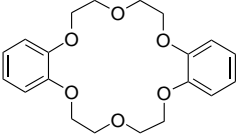
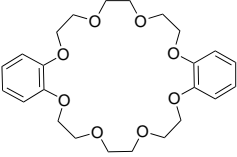
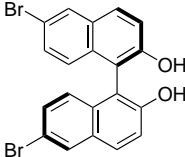
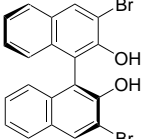
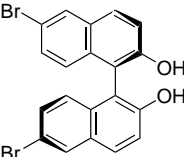
08-0320	18-Crown-6, 99% (17455-13-9) C ₁₂ H ₂₄ O ₆ ; FW: 264.32; white xtl.; m.p. 36-38°; f.p. >235°F <i>air sensitive</i>		10g 50g
08-0500	Dibenzo-18-crown-6, min. 98% (14187-32-7) C ₂₀ H ₁₂ O ₆ ; FW: 360.41; white powdr.; m.p. 162-164° <i>air sensitive</i>		10g 50g
08-0510	Dibenzo-24-crown-8, 98% (14174-09-5) C ₂₄ H ₃₂ O ₈ ; FW: 448.51; white xtl.; m.p. 103-104° <i>air sensitive</i>		1g 5g
08-0604	racemic-6,6'-Dibromo-1,1'-bi-2-naphthol, min. 98% (13185-00-7) C ₂₀ H ₁₂ Br ₂ O ₂ ; FW: 444.13; white powdr.; m.p. 202-205° For detailed technical note visit strem.com .		1g 5g
08-0185	(R)-(-)-6,6'-Dibromo-1,1'-bi-2-naphthol, 98% (99% ee) (65283-60-5) C ₂₀ H ₁₂ Br ₂ O ₂ ; FW: 444.12; white to light-yellow powdr. Note: Sold in collaboration with Daicel for research purposes only.		500mg 2g
08-0186	(S)-(+)-6,6'-Dibromo-1,1'-bi-2-naphthol, 98% (99% ee) (80655-81-8) C ₂₀ H ₁₂ Br ₂ O ₂ ; FW: 444.12; white to light-yellow solid Note: Sold in collaboration with Daicel for research purposes only.		500mg 2g
08-0600	(R)-(+)-3,3'-Dibromo-1,1'-bi-2-naphthol, min. 98% (111795-43-8) C ₂₀ H ₁₂ Br ₂ O ₂ ; FW: 444.13; white powdr.; m.p. 254-258° For detailed technical note visit strem.com .		100mg 500mg
08-0605	(R)-(-)-6,6'-Dibromo-1,1'-bi-2-naphthol, min. 98% (65283-60-5) C ₂₀ H ₁₂ Br ₂ O ₂ ; FW: 444.13; white powdr.; m.p. 92-96° For detailed technical note visit strem.com .		500mg 2g
08-0601	(S)-(-)-3,3'-Dibromo-1,1'-bi-2-naphthol, min. 98% (119707-74-3) C ₂₀ H ₁₂ Br ₂ O ₂ ; FW: 444.13; white powdr.; m.p. 257-262° For detailed technical note visit strem.com .		100mg 500mg
08-0606	(S)-(+)-6,6'-Dibromo-1,1'-bi-2-naphthol, min. 98% (80655-81-8) C ₂₀ H ₁₂ Br ₂ O ₂ ; FW: 444.13; white powdr.; m.p. 92-96° For detailed technical note visit strem.com .		500mg 2g

OXYGEN (Compounds)

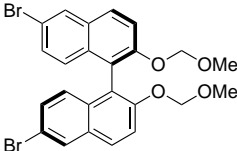
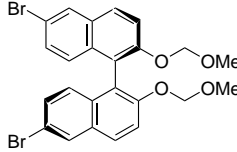
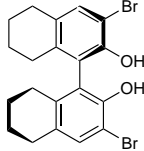
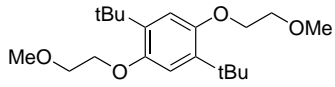
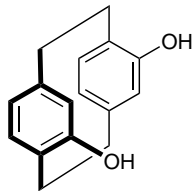
08-0152 NEW	(R)-(+)-6,6'-Dibromo-2,2'-bis(methoxymethoxy)-1,1'-binaphthalene, min. 98% (99% ee) (179866-74-1) C ₂₄ H ₂₀ Br ₂ O ₄ ; FW: 532.22; white to light-yellow powder; m.p. 133° Note: Sold in collaboration with Daicel for research purposes only.		100mg 500mg
08-0153 NEW	(S)-(-)-6,6'-Dibromo-2,2'-bis(methoxymethoxy)-1,1'-binaphthalene, min. 98% (99% ee) (211560-97-3) C ₂₄ H ₂₀ Br ₂ O ₄ ; FW: 532.22; white to light-yellow powder; m.p. 133° Note: Sold in collaboration with Daicel for research purposes only.		100mg 500mg
08-0620	(R)-(+)-6,6'-Dibromo-2,2'-bis(methoxymethoxy)-1,1'-binaphthyl, min. 98% (179866-74-1) C ₂₄ H ₂₀ Br ₂ O ₄ ; FW: 532.22; white powder; m.p. 133°		250mg 1g
Technical Note: 1. Starting material for the preparation of a variety of 6,6' and 3,3'-substituted BINOLS.			
08-0621	(S)-(-)-6,6'-Dibromo-2,2'-bis(methoxymethoxy)-1,1'-binaphthyl, min. 98% (211560-97-3) C ₂₄ H ₂₀ Br ₂ O ₄ ; FW: 532.22; white powder; m.p. 133°		250mg 1g
Technical Note: 1. See 08-0620 (page 217)			
08-0650	(R)-(+)-3,3'-Dibromo-5,5',6,6',7,7',8,8'-octahydro-1,1'-bi-2-naphthol, 99% (65355-08-0) C ₂₀ H ₂₀ Br ₂ O ₂ ; FW: 452.20; off-white powder.		250mg 1g
08-0651	(S)-(-)-3,3'-Dibromo-5,5',6,6',7,7',8,8'-octahydro-1,1'-bi-2-naphthol, 99% (765278-73-7) C ₂₀ H ₂₀ Br ₂ O ₂ ; FW: 452.20; off-white powder.		250mg 1g
08-0215 NEW	1,4-Di-t-butyl-2,5-bis(2-methoxyethoxy)benzene, 99+% Redox shuttle ANL-RS2 (1350770-63-6) C ₂₀ H ₃₄ O ₄ ; FW: 338.48; white to off-white powder; m.p. 69-70° <i>air sensitive, moisture sensitive</i> Note: U.S. Patent: 8,609,287. European Patent App.: 11787270.5. Chinese Patent App.: 11/80014192.6 For detailed technical note visit strem.com .		1g 5g
08-0700	racemic-4,12-Dihydroxy[2.2]paracyclophane, min. 97% (612492-27-0) C ₁₆ H ₁₆ O ₂ ; FW: 240.30; yellow to brown powder. Note: Paracyclophane Kit component.		100mg 500mg
08-1220 NEW	2,5-Dihydroxyterephthalic acid, 98% H ₄ DOBDC (610-92-4) C ₆ H ₂ (OH) ₂ (COOH) ₂ ; FW: 198.13; white powder. Note: Ligand for MOF Synthesis		1g 5g 25g

OXYGEN (Compounds)

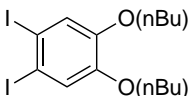
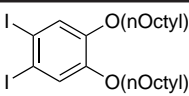
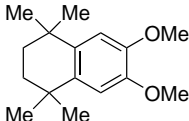
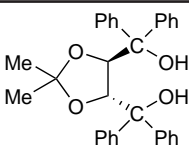
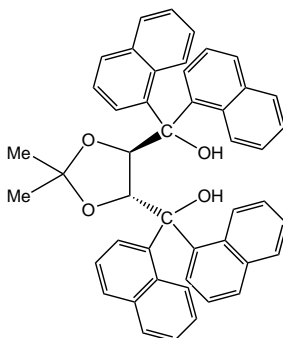
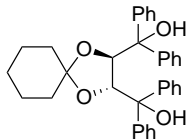
08-0720	1,2-Diiodo-4,5-di-n-butoxybenzene (1005340-01-1) C ₁₄ H ₂₀ I ₂ O ₂ ; FW: 474.12; white to yellow powdr.		250mg 1g
08-0722	1,2-Diiodo-4,5-di-n-octyloxybenzene (248277-14-7) C ₂₂ H ₃₆ I ₂ O ₂ ; FW: 586.33; white to yellow powdr.		250mg 1g
08-0220 NEW	6,7-Dimethoxy-1,1,4,4-tetramethyl-1,2,3,4-tetrahydronaphthalene, 99+% Redox shuttle ANL-RS21 (22825-00-9) C ₁₆ H ₂₄ O ₂ ; FW: 248.36; off-white solid <i>air sensitive, moisture sensitive</i> Note: U.S. Patent: 13/457,239. For detailed technical note visit strem.com .		1g 5g
08-2008	(4R,5R)-(-)-2,2-Dimethyl-α, α', α', α'-tetraphenyl-1,3-dioxolane-4,5-dimethanol (R,R)-TADDOL (93379-48-7) C ₃₁ H ₃₀ O ₄ ; FW: 466.57; white powdr.; m.p. 193-195°		500mg 2g
08-2000	2,2-Dimethyl-3,5-hexanedione, min. 97% (7307-04-2) (CH ₃) ₂ CC(O)CH ₂ C(O)CH ₃ ; FW: 142.20; colorless liq.		1g 5g 25g
08-2004	(4R,5R)-(-)-2,2-Dimethyl-α,α,α',α'-tetra(1-naphthyl)-1,3-dioxolane-4,5-dimethanol, min. 97% (R,R)-1-Nph-TADDOL (137536-94-8) C ₄₇ H ₃₈ O ₄ ; FW: 666.82; white powdr.; m.p. 200° (dec.)		500mg 2g
08-0611 NEW	(2R,3R)-1,4-Dioxaspiro[4.5]decane-2,3-diylbis(diphenylmethanol), min. 98% (114026-76-5) C ₃₄ H ₃₄ O ₄ ; FW: 506.63; white to light-yellow powdr. Note: Sold in collaboration with Daicel for research purposes only.		500mg 2g
08-0612 NEW	(2S,3S)-1,4-Dioxaspiro[4.5]decane-2,3-diylbis(diphenylmethanol), min. 98% (123287-35-4) C ₃₄ H ₃₄ O ₄ ; FW: 506.63; white to light-yellow powdr. Note: Sold in collaboration with Daicel for research purposes only.		500mg 2g

OXYGEN (Compounds)

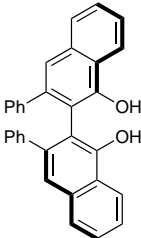
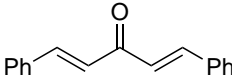
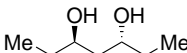
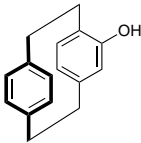
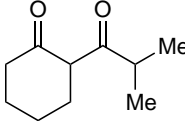
08-1700	(2R)-(+)-3,3'-Diphenyl-[2,2'-binaphthalene]-1,1'-diol, min. 98% (R)-VANOL (147702-13-4) $C_{32}H_{22}O_2$; FW: 438.52; white to pale yellow powder. For detailed technical note visit strem.com .		100mg 500mg
08-1702	(2S)-(-)-3,3'-Diphenyl-[2,2'-binaphthalene]-1,1'-diol, min. 98% (S)-VANOL (147702-14-5) $C_{32}H_{22}O_2$; FW: 438.52; white to pale yellow powder. For detailed technical note visit strem.com .		100mg 500mg
08-1704	(3R)-(-)-2,2'-Diphenyl-[3,3'-biphenanthrene]-4,4'-diol dichloromethane adduct, min. 98% (R)-VAPOL (147702-16-7) $C_{40}H_{26}O_2 \cdot \frac{1}{2}CH_2Cl_2$; FW: 538.63 (581.10); white to pale yellow powder. For detailed technical note visit strem.com .		100mg 500mg
08-1706	(3S)-(+)-2,2'-Diphenyl-[3,3'-biphenanthrene]-4,4'-diol dichloromethane adduct, min. 98% (S)-VAPOL (147702-15-6) $C_{40}H_{26}O_2 \cdot \frac{1}{2}CH_2Cl_2$; FW: 538.63 (581.10); white to pale yellow powder. For detailed technical note visit strem.com .		100mg 500mg
08-0625	1,5-Diphenyl-1,4-pentadien-3-one, min. 98% (Dibenzylideneacetone) (538-58-9) $C_{17}H_{14}O$; FW: 234.30; yellow solid		1g 5g
09-4496	6,6,7,7,8,8,8-Heptafluoro-2,2-dimethyl-3,5-octanedione, 98+% HFOD (17587-22-3) See page 64		
08-2014	(3R,5R)-(-)-3,5-Heptanediol, 99% (77291-90-8) $C_7H_{16}O_2$; FW: 132.20; colorless solid; m.p. 52°		250mg 1g
08-2015	(3S,5S)-(+)-3,5-Heptanediol, 99% (129212-21-1) $C_7H_{16}O_2$; FW: 132.20; colorless solid; m.p. 52°		250mg 1g
08-0750	Hexafluoroacetylacetone, min. 98% HFAA (1522-22-1) See page 64		
08-2024	(2R,5R)-(-)-2,5-Hexanediol, 99% (17299-07-9) $CH_3CH(OH)CH_2CH_2CH(OH)CH_3$; FW: 118.18; colorless xtl.; m.p. 50-53°		500mg 2g
08-2025	(2S,5S)-(+)-2,5-Hexanediol, 99% (34338-96-0) $CH_3CH(OH)CH_2CH_2CH(OH)CH_3$; FW: 118.18; colorless xtl.; m.p. 50-53°		500mg 2g
08-2027	racemic-4-Hydroxy[2.2]paracyclophane, min. 97% (157018-15-0) $C_{16}H_{16}O$; FW: 224.30; yellow to tan powder. Note: Paracyclophane Kit component.		250mg 1g
08-2029	2-Isobutyrylcyclohexanone, 96% (~96% enol form) (39207-65-3) $C_{10}H_{16}O_2$; FW: 168.23; colorless liq.; m.p. 38°		1g 5g
08-1235	2,6-Naphthalenedicarboxylic acid, min. 98% (1141-38-4) $C_{10}H_6(COOH)_2$; FW: 216.19; white powder; m.p. >300° Note: Ligand for MOF synthesis.		5g 25g

NEW

OXYGEN (Compounds)

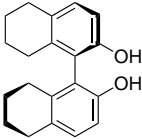
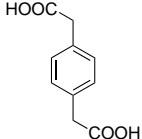
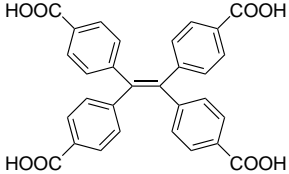
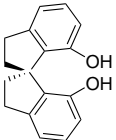
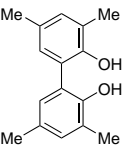
08-2035	(R)-(+)-5,5',6,6',7,7',8,8'-Octahydro-1,1'-bi-2-naphthol, 99% (65355-14-8) $C_{20}H_{22}O_2$; FW: 294.40; off-white powd.		250mg 1g
08-2036	(S)-(-)-5,5',6,6',7,7',8,8'-Octahydro-1,1'-bi-2-naphthol, 99% (65355-00-2) $C_{20}H_{22}O_2$; FW: 294.40; off-white powd.		250mg 1g
19-1600	(R)-(-)-5,5',6,6',7,7',8,8'-Octahydro-3,3'-di-t-butyl-1,1'-bi-2-naphthol, dipotassium salt (350683-75-9) See page 340		
19-1601	(S)-(+)-5,5',6,6',7,7',8,8'-Octahydro-3,3'-di-t-butyl-1,1'-bi-2-naphthol, dipotassium salt See page 340		
08-2037	(3R,6R)-(-)-3,6-Octanediol, 99% (129619-37-0) $C_2H_5C(OH)CH_2CH_2C(OH)C_2H_5$; FW: 146.23; colorless xtl.; m.p. 49-51°		250mg 1g
08-2038	(3S,6S)-(+)-3,6-Octanediol, 99% (136705-66-3) $C_2H_5C(OH)CH_2CH_2C(OH)C_2H_5$; FW: 146.23; colorless xtl.; m.p. 49-51°		250mg 1g
96-7052	Paracyclophane Kit See page 544		
08-2030	(2R,4R)-(-)-2,4-Pentanediol, 99% (42075-32-1) $C_5H_{12}O_2$; FW: 104.15; white xtl.; m.p. 48-50° hygroscopic		250mg 1g
08-2031	(2S,4S)-(+)-2,4-Pentanediol, 99% (72345-23-4) $C_5H_{12}O_2$; FW: 104.15; white xtl.; m.p. 48-50° hygroscopic		250mg 1g
08-1165	1,4-Phenylenediacetic acid, 97% (7325-46-4) $C_8H_8(CH_2COOH)_2$; FW: 194.18; white to off-white solid Note: Ligand for MOF synthesis.		1g 5g
08-1650	Polyethylene glycol sorbitan monolaurate (TWEEN® 20) (9005-64-5) See page 168		
08-2040	(S)-(+)-1,2-Propanediol, 99% (4254-15-3) $CH_3CH(OH)CH_2OH$; FW: 76.10; clear, viscous liq.; b.p. 77°/9mm; f.p. 225°F; d. 1.040		1g 5g
08-3060	1,1,2,2-Tetra(4-carboxylphenyl)ethylene, 99% H_4TCPE (1351279-73-6) $C_{30}H_{20}O_8$; FW: 508.48; pale yellow powd. Note: Ligand for MOF synthesis.		25mg 100mg
08-2065	(R)-2,2',3,3'-Tetrahydro-1,1'-spirobi[indene]-7,7'-diol, 99% (223259-62-9) $C_{17}H_{16}O_2$; FW: 252.31; white solid Note: Sold in collaboration with Daicel for research purposes only.		250mg 1g
08-2043	3,3',5,5'-Tetramethyl-2,2'-biphenol, 99% (26567-10-2) $C_{16}H_{18}O_2$; FW: 242.31; white powd.; m.p. 134-136°		100mg 500mg

OXYGEN (Compounds)

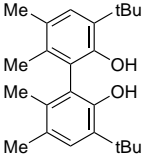
08-2045	racemic-5,5',6,6'-Tetramethyl-3,3'-di-<i>t</i>-butyl-1,1'-biphenyl-2,2'-diol, 99% rac-BIPHEN H₂ (101203-31-0) C ₂₄ H ₃₄ O ₂ ; FW: 354.54; white to off-white xtl.; m.p. 163-165° For detailed technical note visit strem.com .		5g 25g
08-2046	(R)-(+)-5,5',6,6'-Tetramethyl-3,3'-di-<i>t</i>-butyl-1,1'- biphenyl-2,2'-diol, 99% (R)-BIPHEN H₂ (329735-68-4) C ₂₄ H ₃₄ O ₂ ; FW: 354.54; white powdr. For detailed technical note visit strem.com .		100mg 500mg 2g
08-2047	(S)-(-)-5,5',6,6'-Tetramethyl-3,3'-di-<i>t</i>-butyl-1,1'- biphenyl-2,2'-diol, 99% (S)-BIPHEN H₂ (205927-03-3) C ₂₄ H ₃₄ O ₂ ; FW: 354.54; white powdr.		100mg 500mg 2g

Technical Note:

- See 08-2046 (page 221)

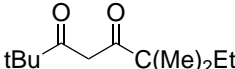
08-2050	2,2,6,6-Tetramethylheptane-3,5-dione, 98% TMHD (1118-71-4) (CH ₃) ₃ CC(O)CH ₂ C(O)C(CH ₃) ₃ ; FW: 184.28; colorless to pale yellow liq. or low melting solid; b.p. 72-73°/6 mm; f.p. 153°F; d. 0.883		5g 25g 100g
08-2100	2,2,6,6-Tetramethyl-3,5-octanedione, 98% (TMOD) (78579-61-0) (CH ₃) ₃ C(O)CH ₂ C(O)C(C ₂ H ₅)(CH ₃) ₂ ; FW: 198.31; colorless to pale yellow liq.		1g 5g

Technical Note:

- Ligand of choice for the preparation of low melting, volatile beta-diketonate complexes.

References:

- Jpn. J. Appl. Phys.*, **1997**, 36, 11, 6871
- Advanced Materials for Optics and Electronics*, **2000**, 10, 3, 5, 201

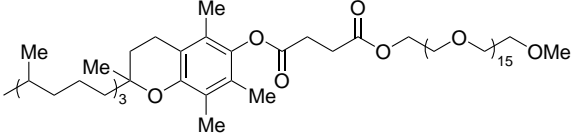
09-6950	2-Thenoyltrifluoroacetone, 99% (TTA) (326-91-0) See page 65		
08-2180	DL-α-Tocopherol methoxypolyethylene glycol succinate solution (2 wt% in water) TPGS-750-M C ₆₆ H ₁₁₇ O ₂₁ ; FW: 1246.62; colorless liq. Note: Surfactant for nanomaterial synthesis. For detailed technical note visit strem.com .		10ml 50ml

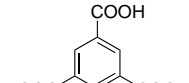
08-0195	1,3,5-Tricarboxybenzene, min. 95% (Trimesic acid) BTC (554-95-0) C ₆ H ₃ (COOH) ₃ ; FW: 210.14; white powdr. Note: Ligand for MOF synthesis.		50g 250g
---------	--	---	-------------

09-7210	1,1,1-Trifluoroacetylacetone, min. 98% (367-57-7) See page 65		
---------	---	--	--

08-2500	Trimethyloxonium tetrafluoroborate, min. 95% (420-37-1) HAZ (CH ₃) ₃ OBF ₄ ; FW: 147.93; white to off-white xtl. <i>heat sensitive, (store cold)</i>		5g 25g
---------	--	--	-----------

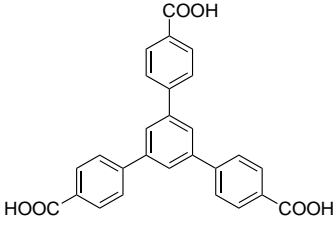
08-0635	1,3,5-Tris(4-carboxyphenyl)benzene, min. 98% BTB (50446-44-1) C ₂₇ H ₁₈ O ₆ ; FW: 438.43; white to yellow solid; m.p. 322-327° Note: Ligand for MOF synthesis.		1g 5g
---------	--	---	----------

PALLADIUM (Elemental Forms)

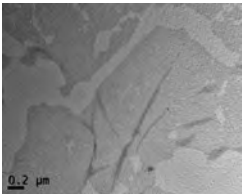
96-6715	BASF Blocking Group Removal Catalyst Kit See page 467	
96-6717	BASF Heterogeneous Catalyst Kit See page 467	
96-6719	BASF Palladium Catalyst Kit See page 468	
96-6670	Evonik Heterogeneous Catalyst Kit See page 484	
96-6672	Evonik Heterogeneous Palladium Catalyst Kit See page 484	
28-0015	Nickel/palladium alloy nanoparticle on graphene (G-Ni ₃₃ Pd ₆₇) black powdr. Note: U.S. Patent Application 14/667,859. For detailed technical note visit strem.com .	25mg 100mg
		
46-1706	Palladium, 10% on activated carbon, Pearlman (50-70% wetted powder) Evonik Noblyst® P1070 (7440-05-3) wetted, black powdr. Note: Sold in collaboration with Evonik for research purposes only. Evonik Heterogeneous Catalyst Kit component. Evonik Heterogeneous Palladium Catalyst Kit component.	10g 50g
46-1890 HAZ	Palladium, 10% on activated carbon, reduced, dry powder (7440-05-3) Pd on carbon; powdr.; SA: ~1050 m ² /g; P.Vol. 0.61 cc/g	5g 25g 100g
46-1900 HAZ	Palladium, 10% on activated carbon, reduced, dry powder (7440-05-3) Pd on carbon; powdr.; SA: ~1000 m ² /g; P.Vol. 0.61 cc/g	2g 10g 50g
46-1907	Palladium, 3% on activated carbon, reduced, 50% water wet paste (Escat™ 1911) (7440-05-3) black powdr. (d ₅₀ =38 μm); SA: 1500m ² /g Note: Sold in collaboration with BASF for research purposes only. BASF Blocking Group Removal Catalyst Kit component.	10g 50g
46-1908	Palladium, 5% on activated carbon, reduced, 50% water wet paste (Escat™ 1941) (7440-05-3) black powdr. (d ₅₀ =38 μm); SA: 1500m ² /g Note: Sold in collaboration with BASF for research purposes only. BASF Blocking Group Removal Catalyst Kit component.	10g 50g
46-1909	Palladium, 5% on activated carbon, reduced, 50% water wet paste (Escat™ 1961) (7440-05-3) black powdr. (d ₅₀ =20 μm); SA: 850m ² /g Note: Sold in collaboration with BASF for research purposes only. BASF Blocking Group Removal Catalyst Kit component.	10g 50g
46-1911	Palladium, 5% on activated carbon, reduced, 50% water wet paste (Escat™ 1971) (7440-05-3) black powdr. (d ₅₀ =27 μm); SA: 900m ² /g Note: Sold in collaboration with BASF for research purposes only. BASF Blocking Group Removal Catalyst Kit component.	10g 50g
46-1707	Palladium, 20% on activated carbon (Pearlman's catalyst), unreduced, 50% water wet paste (Escat™ 1951) (7440-05-3) black powdr. (d ₅₀ =24 μm); SA: 850m ² /g Note: Sold in collaboration with BASF for research purposes only. BASF Heterogeneous Catalyst Kit component. BASF Palladium Catalyst Kit component.	5g 25g

Technical Note:

1. Escat™ 1951 catalyst is recommended for a broad range of reactions common to palladium on carbon catalysts. Specifically, it is well suited for removal of protecting groups such as benzyl, Fmoc and others.

PALLADIUM (Elemental Forms)

46-1710	Palladium, 0.6% on activated carbon, 50% water-wet paste (NanoSelect LF 100) (7440-05-3) black solid (d50=25 µm) Note: Sold in collaboration with BASF for research purposes only. BASF Heterogeneous Catalyst Kit component. BASF Palladium Catalyst Kit component.	5g 25g
Technical Note: 1. NanoSelect LF 100 is a lead-free, water-wet, catalyst containing metal crystallites sizes of around 7 nm, and a mean particle size of 25 microns. The metal crystallites are supported on a carbon powder. The presence of nanometer-sized metal particles greatly increases the metal surface area available per gram of catalyst, and boosts catalytic activity. The catalyst is recommended for use in hydrogenation reactions leading to the partial reduction of functional groups. It is specifically suited for the selective hydrogenation of alkynes to alkenes, with a high selectivity for cis-alkenes.		
46-1703	Palladium, 5% on activated carbon (50-70% wetted powder) Evonik Noblyst® P1086 (7440-05-3) wetted, black pwdr. Note: Sold in collaboration with Evonik for research purposes only. Evonik Heterogeneous Catalyst Kit component. Evonik Heterogeneous Palladium Catalyst Kit component.	10g 50g
46-1740	Palladium, 5% on activated carbon (50-70% wetted powder) Evonik Noblyst® P1090 (7440-05-3) wetted, black pwdr. Note: Sold in collaboration with Evonik for research purposes only. Evonik Heterogeneous Catalyst Kit component. Evonik Heterogeneous Palladium Catalyst Kit component.	10g 50g
46-1747	Palladium, 5% on activated carbon (50-70% wetted powder) Evonik Noblyst® P1092 (7440-05-3) wetted, black pwdr. Note: Sold in collaboration with Evonik for research purposes only. Evonik Heterogeneous Catalyst Kit component. Evonik Heterogeneous Palladium Catalyst Kit component.	10g 50g
46-1743	Palladium, 5% on activated carbon (50-70% wetted powder) Evonik Noblyst® P1093 (7440-05-3) wetted, black pwdr. Note: Sold in collaboration with Evonik for research purposes only. Evonik Heterogeneous Catalyst Kit component. Evonik Heterogeneous Palladium Catalyst Kit component.	10g 50g
46-1750	Palladium, 5% on activated carbon (50-70% wetted powder) Evonik Noblyst® P1109 (7440-05-3) wetted, black pwdr. Note: Sold in collaboration with Evonik for research purposes only. Evonik Heterogeneous Catalyst Kit component. Evonik Heterogeneous Palladium Catalyst Kit component.	10g 50g
46-1901	Palladium, 5% on activated peat carbon, reduced, 50% water wet paste (Escat™ 1621) (7440-05-3) black pwdr. (d50=15 µm); SA: 850m ² /g Note: Sold in collaboration with BASF for research purposes only. BASF Heterogeneous Catalyst Kit component. BASF Palladium Catalyst Kit component.	10g 50g
Technical Note: 1. Escat™ 1621 catalyst is recommended for a broad range of reactions common to palladium on carbon catalysts, such as hydrogenolysis under hydrogen transfer conditions.		
46-1902 HAZ	Palladium, 5% on activated wood carbon, reduced, dry (Escat™ 1431) (7440-05-3) black pwdr. (d50=18 µm); SA: 900m ² /g Note: Sold in collaboration with BASF for research purposes only. BASF Heterogeneous Catalyst Kit component.	10g 50g
Technical Note: 1. Escat™ 1431 catalyst is recommended for a broad range of reactions common to palladium on carbon catalysts, where water is detrimental to the selectivity of the reaction. Active over a wide range of conditions.		

PALLADIUM (Elemental Forms)

46-1905	Palladium, 10% on activated wood carbon, reduced, 50% water wet (Escat™ 1931) (7440-05-3) black powdr. (d50=38 µm); SA: 1500m ² /g Note: Sold in collaboration with BASF for research purposes only. BASF Blocking Group Removal Catalyst Kit component. BASF Heterogeneous Catalyst Kit component. BASF Palladium Catalyst Kit component.	10g 50g
Technical Note: 1. Escat™ 1931 catalyst is recommended for a broad range of reactions commonly catalyzed by palladium on carbon. Specifically, it is well suited for removal of protecting groups such as benzyl, FMOc and others.		
46-1903	Palladium, 5% on activated wood carbon, reduced, 50% water wet paste (Escat™ 1421) (7440-05-3) black powdr. (d50=18 µm); SA: 900m ² /g Note: Sold in collaboration with BASF for research purposes only. BASF Heterogeneous Catalyst Kit component. BASF Palladium Catalyst Kit component.	10g 50g
Technical Note: 1. Escat™ 1421 catalyst is recommended for a broad range of reactions commonly catalyzed by palladium on carbon.		
46-1904	Palladium, 5% on activated wood carbon, unreduced, 50% water wet paste (Escat™ 1471) (7440-05-3) black powdr. (d50=18 µm); SA: 900m ² /g Note: Sold in collaboration with BASF for research purposes only. BASF Heterogeneous Catalyst Kit component. BASF Palladium Catalyst Kit component.	10g 50g
Technical Note: 1. Escat™ 1471 catalyst is recommended for a broad range of reactions common to palladium on carbon catalysts. Specifically, it is well suited for hydrogenolysis reactions using molecular hydrogen. Active over a wide range of conditions.		
46-1906	Palladium, 10% on activated wood carbon, unreduced, 50% water wet (Escat™ 1921) (7440-05-3) black powdr. (d50=38 µm); SA: 1500m ² /g Note: Sold in collaboration with BASF for research purposes only. BASF Blocking Group Removal Catalyst Kit component. BASF Palladium Catalyst Kit component.	10g 50g
Technical Note: 1. Escat™ 1921 catalyst is recommended for a broad range of reactions common to palladium on carbon catalysts. Specifically, it is well suited for removal of protecting groups such as benzyl, FMOc and others.		
46-1920	Palladium, 0.5% on alumina, reduced (7440-05-3) Pd on alumina; 1/8" x 1/8" pellets; SA: ~90 m ² /g	25g 100g
46-1950	Palladium, 5% on alumina, reduced, dry powder (7440-05-3) Pd on alumina; powdr.	5g 25g 100g
46-1951	Palladium, 5% on alumina powder, reduced, dry (Escat™ 1241) (7440-05-3) gray powdr. (d50=70 µm); SA: 110m ² /g Note: Sold in collaboration with BASF for research purposes only. BASF Heterogeneous Catalyst Kit component. BASF Palladium Catalyst Kit component.	5g 25g
Technical Note: 1. Escat™ 1241 catalyst is recommended for selective hydrogenation reactions such as alkyne reduction in the presence of carboxylic groups. The particle size of the catalyst is ideal for allowing fast separation from the reaction mixture.		
46-1970	Palladium, 5% on barium carbonate, reduced (7440-05-3) Pd on BaCO ₃ ; powdr.; SA: high	10g 50g
46-1989	Palladium, 5% on barium sulfate, reduced (7440-05-3) gray to black powdr.; SA: ~2.8m ² /g; P.Vol. 0.61 cc/g	10g 50g
46-1990	Palladium, 5% on barium sulfate, unreduced (7440-05-3) Pd on BaSO ₄ ; brown powdr.; SA: ~2.8m ² /g; P.Vol. 0.61 cc/g	10g 50g
46-1830 HAZ	Palladium black (99.9%) (7440-05-3) Pd; FW: 106.40; powdr.; SA: ~23 m ² /g; m.p. 1552°; b.p. 3140°; d. 12.02	1g 5g
46-2020	Palladium, 5% on calcium carbonate, lead-poisoned (LINDLAR CATALYST) (7440-05-3) Pd on CaCO ₃ ; powdr.; SA: 5-10 m ² /g; P.Vol. 0.38 cc/g	10g 50g
46-2010	Palladium, 5% on calcium carbonate, unpoisoned, reduced (7440-05-3) Pd on CaCO ₃ ; powdr.; SA: 5-10 m ² /g	10g 50g
46-2015	Palladium, 5% on calcium carbonate, unpoisoned, unreduced (7440-05-3) Pd on CaCO ₃ ; light brown powdr.; SA: 12m ² /g	10g 50g

PALLADIUM (Elemental Forms)

46-2022	Palladium, 5% on calcium carbonate, unreduced, dry (Escat™ 1371) (7440-05-3) brownish pwdr. (d50=3 µm); SA: 7m ² /g Note: Sold in collaboration with BASF for research purposes only.	5g 25g
Technical Note: 1. Escat™ 1371 catalyst is recommended for selective hydrogenation reactions in which other palladium catalysts can lead to over-hydrogenation. Additional dopants can be added for improved performance.		
46-2000	Palladium foil (99.95%) (7440-05-3) Pd; FW: 106.40; 0.1mm thick (~3g/50 x 50mm); m.p. 1552°; b.p. 3140°; d. 12.02	25 x 25mm 50 x 50mm
Palladium nanoparticles - surfactant and reactant-free (pure), manufactured via laser ablation (7440-05-3) See page 162		
46-2085	Palladium, 1% on polyethylenimine/SiO₂ ROYER Pd CATALYST (7440-05-3) Pd on support; 20-40 mesh beads	2g 10g 50g
46-2087	Palladium, 1% on polyethylenimine/SiO₂ ROYER Pd CATALYST (7440-05-3) Pd on support; 40-200 mesh pwdr.	2g 10g
46-2089	Palladium, 3% on polyethylenimine/SiO₂ ROYER Pd CATALYST (7440-05-3) Pd on support; 40-200 mesh pwdr.	2g 10g 50g
93-4631	Palladium powder (99.95%) (7440-05-3) HAZ Pd; FW: 106.40; -60 mesh; m.p. 1552°; b.p. 3140°; d. 12.02	1g 5g
93-4630	Palladium powder (99.999%) PURATREM (7440-05-3) HAZ Pd; FW: 106.40; -22 mesh; m.p. 1552°; b.p. 3140°; d. 12.02	1g 5g
46-2113	Palladium rod (99.95+%) (7440-05-3) Pd; FW: 106.40; 6.35 mm dia. (~7.72g/20mm); m.p. 1552°; b.p. 3140°; d. 12.02	20mm 100mm
46-2116	Palladium shot (99.9%) (7440-05-3) Pd; FW: 106.40; bluish-gray gran.; 6.35mm and down; m.p. 1552°; b.p. 3140°; d. 12.02	1g 5g
46-2090	Palladium, 5% on silica powder, reduced, dry (Escat™ 1351) (7440-05-3) gray pwdr. (d50=40 µm); SA: 400m ² /g Note: Sold in collaboration with BASF for research purposes only.	5g 25g
Technical Note: 1. Escat™ 1351 catalyst is recommended for selective hydrogenation reactions. The silica support enables totally different catalytic reactivity compared to carbon-based catalysts.		
46-2119	Palladium sponge (99.9%) (7440-05-3) Pd; FW: 106.40; bluish-gray pwdr.; m.p. 1552°; b.p. 3140°; d. 12.02	1g 5g
46-2123	Palladium sponge (99.95%) (7440-05-3) Pd; FW: 106.40; gray solid; m.p. 1552°; b.p. 3140°; d. 12.02	1g 5g
46-1711	Palladium, 0.5% on titanium silicate, 50% water-wet paste (NanoSelect LF 200) (7440-05-3) black solid (d50=25 µm) Note: Sold in collaboration with BASF for research purposes only.	5g 25g
Technical Note: 1. NanoSelect LF 200 is a lead-free, water-wet, catalyst containing metal crystallites of around 7 nm, and a mean particle size of 25 microns. The metal crystallites are supported on titanium silicate powder. The presence of nanometer-sized metal particles greatly increases the metal surface area available per gram of catalyst, and boosts catalytic activity. The catalyst is recommended for use in hydrogenation reactions leading to the partial reduction of functional groups. It is specifically suited for the selective hydrogenation of alkynes to alkenes, with a high selectivity for cis-alkenes.		
46-2125	Palladium wire (99.9%) (7440-05-3) Pd; FW: 106.40; 1.0mm dia. (~0.94g/10cm); m.p. 1552°; b.p. 3140°; d. 12.02	10cm 50cm

PALLADIUM (Compounds)

46-0025 **Acetato(2'-di-*t*-butylphosphino-1,1'-biphenyl-2-yl) palladium(II), min. 98% (577971-19-8)**
C₂₂H₂₈O₂PPd; FW: 462.86; off-white pwdr.
For detailed technical note visit strem.com.

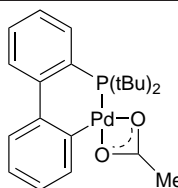

250mg
1g



PALLADIUM (Compounds)

46-0970 NEW	Acetato(2,9-dimethyl-1,10-phenanthroline)palladium(II) dimer bis(trifluoromethanesulfonate), 99% (959698-19-2) $C_{34}H_{30}F_6N_4O_{10}Pd_2S_2$; FW: 1045.59; dark orange pwr. For detailed technical note visit strem.com .		100mg 500mg
46-0039	Allylchloro[1,3-bis(2,6-di-i-propylphenyl)-4,5-dihydroimidazol-2-ylidene]palladium(II), 97% (478980-01-7) $C_{30}H_{43}ClN_2Pd$; FW: 573.55; white pwr. Note: Sold in collaboration with Umicore for research purposes only. Patent WO 2004014550, US 6,316,380 and EP 721 953 A1. For detailed technical note visit strem.com .		250mg 1g
46-0040	Allylchloro[1,3-bis(2,6-di-i-propylphenyl)imidazol-2-ylidene]palladium(II), 98% (478980-03-9) $C_{30}H_{41}ClN_2Pd$; FW: 571.53; white pwr.; m.p. 190° dec. Note: Sold in collaboration with Umicore for research purposes only. Patent WO 2004014550, US 6,316,380 and EP 721 953 A1.		250mg 1g
46-0045	Allylchloro[1,3-bis(2,4,6-trimethylphenyl)imidazol-2-ylidene]palladium(II), 98% (478980-04-0) $C_{24}H_{29}ClN_2Pd$; FW: 487.37; white pwr. Note: Sold in collaboration with Umicore for research purposes only. Patent WO 2004014550, US 6,316,380 and EP 721 953 A1. For detailed technical note visit strem.com .		250mg 1g
46-0065 NEW	Allyl(cyclopentadienyl)palladium(II), 98% (1271-03-0) $C_8H_{10}Pd$; FW: 212.58; red solid <i>air sensitive, (store cold)</i> For detailed technical note visit strem.com .		100mg 500mg 2g
46-0100	Allylpalladium chloride dimer, min. 98% (12012-95-2) $[C_3H_5PdCl]_2$; FW: 365.86; yellow xtl.; m.p. 120° dec. <i>air sensitive, (store cold)</i> Note: Palladium Kit component.		500mg 2g 10g
46-0101	Allylpalladium chloride dimer, supported on poly(ethylene glycol)polystyrene graft copolymer beads [~6% (C₃H₅PdCl)₂] $[C_3H_5PdCl]_2$; yellow solid <i>air sensitive, (store cold)</i> For detailed technical note visit strem.com .		250mg
46-1558	(2'-Amino-1,1'-biphenyl-2-yl)methanesulfonatopalladium(II) dimer, min. 98% (1435520-65-2) $C_{26}H_{26}N_2O_6Pd_2S_2$; FW: 739.47; off-white to tan pwr. <i>air sensitive</i> Note: Patents: PCT/US2013/030779, US Serial No. 13/799620		250mg 1g

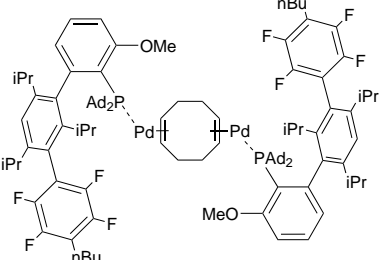
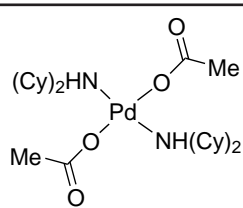
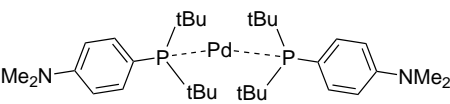
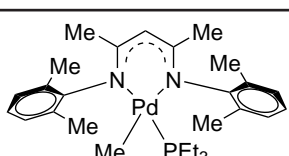
PALLADIUM (Compounds)

93-4601	Ammonium hexachloropalladate(IV), 99+% (19168-23-1) See page 5	
93-4602	Ammonium tetrachloropalladate(II), 99% (13820-40-1) See page 6	
02-1275	Ammonium tetrachloropalladate(II) (99.998%-Pd) PURATREM (13820-40-1) See page 6	
46-0700	Bis(acetonitrile)palladium(II) p-toluenesulfonate, 98% (114757-66-3) NEW C ₁₈ H ₂₀ N ₂ O ₆ S ₂ Pd; FW: 530.91; yellow pwdr. <i>air sensitive, (store cold)</i>	50mg 250mg
46-0200	Bis[1,2-bis(diphenylphosphino)ethane]palladium(0), 98% (31277-98-2) amp Pd[(C ₆ H ₅) ₂ PCH ₂ CH ₂ P(C ₆ H ₅) ₂] ₂ ; FW: 903.25; orange pwdr. <i>air sensitive</i>	1g 5g
46-0241	Bis[{2-(Diamantylphosphino)-3-methoxy-2',4',6'-tri-<i>i</i>-propyl-3'-(2,3,5,6-tetrafluoro-4-butylphenyl)-1,1'-biphenyl}palladium(0)]1,5-cyclooctadiene, [AIPhos Palladium complex] (1805783-51-0) NEW C ₁₁₂ H ₁₄₆ F ₈ O ₂ P ₂ Pd ₂ ; FW: 1951.13; yellow-green solid Note: Patents: US 6,395,916, US 6,307,087 For detailed technical note visit strem.com .	 50mg 250mg
96-3735	[1,1'-Bis(dialkyl/diarylphosphino)ferrocene]palladium(II) dichloro Catalyst Kit See page 468	
46-0210	Bis(dibenzylideneacetone)palladium(0) (32005-36-0) (C ₆ H ₅ CH=CHCOCH=CHC ₆ H ₅) ₂ Pd; FW: 575.00; purple pwdr. <i>air sensitive, moisture sensitive</i> For detailed technical note visit strem.com .	250mg 1g 5g 25g
46-0228	trans-Bis(dicyclohexylamine)bis(acetato)palladium(II) DAPCy (628339-96-8) Pd[(C ₆ H ₁₁) ₂ NH] ₂ (CH ₃ COO) ₂ ; FW: 587.14; yellow xtl. For detailed technical note visit strem.com .	 250mg 1g
46-0828	Bis[{4-(<i>N,N</i>-dimethylamino)phenyl}di-<i>t</i>-butylphosphino}palladium(0), min. 98% Pdamos (1233717-68-4) C ₃₇ H ₅₆ N ₂ P ₂ Pd; FW: 637.17; yellow-brown pwdr. <i>air sensitive</i> Note: Sold in collaboration with Johnson Matthey for research purposes only. For detailed technical note visit strem.com .	 250mg 1g
46-0230	N,N'-[Bis(2,6-dimethylphenyl)-1,3-dimethyl-1,3-propanediylidene](methyl)(triethylphosphine)palladium(II), min. 97% (1224879-40-6) C ₂₈ H ₄₃ N ₂ PPd; FW: 545.05; light brown pwdr. <i>air sensitive</i> For detailed technical note visit strem.com .	 50mg 250mg

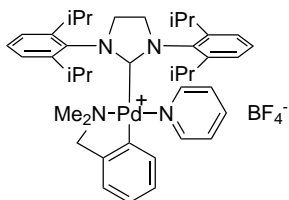
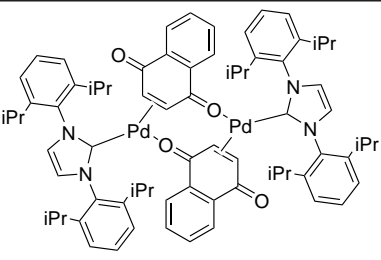
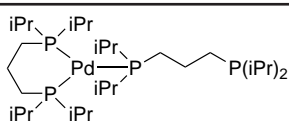
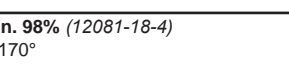
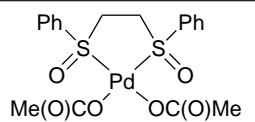
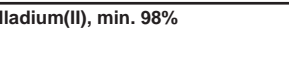
PALLADIUM (Compounds)

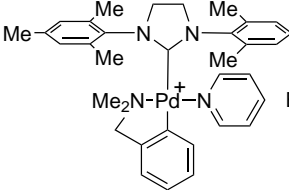
46-0226	<p>[1,3-Bis(2,6-di-<i>i</i>-propylphenyl)-4,5-dihydroimidazol-2-ylidene]{2-[(dimethylamino-<i>k</i>N)methyl]phenyl-<i>k</i>C}(pyridine)palladium(II) tetrafluoroborate, min. 97% PACC™ $[C_{41}H_{55}N_4Pd]BF_4$; FW: 797.13; pale yellow solid <i>air sensitive</i> Note: Sold under license from Kanata for research purposes only. US App. No. 61/324,022. For detailed technical note visit strem.com.</p>		100mg 500mg
46-0220	<p>1,3-Bis(2,6-di-<i>i</i>-propylphenyl)imidazol-2-ylidene(1,4-naphthoquinone)palladium(0) dimer, 96% (649736-75-4) $[(C_{27}H_{36}N_2)(C_{10}H_6O_2)Pd]_2$; FW: 1306.3; violet solid <i>air sensitive</i> Note: Sold in collaboration with Umicore for research purposes only. Patent WO 2004014550, US 6,316,380 and EP 721 953 A1. For detailed technical note visit strem.com.</p>		250mg 1g
46-0205	<p>[P,P'-1,3-Bis(di-<i>i</i>-propylphosphino)propane][P-1,3-bis(di-<i>i</i>-propylphosphino)propane]palladium(0), 98% (123333-45-9) $[CH_2(CH_2(P(C_3H_7)_2)_2)Pd(C_3H_7)_2PCH_2CH_2CH_2P(C_3H_7)_2]$; FW: 659.18; yellow oil to solid <i>air sensitive, (store cold)</i> For detailed technical note visit strem.com.</p>		250mg 1g
46-0240	<p>Bis(2-methylallyl)palladium chloride dimer, min. 98% (12081-18-4) $[C_4H_7PdCl]_2$; FW: 393.94; yellow powdr.; m.p. 168-170° <i>air sensitive</i></p>		500mg 2g
46-0245	<p>1,2-Bis(phenylsulfinyl)ethane palladium(II) acetate, min. 98% Christina White Catalyst (858971-43-4) $C_{18}H_{20}O_6PdS_2$; FW: 502.90; orange to brown powdr. <i>(store cold)</i> For detailed technical note visit strem.com.</p>		250mg 1g
46-0248	<p>Bis(2,2,6,6-tetramethyl-3,5-heptanedionato)palladium(II), min. 98% $[Pd(TMHD)_2]$ (15214-66-1) $Pd(C_{11}H_{19}O_2)_2$; FW: 472.95; orange powdr.</p>		1g 5g
46-0252	<p>Bis(tri-<i>t</i>-butylphosphine)palladium(0), 98% (53199-31-8) $Pd[P(C_4H_9)_3]_2$; FW: 511.06; off-white xtl. <i>air sensitive</i> For detailed technical note visit strem.com.</p>		250mg 1g 5g 25g
46-0260 amp	<p>Bis(tricyclohexylphosphine)palladium(0), 98% (33309-88-5) $Pd[P(C_6H_{11})_3]_2$; FW: 667.28; off-white xtl. <i>air sensitive, (store cold)</i></p>		250mg 1g 5g
46-0224	<p>[1,3-Bis(2,4,6-trimethylphenyl)-4,5-dihydroimidazol-2-ylidene]{2-[(dimethylamino-<i>k</i>N)methyl]phenyl-<i>k</i>C}(pyridine)palladium(II) tetrafluoroborate, min. 97% PACC™ $[C_{35}H_{43}N_4Pd]BF_4$; FW: 712.97; pale yellow solid <i>air sensitive</i> Note: Sold under license from Kanata for research purposes only. US App. No. 61/324,022. For detailed technical note visit strem.com.</p>		100mg 500mg

PALLADIUM (Compounds)

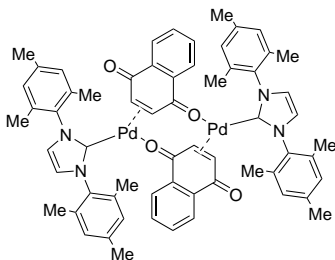
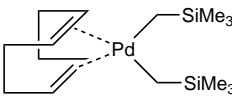
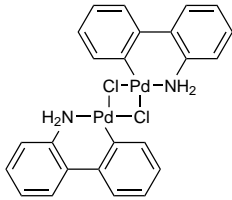
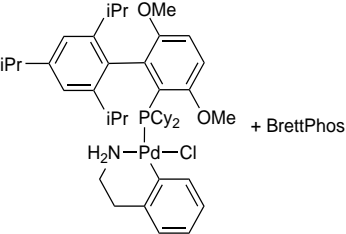
46-0265	1,3-Bis(2,4,6-trimethylphenyl)imidazol-2-ylidene(1,4-naphthoquinone)palladium(0) dimer, 96% (467220-49-1) $[(C_{21}H_{24}N_2)(C_{10}H_6O_2)Pd]_2$; FW: 1138.00; orange-red powdr. <i>air sensitive</i> Note: Sold in collaboration with Umicore for research purposes only. Patent WO 2004014550, US 6,316,380 and EP 721 953 A1. For detailed technical note visit strem.com .	250mg 1g	
46-0308 NEW	Bis[(trimethylsilyl)methyl](1,5-cyclooctadiene)palladium(II), 98% (225931-80-6) $C_{16}H_{34}PdSi_2$; FW: 389.03; gray powdr. <i>air sensitive, (store cold)</i>	250mg 1g	
46-0262	Bis(tri-<i>o</i>-tolylphosphine)palladium(0), min. 98% (69861-71-8) $C_{42}H_{42}P_2Pd$; FW: 715.15; yellow xtl. <i>air sensitive, (store cold)</i> For detailed technical note visit strem.com .	250mg 1g 5g	
96-5505	Buchwald Palladacycle Precatalyst Kit 2a (Methanesulfonato-2'-amino-1,1'-biphenyl-2-yl- Palladacycles Gen. 3) See page 471		
96-5508	Buchwald Palladacycle Precatalyst Kit 3 (Chloro- 2'-amino-1,1'-biphenyl-2-yl - Palladacycles Gen. 2) See page 470		
96-5503	Buchwald Palladacycle Precatalyst Kit 1 (Chloro-2-aminoethylphenyl- Palladacycles Gen. 1) See page 469		
96-5506	Buchwald Palladacycle Precatalyst Kit 2b (Methanesulfonato-2'-amino-1,1'-biphenyl-2-yl- Palladacycles Gen. 3) See page 473		
96-5512	Buchwald Palladacycle Precatalyst Kit 4 (Methanesulfonato-2'-methyl-amino-1,1'-biphenyl-2-yl- Palladacycles Gen. 4) See page 475		
46-1560	Chloro(2'-amino-1,1'-biphenyl-2-yl)palladium(II) dimer, min. 98% (847616-85-7) $C_{24}H_{20}Cl_2N_2Pd_2$; FW: 620.17; pale gray powdr. <i>air sensitive</i>	250mg 1g	
46-0367	Chloro{[BrettPhos][2-(2-aminoethylphenyl)]palladium(II)} /[BrettPhos] admixture (molar PdP/P = 1:1) white powdr. Note: Patents: US 6,395,916, US 6,307,087. For detailed technical note visit strem.com .	100mg 500mg	

PALLADIUM (Compounds)

46-0435 NEW	Chloro(1-t-butylindenyl)[2-(dicyclohexylphosphino)-2',6'-dimethoxy-1,1'-biphenyl]palladium(II) (1779569-07-1) $C_{30}H_{52}ClO_2PPd$; FW: 723.06; orange pwdr. Note: For research and development only. Not for use in humans. Patents 62/061,319. US 6,395,916, US 6,307,087. For detailed technical note visit strem.com .		100mg 500mg
46-0440 NEW	Chloro(1-t-butylindenyl)[2-(dicyclohexylphosphino)-2',6'-di-i-propoxy-1,1'-biphenyl]palladium(II) (1779569-08-2) $C_{43}H_{58}ClO_2PPd$; FW: 779.77; orange pwdr. Note: For research and development only. Not for use in humans. Patents 62/061,319. US 6,395,916, US 6,307,087. For detailed technical note visit strem.com .		100mg 500mg
46-0437 NEW	Chloro(1-t-butylindenyl)[2-(dicyclohexylphosphino)-2',4',6'-tri-i-propyl-1,1'-biphenyl]palladium(II) (1779569-06-0) $C_{46}H_{64}ClPPd$; FW: 789.85; orange pwdr. Note: For research and development only. Not for use in humans. Patents 62/061,319. US 6,395,916, US 6,307,087. For detailed technical note visit strem.com .		100mg 500mg
46-0815 NEW	Chloro(1-t-butylindenyl)[1,3-bis(2,6-di-i-propylphenyl)imidazol-2-yl]palladium(II), 98% (1779569-01-5) $C_{40}H_{41}ClN_2Pd$; FW: 691.61; orange pwdr. For detailed technical note visit strem.com .		100mg 500mg
46-0868 NEW	Chloro(1-t-butylindenyl)palladium(II) dimer, 98% (1779569-01-5) $C_{26}H_{30}Cl_2Pd_2$; FW: 626.26; brown pwdr. For detailed technical note visit strem.com .		100mg 500mg
46-0364	Chloro{[t-BuXPhos][2-(2-aminoethylphenyl)]palladium(II)}{[t-BuXPhos] admixture (molar Pd/P = 1:1) white pwdr. Note: Patents: US 6,395,916, US 6,307,087 For detailed technical note visit strem.com .		100mg 500mg

PALLADIUM (Compounds)

46-0264	<p>Chloro(2-di-<i>t</i>-butylphosphino-2',4',6'-tri-<i>i</i>-propyl-1,1'-biphenyl)[2-(2-aminoethyl)phenyl] palladium(II), min. 98% [t-BuXPhos Palladacycle Gen. 1] (1142811-12-8) $C_{37}H_{55}ClNPPd$; FW: 686.69; white powdr. Note: Patents: US 6,395,916, US 6,307,087. Buchwald Palladacycle Precatalyst Kit 1 component. For detailed technical note visit strem.com.</p>		100mg 500mg 2g 10g
46-0283	<p>Chloro(2-dicyclohexylphosphino-2',6'-dimethoxy-1,1'-biphenyl)(2'-amino-1,1'-biphenyl-2-yl) palladium(II) min. 98% [SPhos Palladacycle Gen. 2] (1375325-64-6) $C_{38}H_{45}ClNO_2PPd$; FW: 720.62; white powdr. Note: Patents: US 6,395,916, US 6,307,087. Buchwald Palladacycle Precatalyst Kit 3 component. For detailed technical note visit strem.com.</p>		250mg 1g 5g 25g
46-0269	<p>Chloro(2-dicyclohexylphosphino-2',6'-dimethoxy-1,1'-biphenyl)[2-(2-aminoethyl)phenyl]palladium(II) methyl-<i>t</i>-butylether adduct, min. 98% [SPhos Palladacycle Gen. 1] (1028206-58-7) $C_{34}H_{45}ClNO_2PPd$; FW: 672.57; white powdr. Note: Patents: US 6,395,916, US 6,307,087. Buchwald Palladacycle Precatalyst Kit 1 component. For detailed technical note visit strem.com.</p>		250mg 1g 5g
46-0292	<p>Chloro(2-dicyclohexylphosphino-3,6-dimethoxy-2',4',6'-tri-<i>i</i>-propyl-1,1'-biphenyl)(2'-amino-1,1'-biphenyl-2-yl)palladium(II), min. 98% [BrettPhos Palladacycle Gen. 2] (1451002-39-3) $C_{47}H_{63}ClNO_2PPd$; FW: 846.86; white powdr. Note: Patents: US 6,395,916, US 6,307,087. Buchwald Palladacycle Precatalyst Kit 3 component. For detailed technical note visit strem.com.</p>		100mg 500mg 2g
46-0267	<p>Chloro[2-(dicyclohexylphosphino)-3,6-dimethoxy-2',4',6'-tri-<i>i</i>-propyl-1,1'-biphenyl][2-(2-aminoethyl)phenyl]palladium(II), min. 98% [BrettPhos Palladacycle Gen. 1] (1148148-01-9) $C_{43}H_{63}ClNO_2PPd$; FW: 798.81; white powdr. Note: Patents US 6,395,916, US 6,307,087. Buchwald Palladacycle Precatalyst Kit 1 component. For detailed technical note visit strem.com.</p>		100mg 500mg 2g 10g

PALLADIUM (Compounds)

46-0232	Chloro[2-(dicyclohexylphosphino)-2'-(N,N-dimethylamino)-1,1'-biphenyl](2'-amino-1,1'-biphenyl-2-yl)palladium(II), min. 98% [DavePhos Palladacycle Gen. 2] $C_{38}H_{46}ClN_2PPd$; FW: 703.63; white pwdr. Note: Patents: US 6,395,916, US 6,307,087.		250mg 1g
46-0286	Chloro(2-dicyclohexylphosphino-2',6'-di-i-propoxy-1,1'-biphenyl)(2'-amino-1,1'-biphenyl-2-yl)palladium(II), min. 98% [RuPhos Palladacycle Gen. 2] (1375325-68-0) $C_{42}H_{53}ClNO_2PPd$; FW: 776.72; white pwdr. Note: Patents: US 6,395,916, US 6,307,087. Buchwald Palladacycle Precatalyst Kit 3 component. For detailed technical note visit strem.com .		250mg 1g 5g
46-0266	Chloro(2-dicyclohexylphosphino-2',6'-di-i-propoxy-1,1'-biphenyl)[2-(2-aminoethylphenyl)]palladium(II), methyl-t-butylether adduct, min. 98% [RuPhos Palladacycle Gen. 1] (1028206-60-1) $C_{38}H_{53}ClNO_2PPd$; FW: 728.68; off-white to beige pwdr. Note: Patents: US 6,395,916, US 6,307,087. Buchwald Palladacycle Precatalyst Kit 1 component. For detailed technical note visit strem.com .		100mg 500mg 2g 10g
46-0281	Chloro(2-dicyclohexylphosphino-2',4',6'-tri-i-propyl-1,1'-biphenyl)(2'-amino-1,1'-biphenyl-2-yl)palladium(II), min. 98% [XPhos Palladacycle Gen. 2] (1310584-14-5) $C_{45}H_{59}ClNPPd$; FW: 786.80; white pwdr. Note: Patents: US 6,395,916, US 6,307,087. Buchwald Palladacycle Precatalyst Kit 3 component. For detailed technical note visit strem.com .		250mg 1g 5g 25g
46-0268	Chloro(2-dicyclohexylphosphino-2',4',6'-tri-i-propyl-1,1'-biphenyl)[2-(2-aminoethylphenyl)]palladium(II) methyl-t-butylether adduct, min. 98% [XPhos Palladacycle Gen. 1] (1028206-56-5) $C_{41}H_{59}ClNPPd$; FW: 738.76; white pwdr. Note: Patents: US 6,395,916, US 6,307,087. Buchwald Palladacycle Precatalyst Kit 1 component. For detailed technical note visit strem.com .		250mg 1g 5g 25g

PALLADIUM (Compounds)

46-0342	<p>Chloro[[4-(N,N-dimethylamino)phenyl]di-<i>t</i>-butylphosphino}(2'-amino-1,1'-biphenyl-2-yl)palladium(II), min. 98% [Amphos Palladacycle Gen. 2] $C_{28}H_{38}ClN_2PPd$; FW: 575.46; beige to tan pwdr. Note: Patents: US 6,395,916, US 6,307,087 For detailed technical note visit strem.com.</p>		250mg 1g
46-0955	<p>Chloro[9,9-dimethyl-4,5-bis(diphenylphosphino)xanthene][2'-amino-1,1'-biphenyl]palladium(II) dichloromethane adduct, min. 98% [Xantphos Palladacycle Gen. 2] (1375325-77-1) $C_{51}H_{42}ClNOP_2Pd$; FW: 888.71; pale yellow pwdr. Note: Patents: US 6,395,916, US 6,307,087. For detailed technical note visit strem.com.</p>		500mg 2g
46-0270	<p>Chloro(di-2-norbornylphosphino)(2'-dimethylamino-1,1'-biphenyl-2-yl)palladium(II), 97% min. (359803-53-5) $[C_{12}H_{18}N(CH_3)_2]PdCl[HP(C_7H_{11})_2]$; FW: 560.45; beige pwdr.; m.p. -165° dec. Note: Sold in collaboration with Solvias for research purposes only. For detailed technical note visit strem.com.</p>		250mg 1g 5g
46-0272	<p>Chloro(di-2-norbornylphosphino)(2-dimethylaminomethylferrocen-1-yl)palladium(II), min. 97% (614753-51-4) $C_{27}H_{39}ClFeNPPd$; FW: 606.31; beige pwdr. Note: Sold in collaboration with Solvias for research purposes only. EP 1132361 (B1), 2001. For detailed technical note visit strem.com.</p>		250mg 1g 5g
46-1050	<p>Chloro[2-[1-(N-methoxyiminoethyl)phenyl] {[1,3-bis(2,6-di-<i>i</i>-propylphenyl)imidazole-2-ylidene]palladium(II) (1511859-41-8) $C_{36}H_{46}ClN_3OPd$; FW: 678.64; pale yellow pwdr. For detailed technical note visit strem.com.</p>		50mg 250mg
46-0255	<p>Chloromethyl(1,5-cyclooctadiene)palladium(II), 99% (63936-85-6) $PdCl(CH_3)(C_8H_{12})$; FW: 265.09; light grey pwdr.; m.p. 124-129° <i>air sensitive, (store cold)</i></p>		250mg 1g

PALLADIUM (Compounds)

46-1058 NEW	Chloro{2-[(1-(N-phenyl)iminoethyl)phenyl]{[1,3-bis(2,6-di-i-propylphenyl)imidazole-2-ylidene}palladium(II) (1905460-13-0) C ₄₁ H ₄₈ ClN ₃ Pd; FW: 724.71; pale yellow powdr. For detailed technical note visit strem.com .		50mg 250mg
46-0298 NEW	Chloro{[(1,2,3-η)-1-phenyl-2-propen-1-yl]{[1,3-bis[2,6-bis(diphenylmethyl)-4-methylphenyl]-2H-imidazol-2-ylidene}palladium(II) , min. 97% (1380314-24-8) C ₇₈ H ₆₅ ClN ₂ Pd; FW: 1172.24; yellow powdr. For detailed technical note visit strem.com .		100mg 500mg
46-0274	Chloro{[(1,2,3-η)-3-phenyl-2-propenyl][1,3-bis(2,6-di-i-propylphenyl)-4,5-dihydroimidazol-2-ylidene}palladium(II) , min. 97% (884879-24-7) C ₃₆ H ₄₇ ClN ₂ Pd; yellow microxtls. Note: Sold in collaboration with Umicore. WO 2004014550, US 6,316,380, EP 721 953 A1. For detailed technical note visit strem.com .		250mg 1g
46-0276	Chloro{[(1,2,3-η)-3-phenyl-2-propenyl][1,3-bis(2,6-di-i-propylphenyl)imidazol-2-ylidene}palladium(II) , min. 97% (884879-23-6) C ₃₆ H ₄₅ ClN ₂ Pd; FW: 647.65; yellow microxtls. Note: Sold in collaboration with Umicore for research purposes only. WO 2004014550 US 6,316,380, EP 721 953 A1. For detailed technical note visit strem.com .		250mg 1g
46-0366	Chloro{[RuPhos][2-(2-aminoethylphenyl)]palladium(II)}/[RuPhos] admixture (molar PdP/P = 1:1) white powdr. Note: Patents: US 6,395,916, US 6,307,087 For detailed technical note visit strem.com .		100mg 500mg
46-0369	Chloro{[S-Phos][2-(2-aminoethylphenyl)]palladium(II)}/[S-Phos] admixture (molar PdP/P = 1:1) white powdr. Note: Patents: US 6,395,916, US 6,307,087. For detailed technical note visit strem.com .		250mg 1g

PALLADIUM (Compounds)

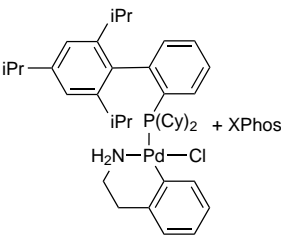
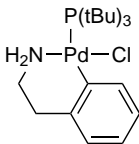
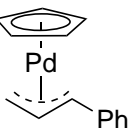
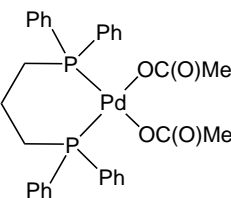
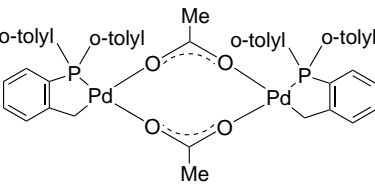
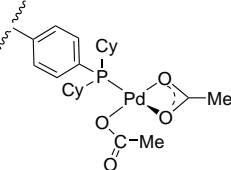
46-0368	Chloro[[X-Phos][2-(2-aminoethyl)phenyl] palladium(II)]/[X-Phos] admixture (molar PdP/P = 1:1) white powdr. Note: Patents: US 6,395,916 US 6,307,087. For detailed technical note visit strem.com .		250mg 1g
46-0288	Chloro(tri-t-butylphosphine)(2'-amino-1,1'-biphenyl-2-yl) palladium(II), min. 98% (1375325-71-5) $C_{24}H_{37}ClNPPd$; FW: 512.40; yellow powdr.; m.p. 158-160° For detailed technical note visit strem.com .		250mg 1g 5g
46-0285	Cyclopentadienyl[(1,2,3-n)-1-phenyl-2-propenyl]palladium(II), 98% (105333-10-6) $C_{14}H_{14}Pd$; FW: 288.68; purple-red xtl. <i>air sensitive, (store cold)</i> For detailed technical note visit strem.com .		100mg 500mg
46-0257	Diacetato[1,3-bis(diphenylphosphino)propane] palladium(II), 99% (149796-59-8) $C_{31}H_{32}O_4P_2Pd$; FW: 636.95; yellow-brown solid <i>moisture sensitive</i> For detailed technical note visit strem.com .		250mg 1g
46-0290	trans-Di(μ-acetato)bis[o-(di-o-tolylphosphino)benzyl]dipalladium(II), 97+% [cataCXium® C] (172418-32-5) $C_{21}H_{20}PPd(C_2H_3O_2)_2PdPC_{21}H_{20}$; FW: 937.65; yellow xtl. Note: Sold in collaboration with Solvias for research purposes. German Patent No. 4421753 granted to Solvias. Solvias cataCXium® Ligand Kit component. For detailed technical note visit strem.com .		250mg 1g 5g
46-0300	Diacetato bis(triphenylphosphine) palladium(II), 99% (14588-08-0) $(CH_3CO_2)_2Pd[P(C_6H_5)_3]_2$; FW: 749.07; light yellow xtl. <i>(store cold)</i>		1g 5g
46-1500	Di(acetato)dicyclohexyl-phenylphosphinepalladium (II) (~5% Pd) polymer-bound FibreCat™ orange-brown, fibrous solid Note: Limited quantities available.		1g 5g

Technical Note:

- Useful in the coupling of less active aryl chlorides with boronic acids.

PALLADIUM (Compounds)

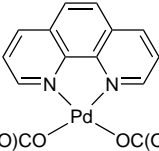
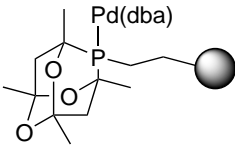
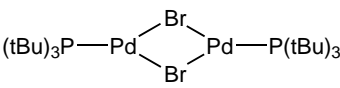
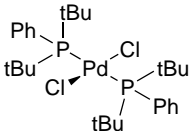
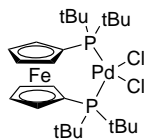
46-1565	Diacetato(1,10-phenanthroline)palladium(II), 99% (35679-81-3) $\text{Pd}(\text{CH}_3\text{COO})_2(\text{C}_{12}\text{H}_8\text{N}_2)$; FW: 404.71; yellow powdr.		250mg 1g 5g
46-0329	Diamminepalladium(II) nitrite solution (5% Pd) (14852-83-6) $\text{Pd}(\text{NH}_3)_2(\text{NO}_2)_2$; FW: 232.47; colorless to light yellow liq.		5g soln. 20g soln. 100g soln.
46-0180	Dibenzylideneacetonepalladium(0) 1,3,5,7-tetramethyl-2,4,6-trioxa-8-phosphaadamantane-8- ethyl Silica (PhosphonicS PAPd2r) pale green solid Note: Sold in collaboration with PhosphonicS Ltd. for research purposes only.		500mg 2g
Technical Note:			
1. Immobilized palladium heterogeneous catalyst successfully utilized in typical Suzuki and Heck reactions. The catalyst is effective for a wide range of substrates yielding coupled products in high yield. The catalyst can be simply filtered off and reused over several cycles, with no apparent loss in activity. Typical reactions using the homogeneous version of dibenzylideneacetonepalladium(0) phosphoadamantane can be found in <i>Org. Lett.</i> 2003 , 5, 6, <i>Tetrahedron Lett.</i> , 2004 , 45, 8319 and <i>J.Org.Chem.</i> , 2004 , 69, 5082.			
Particle size range: 60-200 microns			
Palladium loading: 0.01 to 0.03 mmol/g			
46-0355	Di-μ-bromobis(tri-t-butylphosphino)dipalladium(II) (185812-86-6) $\text{Pd}_2\text{Br}_2[\text{P}(\text{C}_4\text{H}_9)_3]_2$; FW: 777.28; dark-green xtl. <i>air sensitive, moisture sensitive, (store cold)</i> For detailed technical note visit strem.com .		100mg 500mg 2g
46-0360	trans-Dibromobis(triphenylphosphine)palladium(II), 99% (22180-53-6) $\text{C}_{36}\text{H}_{30}\text{Br}_2\text{P}_2\text{Pd}$; FW: 790.80; yellow powdr.		1g 5g
46-0665	Dibromo(1,5-cyclooctadiene)palladium(II), 99% (12145-47-0) $\text{PdBr}_2(\text{C}_8\text{H}_{12})$; FW: 374.41; orange solid		250mg 1g
46-0370	Dichlorobis(acetonitrile)palladium(II), 99% (14592-56-4) $\text{PdCl}_2(\text{CH}_3\text{CN})_2$; FW: 259.41; orange powdr. For detailed technical note visit strem.com .		1g 5g
46-0400	Dichlorobis(benzonitrile)palladium(II), 99% (14220-64-5) $\text{PdCl}_2(\text{C}_6\text{H}_5\text{CN})_2$; FW: 383.55; yellow to orange powdr.; m.p. 129-130° Note: Palladium Kit component. For detailed technical note visit strem.com .		1g 5g
46-0420	Dichlorobis(di-t-butylphenylphosphino)palladium(II), 99% (34409-44-4) $\text{C}_{28}\text{H}_{46}\text{Cl}_2\text{P}_2\text{Pd}$; FW: 621.94; colorless to pale-yellow solid For detailed technical note visit strem.com .		250mg 1g
46-0445	Dichloro[1,1'-bis(di-t-butylphosphino) ferrocene] palladium(II), 99% (95408-45-0) $[(\text{C}_5\text{H}_4\text{P}(\text{C}_4\text{H}_9)_2)_2\text{Fe}]\text{PdCl}_2$; FW: 651.75; dark purple xtl. Note: Dichloro[1,1'-bis(dialkyl/diarylphosphino)ferrocene] palladium(II) Catalyst Kit component.		100mg 500mg 2g 10g

PALLADIUM (Compounds)

46-0455	Dichloro[1,1'-bis(dicyclohexylphosphino)ferrocene] palladium(II), dichloromethane adduct, 99% (917511-90-1) $[(C_5H_4P(C_6H_{11})_2)_2Fe]PdCl_2$; FW: 755.89; red-orange microxtl. Note: Dichloro[1,1'-bis(dialkyl/diarylphosphino)ferrocene] palladium(II) Catalyst Kit component.		250mg 1g
Technical Note:			
1. Air-stable catalyst useful in the arylation of various ketones with aryl chlorides and aryl bromides.PRIVATE			
References:			
1. <i>Org. Proc. Res. Dev.</i> , 2008 , <i>12</i> , 522			
46-0188	Dichloro[(R)-(+)-2,2'-bis(di-2-furanylphosphino)-6,6'-dimethoxy-1,1'-biphenyl]palladium(II) NEW (1338245-54-7) $C_{30}H_{24}Cl_2O_8P_2Pd$; FW: 719.78; pale yellow pwdr. For detailed technical note visit strem.com .		50mg 250mg
46-0375	Di-μ-chlorobis[2-[(dimethylamino)methyl]phenyl]dipalladium, 99% (18987-59-2) $C_{18}H_{24}Cl_2N_2Pd_2$; FW: 552.14; yellow pwdr.		250mg 1g 5g
Technical Note:			
1. Useful starting material for the preparation of N-heterocyclic-carbene palladium complexes.			
46-0825	Dichlorobis[4-(N,N-dimethylamino)phenyl]di-t-butylphosphino]palladium(II), min. 98% PdAmphos (887919-35-9) $(C_{16}H_{26}NP)_2PdCl_2$; FW: 708.07; yellow pwdr. For detailed technical note visit strem.com .		250mg 1g 5g 25g
46-0870	Dichloro[(R)-(+)-2,2'-bis(diphenylphosphino)-1,1'-binaphthyl]palladium(II), min. 98% (115826-95-4) $PdCl_2(C_{44}H_{32}P_2)$; FW: 800.00; orange microxtls. For detailed technical note visit strem.com .		250mg 1g
46-0871	Dichloro[(S)-(-)-2,2'-bis(diphenylphosphino)-1,1'-binaphthyl]palladium(II), min. 98% (127593-28-6) $PdCl_2(C_{44}H_{32}P_2)$; FW: 800.00; orange microxtls.		250mg 1g
Technical Note:			
1. See 46-0870 (page 237)			
46-0468	Dichloro[1,4-bis(diphenylphosphino)butane]palladium(II), 99% (29964-62-3) NEW $C_{28}H_{28}Cl_2P_2Pd$; FW: 603.80; light-yellow pwdr. For detailed technical note visit strem.com .		1g 5g
46-0800	Dichloro(1,2-bis(diphenylphosphino)ethane)palladium(II), 98% (19978-61-1) $PdCl_2(C_6H_5)_2PCH_2CH_2P(C_6H_5)_2$; FW: 575.74; off-white pwdr.; m.p. > 300° <i>moisture sensitive</i>		1g 5g

PALLADIUM (Compounds)

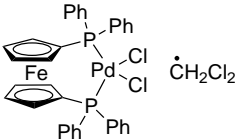
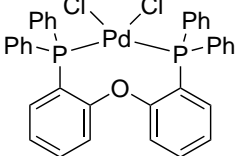
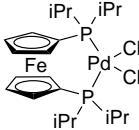
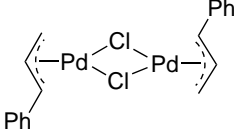
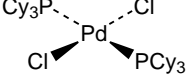
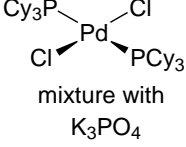
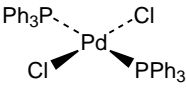
46-0450	Dichloro 1,1'-bis(diphenylphosphino)ferrocene palladium (II) dichloromethane, 99% (95464-05-4) [(C ₅ H ₄ P(C ₆ H ₅) ₂) ₂ Fe]PdCl ₂ ·CH ₂ Cl ₂ ; FW: 731.77 (816.65); orange-red powdr. Note: Dichloro[1,1'-bis(dialkyl/diarylphosphino)ferrocene]palladium(II) Catalyst Kit component. For detailed technical note visit strem.com .		1g 5g 25g
46-0463	Dichloro{bis[2-(diphenylphosphino)phenyl] ether}palladium(II), 98% (205319-06-8) C ₃₆ H ₂₈ Cl ₂ OP ₂ Pd; FW: 715.88; yellow powdr. For detailed technical note visit strem.com .		1g 5g
46-0850	Dichloro[1,3-bis(diphenylphosphino)propane]palladium(II), 98% (59831-02-6) PdCl ₂ (C ₆ H ₅) ₂ PCH ₂ CH ₂ CH ₂ P(C ₆ H ₅) ₂ ; FW: 589.77; pale yellow powdr.		1g 5g
46-0460	Dichloro[1,1'-bis(di-i-propylphosphino)ferrocene] palladium(II), 99% (215788-65-1) [(C ₅ H ₄ P(C ₃ H ₇) ₂) ₂ Fe]PdCl ₂ ; FW: 595.64; yellow-orange solid Note: Dichloro[1,1'-bis(dialkyl/diarylphosphino)ferrocene] palladium(II) Catalyst Kit component. For detailed technical note visit strem.com .		500mg 2g
46-0295	Di-μ-chlorobis[(1,2,3-η)-1-phenyl-2-propenyl] dipalladium(II), 98% (12131-44-1) [(C ₉ H ₉)ClPd] ₂ ; FW: 518.08; yellow xtl. <i>air sensitive</i> For detailed technical note visit strem.com .		500mg 2g
46-0520	trans-Dichlorobis(tricyclohexylphosphine)palladium(II), 99% (29934-17-6) PdCl ₂ [(C ₆ H ₁₁) ₃ P] ₂ ; FW: 738.19; light yellow powdr.		250mg 1g 5g
46-2040	trans-Dichlorobis(tricyclohexylphosphine)palladium(II)/potassium phosphate admixture [CatKit single-use vials - 6.62 wt% Pd complex] (29934-17-6) PdCl ₂ [(C ₆ H ₁₁) ₃ P] ₂ /K ₃ PO ₄ ; off-white powdr. Note: Each vial contains 453mg of admixture. Weight-percent of components: 6.62 wt% palladium complex Kit of CatKits - Single-Use Vials for low catalyst loading experiments Kit component..		5 x 1vial 25 x 1vial
46-0530	trans-Dichlorobis(triphenylphosphine)palladium(II), 99% (99.9+% Pd) (13965-03-2) PdCl ₂ (P(C ₆ H ₅) ₃) ₂ ; FW: 701.89; yellow powdr. For detailed technical note visit strem.com .		1g 5g 25g



Technical Note:

- Convenient, pre-weighed vial of palladium catalyst/base admixture useful for screening reactions. The vial contains 453mg of admixture, which will deliver 4 mole% of palladium catalyst and 2 equivalents of base, to a reaction using 1 mmole of substrate.

Weight-percent of components:

- 6.62 wt% palladium complex
93.38 wt% potassium phosphate

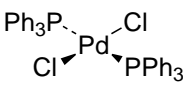
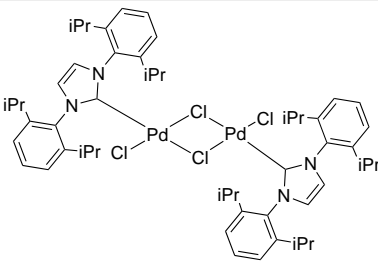
PALLADIUM (Compounds)

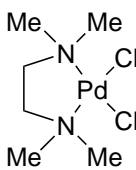
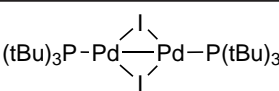
46-2038	trans-Dichlorobis(triphenylphosphine)palladium(II) potassium phosphate admixture [CatKit single-use vials - 6.32 wt% Pd complex] (13965-03-2) $\text{PdCl}_2[\text{P}(\text{C}_6\text{H}_5)_3]_2/\text{K}_3\text{PO}_4$; FW: 701.89; off-white powdr. Note: Each vial contains 453mg of admixture. Weight-percent of components: 6.32 wt% palladium complex Kit of CatKits - Single-Use Vials for low catalyst loading experiments Kit component.	 mixture with K_3PO_4	5 x 1vial 25 x 1vial
Technical Note:			
1. Convenient, pre-weighed vial of palladium catalyst/base admixture useful for screening reactions. The vial contains 453mg of admixture, which will deliver 4 mole% of palladium catalyst and 2 equivalents of base, to a reaction using 1 mmole of substrate.			
Weight-percent of components:			
6.32 wt% palladium complex			
93.68 wt% potassium phosphate			
46-0525	trans-Dichlorobis(tri-<i>o</i>-tolylphosphine)palladium(II), min. 95% (40691-33-6) $\text{PdCl}_2[\text{P}(\text{CH}_2\text{C}_6\text{H}_4)_3]_2$; FW: 786.07; yellow powdr.		1g 5g
46-0650	Dichloro(1,5-cyclooctadiene)palladium(II), 99% (12107-56-1) $\text{PdCl}_2(1,5\text{-C}_8\text{H}_{12})$; FW: 285.49; yellow xtl.; m.p. 205° dec.		250mg 1g 5g
93-4614	trans-Dichlorodiammine palladium(II), 99% (13782-33-7) $\text{Pd}(\text{NH}_3)_2\text{Cl}_2$; FW: 211.37; yellow powdr.		1g 5g
46-0860	Dichloro(di-μ-chloro)bis[1,3-bis(2,6-di-<i>i</i>-propylphenyl)imidazol-2-ylidene]dipalladium(II), 97% (444910-17-2) $\text{C}_{54}\text{H}_{72}\text{Cl}_4\text{N}_4\text{Pd}_2$; FW: 1131.83; orange to tan powdr. Note: Sold in collaboration with Umicore for research purposes only. Patent WO 2004014550, US 6,316,380 and EP 721 953 A1. For detailed technical note visit strem.com .		250mg 1g
46-0865	Dichloro[9,9-dimethyl-4,5-bis(diphenylphosphino)xanthene]palladium(II), min. 98% (205319-10-4) $\text{PdCl}_2(\text{C}_{39}\text{H}_{32}\text{OP}_2)$; FW: 755.94; yellow microxtls.		250mg 1g
46-0900	Dichloro(norbornadiene)palladium(II), 99% (12317-46-3) $\text{C}_7\text{H}_8\text{PdCl}_2$; FW: 269.46; yellow to orange powdr.		250mg 1g
Technical Note:			
1. Useful starting material for the in situ preparation of a variety of chiral and achiral palladium catalysts.			
References:			
1. <i>J. Am. Chem. Soc.</i> , 2001 , 123, 7725.			
2. <i>J. Org. Chem.</i> , 2009 , 74, 1407.			
3. <i>Angew. Chem. Int. Ed.</i> , 2008 , 47, 6367.			
46-0950	cis-Dichloro(N,N,N',N'-tetramethylethylenediamine) palladium(II), 99% (14267-08-4) $\text{C}_6\text{H}_{16}\text{Cl}_2\text{N}_2\text{Pd}$; FW: 293.53; yellow powdr.		250mg 1g
46-0310	Di-μ-iodobis(tri-<i>t</i>-butylphosphino) dipalladium(I), 98% (166445-62-1) $\text{C}_{24}\text{H}_{54}\text{I}_2\text{P}_2\text{Pd}_2$; FW: 871.28; black solid For detailed technical note visit strem.com .		250mg 1g

PALLADIUM (Compounds)

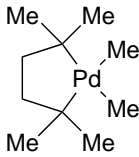
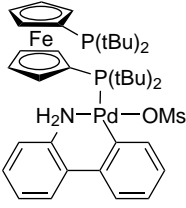
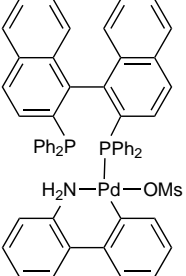
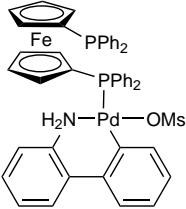
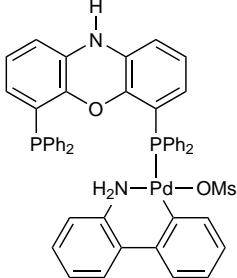
46-0952	cis-Dimethyl(N,N,N',N'-tetramethylethylenediamine)palladium(II), 99% (113822-11-0) $C_8H_{22}N_2Pd$; FW: 252.69; white to off-white powder. <i>light sensitive, (store cold)</i>		250mg 1g
96-3790	Kit of CatKits - Single-Use Vials for Low Catalyst Loading Experiments See page 486		
46-2158 NEW	Methanesulfonato(1,1'-bis(di-t-butylphosphino)ferrocene)(2'-amino-1,1'-biphenyl-2-yl)palladium(II), min. 98% [DTBPF Palladacycle Gen. 3] $C_{38}H_{57}FeNO_3P_2PdS$; FW: 844.16; orange powder. Note: Patents: PCT/US2013/030779, US Serial No. 13/799620		250mg 1g 5g
46-2153 NEW	Methanesulfonato[2,2'-bis(diphenylphosphino)-1,1'-binaphthyl](2'-amino-1,1'-biphenyl-2-yl)palladium(II), min. 98% [BINAP Palladacycle Gen. 3] $C_{57}H_{45}NO_3P_2PdS$; FW: 992.41; off-white powder. Note: Patents: PCT/US2013/030779, US Serial No. 13/799620. For detailed technical note visit strem.com .		250mg 1g 5g
46-2128 NEW	Methanesulfonato[1,1'-bis(diphenylphosphino)ferrocene](2'-amino-1,1'-biphenyl-2-yl)palladium(II), min. 98% [DPPF Palladacycle Gen. 3] (1445086-28-1) $C_{47}H_{41}FeNO_3P_2PdS$; FW: 924.11; yellow powder. Note: Patents: PCT/US2013/030779, US Serial No. 13/799620		250mg 1g 5g
46-0959 NEW	Methanesulfonato[4,6-bis(diphenylphosphino)phenoxazine](2'-amino-1,1'-biphenyl-2-yl)palladium(II), 98% [NiXantphos Palladacycle Gen. 3] (1602922-03-1) $C_{40}H_{40}N_2O_4P_2PdS$; FW: 921.29; light green yellow solid Note: Patents: PCT/US2013/030779, US Serial No. 13/799620 For detailed technical note visit strem.com .		100mg 500mg 2g

PALLADIUM (Compounds)

46-0340	Methanesulfonato[2-bis(3,5-di(trifluoromethyl)phenyl)phosphino]-3,6-dimethoxy-2',4',6'-tri-<i>i</i>-propyl-1,1'-biphenyl](2'-amino-1,1'-biphenyl-2-yl)palladium(II), min. 98% [JackiePhos Palladacycle Gen. 3] $C_{55}H_{50}F_{12}NO_3PPdS$; FW: 1166.39; white powdr. Note: Patents: PCT/US2013/030779, US Serial No. 13/799620. Buchwald Palladacycle Precatalyst Kit 2 component. For detailed technical note visit strem.com .		100mg 500mg 2g
46-0278 NEW	Methanesulfonato(diadamantyl-<i>n</i>-butylphosphino)-2'-amino-1,1'-biphenyl-2-yl)palladium(II) dichloromethane adduct, min. 95% [cataCXium® A Palladacycle Gen. 3] $C_{37}H_{52}NO_3PPdS$; FW: 728.27; off-white powdr. Note: Patents: PCT/US2013/030779, US Serial No. 13/799620. Patent WO 0210178. For detailed technical note visit strem.com .		250mg 1g 5g
46-0480 NEW	Methanesulfonato[2-(di-1-adamantylphosphino)-3,6-dimethoxy-2',4',6'-tri-<i>i</i>-propyl-1,1'-biphenyl](2'-amino-1,1'-biphenyl-2-yl)palladium(II), min. 98% [AdBrettPhos Palladacycle Gen. 3] (1445972-29-1) $C_{56}H_{74}NO_3PPdS$; FW: 1010.65; brown to green solid Note: Patents: PCT/US2013/030779, US Serial No. 13/799620 For detailed technical note visit strem.com .		50mg 250mg 1g 5g
46-0935 NEW	Methanesulfonato(<i>N</i>-[2-(di-1-adamantylphosphino)phenyl]morpholine)(2'-amino-1,1'-biphenyl-2-yl)palladium(II) dichloromethane adduct, min. 98% [Mor-Dalpos Palladacycle Gen. 3] $C_{43}H_{55}N_4O_4PPdS$; FW: 833.37; Beige to brown solid Note: Patents: PCT/US2013/030779, US Serial No. 13/799620		250mg 1g
46-0940 NEW	Methanesulfonato(<i>N</i>-[2-(di-1-adamantylphosphino)phenyl]morpholine)(2'-methylamino-1,1'-biphenyl-2-yl)palladium(II) dichloromethane adduct, min. 98% MorDalpos Palladacycle Gen. 4 $C_{44}H_{57}N_2O_4PPdS$; FW: 847.39; off-white to gray solid Note: Patents: PCT/US2013/030779, US Serial No. 13/799620.		250mg 1g
46-0365	Methanesulfonato[di-<i>t</i>-butyl(<i>n</i>-butyl)phosphine](2'-amino-1,1'-biphenyl-2-yl)palladium(II) dichloromethane adduct, min. 98% [P(<i>t</i>-Bu)₂(<i>n</i>-Bu) Palladacycle Gen. 3] (1445086-17-8) $C_{25}H_{40}NO_3PPdS$; FW: 572.05; white to off-white powdr. Note: Patents: PCT/US2013/030779, US Serial No. 13/799620.		250mg 1g 5g

PALLADIUM (Compounds)

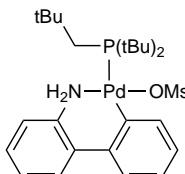
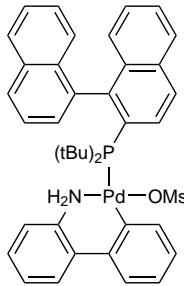
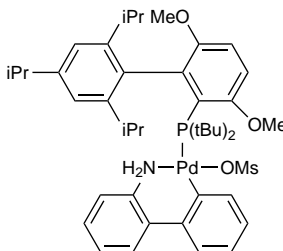
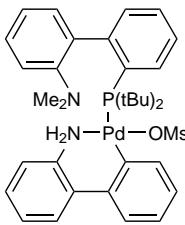
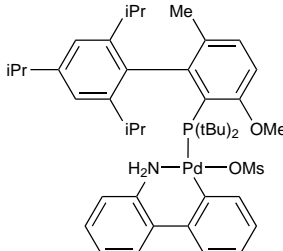
46-0358	Methanesulfonato(di-t-butylneopentylphosphine) (2'-amino-1,1'-biphenyl-2-yl)palladium(II), min. 98% [DTBNpP Palladacycle Gen. 3] (1507403-89-5) $C_{26}H_{42}NO_3PPdS$; FW: 586.08; white to off-white powdr. Note: Patents: PCT/US2013/030779, US Serial No. 13/799620.		250mg 1g 5g
46-0357	Methanesulfonato(2-di-t-butylphosphino-1,1'-binaphthyl) (2'-amino-1,1'-biphenyl-2-yl)palladium(II), min. 95% [TrixiePhos Palladacycle Gen. 3] $C_{41}H_{44}NO_3PPdS$; FW: 768.25; white to off-white powdr. Note: Patents: PCT/US2013/030779, US Serial No. 13/799620		100mg 500mg 2g
46-0325	Methanesulfonato(2-(di-t-butylphosphino)-3,6-dimethoxy-2',4',6'-tri-i-propyl-1,1'-biphenyl)(2'-amino-1,1'-biphenyl-2-yl)palladium(II), dichloromethane adduct, min. 98% [t-BuBrettPhos Palladacycle Gen. 3] (1536473-72-9) $C_{44}H_{62}NO_3PPdS$; FW: 854.43; brown-green solid Note: Patents: PCT/US2013/030779, US Serial No. 13/799620. Buchwald Palladacycle Precatalyst Kit 2 component. For detailed technical note visit strem.com .		100mg 500mg 2g 10g
46-2135	Methanesulfonato[2-(di-t-butylphosphino)-2'-(N,N-dimethylamino)-1,1'-biphenyl](2'-amino-1,1'-biphenyl-2-yl)palladium(II) dichloromethane adduct, min. 98% [t-BuDavePhos Palladacycle Gen. 3] (1445085-92-6) $C_{35}H_{45}N_2O_3PPdS \cdot CH_2Cl_2$; FW: 711.20; green-yellow powdr. Note: Patents: PCT/US2013/030779, US Serial No. 13/799620		250mg 1g 5g
46-0335	Methanesulfonato(2-(di-t-butylphosphino)-3-methoxy-6-methyl-2',4',6'-tri-i-propyl-1,1'-biphenyl)(2'-amino-1,1'-biphenyl-2-yl)palladium(II), min. 98% [RockPhos Palladacycle Gen. 3] (2009020-38-4) $C_{44}H_{62}NO_4PPdS$; FW: 838.43; brown powdr. Note: Patents: PCT/US2013/030779, US Serial No. 13/799620. Buchwald Palladacycle Precatalyst Kit 2 component. For detailed technical note visit strem.com .		100mg 500mg 2g 10g

PALLADIUM (Compounds)

46-2163 NEW	Methanesulfonato(2-di-t-butylphosphino-3,4,5,6-tetramethyl-2',4',6'-tri-i-propylbiphenyl)(2'-amino-1,1'-biphenyl-2-yl)palladium(II), min. 95% [Me4 t-BuIXPhos Palladacycle Gen. 3] (1507403-85-1) $C_{46}H_{66}NO_3PPdS$; FW: 850.48; dark green pwdr. Note: Patents: PCT/US2013/030779, US Serial No. 13/799620 For detailed technical note visit strem.com .		100mg 500mg 2g
46-0323	Methanesulfonato(2-di-t-butylphosphino-2',4',6'-tri-i-propyl-1,1'-biphenyl)(2'-amino-1,1'-biphenyl-2-yl)palladium(II), min. 98% [t-BuXPhos Palladacycle Gen. 3] (1447963-75-8) $C_{42}H_{58}NO_3PPdS$; FW: 794.38; yellow pwdr. Note: Patents: PCT/US2013/030779, US Serial No. 13/799620. Buchwald Palladacycle Precatalyst Kit 2 component. For detailed technical note visit strem.com .		250mg 1g
46-0330 NEW	Methanesulfonato(2-di-t-butylphosphino-2',4',6'-tri-i-propyl-1,1'-biphenyl)(2'-methylamino-1,1'-biphenyl-2-yl)palladium(II) dichloromethane adduct, min. 98% [t-BuXphos Palladacycle Gen. 4] (1599466-89-3) $C_{43}H_{60}NO_3PPdS$; FW: 808.40; off-white to gray pwdr. Note: Patents: PCT/US2013/030779, US Serial No. 13/799620. Buchwald Palladacycle Precatalyst Kit 4 (Methanesulfonato-2'-methylamino-1,1'-biphenyl-2-yl)-Palladacycles Gen. 4) component. For detailed technical note visit strem.com .		250mg 1g 5g
46-0487 NEW	Methanesulfonato(2-dicyclohexylphosphino-2',6'-bis(dimethylamino)-1,1'-biphenyl)(2'-amino-1,1'-biphenyl-2-yl)palladium(II), 98% [CPhos Palladacycle Gen. 3] (1447963-73-6) $C_{41}H_{54}N_2O_3PPdS$; FW: 806.35; white to off-white pwdr. Note: Patents: PCT/US2013/030779, US Serial No. 13/799620. For detailed technical note visit strem.com .		100mg 500mg 2g
46-0318	Methanesulfonato(2-dicyclohexylphosphino-2',6'-dimethoxy-1,1'-biphenyl)(2'-amino-1,1'-biphenyl-2-yl)palladium(II) dichloromethane adduct min. 98% [SPhos Palladacycle Gen. 3] (1445085-82-4) $C_{39}H_{48}NO_5PPdS$; FW: 780.26; pale yellow solid Note: Patents: PCT/US2013/030779, US Serial No. 13/799620. Buchwald Palladacycle Precatalyst Kit 2 component. For detailed technical note visit strem.com .		250mg 1g 5g 25g

PALLADIUM (Compounds)

46-0380 NEW	Methanesulfonato(2-dicyclohexylphosphino-2',6'-dimethoxy-1,1'-biphenyl)(2'-methylamino-1,1'-biphenyl-2-yl)palladium(II) dichloromethane adduct min. 98% [SPHos Palladacycle Gen. 4] (1599466-87-1) $C_{40}H_{50}NO_3PPdS$; FW: 794.29; off-white to tan pwdr. Note: Patents: PCT/US2013/030779, US Serial No. 13/799620. Buchwald Palladacycle Precatalyst Kit 4 (Methanesulfonato-2'-methylamino-1,1'-biphenyl-2-yl-Palladacycles Gen. 4) component. For detailed technical note visit strem.com .		250mg 1g 5g
46-0322	Methanesulfonato(2-dicyclohexylphosphino-3,6-dimethoxy-2',4',6'-tri-<i>i</i>-propyl-1,1'-biphenyl)(2'-amino-1,1'-biphenyl-2-yl)palladium(II), min. 98% [BrettPhos Palladacycle Gen. 3] (1470372-59-8) $C_{48}H_{66}NO_3PPdS$; FW: 906.50; beige pwdr. Note: Patents: PCT/US2013/030779, US Serial No. 13/799620. Buchwald Palladacycle Precatalyst Kit 2 component. For detailed technical note visit strem.com .		100mg 500mg 2g 10g
46-0333 NEW	Methanesulfonato(2-dicyclohexylphosphino-3,6-dimethoxy-2',4',6'-tri-<i>i</i>-propyl-1,1'-biphenyl)(2'-methylamino-1,1'-biphenyl-2-yl)palladium(II), min. 98% [BrettPhos Palladacycle Gen. 4] (1599466-83-7) $C_{48}H_{68}NO_3PPdS$; FW: 920.53; off-white to beige pwdr. Note: Patents: PCT/US2013/030779, US Serial No. 13/799620. Buchwald Palladacycle Precatalyst Kit 4 (Methanesulfonato-2'-methylamino-1,1'-biphenyl-2-yl-Palladacycles Gen. 4) component. For detailed technical note visit strem.com .		250mg 1g 5g
46-0237	Methanesulfonato[2-(dicyclohexylphosphino)-2'-(<i>N,N</i>-dimethylamino)-1,1'-biphenyl](2'-amino-1,1'-biphenyl-2-yl)palladium(II) CH₂Cl₂ adduct, min. 98% [DavePhos Palladacycle Gen. 3] (1445085-87-9) $C_{38}H_{49}N_2O_3PPdS$; FW: 763.28; white pwdr. Note: Patents: PCT/US2013/030779, US Serial No. 13/799620.		250mg 1g
46-0314	Methanesulfonato(2-dicyclohexylphosphino-2',6'-di-<i>i</i>-propoxy-1,1'-biphenyl)(2'-amino-1,1'-biphenyl-2-yl)palladium(II), min. 98% [RuPhos Palladacycle Gen. 3] (1445085-77-7) $C_{43}H_{56}NO_3PPdS$; FW: 836.37; white pwdr. Note: Patents: PCT/US2013/030779, US Serial No. 13/799620. Buchwald Palladacycle Precatalyst Kit 2 component. For detailed technical note visit strem.com .		250mg 1g 5g

PALLADIUM (Compounds)

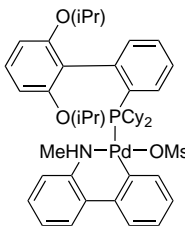
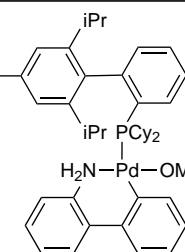
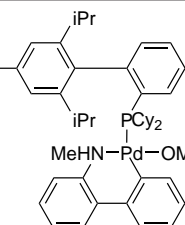
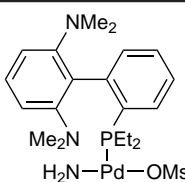
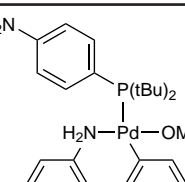
46-0395 NEW	Methanesulfonato(2-dicyclohexylphosphino-2',6'-di-i-propoxy-1,1'-biphenyl)(2'-methylamino-1,1'-biphenyl-2-yl)palladium(II), min. 98% [RuPhos Palladacycle Gen. 4] (1599466-85-9) $C_{44}H_{58}NO_3PPdS$; FW: 850.40; white powdr. Note: Patents: PCT/US2013/030779, US Serial No. 13/799620 Buchwald Palladacycle Precatalyst Kit 4 (Methanesulfonato-2'-methylamino-1,1'-biphenyl-2-yl-Palladacycles Gen. 4) component. For detailed technical note visit strem.com .		250mg 1g 5g
46-0353	Methanesulfonato((R)-(-)-1-[(S)-2-(dicyclohexylphosphino)ferrocenyl]ethyldi-t-butylphosphine)(2'-amino-1,1'-biphenyl-2-yl)palladium(II), min. 98% [Josiphos Palladacycle Gen. 3] (1702311-34-9) $C_{46}H_{65}FeNO_3P_2PdS$; FW: 924.28; red-orange solid Note: Patents: PCT/US2013/030779, US Serial No. 13/799620. For detailed technical note visit strem.com .		100mg 500mg 2g 10g
46-0320	Methanesulfonato(2-dicyclohexylphosphino-2',4',6'-tri-i-propyl-1,1'-biphenyl)(2'-amino-1,1'-biphenyl-2-yl)palladium(II) dichloromethane adduct, min. 98% [Xphos Palladacycle Gen. 3] (1445085-55-1) $C_{46}H_{62}NO_3PPdS$; FW: 846.45; white to off-white powdr. Note: Patents: PCT/US2013/030779, US Serial No. 13/799620. Buchwald Palladacycle Precatalyst Kit 2 component. For detailed technical note visit strem.com .		250mg 1g 5g
46-0327 NEW	Methanesulfonato(2-dicyclohexylphosphino-2',4',6'-tri-i-propyl-1,1'-biphenyl)(2'-methylamino-1,1'-biphenyl-2-yl)palladium(II), min. 98% [XPhos Palladacycle Gen. 4] (1599466-81-5) $C_{47}H_{64}NO_3PPdS$; FW: 860.48; white powdr. Note: Patents: PCT/US2013/030779, US Serial No. 13/799620. Buchwald Palladacycle Precatalyst Kit 4 (Methanesulfonato-2'-methylamino-1,1'-biphenyl-2-yl-Palladacycles Gen. 4) component. For detailed technical note visit strem.com .		250mg 1g 5g
46-0348 NEW	Methanesulfonato[2-diethylphosphino-2',6'-bis(dimethylamino)-1,1'-biphenyl](2'-amino-1,1'-biphenyl-2-yl)palladium(II), min. 98% [EtCPhos Palladacycle Gen. 3] $C_{33}H_{42}N_3O_3PPdS$; FW: 698.17; white to off-white solid Note: Patents: PCT/US2013/030779, US Serial No. 13/799620 For detailed technical note visit strem.com .		50mg 250mg 1g
46-0345	Methanesulfonato[4-(N,N-dimethylamino)phenyl]di-t-butylphosphino(2'-amino-1,1'-biphenyl-2-yl)palladium(II), min. 98% [Amphos Palladacycle Gen. 3] (1820817-64-8) $C_{26}H_{41}N_2O_3PPdS$; FW: 635.11; beige to tan powdr. Note: Patents: PCT/US2013/030779, US Serial No. 13/799620. For detailed technical note visit strem.com .		250mg 1g 5g

PALLADIUM (Compounds)

46-0957	Methanesulfonato[9,9-dimethyl-4,5-bis(diphenylphosphino)xanthene][2'-amino-1,1'-biphenyl] palladium(II) dichloromethane adduct, min. 98% [Xantphos Palladacycle Gen. 3] (1445085-97-1) $C_{55}H_{45}NO_4P_2PdS$; FW: 948.35; pale yellow powdr. Note: Patents: PCT/US2013/030779, US Serial No. 13/799620. For detailed technical note visit strem.com .		500mg 2g
46-0388	Methanesulfonato[9,9-dimethyl-4,5-bis(diphenylphosphino)xanthene][2'-methylamino-1,1'-biphenyl-2-yl]palladium(II), 98% [Xantphos Palladacycle Gen. 4] (1621274-19-8) $C_{53}H_{47}NO_4P_2PdS$; FW: 962.38; yellow solid Note: Patents: PCT/US2013/030779, US Serial No. 13/799620. Buchwald Palladacycle Precatalyst Kit 4 (Methanesulfonato-2'-methylamino-1,1'-biphenyl-2-yl- Palladacycles Gen. 4) component. For detailed technical note visit strem.com .		250mg 1g 5g
46-0392	Methanesulfonato(1,3,5,7-tetramethyl-8-phenyl-2,4,6-trioxo-8-phosphaadamantane)(2'-amino-1,1'-biphenyl-2-yl)palladium(II) dichloromethane adduct, min. 98% [MeCgPPh Palladacycle Gen. 3] $C_{26}H_{34}NO_6PPdS \cdot CH_2Cl_2$; FW: 662.04; white to tan powdr. <i>air sensitive, moisture sensitive</i> Note: Patents: PCT/US2013/030779, US Serial No. 13/799620		500mg 2g
46-0387	Methanesulfonato(tri-<i>t</i>-butylphosphino)(2'-amino-1,1'-biphenyl-2-yl)palladium(II), 98% [P(<i>t</i>-Bu)₃ Palladacycle Gen. 3] (1445086-17-8) $C_{25}H_{40}NO_3PPdS$; FW: 572.05; white powdr. Note: Patents: PCT/US2013/030779, US Serial No. 13/799620. For detailed technical note visit strem.com .		250mg 1g 5g
46-0385	Methanesulfonato(tri-<i>t</i>-butylphosphino)(2'-methylamino-1,1'-biphenyl-2-yl)palladium(II), 98% [P(<i>t</i>-Bu)₃ Palladacycle Gen. 4] (1621274-11-0) $C_{26}H_{42}NO_3PPdS$; FW: 586.08; tan to yellow powdr. Note: Patents: PCT/US2013/030779, US Serial No. 13/799620. Buchwald Palladacycle Precatalyst Kit 4 (Methanesulfonato-2'-methylamino-1,1'-biphenyl-2-yl- Palladacycles Gen. 4) component. For detailed technical note visit strem.com .		250mg 1g 5g
46-0239	Methanesulfonato(tricyclohexylphosphine)(2'-amino-1,1'-biphenyl-2-yl)palladium(II) dichloromethane adduct, min. 98% [PCy₃ Palladacycle Gen. 3] (1445086-12-3) $C_{31}H_{46}NO_3PPdS$; FW: 650.16; off-white to beige powdr. Note: Patents: PCT/US2013/030779, US Serial No. 13/799620. For detailed technical note visit strem.com .		250mg 1g 5g

PALLADIUM (Compounds)

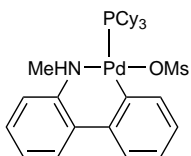
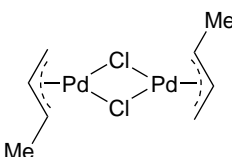
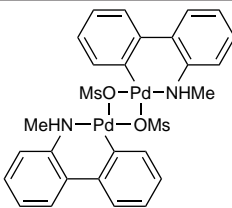
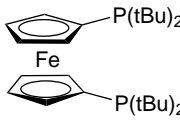
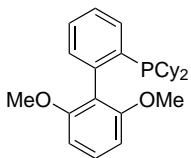
46-0379 NEW	Methanesulfonato(tricyclohexylphosphino) (2'-methylamino-1,1'-biphenyl-2-yl)palladium(II), 98% [PCy₃ Palladacycle Gen. 4] C ₃₂ H ₄₈ NO ₃ PPdS; FW: 664.19; white powdr. Note: Patents: PCT/US2013/030779, US Serial No. 13/799620. Buchwald Palladacycle Precatalyst Kit 4 (Methanesulfonato-2'-methylamino-1,1'-biphenyl-2-yl-Palladacycles Gen. 4) component. For detailed technical note visit strem.com .		250mg 1g 5g
46-0275	(1-Methylallyl)palladium chloride dimer, 99% (12081-22-0) [C ₄ H ₇ PdCl] ₂ ; FW: 393.94; yellow powdr. <i>air sensitive</i>		500mg 2g
46-1553 NEW	(2'-Methylamino-1,1'-biphenyl-2-yl) methanesulfonatopalladium(II) dimer, min. 98% (1581285-85-9) C ₂₈ H ₃₀ N ₂ O ₆ Pd ₂ S ₂ ; FW: 767.52; light gray powdr. <i>air sensitive</i> Note: Patents: PCT/US2013/030779, US Serial No. 13/799620 For detailed technical note visit strem.com .		500mg 2g
46-1780	Palladium(II) acetate, min. 98% (99.9+%-Pd) (3375-31-3) Pd ₃ (OOCCH ₃) ₆ ; FW: 673.52; golden-brown xtl. Note: Palladium Kit component. For detailed technical note visit strem.com .		1g 5g 25g
46-1781	Palladium(II) acetate, 99+% (99.95+%-Pd) (3375-31-3) Pd ₃ (OOCCH ₃) ₆ ; FW: 673.52; golden-brown xtl. For detailed technical note visit strem.com .		1g 5g 25g
46-2030	Palladium(II) acetate/1,1'-bis(di-t-butylphosphino) ferrocene/potassium phosphate admixture [CatKit single-use vials - 2.02 wt% Pd(OAc)₂] off-white powdr. Note: Each vial contains 453mg of admixture. Weight-percent of components: 2.02 wt% palladium acetate; 4.28 wt% phosphine ligand; 93.7 wt% potassium phosphate Kit of CatKits - Single-Use Vials for low catalyst loading experiments Kit component..		5 x 1vial 25 x 1vial
		mixture with Pd(OAc) ₂ /K ₃ PO ₄	
Technical Note:	1. Convenient, pre-weighed vial of palladium catalyst/base admixture useful for screening reactions. The vial contains 453mg of admixture, which will deliver 4 mole% of palladium catalyst and 2 equivalents of base, to a reaction using 1 mmole of substrate.		
46-2033	Palladium(II) acetate/2-dicyclohexylphosphino-2,6-dimethoxy-1,1'-biphenyl (SPhos)/potassium phosphate admixture [CatKit single-use vials - 1.96 wt% Pd(OAc)₂] off-white powdr. Note: Patents: US 6,395,916, US 6,307,087. Each vial contains 453mg of admixture. Weight-percent of components: 1.96 wt% palladium acetate; 7.17 wt% phosphine ligand; 90.8 wt% potassium phosphate Kit of CatKits - Single-Use Vials for low catalyst loading experiments Kit component. For detailed technical note visit strem.com .		5 x 1vial 25 x 1vial
		mixture with Pd(OAc) ₂ /K ₃ PO ₄	
46-1800	Palladium(II) acetylacetonate, 99% (14024-61-4) Pd(C ₈ H ₇ O ₂) ₂ ; FW: 304.62; yellow xtl.; m.p. 205° dec.		1g 5g

PALLADIUM (Compounds)

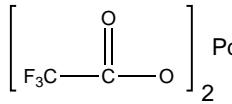
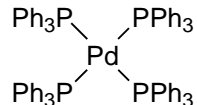
46-1810	Palladium(II) benzoate, 99% (3375-32-4) Pd(C ₇ H ₆ O ₂) ₂ ; FW: 348.65; light-brown powdr.	250mg 1g
46-1836	Palladium(II) bromide, 99% (13444-94-5) PdBr ₂ ; FW: 266.22; black xtl.; d. 5.173 <i>hygroscopic</i>	1g 5g
46-1850	Palladium(II) chloride (99.9%-Pd) (7647-10-1) PdCl ₂ ; FW: 177.31; rust colored xtl.; m.p. 500° dec.; d. 4.0 <i>hygroscopic</i> Note: Palladium Kit component. For detailed technical note visit strem.com .	1g 5g 25g
93-4605 HAZ	Palladium(II) cyanide, 98+% (2035-66-7) Pd(CN) ₂ ; FW: 158.47; yellow powdr.	1g 5g
46-1870	Palladium(II) hexafluoroacetylacetonate, min. 95% (64916-48-9) Pd(CF ₃ COCHCOCF ₃) ₂ ; FW: 520.52; yellow powdr.	250mg 1g 5g
93-4607	Palladium(II) iodide, 99% (7790-38-7) PdI ₂ ; FW: 360.23; black xtl.; m.p. 350° dec.; d. 6.003	1g 5g
96-4650	Palladium Kit See page 488	
93-4608 HAZ	Palladium(II) nitrate hydrate (Pd ~40%) (99.9%-Pd) (10102-05-3) Pd(NO ₃) ₂ ·XH ₂ O; FW: 230.72; brown xtl.; m.p. dec.	1g 5g
46-2110	Palladium(II) oxide (99.9%-Pd) (1314-08-5) PdO; FW: 122.40; black powdr.; m.p. 870°; d. 8.70	1g 5g
93-4609 HAZ	Palladium(II) sulfate dihydrate (13566-03-5) PdSO ₄ ·2H ₂ O; FW: 202.46 (238.50); brown xtl.	1g 5g
46-0280	Palladium(II) trifluoroacetate, min. 97% (42196-31-6) Pd(OCCF ₃) ₂ ; FW: 332.44; brown powdr.; m.p. 210° dec.	250mg 1g 5g
		
46-1785	Palladium(II) trimethylacetate, min. 98% (106224-36-6) Pd[O ₂ CC(CH ₃) ₃] ₂ ; FW: 308.67; orange powdr.	250mg 1g
93-4610	Potassium hexachloropalladate(IV), 99% (16919-73-6) See page 342	
93-4611	Potassium tetrabromopalladate(II), 98% (13826-93-2) See page 344	
46-2126	Potassium tetrachloropalladate(II), 99% (10025-98-6) See page 344	
93-4612	Sodium hexachloropalladate(IV), 98+% (53823-60-2) See page 418	
93-4613	Sodium tetrachloropalladate(II) trihydrate, 99% (13820-53-6) See page 421	
46-2143	Tetraammine palladium(II) tetrachloropalladate(II), 99% (13820-44-5) [Pd(NH ₃) ₄][PdCl ₄]; FW: 422.80; red powdr.	1g 5g
46-2140	Tetraamminepalladium(II) nitrate solution (5.0 wt% as Pd) (13601-08-6) [Pd(NH ₃) ₄](NO ₃) ₂ ; FW: 298.53; pale yellow liq. (store cold)	10g 50g
46-2145	Tetrakis(acetonitrile)palladium(II) tetrafluoroborate, min. 98% (21797-13-7) Pd(CH ₃ CN) ₄ (BF ₄) ₂ ; FW: 444.22; yellow powdr. <i>air sensitive, light sensitive</i>	250mg 1g 5g
46-2150	Tetrakis(triphenylphosphine)palladium(0), 99% (99.9+%-Pd) (14221-01-3) Pd[(C ₆ H ₅) ₃ P] ₄ ; FW: 1155.57; bright yellow powdr. <i>air sensitive, (store cold)</i> Note: Palladium Kit component. For detailed technical note visit strem.com .	1g 5g 25g
		

PALLADIUM (Compounds)

46-7860	Triphenylphosphinepalladium(II) dichloride phosphaadamantane ethyl Silica (Phosphonic PAPd1r) yellow solid Note: Sold in collaboration with PhosphonicS Ltd. for research purposes only.		500mg 2g
Technical Note:			
1. Immobilized palladium heterogeneous catalyst successfully utilized in typical Suzuki and Heck reactions. The catalyst is effective for a wide range of substrates yielding coupled products in high yield. The catalyst can be simply filtered off and reused over several cycles, with no apparent loss in activity. Typical reactions using the homogeneous version of triphenylphosphinepalladium(II) dichloride phosphaadamantane can be found in <i>Org. Lett.</i> 2003 , 5, 6, <i>Tetrahedron Lett.</i> , 2004 , 45, 8319 and <i>J.Org.Chem.</i> , 2004 , 69, 5082.			
Particle size range: 60-200 microns			
Palladium loading: 0.01 to 0.03 mmol/g			
46-3005	Tris[di(4-acetoxybenzylidene)acetone] dipalladium(0) di(4-acetoxybenzylidene)acetone adduct, min. 97% (1196118-15-6) $C_{63}H_{54}O_{15}Pd_2$; FW: 1263.93; dark purple powdr. <i>air sensitive, moisture sensitive, (store cold)</i> Note: U.S. Patent No. 12/259,001 For detailed technical note visit strem.com .		100mg 500mg
46-3000	Tris(dibenzylideneacetone)dipalladium(0) <i>(51364-51-3)</i> $(C_6H_5CH=CHCOCH=CHC_6H_5)_3Pd_2$; FW: 915.70; purple powdr.; m.p. 152-155° <i>air sensitive, moisture sensitive</i> Note: Palladium Kit component. For detailed technical note visit strem.com .		1g 5g 25g
46-3010	Tris(dibenzylideneacetone)dipalladium(0) chloroform adduct (52522-40-4) $(C_6H_5CH=CHCOCH=CHC_6H_5)_3Pd_2 \cdot CHCl_3$; FW: 1035.08; red to brown solid; m.p. 131-135° <i>air sensitive, moisture sensitive</i> Note: Palladium Kit component. For detailed technical note visit strem.com .		500mg 2g 10g
46-3015	Tris(dibenzylideneacetone)dipalladium(0)/tri-t-butylphosphonium tetrafluoroborate admixture (molar Pd/P = 1:1.2) $C_{51}H_{42}O_3Pd_2[(C_4H_9)_3PH]^+BF_4^-$; purple powdr. <i>air sensitive, moisture sensitive</i> For detailed technical note visit strem.com .		1g 5g
46-3020	Tris(dibenzylideneacetone)dipalladium(0)/tri-t-butylphosphonium tetrafluoroborate admixture (molar Pd/P = 1:2) $C_{51}H_{42}O_3Pd_2[(C_4H_9)_3PH]^+BF_4^-$; purple powdr. <i>air sensitive, moisture sensitive</i> For detailed technical note visit strem.com .		1g 5g

PALLADIUM (Compounds)

- 46-2185** Tris[tris(3,5-bis(trifluoromethyl)phenyl)phosphine]palladium(0), 99% (1130784-80-3)
 $C_{72}H_{27}F_{54}P_3Pd$; FW: 2117.24; yellow xtl.
 Note: Material can be stored at room temperature. Not sensitive to air, moisture, or light.
 For detailed technical note visit strem.com.

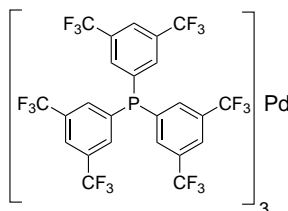

500mg
2g
10g

PHOSPHORUS (Compounds)

- 93-1501** Allyltriphenylphosphonium bromide, 99% (1560-54-9)
 $(CH_2=CHCH_2)(C_6H_5)_3PBr$; FW: 383.26; white xtl.; m.p. 222-225°

25g
100g

- 15-7143** (R)-1-Amino-8-(diphenylphosphino)-1,2,3,4-tetrahydronaphthalene, min. 97% (960128-64-7)
 $C_{22}H_{22}NP$; FW: 331.39; white solid
air sensitive

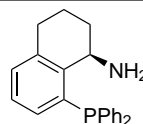

250mg
1g

- 15-7144** (S)-1-Amino-8-(diphenylphosphino)-1,2,3,4-tetrahydronaphthalene, min. 97% (1222630-45-6)
 $C_{22}H_{22}NP$; FW: 331.39; white solid
air sensitive

250mg
1g

- 15-7107** (1R,2R)-2-Amino-1-phenylpropyldiphenylphosphine, min. 97% (799297-44-2)
 $C_{21}H_{22}NP$; FW: 319.38; white solid
air sensitive

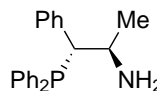

100mg
500mg

- 15-7108** (1S,2S)-2-Amino-1-phenylpropyldiphenylphosphine, min. 97% (341968-71-6)
 $C_{21}H_{22}NP$; FW: 319.38; white solid
air sensitive

100mg
500mg

- 15-7176** (2-Ammonioethyl)di-t-butylphosphonium bis(tetrafluoroborate), min. 97% (1222630-51-4)
 $C_{10}H_{25}B_2F_8NP$; FW: 363.89; white solid
air sensitive

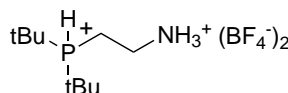

250mg
1g

- Note: Sold under license from Kanata for research purposes only. PCT/CA2009/001412.

- 15-7178** (3-Ammoniopropyl)di-t-butylphosphonium bis(tetrafluoroborate), min. 97%
 $C_{11}H_{27}B_2F_8NP$; FW: 377.92; white solid
air sensitive

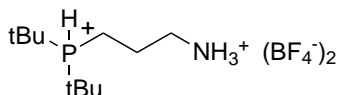

250mg
1g

- Note: Sold under license from Kanata for research purposes only. PCT/CA2009/001412.

- 15-1960** 4-(Anthracen-9-yl)-3-(t-butyl-2,3-dihydrobenzo[d][1,3]oxaphosphole), 98+% rac-AntPhos (1268693-24-8)
 $C_{25}H_{23}O_3P$; FW: 370.42; pale yellow powdr.
air sensitive, (store cold)

NEW

Note: Sold in collaboration with Zejun for research purposes only. Patents ZL201310020371.1, CN 201610056390.

For detailed technical note visit strem.com.

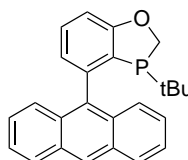

25mg
100mg
500mg

PHOSPHORUS (Compounds)

15-1963 NEW	(R)-4-(Anthracen-9-yl)-3-(t-butyl-2,3-dihydrobenzo[d][1,3]oxaphosphole,98+% (>99% ee) [(R)-AntPhos] (1456816-37-7) C ₂₅ H ₂₃ O ₃ P; FW: 370.42; light-yello xtl. <i>air sensitive, (store cold)</i> Note: Sold in collaboration with Zejun for research purposes only. Patents ZL201310020371.1, CN 201610056390.		25mg 100mg 500mg
Technical Note:	1. See 15-1960 (page 250)		
15-1967 NEW	(S)-4-(Anthracen-9-yl)-3-(t-butyl-2,3-dihydrobenzo[d][1,3]oxaphosphole,99+% (>99% ee) [(S)-AntPhos] (1807740-34-6) C ₂₅ H ₂₃ O ₃ P; FW: 370.42; light yellow xtl. <i>air sensitive, (store cold)</i> Note: Sold in collaboration with Zejun for research purposes only. Patents ZL201310020371.1, CN 201610056390.		25mg 100mg 500mg
Technical Note:	1. See 15-1960 (page 250)		
15-0033	5H-Benzo[b]phosphindole, 99% (244-87-1) C ₁₂ H ₉ P; FW: 184.17; white powdr. <i>air sensitive</i>		250mg 1g
15-0038	Benzyl-di-1-adamantylphosphine, min. 85% [cataCXium® ABN] (395116-70-8) C ₆ H ₅ CH ₂ (C ₁₀ H ₁₅) ₂ P; FW: 392.56; yellow powdr.; m.p. 183° <i>air sensitive</i> Note: Sold in collaboration with Solvias for research purposes only. Patent WO 0210178. Solvias cataCXium® Ligand Kit component. For detailed technical note visit strem.com .		500mg 2g
15-2208	1-Benzyl-3-((1R,2R)-2-[(11bS)-dinaphtho[2,1-d:1',2'-f][1,3,2]dioxaphosphepin-4-ylamino]cyclohexyl)urea, min. 97% (1198080-57-7) C ₃₄ H ₃₂ N ₂ O ₃ P; FW: 561.61; white powdr. <i>moisture sensitive, (store cold)</i> Note: Sold under license from InCaT for research purposes only. WO2004/103559. UREAPhos and METAMORPhos Ligand Kit component. For detailed technical note visit strem.com .		50mg 250mg
15-0040	Benzyl-diphenylphosphine, 99% (7650-91-1) C ₆ H ₅ CH ₂ (C ₆ H ₅) ₂ P; FW: 276.32; white powdr.; m.p. 74-75° <i>air sensitive</i>		1g 5g
15-2210	1-Benzyl-3-[(1S,2S)-2-(di-o-tolylphosphinoamino)cyclohexyl]urea, min. 97% (1858223-87-6) C ₂₈ H ₃₄ N ₂ O ₂ P; FW: 459.56; white powdr. <i>moisture sensitive, (store cold)</i> Note: Sold under license from InCaT for research purposes only. WO2004/103559. UREAPhos and METAMORPhos Ligand Kit component. For detailed technical note visit strem.com .		50mg 250mg
15-5190	(R)-(+)-7'-[4(S)-(Benzyl)oxazol-2-yl]-7-di(3,5-di-t-butylphenyl)phosphino-2,2',3,3'-tetrahydro-1,1'-spirobiindane, min. 97% (Ra,S)-DTB-Bn-SIPHOX C ₅₅ H ₆₆ NOP; FW: 788.09; white solid; m.p. 120-121° <i>moisture sensitive</i> For detailed technical note visit strem.com .		25mg 100mg

PHOSPHORUS (Compounds)

15-5191	(S)-(-)-7'-[4(S)-(Benzyl)oxazol-2-yl]-7-di(3,5-di-t-butylphenyl)phosphino-2,2',3,3'-tetrahydro-1,1'-spirobiindane, min. 97% (Sa,S)-DTB-Bn-SIPHOX (1040274-10-9) C ₅₅ H ₆₆ NOP; FW: 788.09; white solid; m.p. 159-161° <i>moisture sensitive</i> For detailed technical note visit strem.com .	25mg 100mg
15-5186	(R)-(+)-7-[4(S)-(Benzyl)oxazol-2-yl]-7'-diphenylphosphino-2,2',3,3'-tetrahydro-1,1'-spirobiindane, min. 97% (Ra,S)-Ph-Bn-SIPHOX C ₃₉ H ₃₄ NOP; FW: 563.67; white solid; m.p. 100-102° <i>moisture sensitive</i> For detailed technical note visit strem.com .	25mg 100mg
15-5187	(S)-(-)-7-[4(S)-(Benzyl)oxazol-2-yl]-7-diphenylphosphino-2,2',3,3'-tetrahydro-1,1'-spirobiindane, min. 97% (Sa,S)-Ph-Bn-SIPHOX (913829-88-6) C ₃₉ H ₃₄ NOP; FW: 563.67; white solid; m.p. 164-166° <i>moisture sensitive</i> For detailed technical note visit strem.com .	25mg 100mg
15-1613	(R)-(+)-7-[N-(2-Benzylthio)ethylamino]-7'-[bis(3,5-di-t-butylphenyl)phosphino]-2,2',3,3'-tetrahydro-1,1'-spirobiindane, 97+% (>99% ee) [(R)-DTB-SpiroSAP-Bn] (1809609-52-6) C ₅₄ H ₆₈ NPS; FW: 794.16; off-white solid <i>air sensitive</i> For detailed technical note visit strem.com .	25mg 100mg
93-1573 HAZ	Benzyltriphenylphosphonium chloride, 99% (1100-88-5) C ₆ H ₅ CH ₂ (C ₆ H ₅) ₃ PCl; FW: 388.88; white xtl.; m.p. 288°	25g 100g
15-0052	(R)-(-)-1,1'-Binaphthyl-2,2'-diyl hydrogenphosphate, min. 98% (39648-67-4) C ₂₀ H ₁₃ O ₂ P; FW: 348.30; white pwdr. For detailed technical note visit strem.com .	1g 5g
15-0053	(S)(+)-1,1'-Binaphthyl-2,2'-diyl hydrogenphosphate, min. 98% (35193-64-7) C ₂₀ H ₁₃ O ₂ P; FW: 348.30; white pwdr. For detailed technical note visit strem.com .	1g 5g
15-7320	(1R,2R)-N,N-Bis[2-[bis(3,5-dimethylphenyl)phosphino]benzyl]cyclohexane-1,2-diamine, min. 97% (1150113-66-8) C ₅₂ H ₆₀ N ₂ P ₂ ; FW: 774.99; yellow solid <i>air sensitive</i>	100mg 500mg
15-7321	(1S,2S)-N,N-Bis[2-[bis(3,5-dimethylphenyl)phosphino]benzyl]cyclohexane-1,2-diamine, min. 97% C ₅₂ H ₆₀ N ₂ P ₂ ; FW: 774.99; yellow solid <i>air sensitive</i>	100mg 500mg

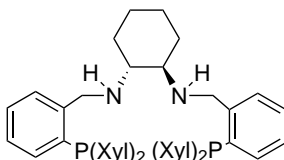
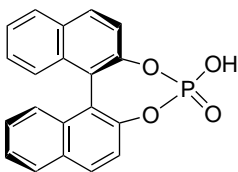
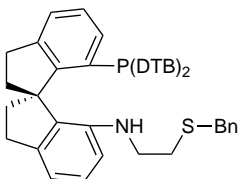
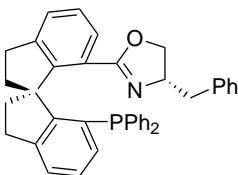

PHOSPHORUS (Compounds)

15-1661	<p>(R)-2,2'-Bis[bis(3,5-dimethylphenyl)phosphino]-4,4',6,6'-tetramethoxy-1,1'-biphenyl, min. 97% (R)-Xyl-Garphos™ (1365531-89-0) C₄₈H₅₂O₈P₂; FW: 754.87; white xtl. <i>air sensitive</i> Note: Sold in collaboration with KCT. Patent US App No. 61/381,493. Garphos™ Ligand Kit component. For detailed technical note visit strem.com.</p>		100mg 500mg
15-1662	<p>(S)-2,2'-Bis[bis(3,5-dimethylphenyl)phosphino]-4,4',6,6'-tetramethoxy-1,1'-biphenyl, min. 97% (S)-Xyl-Garphos™ (1365531-90-3) C₄₈H₅₂O₈P₂; FW: 754.87; white xtl. <i>air sensitive</i> Note: Sold in collaboration with KCT. Patent US App No. 61/381,493. Garphos™ Ligand Kit component. For detailed technical note visit strem.com.</p>		100mg 500mg
15-7125	<p>1,2-Bis[1,3-bis(2,6-di-i-propylphenyl)imidazol-2-ylidene]diphosphine, min. 95% (1080030-13-2) C₅₄H₇₂N₄P₂; FW: 839.12; orange-red xtl. <i>air sensitive</i> Note: Sold under license from the University of Georgia Research Foundation, Inc. for research purposes only. US Patent 8,278,456.</p>		50mg 250mg
<p>Technical Note: 1. A carbene-stabilized diphosphorus. References: 1. <i>Inorg. Chem.</i>, 2011, <i>50</i>, 12326. 2. <i>J. Am. Chem. Soc.</i>, 2008, <i>130</i>, 14970.</p>			
15-1672	<p>(R)-2,2'-Bis[bis(4-methoxy-3,5-di-t-butylphenyl)phosphino]-4,4',6,6'-tetramethoxy-1,1'-biphenyl, min. 97% (R)-DTBM-Garphos™ (1365531-98-1) C₇₆H₁₀₈O₈P₂; FW: 1211.61; white xtl. <i>air sensitive, light sensitive</i> Note: Sold in collaboration with KCT. Patent US App No. 61/381,493. Garphos™ Ligand Kit component. For detailed technical note visit strem.com.</p>		100mg 500mg
15-1673	<p>(S)-2,2'-Bis[bis(4-methoxy-3,5-di-t-butylphenyl)phosphino]-4,4',6,6'-tetramethoxy-1,1'-biphenyl, min. 97% (S)-DTBM-Garphos™ (1365531-99-2) C₇₆H₁₀₈O₈P₂; FW: 1211.61; white xtl. <i>air sensitive, light sensitive</i> Note: Sold in collaboration with KCT. Patent US App No. 61/381,493. Garphos™ Ligand Kit component. For detailed technical note visit strem.com.</p>		100mg 500mg

PHOSPHORUS (Compounds)

15-1666	<p>(R)-2,2'-Bis[bis(4-methoxy-3,5-dimethylphenyl)phosphino]-4,4',6,6'-tetramethoxy-1,1'-biphenyl, min. 97% (R)-DMM-Garphos™ (1365531-93-6) $C_{52}H_{60}O_8P_2$; FW: 874.98; white xtl. <i>air sensitive</i> Note: Sold in collaboration with KCT. Patent US App No. 61/381,493. Garphos™ Ligand Kit component. For detailed technical note visit strem.com.</p>		100mg 500mg
15-1667	<p>(S)-2,2'-Bis[bis(4-methoxy-3,5-dimethylphenyl)phosphino]-4,4',6,6'-tetramethoxy-1,1'-biphenyl, min. 97% (S)-DMM-Garphos™ (1365531-94-7) $C_{52}H_{60}O_8P_2$; FW: 874.98; white xtl. <i>air sensitive</i> Note: Sold in collaboration with KCT. Patent US App No. 61/381,493. Garphos™ Ligand Kit component. For detailed technical note visit strem.com.</p>		100mg 500mg
26-0320	<p>1,1'-Bis[bis(5-methyl-2-furyl) phosphino]ferrocene, 98% HiersoPHOS-3 (756824-22-3) <i>See page 94</i></p>		
15-1366	<p>(11bR)-2,6-Bis[3,5-bis(trifluoromethyl)phenyl]-4-hydroxy-4-oxide-dinaphtho[2,1-d:1',2'-f][1,3,2]dioxaphosphepin, 98%, (99% ee) (791616-62-1) $C_{36}H_{17}F_{12}O_4P$; FW: 772.5; White to light-yellow powdr. Note: Sold in collaboration with Daicel for research purposes only.</p>		100mg
15-1367	<p>(11bS)-2,6-Bis[3,5-bis(trifluoromethyl)phenyl]-4-hydroxy-4-oxide-dinaphtho[2,1-d:1',2'-f][1,3,2]dioxaphosphepin, 98%, (99% ee) (878111-17-2) $C_{36}H_{17}F_{12}O_4P$; FW: 772.5; White to light-yellow powdr. Note: Sold in collaboration with Daicel for research purposes only.</p>		100mg
15-1376	<p>(11bR)-2,6-Bis[3,5-bis(trifluoromethyl)phenyl]-8,9,10,11,12,13,14,15-octahydro-4-hydroxy-4-oxide-dinaphtho[2,1-d:1',2'-f][1,3,2]dioxaphosphepin, 98%, (99% ee) (1011465-24-9) $C_{36}H_{25}F_{12}O_4P$; FW: 780.5; White to light-yellow powdr. Note: Sold in collaboration with Daicel for research purposes only.</p>		100mg
15-1377	<p>(11bS)-2,6-Bis[3,5-bis(trifluoromethyl)phenyl]-8,9,10,11,12,13,14,15-octahydro-4-hydroxy-4-oxide-dinaphtho[2,1-d:1',2'-f][1,3,2]dioxaphosphepin, 98%, (99% ee) $C_{36}H_{25}F_{12}O_4P$; FW: 780.5; White to light-yellow powdr. Note: Sold in collaboration with Daicel for research purposes only.</p>		100mg

PHOSPHORUS (Compounds)

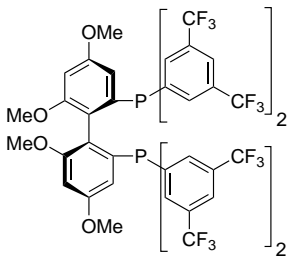
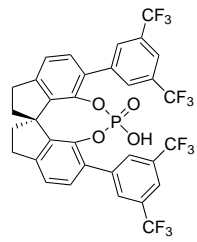
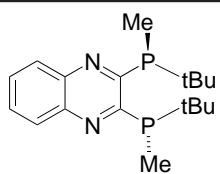
15-1663	<p>(R)-2,2'-Bis[bis(3,5-trifluoromethylphenyl)phosphino]-4,4',6,6'-tetramethoxy)-1,1'-biphenyl, min. 97% (R)-BTFM-Garphos™ (1365531-84-5) C₄₈H₂₈F₂₄O₄P₂; FW: 1186.64; white xtl. <i>air sensitive</i> Note: Sold in collaboration with KCT. Patent US App No. 61/381,493. Garphos™ Ligand Kit component. For detailed technical note visit strem.com.</p>		100mg 500mg
15-1664	<p>(S)-2,2'-Bis[bis(3,5-trifluoromethylphenyl)phosphino]-4,4',6,6'-tetramethoxy)-1,1'-biphenyl, min. 97% (S)-BTFM-Garphos™ (1365531-85-6) C₄₈H₂₈F₂₄O₄P₂; FW: 1186.64; white xtl. <i>air sensitive</i> Note: Sold in collaboration with KCT. Patent US App No. 61/381,493. Garphos™ Ligand Kit component. For detailed technical note visit strem.com.</p>		100mg 500mg
15-0527	<p>(11aR)-3,7-Bis[3,5-bis(trifluoromethyl)phenyl]-10,11,12,13-tetrahydro-5-hydroxy-5-oxide-diindeno[7,1-de:1',7'-fg][1,3,2]dioxaphosphocin, min. 98% (1297613-76-3) C₃₃H₁₉F₁₂O₄P; FW: 738.46; white to light-yellow powdr. Note: Sold in collaboration with Daicel for research purposes only. For detailed technical note visit strem.com.</p>		25mg 100mg
15-0528	<p>(11aS)-3,7-Bis[3,5-bis(trifluoromethyl)phenyl]-10,11,12,13-tetrahydro-5-hydroxy-5-oxide-diindeno[7,1-de:1',7'-fg][1,3,2]dioxaphosphocin, min. 98% (1258327-07-9) C₃₃H₁₉F₁₂O₄P; FW: 738.46; white to light-yellow powdr. Note: Sold in collaboration with Daicel for research purposes only. For detailed technical note visit strem.com.</p>		25mg 100mg
26-0315	<p>1',4-Bis(t-butyl)-1,2-bis(diphenylphosphino)-3'-(di-i-propylphosphino)ferrocene, 98% HiersoPHOS-1 (1313012-94-0) See page 94</p>		
15-0126	<p>(R,R)-(-)-2,3-Bis(t-butylmethylphosphino)quinoxaline, min. 98% (R,R)-QuinoxP* (866081-62-1) C₁₈H₂₈N₂P₂; FW: 334.38; orange powdr.; m.p. 102-103° Note: Sold in collaboration with JCI for research purposes only. US 7,608,709, JP4,500,289. For detailed technical note visit strem.com.</p>		100mg 500mg
15-0127	<p>(S,S)-(+)-2,3-Bis(t-butylmethylphosphino)quinoxaline, min. 98% (S,S)-QuinoxP* (1107608-80-9) C₁₈H₂₈N₂P₂; FW: 334.38; orange powdr.; m.p. 102-103° Note: Sold in collaboration with JCI for research purposes only. US 7,608,709, JP4,500,289. For detailed technical note visit strem.com.</p>		100mg 500mg
26-0326	<p>4,4'-Bis(t-butyl)-1,1',2,2'-tetrakis(diphenylphosphino)ferrocene, 98% HiersoPHOS-5 (403815-19-0) See page 94</p>		
26-0318	<p>1',4-Bis(t-butyl)-1,2,3'-tris(diphenylphosphino)ferrocene, 98% HiersoPHOS-2 (1159850-42-6) See page 94</p>		

PHOSPHORUS (Compounds)

15-0270	Bis(3-carboxyphenyl)(3-trifluoromethylphenyl)phosphine, min. 97% m-Miran2phos (1808959-39-8) $C_{21}H_{14}F_3O_4P$; FW: 418.30; white powdr. Note: Sold under license from UAB for research purposes only. Spanish Patent Application P201231702.		100mg 500mg
15-0268	Bis(4-carboxyphenyl)(4-trifluoromethylphenyl)phosphine, min. 97% p-Miran2phos $C_{21}H_{14}F_3O_4P$; FW: 418.30; white solid Note: Sold under license from UAB for research purposes only. Spanish Patent Application P201231702.		100mg 500mg
15-0075	Bis(2-cyanoethyl)phenylphosphine, min. 97% (15909-92-9) $(NCCH_2CH_2)_2(C_6H_5)P$; FW: 216.22; colorless xtl.; m.p. 72-73°; b.p. 176-178°/0.5 mm <i>air sensitive</i>		1g 5g
15-7312	Bis[2-(di-1-adamantylphosphino)ethyl]amine, min. 97% (1086138-36-4) $C_{44}H_{89}NP_2$; FW: 673.97; white solid <i>air sensitive</i> Note: Sold under license from Kanata for research purposes only. WO 2004096735.		250mg 1g
15-7338	2-[Bis(3,5-di-t-butyl-4-methoxyphenyl)phosphino]benzaldehyde, min. 97% (1202865-21-1) $C_{37}H_{51}O_3P$; FW: 574.77; yellow solid		100mg 500mg
15-5147	(R)-(+)-7-Bis(3,5-di-t-butylphenyl)phosphino-7'-[[4-t-butylpyridine-2-ylmethyl)amino]-2,2',3,3'-tetrahydro-1,1'-spirobiindane, min. 98% (>99% ee) (R)-DTB-SpiroPAP-4-t-Bu (1298133-38-6) $C_{55}H_{71}N_2P$; FW: 791.14; white solid; m.p. 86-88° <i>air sensitive</i> For detailed technical note visit strem.com .		25mg 100mg
15-5158	(R)-(+)-7-Bis(3,5-di-t-butylphenyl)phosphino-7'-[[3-methylpyridine-2-ylmethyl)amino]-2,2',3,3'-tetrahydro-1,1'-spirobiindane, min. 98% (>99% ee) (R)-DTB-SpiroPAP-3-Me (1298133-36-4) $C_{52}H_{65}N_2P$; FW: 749.06; white to off-white solid; m.p. 160-161° <i>air sensitive</i> For detailed technical note visit strem.com .		25mg 100mg

PHOSPHORUS (Compounds)

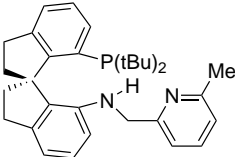
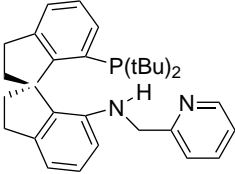
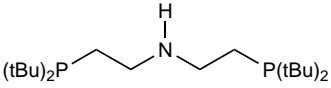
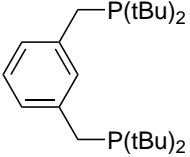
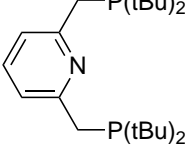
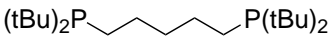
15-5148 NEW	(R)-(+)-7-Bis(3,5-di-t-butylphenyl)phosphino-7'-[[6-methylpyridine-2-ylmethyl]amino]-2,2',3,3'-tetrahydro-1,1'-spirobiindane, min. 98% (>99% ee) (R)-DTB-SpiroPAP-6-Me (1298133-26-2) C ₅₂ H ₆₅ N ₂ P; FW: 749.06; white solid; m.p. 153-155° <i>air sensitive</i> For detailed technical note visit strem.com .		25mg 100mg
15-5159 NEW	(S)-(-)-7-Bis(3,5-di-t-butylphenyl)phosphino-7'-[[3-methylpyridine-2-ylmethyl]amino]-2,2',3,3'-tetrahydro-1,1'-spirobiindane, min. 98% (>99% ee) (S)-DTB-SpiroPAP-3-Me C ₅₂ H ₆₅ N ₂ P; FW: 749.06; white to off-white solid; m.p. 162-164° <i>air sensitive</i>		25mg 100mg
Technical Note: 1. See 15-5158 (page 256)			
15-5166 NEW	(R)-(+)-7-Bis(3,5-di-t-butylphenyl)phosphino-7'-[[pyridine-2-ylmethyl]amino]-2,2',3,3'-tetrahydro-1,1'-spirobiindane, min. 98% (>99% ee) (R)-DTB-SpiroPAP (1298133-21-7) C ₅₁ H ₆₃ N ₂ P; FW: 735.03; white solid; m.p. 172-174° <i>air sensitive</i> For detailed technical note visit strem.com .		25mg 100mg
15-5167 NEW	(S)-(-)-7-Bis(3,5-di-t-butylphenyl)phosphino-7'-[[pyridine-2-ylmethyl]amino]-2,2',3,3'-tetrahydro-1,1'-spirobiindane, min. 98% (>99% ee) (S)-DTB-SpiroPAP (1415636-82-6) C ₅₁ H ₆₃ N ₂ P; FW: 735.03; white solid; m.p. 170-171° <i>air sensitive</i> For detailed technical note visit strem.com .		25mg 100mg
15-7309	Bis[2-(di-t-butylphosphino)ethyl]amine, min. 97% (10wt% in hexanes) (944710-34-3) C ₂₀ H ₄₅ NP ₂ ; FW: 361.53; colorless liq. <i>air sensitive</i> Note: Sold under license from Kanata for research purposes only. WO 2004096735.		5g 25g
26-0150	1,1'-Bis(di-t-butylphosphino)ferrocene, min. 98% DTBPF (84680-95-5) See page 95		
15-0065	1,3-Bis(di-t-butylphosphinomethyl)benzene, 99% (149968-36-5) C ₆ H ₄ [CH ₂ P(C ₄ H ₉) ₂] ₂ ; FW: 394.56; white powdr. <i>air sensitive</i>		250mg 1g
15-0063	2,6-Bis(di-t-butylphosphinomethyl)pyridine, 99% (338800-13-8) C ₅ H ₄ N[CH ₂ P(C ₄ H ₉) ₂] ₂ ; FW: 395.54; white to light-yellow powdr. <i>air sensitive</i>		250mg 1g
15-0061	1,5-Bis(di-t-butylphosphino)pentane, min. 97% (65420-68-0) (C ₄ H ₉) ₂ P(CH ₂) ₅ P(C ₄ H ₉) ₂ ; FW: 360.54; colorless, viscous liq. <i>air sensitive</i> For detailed technical note visit strem.com .		500mg 2g

PHOSPHORUS (Compounds)

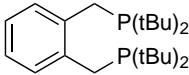
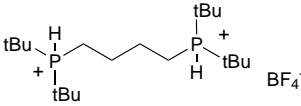
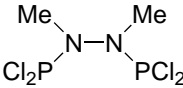
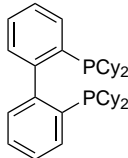
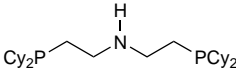
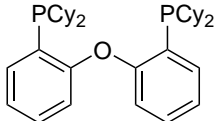
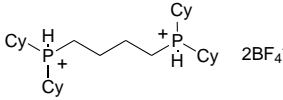
15-0072	α, α'-Bis(di-<i>t</i>-butylphosphino)-<i>o</i>-xylene, min. 97% (121954-50-5) $C_8H_4[CH_2P(C_4H_9)_2]_2$; FW: 394.56; white xtl.; m.p. 59-62° <i>air sensitive</i>		500mg 2g
15-9582	1,4-Bis(di-<i>t</i>-butylphosphonium)butane bis(tetrafluoroborate), min. 97% (C_6H_9) ₂ PH ⁺ CH ₂ CH ₂ CH ₂ CH ₂ PH ⁺ (C ₆ H ₉) ₂ (BF ₄) ₂ ; FW: 522.14; white solid; m.p. 257-259°		1g 5g
15-0069 amp	1,2-Bis(dichlorophosphino)benzene, min. 97% (82495-67-8) $C_6H_4Cl_2P_2$; FW: 279.85; colorless to pale yellow liq. <i>moisture sensitive</i>		500mg 2g
15-0076 amp HAZ	1,2-Bis(dichlorophosphino)-1, 2-dimethylhydrazine, min. 98% (37170-64-2) $Cl_2PN(CH_3)N(CH_3)PCl_2$; FW: 261.84; colorless to slightly cloudy liq. <i>air sensitive, moisture sensitive</i> For detailed technical note visit strem.com .		2g 10g
15-0082 amp HAZ	1,2-Bis(dichlorophosphino)ethane, min. 97% (28240-69-9) $Cl_2PCH_2CH_2PCl_2$; FW: 231.81; colorless to pale yellow liq.; b.p. 70°/1 mm; d. 1.536 <i>air sensitive, moisture sensitive</i>		2g 10g 50g
15-0081 amp HAZ	Bis(dichlorophosphino)methane, min. 90% (28240-68-8) $Cl_2PCH_2PCL_2$; FW: 217.78; colorless liq.; b.p. 101-105°/22mm; d. 1.601 <i>air sensitive, moisture sensitive</i>		2g 10g
15-0116 amp HAZ	Bis(dichlorophosphino)methylamine, min. 97% (17648-16-7) $CH_3N(PCl_2)_2$; FW: 232.80; colorless to pale yellow liq. <i>moisture sensitive</i>		500mg 2g
15-9560	2,2'-Bis(dicyclohexylphosphino)-1,1'-biphenyl, min. 97% (255897-36-0) $C_{36}H_{52}P_2$; FW: 546.75; white to pale yellow powdr.		250mg 1g
15-9585	1,2-Bis(dicyclohexylphosphino)ethane, min. 98% (23743-26-2) (C_6H_{11}) ₂ PCH ₂ CH ₂ P(C_6H_{11}) ₂ ; FW: 422.61; white xtl.; m.p. 96-97° <i>air sensitive</i>		1g 5g
15-7310	Bis[2-(dicyclohexylphosphino)ethyl]amine, min. 97% (550373-32-5) $C_{26}H_{53}NP_2$; FW: 465.67; white solid <i>air sensitive</i> Note: Sold under license from Kanata for research purposes only. WO 2004096735.		250mg 1g
15-9590	Bis(dicyclohexylphosphino)methane, min. 97% (137349-65-6) (C_6H_{11}) ₂ PCH ₂ P(C_6H_{11}) ₂ ; FW: 408.59; white xtl. <i>air sensitive</i>		1g 5g
15-0048	Bis(2-dicyclohexylphosphinophenyl)ether, 98% (434336-16-0) $C_{36}H_{52}OP_2$; FW: 562.75; white powdr.		500mg 2g
15-9562	1,4-Bis(dicyclohexylphosphonium)butane bis(tetrafluoroborate), min. 97% (1389309-54-9) (C_6H_{11}) ₂ PH ⁺ CH ₂ CH ₂ CH ₂ CH ₂ PH ⁺ (C ₆ H ₁₁) ₂ (BF ₄) ₂ ; FW: 626.29; white solid; m.p. 236-238°		1g 5g

PHOSPHORUS (Compounds)

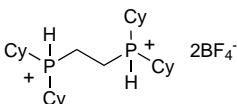
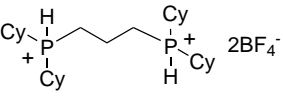
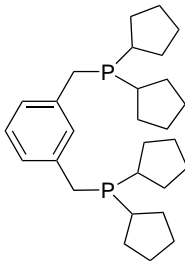
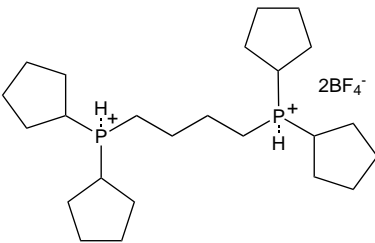
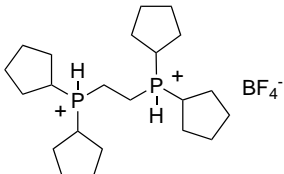
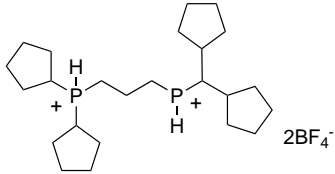
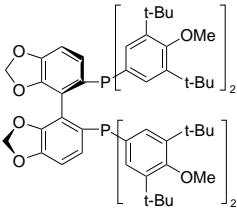
15-9558	1,2-Bis(dicyclohexylphosphonium)ethane bis(tetrafluoroborate), min. 97% (1779389-90-0) C ₂₆ H ₅₀ B ₂ F ₈ P ₂ ; FW: 598.23; white solid; m.p. 236-239°		1g 5g
15-9593	1,3-Bis(dicyclohexylphosphonium)propane bis(tetrafluoroborate), min. 97% (1002345-50-7) [(C ₆ H ₁₁) ₂ PCH ₂ CH ₂ CH ₂ P(C ₆ H ₁₁) ₂] ₂ ·2HBF ₄ ; FW: 612.26; white powder. <i>hygroscopic</i> For detailed technical note visit strem.com .		1g 5g
15-9595	1,3-Bis(dicyclopentylphosphinomethyl)benzene, 99% (255874-48-7) C ₆ H ₄ [CH ₂ P(C ₅ H ₉) ₂] ₂ ; FW: 442.60; white, waxy solid <i>air sensitive</i>		250mg 1g
15-9574	1,4-Bis(dicyclopentylphosphonium)butane bis(tetrafluoroborate), min. 97% (1799401-51-6) (C ₅ H ₉) ₂ PH ⁺ CH ₂ CH ₂ CH ₂ CH ₂ CH ₂ PH ⁺ (C ₅ H ₉) ₂ (BF ₄) ₂ ; FW: 570.18; white solid; m.p. 195-197°		1g 5g
15-9568	1,2-Bis(dicyclopentylphosphonium)ethane bis(tetrafluoroborate), min. 97% (1799401-52-7) (C ₅ H ₉) ₂ PH ⁺ CH ₂ CH ₂ PH ⁺ (C ₅ H ₉) ₂ (BF ₄) ₂ ; FW: 542.13; white solid; m.p. 230-233°		1g 5g
15-9572	1,3-Bis(dicyclopentylphosphonium)propane bis(tetrafluoroborate), min. 97% (1799401-53-8) (C ₅ H ₉) ₂ PH ⁺ CH ₂ CH ₂ CH ₂ PH ⁺ (C ₅ H ₉) ₂ (BF ₄) ₂ ; FW: 556.15; white powder; m.p. 141-143°		1g 5g
15-0066	(R)-(-)-5,5'-Bis[di(3,5-di-t-butyl-4-methoxyphenyl)phosphino]-4,4'-bi-1,3-benzodioxole, min. 98% (R)-(-)-DTBM-SEGPHOS® (566940-03-2) C ₇₄ H ₁₀₀ O ₈ P ₂ ; FW: 1179.53; off-white powder; m.p. 126-128° Note: Manufactured under license of Takasago patent. Takasago SEGPHOS® Ligand Kit component. For detailed technical note visit strem.com .		250mg 1g 5g

PHOSPHORUS (Compounds)

15-0067	(S)(+)-5,5'-Bis[di(3,5-di-t-butyl-4-methoxyphenyl)phosphino]-4,4'-bi-1,3-benzodioxole, min. 98% (S)(+)-DTBM-SEGPHOS® (210169-40-7) C ₇₄ H ₁₀₀ O ₈ P ₂ ; FW: 1179.53; off-white powdr.; m.p. 126-128° Note: Manufactured under license of Takasago patent. Takasago SEGPHOS® Ligand Kit component. For detailed technical note visit strem.com .		250mg 1g 5g
15-0042	(R)(-)-2,2'-Bis[di(3,5-di-t-butyl-4-methoxyphenyl)phosphino]-6,6'-dimethoxy-1,1'-biphenyl, min. 97% (352655-61-9) C ₇₄ H ₁₀₄ O ₆ P ₂ ; FW: 1151.60; white xtl. Note: Sold in collaboration with Solvias for research purposes only. Solvias (R)-MeO BIPHEP Ligand Kit component. For detailed technical note visit strem.com .		100mg 500mg 2g 10g
15-0043	(S)(+)-2,2'-Bis[di(3,5-di-t-butyl-4-methoxyphenyl)phosphino]-6,6'-dimethoxy-1,1'-biphenyl, min. 97% (910134-30-4) C ₇₄ H ₁₀₄ O ₆ P ₂ ; FW: 1151.60; white xtl. Note: Sold in collaboration with Solvias for research purposes only. Solvias (S)-MeO BIPHEP Ligand Kit component.		100mg 500mg 2g 10g
Technical Note: 1. See 15-0042 (page 260)			
15-0044	(R)(+)-2,2'-Bis[di(3,5-di-t-butylphenyl)phosphino]-6,6'-dimethoxy-1,1'-biphenyl, min. 97% (192138-05-9) C ₇₀ H ₉₆ O ₂ P ₂ ; FW: 1031.49; white powdr. Note: Sold in collaboration with Solvias for research purposes only. Solvias (R)-MeO BIPHEP Ligand Kit component. For detailed technical note visit strem.com .		100mg 500mg 2g 10g
15-0045	(S)(-)-2,2'-Bis[di(3,5-di-t-butylphenyl)phosphino]-6,6'-dimethoxy-1,1'-biphenyl, min. 97% (167709-31-1) C ₇₀ H ₉₆ O ₂ P ₂ ; FW: 1031.49; white powdr. Note: Sold in collaboration with Solvias for research purposes only. Solvias (S)-MeO BIPHEP Ligand Kit component.		100mg 500mg 2g 10g
Technical Note: 1. See 15-0044 (page 260)			
15-0185	NEW (R)(+)-2,2'-Bis[di(3,5-dimethoxyphenyl)phosphino]-6,6'-dimethoxy-1,1'-biphenyl, 98% (R)-ECNU-Phos (1448722-98-2) C ₄₆ H ₄₈ O ₁₀ P ₂ ; FW: 822.82; white solid; m.p. 236-237° <i>air sensitive, (store cold)</i> Note: Sold under license from ECNU for research purposes only. Patent CN201310135176.3. For detailed technical note visit strem.com .		25mg 100mg
15-4320	(+)-1,13-Bis[di(3,5-dimethylphenyl)phosphino]-(5aR,8aR,14aR)-5a,6,7,8,8a,9-hexahydro-5H-[1]benzopyrano[3,2-d]xanthene, 97% (R,R,R)-(+)-Xyl-SKP (1429939-35-4) C ₅₂ H ₅₄ O ₂ P ₂ ; FW: 772.93; white solid; m.p. 102-103° <i>air sensitive</i> Note: Sold in collaboration with SIOC for research purposes only. Patents PCT/CN2013/071091, CN202110253896.5. SKP Ligand Kit component. For detailed technical note visit strem.com .		25mg 100mg

PHOSPHORUS (Compounds)

15-4321	(-)-1,13-Bis[di(3,5-dimethylphenyl)phosphino]-(5a <i>S</i> ,8a <i>S</i> ,14a <i>S</i>)-5a,6,7,8,8a,9-hexahydro-5H-[1]benzopyrano[3,2- <i>d</i>]xanthene, 97% (<i>S,S,S</i>)-(-)-Xyl-SKP (1429939-31-0) $C_{52}H_{54}O_2P_2$; FW: 772.93; white solid; m.p. 102-103° <i>air sensitive</i> Note: Sold in collaboration with SIOC for research purposes only. Patents PCT/CN2013/071091, CN202110253896.5. SKP Ligand Kit component. For detailed technical note visit strem.com .		25mg 100mg
15-5172	racemic- <i>trans</i> -1,2-Bis[di(3,5-dimethylphenyl)phosphinomethyl]cyclobutane, min. 95% (1226906-44-0) $C_{38}H_{46}P_2$; FW: 564.72; white solid		250mg 1g
15-5168	(<i>R</i>)-(+)-7,7'-Bis[di(3,5-dimethylphenyl)phosphino]-2,2',3,3'-tetrahydro-1,1'-spirobiindane, min. 97% (<i>R</i>)-Xyl-SDP (917377-75-4) $C_{49}H_{50}P_2$; FW: 700.87; off-white to pale yellow solid <i>air sensitive</i> Note: Spiro Bisphosphine Ligand Kit component. For detailed technical note visit strem.com .		25mg 100mg
15-5169	(<i>S</i>)-(-)-7,7'-Bis[di(3,5-dimethylphenyl)phosphino]-2,2',3,3'-tetrahydro-1,1'-spirobiindane, min. 97% (<i>S</i>)-Xyl-SDP (528521-89-3) $C_{49}H_{50}P_2$; FW: 700.87; off-white to pale yellow solid <i>air sensitive</i> Note: Spiro Bisphosphine Ligand Kit component. For detailed technical note visit strem.com .		25mg 100mg
15-0652	(<i>R</i>)-(-)-2,2'-Bis[di(3,5-di- <i>i</i> -propyl-4-dimethylaminophenyl)phosphino]-6,6'-dimethoxy-1,1'-biphenyl, min. 97% (352655-40-4) $C_{70}H_{100}N_4O_2P_2$; FW: 1091.55; white powdr. (store cold) Note: Sold in collaboration with Solvias for research purposes only. Solvias (<i>R</i>)-MeO BIPHEP Ligand Kit component. For detailed technical note visit strem.com .		100mg 500mg 2g 10g
15-0653	(<i>S</i>)-(+)-2,2'-Bis[di(3,5-di- <i>i</i> -propyl-4-dimethylaminophenyl)phosphino]-6,6'-dimethoxy-1,1'-biphenyl, min. 97% (919338-66-2) $C_{70}H_{100}N_4O_2P_2$; FW: 1091.55; white powdr. (store cold) Note: Sold in collaboration with Solvias for research purposes only. Solvias (<i>S</i>)-MeO BIPHEP Ligand Kit component.		100mg 500mg 2g 10g
Technical Note: 1. See 15-0652 (page 261)			
15-0119	Bis(diethoxyphosphoryl)acetylene, 99% (4851-53-0) $C_{10}H_{20}O_6P_2$; FW: 298.21; yellow liq.; b.p. 181.5-182.5(2.5mm); d. 1.12 <i>moisture sensitive</i>		500mg 2g
15-0084	Bis(diethylamino)chlorophosphine, min. 97% (685-83-6) amp HAZ [(C_2H_5) ₂ N] ₂ PCl; FW: 210.68; colorless to light yellow liq. (may contain trace insolubles); b.p. 124-125°/15 mm; d. 1.002 <i>air sensitive, moisture sensitive</i>		1g 5g
15-0083	1,2-Bis(diethylphosphino)ethane, 98% (6411-21-8) amp HAZ (C_2H_5) ₂ PCH ₂ CH ₂ P(C_2H_5) ₂ ; FW: 206.25; colorless liq.; b.p. 124-126°/10 mm; d. 0.884 (25°) <i>air sensitive</i>		1g 5g

PHOSPHORUS (Compounds)

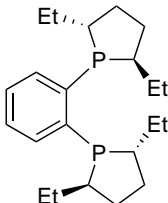
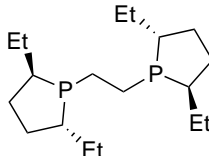
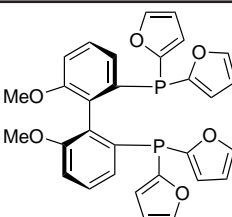
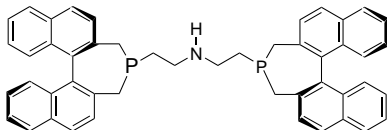
15-0097	(-)-1,2-Bis((2R,5R)-2,5-diethylphospholano)benzene, 98+% (R,R)-Et-DUPHOS (136779-28-7) C ₂₂ H ₃₆ P ₂ ; FW: 362.48; colorless oil; d. 1.01 <i>air sensitive</i> For detailed technical note visit strem.com .		100mg 500mg 2g
15-0098	(+)-1,2-Bis((2S,5S)-2,5-diethylphospholano)benzene, 98+% (S,S)-Et-DUPHOS (136779-28-7) C ₂₂ H ₃₆ P ₂ ; FW: 362.48; colorless oil; d. 1.010 <i>air sensitive</i> For detailed technical note visit strem.com .		100mg 500mg 2g
15-0101	(+)-1,2-Bis((2R,5R)-2,5-diethylphospholano)ethane, 98+% (R,R)-Et-BPE (136705-62-9) (C ₈ H ₁₆)PCH ₂ CH ₂ P(C ₈ H ₁₆); FW: 314.43; colorless to pale-yellow liq.; b.p. 104-106°/0.05mm; d. 0.939 <i>air sensitive</i> For detailed technical note visit strem.com .		100mg 500mg 2g
15-0102	(-)-1,2-Bis((2S,5S)-2,5-diethylphospholano)ethane, 98+% (S,S)-Et-BPE (136779-27-6) (C ₈ H ₁₆)PCH ₂ CH ₂ P(C ₈ H ₁₆); FW: 314.43; colorless to pale-yellow liq.; b.p. 104-106°/0.05mm <i>air sensitive</i>		100mg 500mg 2g
26-1625	1,1'-Bis((2R,5R)-2,5-diethylphospholano)ferrocene, min. 97% (147762-89-8) See page 95		
26-1626	1,1'-Bis((2S,5S)-2,5-diethylphospholano)ferrocene, min. 97% (436863-50-2) See page 95		
26-0201	(-)-1,1'-Bis((2S,4S)-2,4-diethylphosphonato)ferrocene, min. 95% (S,S)-Et-FerroTANE® (290347-66-9) See page 95		
15-0112	(R)-(+)-2,2'-Bis(di-2-furanylphosphino)-6,6'-dimethoxy-1,1'-biphenyl, min. 97% (145214-57-9) C ₃₀ H ₂₄ O ₆ P ₂ ; FW: 542.47; off-white pwdr. (store cold) Note: Sold in collaboration with Solvias for research purposes only. Solvias (R)-MeO BIPHEP Ligand Kit component. For detailed technical note visit strem.com .		100mg 500mg 2g 10g
15-0113	(S)-(-)-2,2'-Bis(di-2-furanylphosphino)-6,6'-dimethoxy-1,1'-biphenyl, min. 97% (145214-59-1) C ₃₀ H ₂₄ O ₆ P ₂ ; FW: 542.47; off-white pwdr. (store cold) Note: Sold in collaboration with Solvias for research purposes only. Solvias (S)-MeO BIPHEP Ligand Kit component.		100mg 500mg 2g 10g
Technical Note: 1. See 15-0112 (page 262)			
15-7301	Bis[2-[(11bR)-3,5-dihydro-4H-dinaphtho[2,1-c:1',2'-e]phosphepin-4-yl]ethyl]amine, min. 97% (851870-89-8) C ₄₈ H ₄₁ NP ₂ ; FW: 693.79; white solid <i>air sensitive</i> Note: Sold under license from Kanata for research purposes only. WO2004096735.		100mg 500mg

PHOSPHORUS (Compounds)

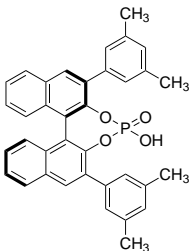
15-0089	1,2-Bis(dimethoxyphosphoryl)benzene, 99% (15104-46-8) C ₆ H ₄ [P(O)(OCH ₃) ₂] ₂ ; FW: 294.18; white xtl.; m.p. 80-82°	5g 25g
26-0240	(S,S)-(-)-2,2'-Bis[(R)-(N,N-dimethylamino)(phenyl)methyl]-1,1'-bis(dicyclohexylphosphino)ferrocene, min. 97% (494227-35-9) See page 96	
26-0248	(S,S)-(-)-2,2'-Bis[(R)-(N,N-dimethylamino)(phenyl)methyl]-1,1'-bis[di(3,5-dimethyl-4-methoxyphenyl)phosphino]ferrocene, min. 97% (494227-37-1) See page 96	
26-0245	(R,R)-(+)-2,2'-Bis[(S)-(N,N-dimethylamino)(phenyl)methyl]-1,1'-bis(di(3,5-dimethylphenyl)phosphino)ferrocene, min. 97% (847997-73-3) See page 96	
26-0246	(S,S)-(-)-2,2'-Bis[(R)-(N,N-dimethylamino)(phenyl)methyl]-1,1'-bis(di(3,5-dimethylphenyl)phosphino)ferrocene, min. 97% (793718-16-8) See page 96	
26-0253	(R,R)-(+)-2,2'-Bis[(S)-(N,N-dimethylamino)(phenyl)methyl]-1,1'-bis(di(2-methylphenyl)phosphino)ferrocene, min. 97% (831226-39-2) See page 96	
26-0252	(S,S)-(-)-2,2'-Bis[(R)-(N,N-dimethylamino)(phenyl)methyl]-1,1'-bis(diphenylphosphino)ferrocene, min. 97% (174467-31-3) See page 96	
26-0244	(S,S)-(-)-2,2'-Bis[(R)-(N,N-dimethylamino)(phenyl)methyl]-1,1'-bis[di(3,5-trifluoromethylphenyl)phosphino]ferrocene, min. 97% (494227-36-0) See page 97	
15-0087	Bis(dimethylamino)phosphoryl chloride, 95+% (1605-65-8) HAZ [(CH ₃) ₂ N] ₂ P(O)Cl; FW: 170.58; colorless liq.; b.p. 85°/0.35 mm; f.p. >230°F; d. 1.17 <i>moisture sensitive</i>	10g 50g
15-0111	Bis(3,5-dimethyl-4-methoxyphenyl)chlorophosphine, min. 98% (136802-85-2) HAZ C ₁₈ H ₂₂ ClO ₂ P; FW: 336.79; colorless, viscous liq. <i>moisture sensitive</i>	500mg 2g
26-1150	(R)-(-)-1-[(S)-2-[Bis(3,5-dimethyl-4-methoxyphenyl)phosphino]ferrocenyl] ethyldicyclohexylphosphine, min. 97% (360048-63-1) See page 97	
26-1130	(R)-(+)-1-[(R)-2-[2'-Bis(3,5-dimethyl-4-methoxyphenyl)phosphinophenyl]ferrocenyl] ethylbis(di-3,5-tri fluoromethylphenyl) phosphine, min. 97% (494227-30-4) See page 97	
15-1368	(11bR)-2,6-Bis(3,5-dimethylphenyl)-4-hydroxy-4-oxide-dinaphtho[2,1-d:1',2'-f][1,3,2]dioxaphosphepin, 98%, (99% ee) (861909-53-7) C ₃₈ H ₂₉ O ₄ P; FW: 556.6; White to light-yellow powdr. Note: Sold in collaboration with Daicel for research purposes only.	100mg
		
15-1369	(11bS)-2,6-Bis(3,5-dimethylphenyl)-4-hydroxy-4-oxide-dinaphtho[2,1-d:1',2'-f][1,3,2]dioxaphosphepin, 98%, (99% ee) (1170736-59-0) C ₃₆ H ₂₉ O ₄ P; FW: 556.6; White to light-yellow powdr. Note: Sold in collaboration with Daicel for research purposes only.	100mg

PHOSPHORUS (Compounds)

15-1373	(11bR)-2,6-Bis(3,5-dimethylphenyl)-8,9,10,11,12,13,14,15-octahydro-4-hydroxy-4-oxide-dinaphtho[2,1-d:1',2'-f][1,3,2]dioxaphosphepin, 98%, (99% ee) (1065214-95-0) C ₃₆ H ₃₇ O ₃ P; FW: 564.7 Note: Sold in collaboration with Daicel for research purposes only.		100mg
15-1374	(11bS)-2,6-Bis(3,5-dimethylphenyl)-8,9,10,11,12,13,14,15-octahydro-4-hydroxy-4-oxide-dinaphtho[2,1-d:1',2'-f][1,3,2]dioxaphosphepin, 98%, (99% ee) C ₃₆ H ₃₇ O ₃ P; FW: 564.7; White to light-yellow powdr. Note: Sold in collaboration with Daicel for research purposes only.		100mg
15-0088 amp HAZ 	Bis(3,5-dimethylphenyl)phosphine, 98% (71360-06-0) [(CH ₃) ₂ C ₆ H ₃] ₂ PH; FW: 242.30; colorless liq. <i>pyrophoric</i>		100mg 500mg
15-6185 amp	Bis(3,5-dimethylphenyl)phosphine, 98% (10wt% in hexanes) (71360-06-0) [(CH ₃) ₂ C ₆ H ₃] ₂ PH; FW: 242.30; colorless liq. <i>air sensitive</i>		1g 5g
15-4330	(+)-1,13-Bis[di(4-methylphenyl)phosphino]-(5aR, 8aR, 14aR)-5a,6,7,8,8a,9-hexahydro-5H-[1]benzopyrano[3,2-d]xanthene, 97% (R,R,R)-(+)-Tol-SKP (1429939-32-1) C ₄₈ H ₄₆ O ₂ P ₂ ; FW: 716.83; white solid; m.p. 90-92° <i>air sensitive</i> Note: Sold in collaboration with SIOC for research purposes only. Patents PCT/CN2013/071091, CN202110253896.5. SKP Ligand Kit component. For detailed technical note visit strem.com .		25mg 100mg
15-4331	(-)-1,13-Bis[di(4-methylphenyl)phosphino]-(5aS, 8aS, 14aS)-5a,6,7,8,8a,9-hexahydro-5H-[1]benzopyrano[3,2-d]xanthene, 97% (S,S,S)-(-)-Tol-SKP (1548897-80-8) C ₄₈ H ₄₆ O ₂ P ₂ ; FW: 716.83; white powdr.; m.p. 90-92° <i>air sensitive</i> Note: Sold in collaboration with SIOC for research purposes only. Patents PCT/CN2013/071091, CN202110253896.5. SKP Ligand Kit component. For detailed technical note visit strem.com .		25mg 100mg
15-7340	2-[Bis(3,5-dimethylphenyl)phosphino]benzaldehyde, min. 97% (669091-00-3) C ₂₃ H ₂₃ OP; FW: 346.40; yellow solid		100mg 500mg
15-5180	(R)-(+)-7,7'-Bis[di(4-methylphenyl)phosphino]-2,2',3,3'-tetrahydro-1,1'-spirobiindane, min. 97% (R)-Tol-SDP (528521-87-1) C ₄₅ H ₄₂ P ₂ ; FW: 644.76; white solid; m.p. 150-152° <i>air sensitive</i> Note: Spiro Bisphosphine Ligand Kit component. For detailed technical note visit strem.com .		25mg 100mg

PHOSPHORUS (Compounds)

15-5181	(S)-(-)-7,7'-Bis[di(4-methylphenyl)phosphino]-2,2',3,3'-tetrahydro-1,1'-spirobiindane, min. 97% (S)-Tol-SDP (817176-80-0) C ₄₆ H ₄₂ P ₂ ; FW: 644.76; white solid; m.p. 150-152° <i>air sensitive</i> Note: Spiro Bisphosphine Ligand Kit component.	25mg 100mg
Technical Note: 1. See 15-5180 (page 264)		
15-0542	NEW (11aR)-3,7-Bis(3,5-dimethylphenyl)-10,11,12,13-tetrahydro-5-hydroxy-5-oxide-diindeno[7,1-de:1',7'-fg][1,3,2]dioxaphosphocin, min. 98% (1297613-75-2) C ₃₃ H ₃₁ O ₂ P; FW: 522.57; white to light-yellow pwdr. Note: Sold in collaboration with Daicel for research purposes only. For detailed technical note visit strem.com .	25mg 100mg
15-0543	NEW (11aS)-3,7-Bis(3,5-dimethylphenyl)-10,11,12,13-tetrahydro-5-hydroxy-5-oxide-diindeno[7,1-de:1',7'-fg][1,3,2]dioxaphosphocin, min. 98% (1412439-82-7) C ₃₃ H ₃₁ O ₂ P; FW: 522.57; white to light-yellow pwdr. Note: Sold in collaboration with Daicel for research purposes only.	25mg 100mg
Technical Note: 1. See 15-0542 (page 265)		
15-0090	1,2-Bis(dimethylphosphino)ethane, 98% DMPE (23936-60-9) (CH ₃) ₂ PCH ₂ CH ₂ P(CH ₃) ₂ ; FW: 150.14; colorless liq.; b.p. 180°; f.p. 2°F; d. 0.90 <i>air sensitive</i>	250mg 1g 5g
15-0093	Bis(dimethylphosphino)methane, min. 98% (64065-08-3) (CH ₃) ₂ PCH ₂ P(CH ₃) ₂ ; FW: 136.12; colorless liq.; b.p. 42°/12 mm; d. 0.86 <i>air sensitive, pyrophoric</i>	1g 5g
15-0096	(-)-1,2-Bis((2R,5R)-2,5-dimethylphospholano)benzene, 98+% (R,R)-Me-DUPHOS (147253-67-6) C ₁₈ H ₂₈ P ₂ ; FW: 306.37; white xtl.; m.p. 82-84° <i>air sensitive</i> For detailed technical note visit strem.com .	100mg 500mg 2g
15-0092	(+)-1,2-Bis((2S,5S)-2,5-dimethylphospholano)benzene, 98+% (S,S)-Me-DUPHOS (136735-95-0) C ₁₈ H ₂₈ P ₂ ; FW: 306.37; white xtl.; m.p. 82-84° <i>air sensitive</i> For detailed technical note visit strem.com .	100mg 500mg 2g
15-0104	(+)-1,2-Bis((2R,5R)-2,5-dimethylphospholano)ethane, 98+% (R,R)-Me-BPE (129648-07-3) (C ₆ H ₁₂)PCH ₂ CH ₂ P(C ₆ H ₁₂); FW: 258.33; colorless to pale-yellow liq.; b.p. 64-67°/0.06mm; d. 0.940 <i>air sensitive</i> For detailed technical note visit strem.com .	100mg 500mg 2g
15-0105	(-)-1,2-Bis((2S,5S)-2,5-dimethylphospholano)ethane, 98+% (S,S)-Me-BPE (136779-26-5) (C ₆ H ₁₂)PCH ₂ CH ₂ P(C ₆ H ₁₂); FW: 258.33; colorless to pale-yellow liq.; b.p. 64-67°/0.06mm; d. 0.938 <i>air sensitive</i>	100mg 500mg 2g

PHOSPHORUS (Compounds)

26-1618	1,1'-Bis((2R,5R)-2,5-dimethylphospholano)ferrocene, min. 97% (540475-45-4) See page 97	
26-1619	1,1'-Bis((2S,5S)-2,5-dimethylphospholano)ferrocene, min. 97% (162412-87-5) See page 97	
15-0099	Bis(4,6-dimethyl-3-sulfonatophenyl) (2,4-dimethylphenyl)phosphine, disodium salt hydrate, min. 95% TXPDS $C_{24}H_{25}Na_2O_6PS_2$; FW: 550.54; white powdr. Note: Water soluble phosphine.	250mg 1g
15-0094	1,2-Bis(dipentafluorophenylphosphino)ethane, 99% (76858-94-1) $(C_6F_5)_2PCH_2CH_2P(C_6F_5)_2$; FW: 758.26; off-white xtl.; m.p. 188-190°	1g 5g
15-0100	Bis(diphenylphosphino)acetylene, 97% (5112-95-8) $(C_6H_5)_2PC\equiv CP(C_6H_5)_2$; FW: 394.39; white xtl.; m.p. 85-87°	1g 5g
15-0110	N,N-Bis(diphenylphosphino)amine, min. 98% (2960-37-4) $(C_6H_5)_2PNHP(C_6H_5)_2$; FW: 385.38; white xtl.; m.p. 143-145°	1g 5g
15-0402	(S)-(-)-2,2'-Bis(N-diphenylphosphinoamino)- 5,5',6,6',7,7',8,8'-octahydro-1,1'-binaphthyl, min. 95% CTH-(S)-BINAM (229177-79-1) $C_{44}H_{42}N_2P_2$; FW: 660.77; white solid Note: Sold in collaboration with Johnson Matthey for research purposes only. US patent US 5919981 and patents arising therefrom. For detailed technical note visit strem.com .	100mg 500mg
15-0130	1,2-Bis(diphenylphosphino)benzene, 98% (13991-08-7) $o-C_6H_4[P(C_6H_5)_2]_2$; FW: 446.47; white xtl.; m.p. 185-187°	1g 5g
15-7325	(1R,2R)-N,N-Bis[2-(diphenylphosphino) benzyl]cyclohexane-1,2-diamine, min. 97% (174758-63-5) $C_{44}H_{44}N_2P_2$; FW: 662.78; yellow solid <i>air sensitive</i>	250mg 1g
15-7326	(1S,2S)-N,N-Bis[2-(diphenylphosphino)benzyl]cyclohexane-1,2-diamine, min. 97% (174677-83-9) $C_{44}H_{44}N_2P_2$; FW: 662.78; yellow solid <i>air sensitive</i>	250mg 1g
15-0136	(R)-(+)-5,5'-Bis(diphenylphosphino)-4,4'-bi-1,3-benzo- dioxole, min. 98% (R)-(+)-SEGPHOS® (244261-66-3) $C_{38}H_{26}O_4P_2$; FW: 610.57; off-white powdr.; m.p. 168-172° Note: Manufactured under license of Takasago patent. Takasago SEGPHOS® Ligand Kit component. For detailed technical note visit strem.com .	250mg 1g 5g
15-0137	(S)-(-)-5,5'-Bis(diphenylphosphino)-4,4'-bi-1,3-benzodioxole, min. 98% (S)-(-)- SEGPHOS® (210169-54-3) $C_{38}H_{26}O_4P_2$; FW: 610.57; off-white powdr.; m.p. 168-172° Note: Manufactured under license of Takasago patent. Takasago SEGPHOS® Ligand Kit component. For detailed technical note visit strem.com .	250mg 1g 5g

PHOSPHORUS (Compounds)

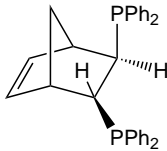
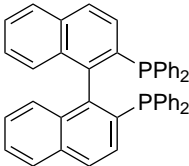
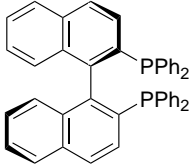
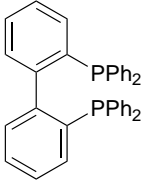
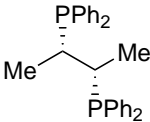
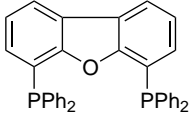
15-0140	(2R,3R)-(-)-2,3-Bis(diphenylphosphino)-bicyclo[2.2.1]hept-5-ene, min. 95% (R,R)-NORPHOS (71042-55-2) C ₃₁ H ₂₈ P ₂ ; FW: 462.51; white xtl.; m.p. 116-119° <i>air sensitive</i> For detailed technical note visit strem.com .		250mg 1g
15-0141	(2S,3S)-(+)-2,3-Bis(diphenylphosphino)-bicyclo[2.2.1]hept-5-ene, min. 95% (S,S)-NORPHOS (71042-54-1) C ₃₁ H ₂₈ P ₂ ; FW: 462.51; white xtl.; m.p. 112-115° <i>air sensitive</i>		250mg 1g
15-0433	racemic-2,2'-Bis(diphenylphosphino)-1,1'-binaphthyl, 98% rac-BINAP (98327-87-8) C ₄₄ H ₃₂ P ₂ ; FW: 622.70; white to light-yellow xtl. Note: Phosphine Ligand Kit component. For detailed technical note visit strem.com .		1g 5g 25g 100g
15-0150	(R)-(+)-2,2'-Bis(diphenylphosphino)-1,1'-binaphthyl, 98% (R)-(+)-BINAP (76189-55-4) C ₄₄ H ₃₂ P ₂ ; FW: 622.70; white to off-white powdr.; m.p. 240.5-242° Note: Manufactured under license of Takasago patent. Takasago BINAP Ligand Kit component. For detailed technical note visit strem.com .		250mg 1g 5g
15-0151	(S)-(-)-2,2'-Bis(diphenylphosphino)-1,1'-binaphthyl, 98% (S)-(-)-BINAP (76189-56-5) C ₄₄ H ₃₂ P ₂ ; FW: 622.70; white to off-white powdr.; m.p. 241-242° Note: Manufactured under license of Takasago patent. Takasago BINAP Ligand Kit component. For detailed technical note visit strem.com .		250mg 1g 5g
15-0145	2,2'-Bis(diphenylphosphino)-1,1'- biphenyl, 98% BIPHEP (84783-64-2) C ₃₆ H ₂₈ P ₂ ; FW: 522.57; white xtl.; m.p. 210-214° For detailed technical note visit strem.com .		250mg 1g 5g
15-0160	(2S,3S)-(-)-Bis(diphenylphosphino)butane (S,S)-CHIRAPHOS (64896-28-2) (C ₆ H ₅) ₂ PCH(CH ₃)CH(CH ₃)P(C ₆ H ₅) ₂ ; FW: 426.48; white xtl.; m.p. 108-109° <i>air sensitive</i> For detailed technical note visit strem.com .		250mg 1g 5g
15-0170	1,4-Bis(diphenylphosphino)butane, 98% DPPB (7688-25-7) (C ₆ H ₅) ₂ PCH ₂ CH ₂ CH ₂ CH ₂ P(C ₆ H ₅) ₂ ; FW: 426.48; white xtl.; m.p. 132-134°		2g 10g 50g
15-0183	4,6-Bis(diphenylphosphino) dibenzofuran, 98% DBFphos (133850-81-4) C ₃₆ H ₂₆ OP ₂ ; FW: 536.54; white powdr.		100mg 500mg 2g

PHOSPHORUS (Compounds)

15-0176	(S)-(+)-1,13-Bis(diphenylphosphino)-7,8-dihydro-6H-dibenzo[f,h][1,5]dioxinin, 95% (S)-C ₃ -TUNEPHOS (486429-99-6) C ₃₀ H ₃₂ O ₂ P ₂ ; FW: 594.62; white powdr. <i>air sensitive</i> Note: Sold in collaboration with Chiral Quest for research purposes only. US Patent No. 6,521,769; additional patents pending. Chiral Quest Catalyst and Ligand Toolbox Kit component.	100mg 500mg
15-0175	R-(-)-1,13-Bis(diphenylphosphino)-7,8-dihydro-6H-dibenzo[f,h][1,5]dioxinin, 97% (R)-C ₃ -TUNEPHOS (301847-89-2) C ₃₀ H ₃₂ O ₂ P ₂ ; FW: 594.62; white powdr. <i>air sensitive</i> Note: Sold in collaboration with Chiral Quest for research purposes only. US Patent No. 6,521,769; additional patents pending. Chiral Quest Catalyst and Ligand Toolbox Kit component. For detailed technical note visit strem.com .	100mg 500mg
15-0178	(R)-(+)-2,2'-Bis(diphenylphosphino)-6,6'-dimethoxy-1,1'-biphenyl, min. 97% (R)-MeO-BIPHEP (133545-16-1) C ₃₀ H ₃₂ O ₂ P ₂ ; FW: 582.53; off-white xtl. Note: Sold in collaboration with Solvias for research purposes only. Solvias (R)-MeO BIPHEP Ligand Kit component. For detailed technical note visit strem.com .	100mg 500mg 2g 10g
15-0179	(S)-(-)-2,2'-Bis(diphenylphosphino)-6,6'-dimethoxy-1,1'-biphenyl, min. 97% (S)-MeO-BIPHEP (133545-17-2) C ₃₀ H ₃₂ O ₂ P ₂ ; FW: 582.53; white xtl. Note: Sold in collaboration with Solvias for research purposes only. Solvias (S)-MeO BIPHEP Ligand Kit component. For detailed technical note visit strem.com .	100mg 500mg 2g 10g
15-0200	1,2-Bis(diphenylphosphino)ethane, 99% DIPHOS (1663-45-2) (C ₆ H ₅) ₂ PCH ₂ CH ₂ P(C ₆ H ₅) ₂ ; FW: 398.43; white powdr.; m.p. 143-145°	5g 25g 100g
15-0205	1,2-Bis(diphenylphosphino)ethane monooxide, min. 97% (984-43-0) (C ₆ H ₅) ₂ PCH ₂ CH ₂ P(O)(C ₆ H ₅) ₂ ; FW: 414.42; white powdr.	1g 5g
15-7306	Bis[(2-diphenylphosphino)ethyl]ammonium chloride, min. 97% (66534-97-2) C ₂₈ H ₃₀ ClNP ₂ ; FW: 477.95; white solid <i>air sensitive</i> Note: Sold under license from Kanata for research purposes only. WO2004096735.	500mg 2g
15-0250	cis-1,2-Bis(diphenylphosphino)ethylene, min. 98% (983-80-2) cis-(C ₆ H ₅) ₂ PCH=CHP(C ₆ H ₅) ₂ ; FW: 396.41; white xtl.; m.p. 125-126°	1g 5g
15-0383 NEW	[Bis(2-diphenylphosphino)ethyl]ether, min. 98% (50595-38-5) C ₂₈ H ₂₈ OP ₂ ; FW: 442.47; pale yellow oil <i>air sensitive</i>	1g 5g 25g
15-0350	Bis(2-diphenylphosphinoethyl)phenylphosphine, 97% TRIPHOS (23582-02-7) (C ₆ H ₅) ₂ PCH ₂ CH ₂ P(C ₆ H ₅)CH ₂ CH ₂ P(C ₆ H ₅) ₂ ; FW: 534.56; white powdr.; m.p. 130-134°	1g 5g
26-0270	1,1'-Bis(diphenylphosphino)ferrocene, 99% DPPF (12150-46-8) See page 97	

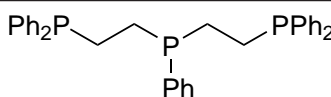
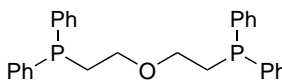
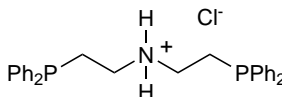
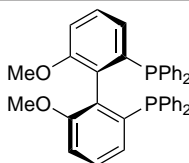
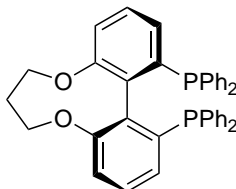

PHOSPHORUS (Compounds)

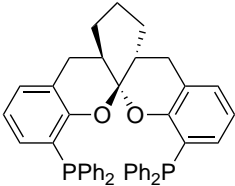
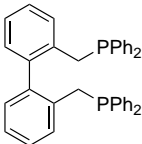
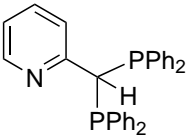
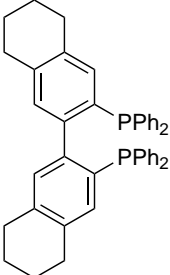
15-4310	(+)-1,13-Bis(diphenyl)phosphino-(5aR,8aR,14aR)-5a,6,7,8,8a,9-hexahydro-5H-[1]benzopyrano [3,2-d]xanthene, 97% (R,R,R)-(+)-Ph-SKP (1360823-43-3) C ₄₄ H ₃₈ O ₂ P ₂ ; FW: 660.72; white solid; m.p. 101-103° <i>air sensitive</i> Note: Sold in collaboration with SIOC for research purposes only. Patents PCT/CN2013/071091, CN202110253896.5. SKP Ligand Kit component. For detailed technical note visit strem.com .		25mg 100mg
15-4311	(-)-1,13-Bis(diphenyl)phosphino-(5aS,8aS,14aS)-5a,6,7,8,8a,9-hexahydro-5H-[1]benzopyrano [3,2-d]xanthene, 97% (S,S,S)-(-)-Ph-SKP (1439556-82-7) C ₄₄ H ₃₈ O ₂ P ₂ ; FW: 660.72; white solid; m.p. 101-103° <i>air sensitive</i> Note: Sold in collaboration with SIOC for research purposes only. Patents PCT/CN2013/071091, CN202110253896.5. SKP Ligand Kit component. For detailed technical note visit strem.com .		25mg 100mg
15-0400	Bis(diphenylphosphino)methane, 97% (2071-20-7) (C ₆ H ₅) ₂ PCH ₂ P(C ₆ H ₅) ₂ ; FW: 384.40; white xtl.; m.p. 116-119°		1g 5g 25g
15-2988	2,2'-Bis(diphenylphosphinomethyl)-1,1'-biphenyl, 99% BISBI (111982-81-1) C ₃₈ H ₃₂ P ₂ ; FW: 550.61; white solid; m.p. 84-86° <i>air sensitive</i> For detailed technical note visit strem.com .		250mg 1g
15-2970	(4R,5R)-(-)-4,5-Bis(diphenylphosphinomethyl)-2,2-dimethyl-1,3-dioxolane, 99.5% (R,R)-DIOP (32305-98-9) C ₃₁ H ₃₂ O ₂ P ₂ ; FW: 498.55; white powdr.; m.p. 87-91° <i>air sensitive</i>		250mg 1g
15-2960	(4S,5S)-(+)-4,5-Bis(diphenylphosphinomethyl)-2,2-dimethyl-1,3-dioxolane, 99.5% (S,S)-DIOP (37002-48-5) C ₃₁ H ₃₂ O ₂ P ₂ ; FW: 498.55; white powdr.; m.p. 87-91° <i>air sensitive</i>		250mg 1g
26-0290	1,1'-Bis(1-diphenylphosphino-1-methylethyl)ferrocene ethanol adduct, 97% HiersoPHOS-6 (Sylphos) (109313-83-9) See page 97		
15-1779	2-[Bis(diphenylphosphino)methyl]pyridine, 98% (60398-55-2) C ₃₀ H ₂₅ NP ₂ ; FW: 461.47; white powdr.		100mg 500mg
15-0502	3,3'-Bis(diphenylphosphino)-5,5',6,6',7,7',8,8'-octahydro [2,2']binaphthalene chloroform adduct, 99% (1067889-87-5) C ₄₄ H ₄₀ P ₂ ·0.5CHCl ₃ ; FW: 630.74 (690.43); white to pale yellow powdr. Note: Sold under license from NCL for research purposes only. Patent Pending GB 0719134.9 and its international derivatives.		100mg 500mg

Technical Note:

1. Ligand used in the platinum-catalyzed asymmetric carbonyl-ene reaction.

References:

1. *Org. Lett.*, **2007**, 9, 4925.

PHOSPHORUS (Compounds)

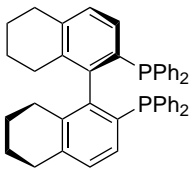
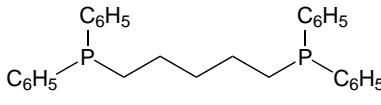
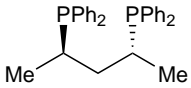
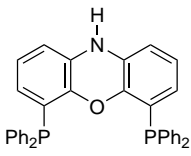
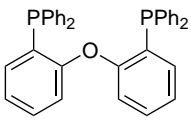
15-2972	(R)(+)-2,2'-Bis(diphenylphosphino)-5,5',6,6',7,7',8,8'-octahydro-1,1'-binaphthyl (R)-(+)-H ₈ -BINAP (139139-86-9) C ₄₄ H ₄₀ P ₂ ; FW: 630.74; off-white powdr.; m.p. 207-208° Note: Manufactured under license of Takasago patent. For detailed technical note visit strem.com .		50mg 250mg
15-2973	(S)(-)-2,2'-Bis(diphenylphosphino)-5,5',6,6',7,7',8,8'-octahydro-1,1'-binaphthyl (S)(-)-H ₈ -BINAP (139139-93-8) C ₄₄ H ₄₀ P ₂ ; FW: 630.74; off-white powdr.; m.p. 207-208° Note: Manufactured under license of Takasago patent. For detailed technical note visit strem.com .		50mg 250mg
15-0420	1,8-Bis(diphenylphosphino)octane, 99% (41625-30-3) C ₃₂ H ₃₆ P ₂ ; FW: 482.58; white powdr.		1g 5g
15-0425	(R)(-)-4,12-Bis(diphenylphosphino)-[2.2]-paracyclophane, min. 95% (R)-PHANEPHOS (364732-88-7) C ₄₀ H ₃₄ P ₂ ; FW: 576.65; white solid; m.p. 222-225° Note: Sold in collaboration with Johnson Matthey for research purposes only. US patent Application No 5874629 and patents arising therefrom. For detailed technical note visit strem.com .		100mg 500mg
15-0426	(S)(+)-4,12-Bis(diphenylphosphino)-[2.2]-paracyclophane, min. 95% (S)-PHANEPHOS (192463-40-4) C ₄₀ H ₃₄ P ₂ ; FW: 576.65; white solid; m.p. 222-225° Note: Sold in collaboration with Johnson Matthey for research purposes only. US patent Application No 5874629 and patents arising therefrom. For detailed technical note visit strem.com .		100mg 500mg
15-0430	1,5-Bis(diphenylphosphino)pentane, min. 98% (27721-02-4) (C ₆ H ₅) ₂ P(CH ₂) ₅ P(C ₆ H ₅) ₂ ; FW: 440.51; white to off-white solid; m.p. 46-49°		1g 5g
15-0432	(2R,4R)(+)-2,4-Bis(diphenylphosphino)pentane, 99% (R,R)-BDPP (96183-46-9) (C ₆ H ₅) ₂ PCH(CH ₃)CH ₂ CH(CH ₃)P(C ₆ H ₅) ₂ ; FW: 440.49; white xtl.; m.p. 78° <i>air sensitive</i>		500mg 2g
15-0431	(2S,4S)(-)-2,4-Bis(diphenylphosphino)pentane, 99% (S,S)-BDPP (77876-39-2) (C ₆ H ₅) ₂ PCH(CH ₃)CH ₂ CH(CH ₃)P(C ₆ H ₅) ₂ ; FW: 440.49; white xtl.; m.p. 81° <i>air sensitive</i>		250mg 1g 5g
15-0437	4,6-Bis(diphenylphosphino) phenoxazine, min. 98% NIXANTPHOS (261733-18-0) C ₃₆ H ₂₇ NOP ₂ ; FW: 551.55; white to off-white powdr. For detailed technical note visit strem.com .		500mg 2g
15-0380	Bis(2-diphenylphosphinophenyl)ether, 98% DPEphos (166330-10-5) (C ₆ H ₅) ₂ PC ₆ H ₄ OC ₆ H ₄ P(C ₆ H ₅) ₂ ; FW: 538.56; off-white powdr.; m.p. 181-184° Note: Phosphine Ligand Kit component. For detailed technical note visit strem.com .		5g 25g 100g
15-0450	1,3-Bis(diphenylphosphino)propane, 98% DPPP (6737-42-4) (C ₆ H ₅) ₂ PCH ₂ CH ₂ CH ₂ P(C ₆ H ₅) ₂ ; FW: 412.45; white xtl.; m.p. 60-63°		10g 50g
15-0440	R-(+)-1,2-Bis(diphenylphosphino)propane, 99% (R)-PROPHOS (67884-32-6) (C ₆ H ₅) ₂ PCH(CH ₃)CH ₂ P(C ₆ H ₅) ₂ ; FW: 412.45; white xtl.; m.p. 69-71° (sealed tube) <i>air sensitive</i>		250mg 1g
15-0449	1,3-Bis(diphenylphosphino)propane monooxide, min. 97% (85685-99-0) (C ₆ H ₅) ₂ PCH ₂ CH ₂ CH ₂ P(O)(C ₆ H ₅) ₂ ; FW: 428.44; white powdr.		1g 5g

PHOSPHORUS (Compounds)

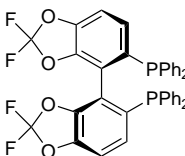
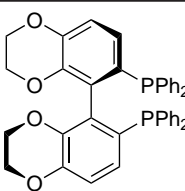
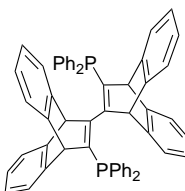
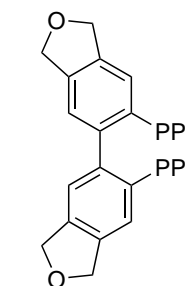
15-0486	<p>R(-)-5,5'-Bis(diphenylphosphino)-2,2,2',2'-tetrafluoro-4,4'-bi-1,3-benzodioxole, dichloromethane adduct, min. 97% (R)-DIFLUORPHOS™ (503538-69-0) $C_{38}H_{24}F_4O_4P_2 \cdot XCH_2Cl_2$; FW: 682.54; white powdr. <i>air sensitive</i></p> <p>Note: Sold under license from SYNKEM for research purposes only-not for drug use. Patent application WO 03/029259. US Patent No. 6.878.665 B2. For directions of use and safety see SDS available at www.strem.com. Optical purity: 99.5+%</p> <p>For detailed technical note visit strem.com.</p>		100mg 500mg
15-0487	<p>S(+)-5,5'-Bis(diphenylphosphino)-2,2,2',2'-tetrafluoro-4,4'-bi-1,3-benzodioxole, dichloromethane adduct, min. 97% (S)-DIFLUORPHOS™ (503538-70-3) $C_{38}H_{24}F_4O_4P_2 \cdot XCH_2Cl_2$; FW: 682.54; white powdr. <i>air sensitive</i></p> <p>Note: Sold under license from SYNKEM for research purposes only-not for drug use. Patent application WO 03/029259. US Patent No. 6.878.665 B2. For directions of use and safety see MSDS sheet available at www.strem.com. Optical purity: 99.5+%</p> <p>For detailed technical note visit strem.com.</p>		100mg 500mg
15-0490	<p>R(+)-6,6'-Bis(diphenylphosphino)-2,2',3,3'-tetrahydro-5,5'-bi-1,4-benzodioxin, min. 94% (R)-SYNPHOS™ (445467-61-8) $C_{40}H_{32}O_4P_2$; FW: 638.63; white powdr.</p> <p>Note: Sold under license from SYNKEM for research purposes only - not for drug use. Patent application WO 03/029259. US Patent No. 6.878.665 B2. For directions of use and safety see MSDS sheet available at www.strem.com</p> <p>For detailed technical note visit strem.com.</p>		100mg 500mg
15-0491	<p>S(-)-6,6'-Bis(diphenylphosphino)-2,2',3,3'-tetrahydro-5,5'-bi-1,4-benzodioxin, min. 97% (S)-SYNPHOS™ (503538-68-9) $C_{40}H_{32}O_4P_2$; FW: 638.63; white powdr.</p> <p>Note: Sold under license from SYNKEM for research purposes only - not for drug use. Patent application WO 03/029259. US Patent No. 6.878.665 B2. For directions of use and safety see MSDS sheet available at www.strem.com</p> <p>For detailed technical note visit strem.com.</p>		100mg 500mg
15-0442	<p>12,12'-Bis(diphenylphosphino)-9,9',10,10'-tetrahydro-11,11'-bi-9,10-ethenoanthracene, min. 98% CATPHOS (1020670-88-5) $C_{58}H_{40}P_2$; FW: 774.86; white xtl.</p> <p>For detailed technical note visit strem.com.</p>		250mg 1g
15-0504	<p>6,6'-Bis(diphenylphosphino)-1,1',3,3'-tetrahydro[5,5']biisobenzofuran, 99% (959864-38-1) $C_{40}H_{32}O_2P_2$; FW: 606.63; white to off-white powdr.</p> <p>Note: Sold under license from NCL for research purposes only. Patent Pending GB 0719134.9 and its international derivatives.</p> <p>For detailed technical note visit strem.com.</p>		100mg 500mg

PHOSPHORUS (Compounds)

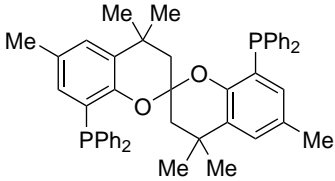
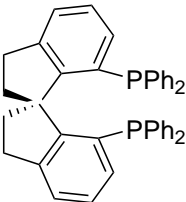
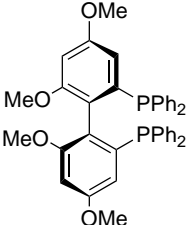
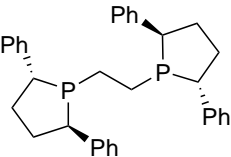
15-5165	racemic-8,8'-Bis(diphenylphosphino)-3,3',4,4'-tetrahydro-4,4',4',6,6'-hexamethyl-2,2'-spirobi[2H-1-benzopyran], min. 95% SPANphos (556797-94-5) C ₄₇ H ₄₆ O ₂ P ₂ ; FW: 704.81; white powder. For detailed technical note visit strem.com.		100mg 500mg
15-5174	(R)-(+)-7,7'-Bis(diphenylphosphino)-2,2',3,3'-tetrahydro-1,1'-spirobiindane, min. 97% (R)-SDP (917377-74-3) C ₄₁ H ₃₄ P ₂ ; FW: 588.66; white solid; m.p. 200-202° <i>air sensitive</i> Note: Spiro Bisphosphine Ligand Kit component. For detailed technical note visit strem.com.		25mg 100mg
15-5175	(S)-(-)-7,7'-Bis(diphenylphosphino)-2,2',3,3'-tetrahydro-1,1'-spirobiindane, min. 97% (S)-SDP (528521-86-0) C ₄₁ H ₃₄ P ₂ ; FW: 588.66; white solid; m.p. 206-208° <i>air sensitive</i> Note: Spiro Bisphosphine Ligand Kit component.		25mg 100mg
Technical Note: 1. See 15-5174 (page 272)			
15-1653	(R)-2,2'-Bis(diphenylphosphino)-4,4',6,6'-tetramethoxy-1,1'-biphenyl, min. 97% (R)-Ph-Garphos™ (1365531-75-4) C ₄₀ H ₃₆ O ₄ P ₂ ; FW: 642.66; white xtl. <i>air sensitive</i> Note: Sold in collaboration with KCT. Patent US App No. 61/381,493. Garphos™ Ligand Kit component. For detailed technical note visit strem.com.		100mg 500mg
15-1654	(S)-2,2'-Bis(diphenylphosphino)-4,4',6,6'-tetramethoxy-1,1'-biphenyl, min. 97% (S)-Ph-Garphos™ (1365531-76-5) C ₄₀ H ₃₆ O ₄ P ₂ ; FW: 642.66; white xtl. <i>air sensitive</i> Note: Sold in collaboration with KCT. Patent US App No. 61/381,493. Garphos™ Ligand Kit component.		100mg 500mg
15-0473	(-)-1,2-Bis((2R,5R)-2,5-diphenylphospholano)ethane, min. 95% (R,R)-Ph-BPE (528565-79-9) (C ₁₆ H ₁₆)PCH ₂ CH ₂ P(C ₁₆ H ₁₆); FW: 506.60; white solid; m.p. 144° <i>air sensitive</i> For detailed technical note visit strem.com.		100mg 500mg 2g
15-0474	(+)-1,2-Bis((2S,5S)-2,5-diphenylphospholano)ethane, min. 98% (S,S)-Ph-BPE (824395-67-7) (C ₁₆ H ₁₆)PCH ₂ CH ₂ P(C ₁₆ H ₁₆); FW: 506.60; white solid; m.p. 144° <i>air sensitive</i>		100mg 500mg 2g
15-0448	Bis(di-i-propylamino)chlorophosphine, min. 97% (56183-63-2) HAZ [(C ₃ H ₇) ₂ N] ₂ PCl; FW: 266.80; white to off-white powder. <i>air sensitive, moisture sensitive</i>		5g 25g
15-0650	1,4-Bis(di-i-propylphosphino)butane, min. 98% (80499-19-0) amp [(C ₃ H ₇) ₂ PCH ₂ CH ₂ CH ₂ CH ₂ P(C ₃ H ₇) ₂]; FW: 290.41; colorless to pale yellow liq. HAZ <i>air sensitive</i>		100mg 500mg

PHOSPHORUS (Compounds)

15-0654	(R)(+)-2,2'-Bis(di-i-propylphosphino)-6,6'-dimethoxy-1,1'-biphenyl, min. 97% (150971-45-2) C ₂₆ H ₄₀ O ₂ P ₂ ; FW: 446.56; white powdr. Note: Sold in collaboration with Solvias for research purposes only. Solvias (R)-MeO BIPHEP Ligand Kit component. For detailed technical note visit strem.com .		100mg 500mg 2g 10g
15-0655	(S)(-)-2,2'-Bis(di-i-propylphosphino)-6,6'-dimethoxy-1,1'-biphenyl, min. 97% (150971-43-0) C ₂₆ H ₄₀ O ₂ P ₂ ; FW: 446.56; white powdr. Note: Sold in collaboration with Solvias for research purposes only. Solvias (S)-MeO BIPHEP Ligand Kit component. For detailed technical note visit strem.com .		100mg 500mg 2g 10g
15-0610 amp HAZ	1,2-Bis(di-i-propylphosphino)ethane, 98% (87532-69-2) C ₁₄ H ₃₂ P ₂ ; FW: 262.35; colorless to pale yellow liq. <i>air sensitive</i>		100mg 500mg
15-7304 HAZ	Bis[[2-di-i-propylphosphino)ethyl]amine, min. 97% (10 wt% in tetrahydrofuran) (131890-26-1) C ₁₆ H ₃₇ NP ₂ ; FW: 305.42; pale yellow to colorless liq. <i>air sensitive</i> Note: Sold under license from Kanata for research purposes only. WO2004096735. For detailed technical note visit strem.com .		5g 20g
26-0275	1,1'-Bis(di-i-propylphosphino)ferrocene, min. 98% DiPPF (97239-80-0) See page 98		
15-0415	4,5-Bis-(di-i-propylphosphinomethyl)acridine, 98+% (1101230-28-7) C ₂₇ H ₃₉ NP ₂ ; FW: 439.55; yellow xtl. <i>air sensitive</i> Note: Patents: US provisional 61/087,708, PCT/IL2009/000778. For detailed technical note visit strem.com .		50mg 250mg
15-0670 NEW	Bis[2-(di-i-propylphosphino)-4-methylphenyl]amine, min. 98% (666856-94-6) C ₂₆ H ₄₁ NP ₂ ; FW: 429.56; white powdr. <i>air sensitive</i> For detailed technical note visit strem.com .		100mg 500mg
15-0680 HAZ	1,3-Bis(di-i-propylphosphino)propane, min. 98% (dipp) (91159-11-4) (C ₃ H ₇) ₂ PCH ₂ CH ₂ CH ₂ P(C ₃ H ₇) ₂ ; FW: 276.38; colorless to pale yellow liq. <i>air sensitive</i> For detailed technical note visit strem.com .		100mg 500mg 2g
15-0410	(+)-1,2-Bis((2R,5R)-2,5-di-i-propylphospholano)benzene, 98+% (R,R)-i-Pr-DUPHOS (136705-65-2) C ₂₆ H ₄₄ P ₂ ; FW: 418.58; white xtl.; m.p. 40° <i>air sensitive</i> For detailed technical note visit strem.com .		100mg 500mg 2g
15-0411	(-)-1,2-Bis((2S,5S)-2,5-di-i-propylphospholano)benzene, 98+% (S,S)-i-Pr-DUPHOS (147253-69-8) C ₂₆ H ₄₄ P ₂ ; FW: 418.58; white xtl.; m.p. 40° <i>air sensitive</i> For detailed technical note visit strem.com .		100mg 500mg 2g

PHOSPHORUS (Compounds)

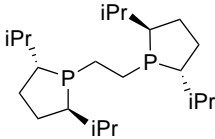
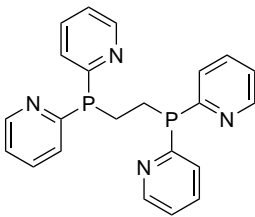
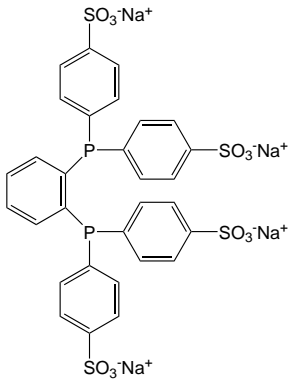
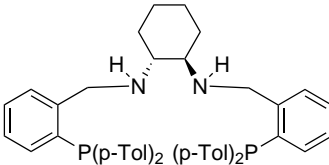
15-7357 amp	1,2-Bis((2R,5R)-2,5-di-i-propylphospholano)ethane, 96% (136705-63-0) $C_{22}H_{44}P_2$; FW: 370.53; white solid <i>air sensitive</i> Note: Sold under license from Kanata for research purposes only.		100mg 500mg
15-7358	1,2-Bis((2S,5S)-2,5-di-i-propylphospholano)ethane, min. 97% (528854-34-4) $C_{22}H_{44}P_2$; FW: 370.53; white solid <i>air sensitive</i> Note: Sold under license from Kanata for research purposes only.		100mg 500mg
26-1610	1,1'-Bis((2R,5R)-2,5-di-i-propylphospholano)ferrocene, min. 97% (849950-54-5) See page 98		
26-1611	1,1'-Bis((2S,5S)-2,5-di-i-propylphospholano)ferrocene, min. 97% (540475-73-8) See page 98		
15-0683	1,2-Bis(di-2-pyridylphosphino)ethane, min. 98% (106308-26-3) $C_{22}H_{20}N_4P_2$; FW: 402.37; white powd.		100mg 500mg
15-0155	1,2-Bis(di-4-sulfonatophenylphosphino)benzene tetrasodium salt DMSO adduct $C_8H_4[P(C_6H_4SO_3^-)]_2 \cdot 4Na^+(CH_3SOCH_3)$; FW: 854.65; off-white powd.		1g 5g
15-7328	(1R,2R)-N,N-Bis[2-(di-p-tolylphosphino)benzyl]cyclohexane-1,2-diamine, min. 97% (1150113-65-7) $C_{48}H_{52}N_2P_2$; FW: 718.89; yellow solid <i>air sensitive</i>		250mg 1g
15-7329	(1S,2S)-N,N-Bis[2-(di-p-tolylphosphino)benzyl]cyclohexane-1,2-diamine, min. 97% (1224727-08-5) $C_{48}H_{52}N_2P_2$; FW: 718.89; yellow solid <i>air sensitive</i>		250mg 1g

PHOSPHORUS (Compounds)

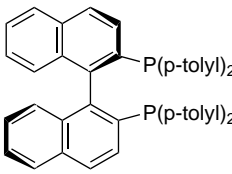
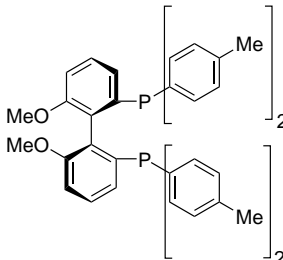
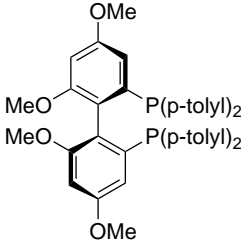
15-0152	(R)-(+)-2,2'-Bis(di-p-tolylphosphino)-1,1'-binaphthyl, 98% (R)-(+)-TolBINAP (99646-28-3) C ₄₈ H ₄₀ P ₂ ; FW: 678.79; white powdr.; m.p. 255-257° Note: Manufactured under license of Takasago patent. Takasago BINAP Ligand Kit component. For detailed technical note visit strem.com .		250mg 1g 5g
15-0153	(S)-(-)-2,2'-Bis(di-p-tolylphosphino)-1,1'-binaphthyl, 98% (S)-(-)-TolBINAP (100165-88-6) C ₄₈ H ₄₀ P ₂ ; FW: 678.79; white powdr.; m.p. 255-257° Note: Manufactured under license of Takasago patent. Takasago BINAP Ligand Kit component. For detailed technical note visit strem.com .		250mg 1g 5g
15-0156	(R)-(+)-2,2'-Bis(di-p-tolylphosphino)-6,6'-dimethoxy-1,1'-biphenyl, min. 97% (133545-24-1) C ₄₂ H ₄₀ O ₂ P ₂ ; FW: 638.73; white powdr. Note: Sold in collaboration with Solvias for research purposes only. Solvias (R)-MeO BIPHEP Ligand Kit component. For detailed technical note visit strem.com .		100mg 500mg 2g 10g
15-0157	(S)-(-)-2,2'-Bis(di-p-tolylphosphino)-6,6'-dimethoxy-1,1'-biphenyl, min. 97% (133545-25-2) C ₄₂ H ₄₀ O ₂ P ₂ ; FW: 638.73; white powdr. Note: Sold in collaboration with Solvias for research purposes only. Solvias (S)-MeO BIPHEP Ligand Kit component. For detailed technical note visit strem.com .		100mg 500mg 2g 10g
15-1657	(R)-2,2'-Bis(di-p-tolylphosphino)-4,4',6,6'-tetramethoxy-1,1'-biphenyl, min. 97% (R)-Tol-Garphos™ (1365531-81-2) C ₄₄ H ₄₄ O ₄ P ₂ ; FW: 698.77; white xtl. <i>air sensitive</i> Note: Sold in collaboration with KCT. Patent US App No. 61/381,493. Garphos™ Ligand Kit component.		100mg 500mg
15-1658	(S)-2,2'-Bis(di-p-tolylphosphino)-4,4',6,6'-tetramethoxy-1,1'-biphenyl, min. 97% (S)-Tol-Garphos™ (1365531-82-3) C ₄₄ H ₄₄ O ₄ P ₂ ; FW: 698.77; white xtl. <i>air sensitive</i> Note: Sold in collaboration with KCT. Patent US App No. 61/381,493. Garphos™ Ligand Kit component. For detailed technical note visit strem.com .		100mg 500mg
15-0114 HAZ	Bis(3,5-di(trifluoromethyl)phenyl)chlorophosphine, min. 98% (142421-57-6) C ₁₆ H ₆ ClF ₁₂ P; FW: 492.63; colorless liq.; m.p. 25-29° <i>moisture sensitive</i>		500mg 2g
26-0960	(R)-(-)-1-((S)-2-[Bis(3,5-di-trifluoromethylphenyl)phosphino]ferrocenyl)ethylidicyclohexylphosphine, min. 97% (292638-88-1) See page 98		
26-0965	(R)-(-)-1-((S)-2-[Bis(3,5-di-trifluoromethylphenyl)phosphino]ferrocenyl)ethylidicyclohexylphosphine, min. 97% (166172-63-0) See page 98		

PHOSPHORUS (Compounds)

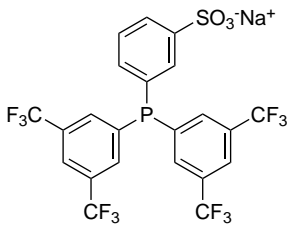
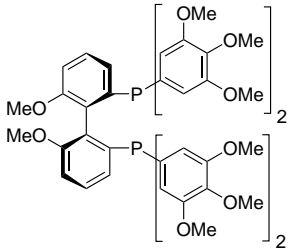
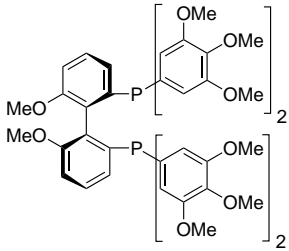
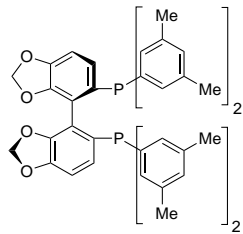
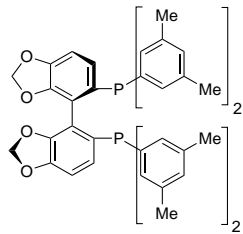
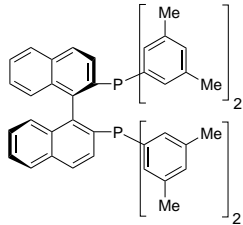
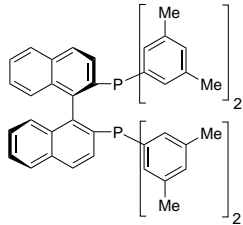
15-0572	<p>Bis(3,5-di-trifluoromethylphenyl)(3-sulfonatophenyl)phosphine, sodium salt, min. 97% DAN2PHOS (1289463-91-7) $C_{22}H_{10}F_{12}NaO_3PS$; FW: 636.32; white solid Note: Sold under license from UAB for research purposes only. PCT/EP2010/06553.</p>		100mg 500mg
15-0158	<p>(R)(+)-2,2'-Bis[di(3,4,5-trimethoxyphenyl)phosphino]-6,6'-dimethoxy-1,1'-biphenyl, min. 97% (256390-47-3) $C_{50}H_{56}O_{14}P_2$; FW: 942.94; off-white powder. <i>air sensitive, (store cold)</i> Note: Sold in collaboration with Solvias for research purposes only. Solvias (R)-MeO BIPHEP Ligand Kit component. For detailed technical note visit strem.com.</p>		100mg 500mg 2g 10g
15-0159	<p>(S)(-)-2,2'-Bis[di(3,4,5-trimethoxyphenyl)phosphino]-6,6'-dimethoxy-1,1'-biphenyl, min. 97% (256235-61-7) $C_{50}H_{56}O_{14}P_2$; FW: 942.94; off-white powder. <i>air sensitive, (store cold)</i> Note: Sold in collaboration with Solvias for research purposes only. Solvias (S)-MeO BIPHEP Ligand Kit component. For detailed technical note visit strem.com.</p>		100mg 500mg 2g 10g
15-0478	<p>(R)(+)-5,5'-Bis[di(3,5-xylyl)phosphino]-4,4'-bi-1,3-benzodioxole, min. 98% (R)(+)-DM-SEGPHOS® (850253-53-1) $C_{46}H_{44}O_4P_2$; FW: 722.79; off white to pale yellow powder.; m.p. 256-261° Note: Manufactured under license of Takasago patent. Takasago SEGPHOS® Ligand Kit component. For detailed technical note visit strem.com.</p>		250mg 1g 5g
15-0479	<p>(S)(-)-5,5'-Bis[di(3,5-xylyl)phosphino]-4,4'-bi-1,3-benzodioxole, min. 98% (S)(-)-DM-SEGPHOS® (210169-57-6) $C_{46}H_{44}O_4P_2$; FW: 722.79; off-white to pale yellow powder.; m.p. 256-261° Note: Manufactured under license of Takasago patent. Takasago SEGPHOS® Ligand Kit component.</p>		250mg 1g 5g
15-0476	<p>(R)(+)-2,2'-Bis[di(3,5-xylyl)phosphino]-1,1'-binaphthyl, 98% (R)(+)-XylBINAP (137219-86-4) $C_{52}H_{48}P_2$; FW: 734.90; white to pale yellow xtl.; m.p. 203-206° Note: Manufactured under license of Takasago patent. Takasago BINAP Ligand Kit component. For detailed technical note visit strem.com.</p>		250mg 1g 5g
15-0477	<p>(S)(-)-2,2'-Bis[di(3,5-xylyl)phosphino]-1,1'-binaphthyl, 98% (S)(-)-XylBINAP (135139-00-3) $C_{52}H_{48}P_2$; FW: 734.90; white to pale yellow xtl.; m.p. 203-206° Note: Manufactured under license of Takasago patent. Takasago BINAP Ligand Kit component.</p>		250mg 1g 5g

Technical Note:

- See 15-0476 (page 276)

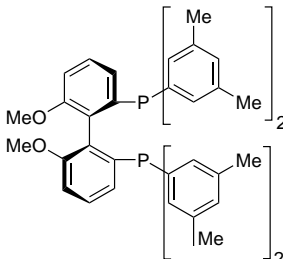
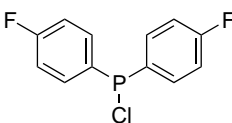
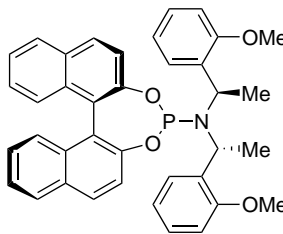

PHOSPHORUS (Compounds)

15-0488	(R)(+)-2,2'-Bis[di(3,5-xylyl)phosphino]-6,6'-dimethoxy-1,1'-biphenyl, min. 97% (394248-45-4) $C_{46}H_{48}O_2P_2$; FW: 694.84; white powdr. (store cold) Note: Sold in collaboration with Solvias for research purposes only. Solvias (R)-MeO BIPHEP Ligand Kit component. For detailed technical note visit strem.com .		100mg 500mg 2g 10g
15-0489	(S)(-)-2,2'-Bis[di(3,5-xylyl)phosphino]-6,6'-dimethoxy-1,1'-biphenyl, min. 97% (362634-22-8) $C_{46}H_{48}O_2P_2$; FW: 694.84; white powdr. (store cold) Note: Sold in collaboration with Solvias for research purposes only. Solvias (S)-MeO BIPHEP Ligand Kit component.		100mg 500mg 2g 10g
Technical Note: 1. See 15-0488 (page 277)			
15-0730	(R)(-)-4,12-Bis(di(3,5-xylyl)phosphino)-[2.2]-paracyclophane, min. 97% CTH-(R)-3,5-xylyl-PHANEPHOS (325168-89-6) $C_{48}H_{50}P_2$; FW: 688.86; white powdr. Note: Sold in collaboration with Johnson Matthey for research purposes only. US patent Application No 5874629 and patents arising therefrom. For detailed technical note visit strem.com .		100mg 500mg
15-0731	(S)(+)-4,12-Bis(di(3,5-xylyl)phosphino)-[2.2]-paracyclophane, min. 97% CTH-(S)-3,5-xylyl-PHANEPHOS (325168-88-5) $C_{48}H_{50}P_2$; FW: 688.86; white powdr. Note: Sold in collaboration with Johnson Matthey for research purposes only. US patent Application No 5874629 and patents arising therefrom. For detailed technical note visit strem.com .		100mg 500mg
26-1261	1,1'-Bis{1-[(R)-ferrocenyl-2-(S)-ethyl-1-(diethylamino) phenyl]- (R)-phosphino} ferrocene, min. 97% Trifer (899811-43-9) See page 98		
26-1260	1,1'-Bis{1-[(R)-ferrocenyl-2-(R)-ethyl-1-(dimethylamino) phenyl]- (S)-phosphino} ferrocene, min. 97% Trifer (900505-82-0) See page 98		
15-7318 HAZ	Bis(4-fluorophenyl) chlorophosphine, min. 98% (23039-97-6) $(FC_6H_4)_2ClP$; FW: 256.62; pale yellow liq. <i>moisture sensitive</i>		250mg 1g
15-0522	(11bR)-N,N-Bis[(R)(-)-1-(2-methoxyphenyl)ethyl]dinaphtho[2,1-d:1',2'-f][1,3,2]dioxaphosphepin-4-amine, min. 98% (736158-72-8) $C_{38}H_{34}NO_4P$; FW: 599.65; white powdr. <i>moisture sensitive</i> For detailed technical note visit strem.com .		100mg 500mg
15-0523	(11bS)-N,N-Bis[(S)(+)-1-(2-methoxyphenyl)ethyl]dinaphtho[2,1-d:1',2'-f][1,3,2]dioxaphosphepin-4-amine, min. 98% (776316-48-4) $C_{38}H_{34}NO_4P$; FW: 599.65; white powdr. <i>moisture sensitive</i> For detailed technical note visit strem.com .		100mg 500mg

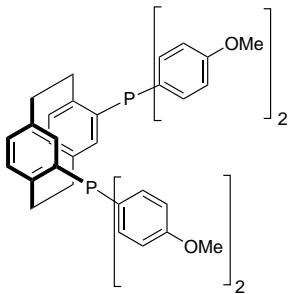
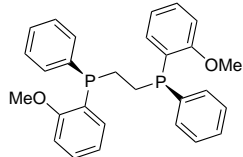
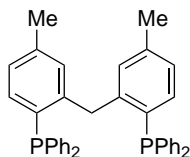
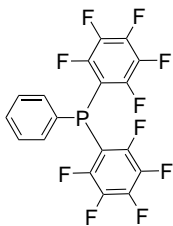
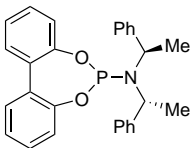
PHOSPHORUS (Compounds)

15-0710	(R)-4,12-Bis(4-methoxyphenyl)-[2.2]-paracyclophane R-An-Phanephos (364732-86-5) C ₄₄ H ₄₂ O ₄ P; FW: 696.75; white pwdr. Note: Sold in collaboration with JM for research purposes only. For detailed technical note visit strem.com .		100mg 500mg
15-0711	(S)-4,12-Bis(4-methoxyphenyl)-[2.2]-paracyclophane S-An-Phanephos C ₄₄ H ₄₂ O ₄ P; FW: 696.75; white pwdr. Note: Sold in collaboration with JM for research purposes only.		100mg 500mg
Technical Note: 1. See 15-0710 (page 278)			
15-0466	Bis(2-methoxyphenyl)phenylphosphine, min. 98% (36802-41-2) (C ₆ H ₄ OCH ₃) ₂ P(C ₆ H ₅); FW: 322.34; white xtl.; m.p. 163-164°		1g 5g 25g
15-0481	(R,R)-(-)-1,2-Bis[(2-methoxyphenyl)(phenyl)phosphino]ethane, 98% (-)-DIPAMP (55739-58-7) (C ₆ H ₄ OCH ₃)(C ₆ H ₅)PCH ₂ CH ₂ P(C ₆ H ₄ OCH ₃)(C ₆ H ₅); FW: 458.47; white xtl.; m.p. 102-103° For detailed technical note visit strem.com .		250mg 1g
15-0482	(S,S)-(+)-1,2-Bis[(2-methoxyphenyl)(phenyl)phosphino]ethane, 98% (+)-DI-PAMP (97858-62-3) (C ₆ H ₄ OCH ₃)(C ₆ H ₅)PCH ₂ CH ₂ P(C ₆ H ₄ OCH ₃)(C ₆ H ₅); FW: 458.47; white xtl.; m.p. 102-103° For detailed technical note visit strem.com .		250mg 1g
15-0358	NEW Bis[2-(4-methyldiphenylphosphino)phenyl]methane, 90% C ₃₉ H ₃₄ P ₂ ; FW: 564.64; white pwdr. For detailed technical note visit strem.com .		100mg 500mg 2g
15-0115	Bis(1-naphthyl)chlorophosphine, min. 97% (36042-99-6) C ₂₀ H ₁₄ ClP; FW: 320.75; white to pale yellow xtl. <i>moisture sensitive</i>		500mg 2g
15-0374	NEW Bis(pentafluorophenyl)phenylphosphine, 97% (5074-71-5) C ₁₈ H ₅ F ₁₀ P; FW: 442.20; white pwdr.; m.p. 59-61°; b.p. 105°C/0.3mm; f.p. >110°C <i>air sensitive</i>		250mg 1g
15-0518	N,N-Bis[(1R)-(+)-phenylethyl]dibenzo[d,f][1,3,2]dioxaphosphepin-6-amine (500103-26-4) C ₂₆ H ₂₆ NO ₂ P; FW: 439.49; white pwdr. <i>moisture sensitive</i> For detailed technical note visit strem.com .		100mg 500mg

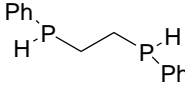
PHOSPHORUS (Compounds)

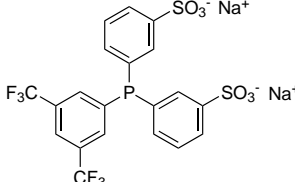
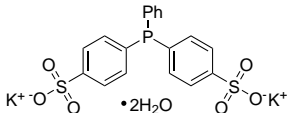
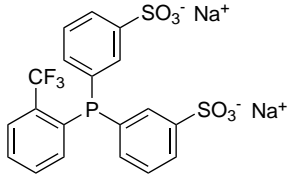
15-0519	N,N-Bis[(1S)-(-)-phenylethyl]dibenzo[d,f][1,3,2]dioxaphosphepin-6-amine (376355-58-7) $C_{26}H_{26}NO_2P$; FW: 439.49; white powd. <i>moisture sensitive</i> For detailed technical note visit strem.com .		100mg 500mg
15-0405 amp HAZ 	1,2-Bis(phenylphosphino)ethane, min. 90% (18899-64-4) (C_6H_5) ₂ HPCH ₂ CH ₂ PH(C_6H_5); FW: 246.22; colorless to yellow liq. <i>pyrophoric</i>		500mg 2g
15-0409 HAZ	1,2-Bis(phenylphosphino)ethane, min. 95% (10wt% in hexanes) (18899-64-4) (C_6H_5) ₂ HPCH ₂ CH ₂ PH(C_6H_5); FW: 246.22; colorless liq. <i>air sensitive</i>		5g 20g
15-0456 amp HAZ	1,3-Bis(phenylphosphino)propane, 90-95% (28240-66-6) $C_6H_5P(H)CH_2CH_2CH_2(H)PC_6H_5$; FW: 260.26; colorless liq.; b.p. 160-165°/1 mm <i>air sensitive</i>		1g 5g
15-0461 amp HAZ 	1,2-Bis(phosphino)benzene, 98+% (80510-04-9) $C_6H_4(PH_2)_2$; FW: 142.08; colorless liq.; b.p. 53-55°/0.25mm; d. 1.101 <i>pyrophoric</i>		1g 5g
15-0462 HAZ	1,2-Bis(phosphino)benzene, 98+% (10 wt% in hexanes) (80510-04-9) $C_6H_4(PH_2)_2$; FW: 142.08; colorless liq. <i>air sensitive</i>		10g 50g
15-0459 amp HAZ 	1,2-Bis(phosphino)ethane, 99% (5518-62-7) $H_2PCH_2CH_2PH_2$; FW: 92.02; colorless liq.; b.p. 109-110° <i>pyrophoric</i>		250mg 1g
15-0570	Bis(3-sulfonatophenyl)(3,5-difluoromethylphenyl)phosphine, disodium salt monohydrate, min. 97% DANPHOS (water soluble) (1289463-82-6) $C_{20}H_{13}F_6Na_2O_6PS_2 \cdot H_2O$; FW: 604.39 (622.41); white powd. Note: Water soluble phosphine. Sold under license from UAB for research purposes only. PCT/EP2010/065531.		100mg 500mg
15-0638 NEW	Bis(p-sulfonatophenyl)phenylphosphine dihydrate dipotassium salt, 97% (308103-66-4) $C_{18}H_{13}K_2O_6PS_2$; FW: 498.60(534.63); white powd.; m.p. 98-102° <i>air sensitive</i>		100mg 500mg
15-0463	Bis(p-sulfonatophenyl)phenylphosphine dihydrate dipotassium salt, min. 97% (151888-20-9) $C_6H_5P(C_6H_4SO_3K)_2 \cdot 2H_2O$; FW: 498.58 (534.62); white powd. For detailed technical note visit strem.com .		500mg 2g 10g
15-0577	Bis(3-sulfonatophenyl)(2-trifluoromethylphenyl)phosphine, disodium dihydrate, min. 97% o-DANPHOS (1289463-84-8) $C_{18}H_{12}F_3Na_2O_6PS_2 \cdot 2H_2O$; FW: 534.38 (570.41); white powd. Note: Water soluble phosphine. Sold under license from UAB for research purposes only. PCT/EP2010/065531.		100mg 500mg

PHOSPHORUS (Compounds)

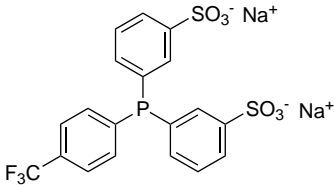
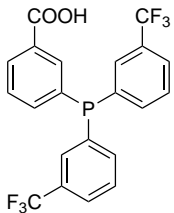
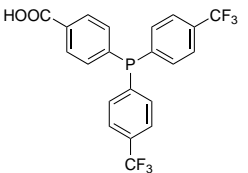
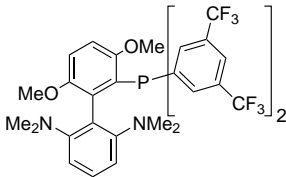
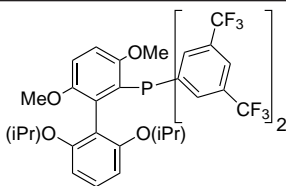
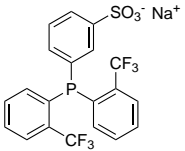
15-0575	Bis(3-sulfonatophenyl)(4-trifluoromethylphenyl)phosphine disodium dihydrate, min. 97% p-DANPHOS (1289463-79-1) $C_{15}H_{12}F_3Na_2O_5PS_2 \cdot 2H_2O$; FW: 534.38 (570.41); white powdr. Note: Water soluble phosphine. Sold under license from UAB for research purposes only. PCT/EP2010/065531.		100mg 500mg
26-0650	(R)-(-)-1-[(S)-2-[Bis(4-trifluoromethylphenyl) phosphino]ferrocenyl] ethyl-di-t-butylphosphine, min. 97% (246231-79-8) See page 99		
15-0265	Bis(3-trifluoromethylphenyl)(3-carboxyphenyl) phosphine, min. 97% m-Miranphos (1808959-38-7) $C_{21}H_{13}F_6O_2P$; FW: 442.29; white solid Note: Sold under license from UAB for research purposes only. Spanish Patent Application P201231702.		100mg 500mg
15-0260	Bis(4-trifluoromethylphenyl)(4-carboxyphenyl) phosphine, min. 97% p-Miranphos (1808959-36-5) $C_{21}H_{13}F_6O_2P$; FW: 442.29; white powdr. Note: Sold under license from UAB for research purposes only. Spanish Patent Application P201231702.		100mg 500mg
15-3015	2-[Bis(3,5-trifluoromethylphenylphosphino)-3,6-dimethoxy]-2',6'-dimethylamino-1,1'-biphenyl, 98% (1810068-30-4) $C_{34}H_{29}F_{12}N_2O_2P$; FW: 756.56; white to off-white powdr. Note: Patents: US 6,395,916, US 6,307,087 For detailed technical note visit strem.com .		100mg 500mg 2g
15-3020	2-[Bis(3,5-trifluoromethylphenylphosphino)-3,6-dimethoxy]-2',6'-di-i-propoxy-1,1'-biphenyl, 98% (1810068-31-5) $C_{36}H_{31}F_{12}O_4P$; FW: 786.58; white to off-white powdr. Note: Patents: US 6,395,916, US 6,307,087 For detailed technical note visit strem.com .		250mg 1g 5g
15-0579	Bis(2-trifluoromethylphenyl)(3-sulfonatophenyl) phosphine, sodium salt, min. 97% o-DAN2PHOS (1289463-93-9) $C_{20}H_{12}F_6NaO_3PS$; FW: 500.33; white powdr. Note: Sold under license from UAB for research purposes only. PCT/EP2010/065531.		100mg 500mg

PHOSPHORUS (Compounds)

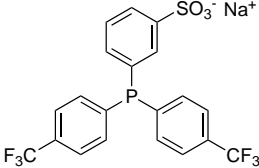
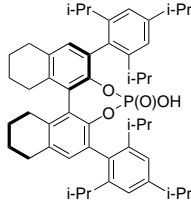
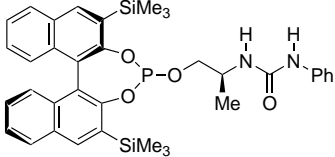
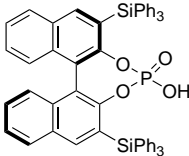

15-0582	Bis(4-trifluoromethylphenyl) (3-sulfonatophenyl)phosphine, sodium salt, min. 97% p-DAN2PHOS (1289463-87-1) C ₂₀ H ₁₂ F ₆ NaO ₃ PS; FW: 500.33; white powdr. Note: Sold under license from UAB for research purposes only. PCT/EP2010/065531.		100mg 500mg
15-1395	(R)-3,3'-Bis(2,4,6-triisopropylphenyl)-5,5',6,6',7,7',8,8'-octahydro-1,1'-binaphthyl-2,2'-diyl Hydrogenphosphate, 98%, (99% ee) (929294-27-9) C ₅₀ H ₆₅ O ₄ P; FW: 761; White to light-yellow powdr. Note: Sold in collaboration with Daicel for research purposes only.		100mg
15-1394	(S)-3,3'-Bis(2,4,6-triisopropylphenyl)-5,5',6,6',7,7',8,8'-octahydro-1,1'-binaphthyl-2,2'-diyl Hydrogenphosphate, 98%, (99% ee) (878111-20-7) C ₅₀ H ₆₅ O ₄ P; FW: 761; White to light-yellow powdr. Note: Sold in collaboration with Daicel for research purposes only.		100mg
15-2216	1-(2S)-1-[(11bR)-2,6-Bis(trimethylsilyl) dinaphtho[2,1-d:1',2'-f][1,3,2] dioxaphosphin-4-yloxy]propan-2-yl]-3-phenylurea, min. 97% (1357562-70-9) C ₃₆ H ₄₁ N ₃ O ₄ PSi ₂ ; FW: 652.87; white powdr. <i>moisture sensitive, (store cold)</i> Note: Sold under license from InCatT for research purposes only. WO2004/103559. UREAPhos and METAMORPhos Ligand Kit component. For detailed technical note visit strem.com .		50mg 250mg
93-1570 HAZ	Bis(triphenylphosphine)iminium borohydride, min. 97% (65013-26-5) [(C ₆ H ₅) ₃ P] ₂ NBH ₄ ; FW: 553.44; white powdr. <i>moisture sensitive</i>		2g 10g
15-0455	Bis(triphenylphosphine)iminium chloride, 97% (21050-13-5) [(C ₆ H ₅) ₃ P] ₂ NCI; FW: 574.04; white powdr.; m.p. 260-265°		5g 25g
15-0340 NEW	(R)-(-)-3,3'-Bis(triphenylsilyl)-1,1'-binaphthyl-2,2'-diyl hydrogen phosphate, min. 98% [(R)-TiPSY] (791616-55-2) C ₅₆ H ₄₁ O ₄ PSi ₂ ; FW: 865.07; white to light-yellow powdr.; m.p. 329-335° Note: Sold in collaboration with Daicel for research purposes only. For detailed technical note visit strem.com .		10mg 100mg
15-0341 NEW	(S)-(+)-3,3'-Bis(triphenylsilyl)-1,1'-binaphthyl-2,2'-diyl hydrogen phosphate, min. 98% [(S)-TiPSY] (929097-92-7) C ₅₆ H ₄₁ O ₄ PSi ₂ ; FW: 865.07; white to light-yellow solid; m.p. 329-335° Note: Sold in collaboration with Daicel for research purposes only. For detailed technical note visit strem.com .		10mg 100mg
15-0125	2-Bromophenyldiphenylphosphine, 98% (62336-24-7) C ₁₈ H ₁₄ BrP; FW: 341.18; white powdr.		1g 5g
96-5500	Buchwald Biaryl Phosphine Ligand Master Kit for Aromatic Carbon-Heteroatom Bond Formation, Suzuki Coupling and Negishi Cross-coupling See page 501		
96-5485	Buchwald Biaryl Phosphine Ligand Mini Kit 1 for Aromatic Carbon-Heteroatom Bond Formation, Suzuki Coupling and Negishi Cross-coupling See page 504		

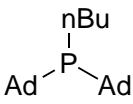
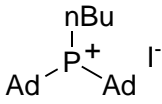
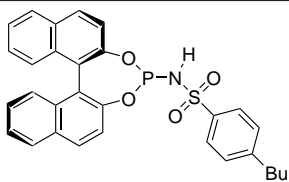
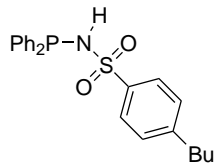
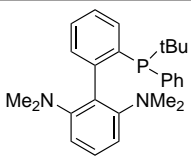
PHOSPHORUS (Compounds)

96-5490	Buchwald Biaryl Phosphine Ligand Mini Kit 2 for Aromatic Carbon-Heteroatom Bond Formation, Suzuki Coupling and Negishi Cross-coupling See page 505		
96-5495	Buchwald Biaryl Phosphine Ligand Mini Kit 3 for Aromatic Carbon-Heteroatom Bond Formation, Suzuki Coupling and Negishi Cross-coupling See page 505		
26-0324	4-(t-Butyl)-1,2-bis(diphenylphosphino)-1'-(di-i-propylphosphino)ferrocene, 98% HiersoPHOS-4 (776315-37-8) See page 99		
15-0483	Butyldi-1-adamantylphosphine, min. 95% [cataCXium® A] (321921-71-5) $C_4H_9(C_{10}H_{15})_2P$; FW: 358.54; white to yellow pwdr.; m.p. 100° <i>air sensitive</i> Note: Sold in collaboration with Solvias for research purposes only. Patent WO 0210178. Solvias cataCXium® Ligand Kit component. For detailed technical note visit strem.com .		1g 5g
15-0495	n-Butyl-di-(1-adamantyl)phosphonium iodide, min. 95% [cataCXium® AHI] (714951-87-8) $[(C_4H_9)(C_{10}H_{15})_2PH]^+I^-$; FW: 486.45; white pwdr. <i>light sensitive</i> Note: Sold in collaboration with Solvias for research purposes only. Patent US7148176. Solvias cataCXium® Ligand Kit component.		250mg 1g
15-0500	t-Butyldichlorophosphine, 98% (25979-07-1) $(CH_3)_3CPCl_2$; FW: 159.00; white to pale yellow xtl.; m.p. 47-48°; b.p. 146-148° <i>air sensitive, moisture sensitive</i>		2g 10g
15-0540	t-Butyldicyclohexylphosphine, min. 95% (93634-87-8) $[(CH_2)_6C](C_6H_{11})_2P$; FW: 254.40; colorless liq.; d. 0.939 <i>air sensitive</i>		500mg 2g
15-2218	4-Butyl-N-[(11bR)-dinaphtho[2,1-d:1',2'-f][1,3,2]dioxaphosphepin-4-yl]benzenesulfonamide triethylamine adduct, min. 97% (1150592-91-8) $C_{30}H_{26}NO_2PS \cdot (CH_3CH_2)_3N$; FW: 527.57 (628.76); white pwdr. <i>moisture sensitive, (store cold)</i> Note: Sold under license from InCaT for research purposes only. WO2009/065856. UREAPhos and METAMORPhos Ligand Kit component.		50mg 250mg
15-2220	4-Butyl-N-(diphenylphosphino)benzenesulfonamide, min. 97% (1025096-61-0) $C_{22}H_{26}NO_2PS$; FW: 397.47; white pwdr. <i>moisture sensitive, (store cold)</i> Note: Sold under license from InCaT for research purposes only. WO2009/065856. UREAPhos and METAMORPhos Ligand Kit component. For detailed technical note visit strem.com .		50mg 250mg
15-3010	2-(t-Butylphenylphosphino)-2',6'-dimethylamino-1,1'-biphenyl, 98% (t-Bu)PhCPhos (1660153-91-2) $C_{26}H_{33}N_2P$; FW: 404.53; white to off-white pwdr. Note: Patents: US 6,395,916, US 6,307,087 For detailed technical note visit strem.com .		250mg 1g 5g 25g
15-0966	t-Butylphosphine, min. 95% TBP (2501-94-2) $(C_4H_9)PH_2$; FW: 90.10; colorless liq.; b.p. 54°; d. 0.7 <i>pyrophoric, STENCH</i>		1g 5g

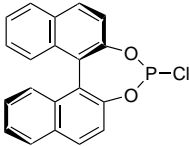
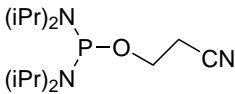

PHOSPHORUS (Compounds)

15-0967 HAZ	t-Butylphosphine, min. 95% TBP (10 wt% in hexanes) (2501-94-2) (C ₄ H ₉) ₃ PH ₂ ; FW: 90.10; colorless liq. <i>air sensitive</i>	10g 50g
26-1270	(R,S(p), R(SPO)-(1-t-Butylphosphinoyl)-2-[1-(diphenylphosphino)ethyl] ferrocene, min. 97% JoSPOphos (1221745-90-9) See page 100	
26-1271	(S, R(p), S(SPO)-(1-t-Butylphosphinoyl)-2-[1-(diphenylphosphino)ethyl] ferrocene, min. 97% JoSPOphos (1221746-31-1) See page 100	
96-5900	Chiral Quest Catalyst and Ligand Toolbox Kit for Asymmetric Hydrogenation See page 478	
28-0110	Chlorobis(triphenylphosphino)phenylnickel(II), 98% (33571-43-6) See page 173	
15-0690 NEW HAZ	Chloro(t-butyl)phenylphosphine, 97% (29949-69-7) C ₁₀ H ₁₄ ClP; FW: 200.65; colorless liq. <i>air sensitive, moisture sensitive</i>	1g 5g
15-0685	(R)-(-)-4-Chlorodinaphthol[2,1-d:1',2'-f][1,3,2]dioxaphosphepin, min. 97% (155613-52-8) C ₂₀ H ₁₂ ClO ₂ P; FW: 350.74; white powdr. <i>moisture sensitive</i>	1g 5g
		
15-0686	(S)-(+)-4-Chlorodinaphthol[2,1-d:1',2'-f][1,3,2]dioxaphosphepin, min. 97% (137156-22-0) C ₂₀ H ₁₂ ClO ₂ P; FW: 350.74; white powdr. <i>moisture sensitive</i>	1g 5g
15-0695	2-Cyanoethyl N,N,N',N'-tetra(i-propyl)phosphorodiamidite, min. 98% (102691-36-1) {[(CH ₃) ₂ CH] ₂ N}POCH ₂ CH ₂ CN; FW: 301.41; colorless liq.; b.p. 100° (0.5mm); d. 0.949 <i>moisture sensitive, (store cold)</i>	1g 5g
		
15-0795	(2-Cyanophenyl)diphenylphosphine, min. 98% (34825-99-5) (NCC ₆ H ₄)(C ₆ H ₅) ₂ P; FW: 287.30; white to off-white powdr.; m.p. 148-150°	500mg 2g
15-1010 HAZ	Cyclohexyldi-t-butylphosphine, 97% (436865-11-1) [(CH ₃) ₃ C] ₂ (C ₆ H ₁₁)P; FW: 228.36; colorless liq. <i>air sensitive</i>	500mg 2g
15-1011 NEW	Cyclohexyldi-t-butylphosphine, 98% (10wt% in hexanes) (436865-11-1) C ₁₄ H ₂₉ P; FW: 228.36; colorless liq. <i>air sensitive</i>	5g 25g
15-0800 amp HAZ	Cyclohexyldichlorophosphine, 98% (2844-89-5) C ₆ H ₁₁ PCl ₂ ; FW: 185.03; colorless liq.; b.p. 100°/17mm <i>air sensitive, moisture sensitive</i>	1g 5g
15-0900	Cyclohexyldiphenylphosphine, 98% (6372-42-5) (C ₆ H ₁₁)(C ₆ H ₅) ₂ P; FW: 268.34; white xtl.; m.p. 58-62° <i>air sensitive</i>	1g 5g
15-0950 amp HAZ 	Cyclohexylphosphine, min. 97% (822-68-4) C ₆ H ₁₁ PH ₂ ; FW: 116.14; colorless liq.; b.p. 145°; d. 0.8750 <i>pyrophoric</i>	10g 50g
15-0952 HAZ 	Cyclohexylphosphine, min. 97% (Sure/Seal™ bottle) (822-68-4) C ₆ H ₁₁ PH ₂ ; FW: 116.14; colorless liq.; b.p. 145°; d. 0.8750 <i>pyrophoric</i>	50g
15-0953 HAZ	Cyclohexylphosphine, min. 97% (10 wt% in hexanes) (822-68-4) C ₆ H ₁₁ PH ₂ ; FW: 116.14; colorless liq.; d. 0.684 <i>air sensitive</i>	100g

PHOSPHORUS (Compounds)

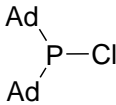
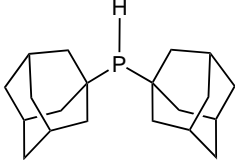
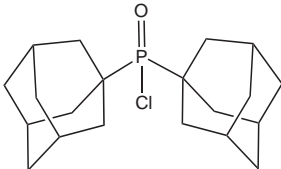
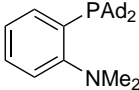
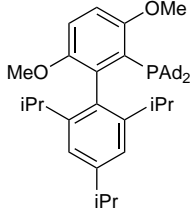
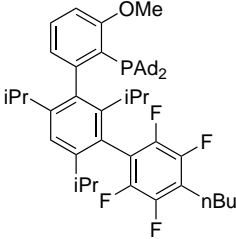
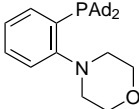
15-0958	n-Decylphosphonic acid, min. 97% (6874-60-8) CH ₃ (CH ₂) ₉ P(O)(OH) ₂ ; FW: 222.26; white to off-white powdr.; m.p. 103-104° Note: Long-Chain n-Alkylphosphonic Acid Kit component.		1g 5g
15-1095 HAZ	Di-1-adamantylchlorophosphine, min. 97% (157282-19-4) (C ₁₀ H ₁₆) ₂ ClP; FW: 336.88; white solid <i>moisture sensitive</i>		250mg 1g
15-0954	Di-1-adamantylphosphine, min. 97% (131211-27-3) (C ₁₀ H ₁₆) ₂ PH; FW: 302.43; white powdr. <i>air sensitive</i>		250mg 1g
15-0956	Di-1-adamantylphosphine oxide, min. 90% (131266-79-0) (C ₁₀ H ₁₆) ₂ P(O)H; FW: 318.43; white powdr.		250mg 1g
15-0955	Di-1-adamantylphosphinic chloride, 98% (126683-99-6) (C ₁₀ H ₁₆) ₂ POCl; FW: 352.88; white xtl.; m.p. 214° <i>moisture sensitive</i>		250mg 1g
15-1090	2-(Di-1-adamantylphosphino) dimethylaminobenzene, 97% Me-DalPhos (1219080-77-9) C ₂₈ H ₄₀ NP; FW: 421.60; white to yellow xtl. <i>air sensitive</i> For detailed technical note visit strem.com .		250mg 1g
15-1138	2-(Di-1-adamantylphosphino)-3,6-dimethoxy-2',4',6'-tri-<i>i</i>-propyl-1,1'-biphenyl, min. 95% AdBrettPhos (1160861-59-5) C ₄₃ H ₆₁ O ₂ P; FW: 640.92; off-white to pale yellow powdr. Note: Buchwald Biaryl Phosphine Ligand Master Kit component. Buchwald Biaryl Phosphine Ligand Mini Kit 1 component. Patents: US 6,395,916, US 6,307,087. For detailed technical note visit strem.com .		100mg 500mg 2g
15-2065 NEW	2-(Diadamantylphosphino)-3-methoxy-2',4',6'-tri-<i>i</i>-propyl-3'-(2,3,5,6-tetrafluoro-4-butylphenyl)-1,1'-biphenyl AlPhos (1805783-60-1) C ₅₂ H ₆₇ F ₄ OP; FW: 815.06; white to yellow powdr. <i>air sensitive</i> Note: Patents: US 6,395,916, US 6,307,087		100mg 500mg 2g
Technical Note: 1. See 46-0241 (page 227)			
15-1092	N-[2-(di-1-adamantylphosphino)phenyl]morpholine, 98% Mor-DalPhos (1237588-12-3) C ₃₀ H ₄₂ NOP; FW: 463.63; white to yellow xtl. <i>air sensitive</i> For detailed technical note visit strem.com .		250mg 1g 5g

PHOSPHORUS (Compounds)

15-0961	(1S,2S)-(-)-1,2-Diaminocyclohexane-N,N'-bis(2'-diphenylphosphinobenzoyl), 95% (S,S)-DACH-Phenyl Trost Ligand (169689-05-8) C ₄₄ H ₄₀ N ₂ O ₂ P ₂ ; FW: 690.76; white to off-white powdr.; m.p. 134-136° For detailed technical note visit strem.com.	100mg 500mg 2g
15-0960	(1R,2R)-(+)-1,2-Diaminocyclohexane-N,N'-bis(2'-diphenylphosphinobenzoyl), 98% (R,R)-DACH-Phenyl Trost Ligand (138517-61-0) C ₄₄ H ₄₀ N ₂ O ₂ P ₂ ; FW: 690.76; white to off-white powdr.; m.p. 134-136° For detailed technical note visit strem.com.	100mg 500mg 2g
15-0963	(1R,2R)-(+)-1,2-Diaminocyclohexane-N,N'-bis(2-diphenylphosphino-1-naphthoyl), min. 94% (R,R)-DACH-Naphthyl Trost Ligand (174810-09-4) C ₅₂ H ₄₄ N ₂ O ₂ P ₂ ; FW: 790.88; off-white powdr. For detailed technical note visit strem.com.	100mg 500mg 2g
15-0964	(1S,2S)-(-)-1,2-Diaminocyclohexane-N,N'-bis(2-diphenylphosphino-1-naphthoyl), min. 94% (S,S)-DACH-Naphthyl Trost Ligand (205495-66-5) C ₅₂ H ₄₄ N ₂ O ₂ P ₂ ; FW: 790.88; off-white powdr. For detailed technical note visit strem.com.	100mg 500mg 2g
15-1970	(2R,2'R,3R,3'R)-4,4'-Di(anthracen-9-yl)-3,3'-di-t-butyl-2,2',3,3'-tetrahydro-2,2'-bibenzo[d][1,3]oxaphosphole, min 98% (>90% ee), [(2R,2'R,3R,3'R)-WingPhos] (1884680-45-8) C ₅₀ H ₄₄ O ₂ P ₂ ; FW: 738.83; light yello powdr. <i>air sensitive, (store cold)</i> Note: Sold in collaboration with Zejun for research purposes only. Patents ZL201310020371.1, CN 201610056390. For detailed technical note visit strem.com.	25mg 100mg 500mg
15-1975	(2S,2'S,3S,3'S)-4,4'-Di(anthracen-9-yl)-3,3'-di-t-butyl-2,2',3,3'-tetrahydro-2,2'-bibenzo[d][1,3]oxaphosphole, min 98%, (>99% ee), [(2S,2'S,3S,3'S)-WingPhos] (1435940-19-4) C ₅₀ H ₄₄ O ₂ P ₂ ; FW: 738.83; light yellow powdr. <i>air sensitive, (store cold)</i> Note: Sold in collaboration with Zejun for research purposes only. Patents ZL201310020371.1, CN 201610056390.	25mg 100mg 500mg
Technical Note: 1. See 15-1970 (page 285)		
15-1157	2-Di[3,5-bis(trifluoromethyl)phenyl]phosphino-3,6-dimethoxy-2',4',6'-tri-i-propyl-1,1'-biphenyl, min. 98% JackiePhos (1160861-60-8) C ₃₉ H ₃₇ F ₁₂ O ₂ P ₂ ; FW: 796.66; white xtl.; m.p. 185-190° Note: Buchwald Biaryl Phosphine Ligand Master Kit component.. Buchwald Biaryl Phosphine Ligand Mini Kit 1 component.. Patents: US 6,395,916, US 6,307,087. For detailed technical note visit strem.com.	100mg 500mg 2g 10g
15-0990	Dibromotriphenylphosphorane, 98% (1034-39-5) (C ₆ H ₅) ₃ PBr ₂ ; FW: 422.10; light brown powdr. <i>air sensitive, moisture sensitive</i>	10g 50g

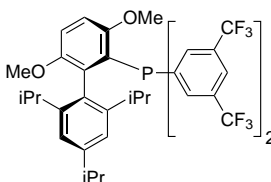
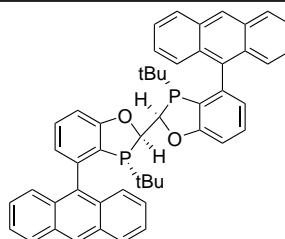
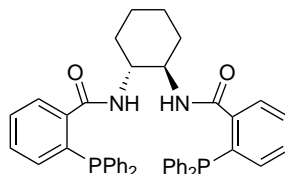

PHOSPHORUS (Compounds)

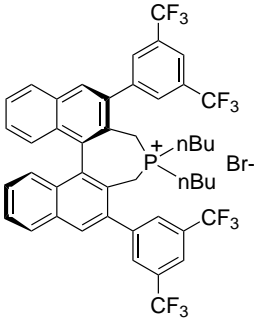
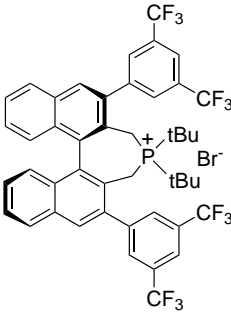
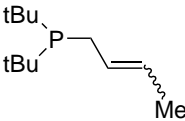
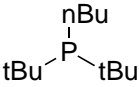
15-1457	(11bR)-(+)-4,4-Dibutyl-2,6-bis[3,5-bis(trifluoromethyl)phenyl]-4,5-dihydro-3H-dinaphtho[2,1-c:1',2'-e]phosphepinium bromide, 99% R-MARUOKA CAT P-NB [C ₄₆ H ₃₈ F ₁₂ P] ⁺ Br ⁻ ; FW: 929.65; white xtl.; m.p. 262-263° Note: Maruoka Chiral Phase-Transfer Phosphonium Organocatalyst Kit component. For detailed technical note visit strem.com .		50mg 250mg
15-1458	(11bS)-(-)-4,4-Dibutyl-2,6-bis[3,5-bis(trifluoromethyl)phenyl]-4,5-dihydro-3H-dinaphtho[2,1-c:1',2'-e]phosphepinium bromide, 99% S-Maruoka CAT P-NB (1110711-01-7) [C ₄₆ H ₃₈ F ₁₂ P] ⁺ Br ⁻ ; FW: 929.65; white xt.; m.p. 262-263° Note: Maruoka Chiral Phase-Transfer Phosphonium Organocatalyst Kit component. For detailed technical note visit strem.com .		50mg 250mg
15-1464	(11bR)-(+)-4,4-Di-t-butyl-2,6-bis[3,5-bis(trifluoromethyl)phenyl]-4,5-dihydro-3H-dinaphtho[2,1-c:1',2'-e]phosphepinium bromide, 99% R-MARUOKA CAT P-TB [C ₄₆ H ₃₈ F ₁₂ P] ⁺ Br ⁻ ; FW: 929.65; white xtl.; m.p. 202-204° Note: Maruoka Chiral Phase-Transfer Phosphonium Organocatalyst Kit component. For detailed technical note visit strem.com .		50mg 250mg
15-1465	(11bS)-(-)-4,4-Di-t-butyl-2,6-bis[3,5-bis(trifluoromethyl)phenyl]-4,5-dihydro-3H-dinaphtho[2,1-c:1',2'-e]phosphepinium bromide, 99% S-MARUOKA CAT P-TB [C ₄₆ H ₃₈ F ₁₂ P] ⁺ Br ⁻ ; FW: 929.65; white xtl.; m.p. 202-203° Note: Maruoka Chiral Phase-Transfer Phosphonium Organocatalyst Kit component. For detailed technical note visit strem.com .		50mg 250mg
15-1725	Di-t-butyl(2-butenyl)phosphine (40% in xylene), 98% m-Crophos® C ₁₂ H ₂₅ P; FW: 200.30; colorless liq.; b.p. 76-77° (4.0mm) <i>air sensitive</i> For detailed technical note visit strem.com .		5g 25g 100g
15-1128	Di-t-butyl(n-butyl)phosphine, min. 97% (29949-72-2) C ₁₂ H ₂₇ P; FW: 202.32; colorless liq. <i>air sensitive, pyrophoric</i>		250mg 1g 5g
15-1000	Di-t-butylchlorophosphine, min. 98% (13716-10-4) [(CH ₃) ₃ C] ₂ PCl; FW: 180.66; colorless to light yellow liq.; m.p. 2-3°; b.p. 69-70°/10 mm; f.p. 142°F; d. 0.951 <i>air sensitive, moisture sensitive</i>		1g 5g 25g

PHOSPHORUS (Compounds)

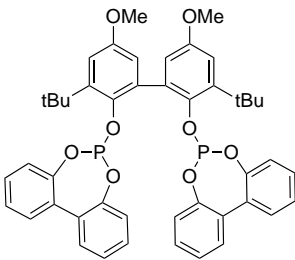
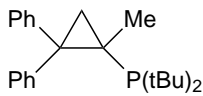
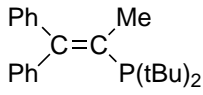
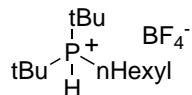
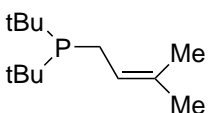
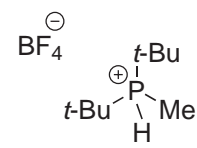
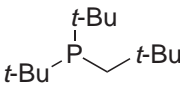
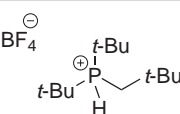
15-0107	6,6'-[(3,3'-Di- <i>t</i> -butyl-5,5'-dimethoxy-1,1'-biphenyl-2,2'-diyl)bis(oxy)] bis(dibenzo[d,f][1,3,2]dioxaphosphepin) hemi ethyl acetate adduct, min. 95% BIPHEPHOS (121627-17-6) C ₄₆ H ₄₄ O ₈ P ₂ ·0.5EtOAc; FW: 786.78 (830.84); white to off-white powdr.; m.p. 188-190° <i>air sensitive, moisture sensitive</i> For detailed technical note visit strem.com .		250mg 1g 5g
15-1005	Di- <i>t</i> -butyl(2,2-diphenyl-1-methyl-1-cyclopropyl)phosphine cBRIDP (742103-27-1) C ₂₄ H ₃₃ P; FW: 352.49; white to pale yellow solid <i>air sensitive, (store cold)</i> Note: Manufactured under license of Takasago patent US7129367B2. For detailed technical note visit strem.com .		250mg 1g 5g
15-1065	Di- <i>t</i> -butyl(2,2-diphenyl-1-methylvinyl)phosphine, min. 98% vBRIDP (384842-25-5) C ₂₃ H ₃₁ P; FW: 338.47; white to pale yellow xtl. <i>air sensitive, (store cold)</i> Note: Manufactured under license of Takasago patent US6455720. For detailed technical note visit strem.com .		250mg 1g 5g
15-7230	Di- <i>t</i> -butyl(<i>n</i> -hexyl)phosphonium tetrafluoroborate, 98% C ₁₄ H ₃₂ BF ₄ P; FW: 318.18; white powdr. <i>hygroscopic</i>		500mg 2g
15-1729	Di- <i>t</i> -butyl(3-methyl-2-butenyl)phosphine (40% in xylene), 98% Crophos® C ₁₃ H ₂₇ P; FW: 214.33; colorless liq. <i>air sensitive</i>		5g 25g 100g
15-1020	Di- <i>t</i> -butylmethylphosphine, 98+% (6002-40-0) amp HAZ [(CH ₃) ₂ C ₂ (CH ₃)P]; FW: 160.26; colorless liq.; d. 0.824 <i>air sensitive</i>		1g 5g
15-1023	Di- <i>t</i> -butylmethylphosphonium tetrafluoroborate, 99% (870777-30-3) (C ₄ H ₉) ₂ (CH ₃)PH ⁺ BF ₄ ⁻ ; FW: 248.05; white powdr. Note: Phosphine Ligand Kit component. For detailed technical note visit strem.com .		1g 5g
15-1017	Di- <i>t</i> -butylneopentylphosphine, min. 95% (DTBNpP) (60633-21-8) (C ₄ H ₉) ₂ (C ₅ H ₁₁)P; FW: 216.35; colorless to yellow liq. <i>pyrophoric</i> For detailed technical note visit strem.com .		1g 5g
15-1018	Di- <i>t</i> -butylneopentylphosphine, min. 95% (DTBNpP) (10 wt% in hexanes) (60633-21-8) (C ₄ H ₉) ₂ (C ₅ H ₁₁)P; FW: 216.35; colorless to pale yellow liq. <i>air sensitive</i>		10g 50g
15-1019	Di- <i>t</i> -butylneopentylphosphonium tetrafluoroborate, min. 95% (886059-84-3) [(C ₄ H ₉) ₂ (C ₅ H ₁₁)PH] ⁺ BF ₄ ⁻ ; FW: 304.17; white solid For detailed technical note visit strem.com .		1g 5g



PHOSPHORUS (Compounds)

15-1375 NEW	2,5-Di-<i>t</i>-butyl-1,4-phenylene tetraethyl bis(phosphonate), 99+% Redox shuttle ANL-RS6 (1350767-15-5) $C_{22}H_{40}O_8P_2$; FW: 494.50; white solid <i>air sensitive, moisture sensitive</i> Note: U.S. Patents: 8,969,625 For detailed technical note visit strem.com .		500mg 2g
15-1093	Di-<i>t</i>-butylphenylphosphine, min. 98% (50wt% in toluene) (32673-25-9) $C_{14}H_{23}P$; FW: 222.31; colorless liq. <i>air sensitive</i>		2g 10g
15-1028	Di-<i>t</i>-butylphenylphosphonium tetrafluoroborate, 97% $[(CH_3)_3C]_2(C_6H_5)PH^+BF_4^-$; FW: 310.12; white powd. For detailed technical note visit strem.com .		1g 5g
15-1030 amp HAZ 	Di-<i>i</i>-butylphosphine, min. 97% (4006-38-6) $(C_4H_9)_2PH$; FW: 146.21; colorless liq.; f.p. -1°F <i>air sensitive, pyrophoric</i>		1g 5g 25g
15-1031 HAZ	Di-<i>i</i>-butylphosphine, min. 97% (10 wt% in hexanes) (4006-38-6) $(C_4H_9)_2PH$; FW: 146.22; colorless liq. <i>air sensitive</i>		10g 50g 250g
15-1040 amp HAZ 	Di-<i>t</i>-butylphosphine, 98+% (819-19-2) $[(CH_3)_3C]_2PH$; FW: 146.22; colorless liq.; m.p. -17°; b.p. 38-40°; f.p. -1°F; d. 0.790 <i>pyrophoric</i>		1g 5g 25g
15-1042 HAZ	Di-<i>t</i>-butylphosphine, 98+% (10 wt% in hexanes) (819-19-2) $[(CH_3)_3C]_2PH$; FW: 146.22; colorless liq. <i>air sensitive</i>		50g 250g
15-1041	Di-<i>t</i>-butylphosphine oxide, 98% (684-19-5) $(C_4H_9)_2P(O)H$; FW: 162.21; white xtl. <i>hygroscopic</i>		250mg 1g
15-1043	racemic-2-Di-<i>t</i>-butylphosphino-1, 1'-binaphthyl, 98% TrixiePhos (255836-67-0) $C_{28}H_{31}P$; FW: 398.53; white xtl.; m.p. 147-149° Note: Buchwald Biaryl Phosphine Ligand Master Kit component.. Buchwald Biaryl Phosphine Ligand Mini Kit 2 component.. Patents: US 6,395,916, US 6,307,087. For detailed technical note visit strem.com .		250mg 1g 5g
15-1045	2-(Di-<i>t</i>-butylphosphino)-1,1'-biphenyl, 99% JohnPhos (224311-51-7) $C_{20}H_{27}P$; FW: 298.41; white xtl.; m.p. 85° Note: Phosphine Ligand Kit component. Note: Buchwald Biaryl Phosphine Ligand Master Kit component.. Buchwald Biaryl Phosphine Ligand Mini Kit 2 component.. Patents: US 6,395,916, US 6,307,087. For detailed technical note visit strem.com .		500mg 2g 10g 50g
15-1164	2-(Di-<i>t</i>-butylphosphino)-3,6-dimethoxy-2',4',6'-tri-<i>i</i>-propyl-1,1'-biphenyl, min. 98% t-BuBrettPhos (1160861-53-9) $C_{31}H_{49}O_2P$; FW: 484.69; white xtl. Note: Buchwald Biaryl Phosphine Ligand Master Kit component.. Buchwald Biaryl Phosphine Ligand Mini Kit 1 component.. Patents: US 6,395,916, US 6,307,087. For detailed technical note visit strem.com .		100mg 500mg 2g 10g 50g

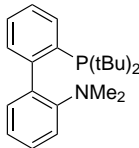
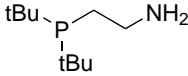
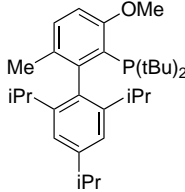
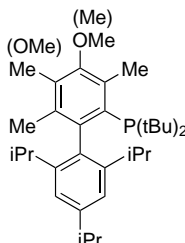
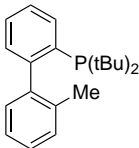
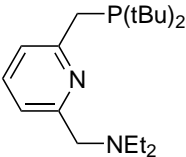
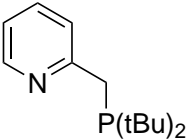
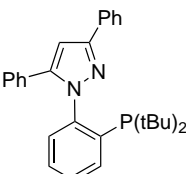
PHOSPHORUS (Compounds)

15-1048	2-Di-t-butylphosphino-2'-(N,N-dimethylamino)-1,1'-biphenyl, 98% tBuDavePhos (224311-49-3) $(\text{C}_8\text{H}_9)_2\text{NC}_6\text{H}_4\text{C}_6\text{H}_4\text{P}(\text{C}_4\text{H}_9)_2$; FW: 341.47; white xtl. Note: Buchwald Biaryl Phosphine Ligand Master Kit component.. Buchwald Biaryl Phosphine Ligand Mini Kit 2 component.. Patents: US 6,395,916, US 6,307,087. For detailed technical note visit strem.com .		500mg 2g 10g
15-7128 HAZ	2-(Di-t-butylphosphino)ethylamine, min. 97% (10 wt% in THF) (1053658-84-6) $(\text{tBu})_2\text{P}(\text{CH}_2)_2\text{NH}_2$; FW: 189.28; pale yellow to colorless liq. <i>air sensitive, moisture sensitive</i>		5g 25g
15-1168	2-(Di-t-butylphosphino)-3-methoxy-6-methyl-2',4',6'-tri-i-propyl-1,1'-biphenyl, min. 98% RockPhos (1262046-34-3) $\text{C}_{31}\text{H}_{49}\text{OP}$; FW: 468.69; white xtl.; m.p. 129-130° Note: Patents: US 6,395,916, US 6,307,087. For detailed technical note visit strem.com .		100mg 500mg 2g
15-1063	2-Di-t-butylphosphino-4-methoxy-3,5,6-trimethyl-2',4',6'-tri-i-propyl-1,1'-biphenyl, min. 98% [-1:1 mixture with regioisomer, 2-Di-t-butylphosphino-5-methoxy-3,4,6-trimethyl-2',4',6'-tri-i-propylbiphenyl] (1359986-21-2) $\text{C}_{33}\text{H}_{53}\text{OP}$; FW: 496.75; white powdr. Note: Patents: US 6,395,916, US 6,307,087 For detailed technical note visit strem.com .		250mg 1g 5g
15-1049	2-Di-t-butylphosphino-2'-methyl-1,1'-biphenyl, 99% t-BuMePhos (255837-19-5) $\text{C}_{21}\text{H}_{29}\text{P}$; FW: 312.43; white xtl. Note: Buchwald Biaryl Phosphine Ligand Master Kit component.. Buchwald Biaryl Phosphine Ligand Mini Kit 2 component.. Patents: US 6,395,916, US 6,307,087. For detailed technical note visit strem.com .		500mg 2g 10g 50g
15-0073	2-(Di-t-butylphosphinomethyl)-6-(diethylaminomethyl)pyridine, 98% (863971-66-8) $\text{C}_{19}\text{H}_{35}\text{N}_2\text{P}$; FW: 322.47; yellow liq. <i>air sensitive</i> For detailed technical note visit strem.com .		100mg 500mg
15-7350	2-(Di-t-butylphosphinomethyl)pyridine, 99% (494199-72-3) $\text{C}_{14}\text{H}_{24}\text{NP}$; FW: 237.32; pale yellow liq. <i>air sensitive</i>		100mg 500mg
15-1720 NEW	1-(2-Di-t-butylphosphinophenyl)-3,5-diphenyl-1H-pyrazole, 98% (628333-86-8) $\text{C}_{20}\text{H}_{33}\text{N}_2\text{P}$; FW: 440.56; white xtl.; m.p. 138-142° <i>air sensitive</i>		250mg 1g

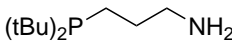
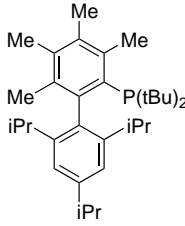
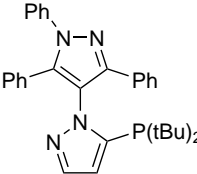
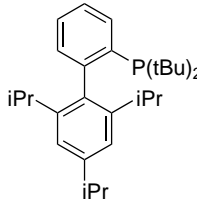

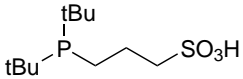
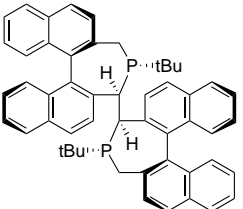
PHOSPHORUS (Compounds)

15-7130 HAZ	3-(Di-t-butylphosphino)propylamine, min. 97% (10 wt% in THF) (1196147-72-4) C ₁₁ H ₂₆ NP; FW: 203.30; pale yellow to colorless liq. <i>air sensitive</i>		5g 25g
15-1051	2-Di-t-butylphosphino-3,4,5,6-tetramethyl-2',4',6'-tri-i-propyl-1,1'-biphenyl, min. 98% Me₄ t-BuXPhos (857356-94-6) C ₃₃ H ₅₃ P; FW: 480.75; white microxtl.; m.p. 166-168° Note: Buchwald Biaryl Phosphine Ligand Master Kit component.. Buchwald Biaryl Phosphine Ligand Mini Kit 1 component.. Patents: US 6,395,916, US 6,307,087. For detailed technical note visit strem.com .		250mg 1g 5g 25g
15-1037	5-(Di-t-butylphosphino)-1',3',5'-triphenyl-1,4'-bi-1H-pyrazole, min. 95% t-Bu-BippyPhos (894086-00-1) C ₃₂ H ₃₅ N ₄ P; FW: 506.62; white to pale yellow solid; m.p. 169-173° <i>air sensitive</i>		250mg 1g
15-1052	2-Di-t-butylphosphino-2',4',6'-tri-i-propyl-1,1'-biphenyl, min. 98% t-BuXPhos (564483-19-8) C ₂₆ H ₄₅ P; FW: 424.64; white xtl.; m.p. 147-149° Note: Buchwald Biaryl Phosphine Ligand Master Kit component.. Buchwald Biaryl Phosphine Ligand Mini Kit 1 component.. Patents: US 6,395,916, US 6,307,087. For detailed technical note visit strem.com .		500mg 2g 10g 50g 250g
93-1518	Di-n-butylphosphite, 96% (1809-19-4) (C ₄ H ₉) ₂ P(O)H; FW: 194.21; colorless liq.; b.p. 118-119°/11 mm; f.p. 250°F; d. 0.995		50g 250g
15-1054 HAZ 	Di-t-butyl(i-propyl)phosphine, min. 98% (25032-49-9) (C ₄ H ₉) ₂ (C ₃ H ₇)P; FW: 118.29; colorless liq. <i>pyrophoric</i>		250mg 1g
15-1067	Di-t-butyl(3-sulfonatopropyl)phosphine, min. 98% (1055888-89-5) (C ₄ H ₉) ₂ PCH ₂ CH ₂ CH ₂ SO ₃ H; FW: 268.35; white solid <i>moisture sensitive</i>		250mg 1g
15-1053 NEW	(3S,3'S,4S,4'S,11bS,11'bS)-(+)-4,4'-Di-t-butyl-4,4',5,5'-tetrahydro-3,3'-bi-3H-dinaphtho[2,1-c:1',2'-e]phosphepin, 97% (S)-BINAPINE (610304-81-9) C ₅₂ H ₄₈ P ₂ ; FW: 734.89; white to light yellow pwdr. <i>air sensitive</i> Note: Sold in collaboration with Chiral Quest for research purposes only. US Patent No. 7105702, 7153809, 7169953. For detailed technical note visit strem.com .		50mg 250mg

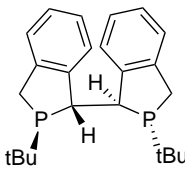
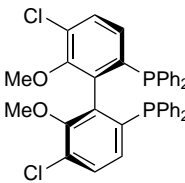
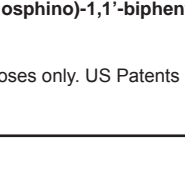
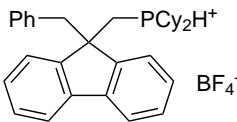
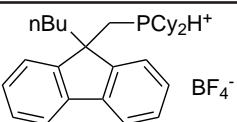
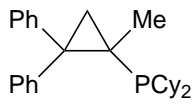
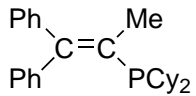
PHOSPHORUS (Compounds)

15-1060	(1R,1'R,2S,2'S)-(+)-2,2'-Di- <i>t</i> -butyl-2,3,2',3'-tetrahydro-1,1'-bi-1 <i>H</i> -isosphindole, min. 98% (R,R,S,S)-DUANPHOS (528814-26-8) C ₂₄ H ₃₂ P ₂ ; FW: 382.46; white xtl. <i>air sensitive</i> Note: Sold in collaboration with the Chiral Quest for research purposes only. Patent pending, PCT/US02/35788. Chiral Quest Catalyst and Ligand Toolbox Kit component. For detailed technical note visit strem.com .		100mg 500mg
15-1055	(R)-(+)-5,5'-Dichloro-6,6'-dimethoxy-2,2'-bis(diphenylphosphino)-1,1'-biphenyl, min. 95% (R)-Cl-MeO-BIPHEP (185913-97-7) C ₃₈ H ₃₀ Cl ₂ O ₂ P ₂ ; FW: 651.50; yellow-white powdr.; m.p. 178° Note: Sold in collaboration with Lanxess for research purposes only. US Patents 5,710,339 and 5,801,261. For detailed technical note visit strem.com .		250mg 1g
15-1056	(S)-(-)-5,5'-Dichloro-6,6'-dimethoxy-2,2'-bis(diphenylphosphino)-1,1'-biphenyl, min. 95% (S)-Cl-MeO-BIPHEP (185913-98-8) C ₃₈ H ₃₀ Cl ₂ O ₂ P ₂ ; FW: 651.50; yellow-white powdr.; m.p. 178° Note: Sold in collaboration with Lanxess for research purposes only. US Patents 5,710,339 and 5,801,261. For detailed technical note visit strem.com .		250mg 1g
26-0985	Dichlorophosphinoferrrocene, 98% (1291-31-2) See page 101		
15-1072	Dicyclohexyl(9-benzylfluoren-9-yl)phosphonium tetrafluoroborate, min. 97% [cataCXium® FBn] (937378-18-2) C ₃₂ H ₃₈ BF ₄ P; FW: 540.42; white powdr. <i>air sensitive</i> Note: Sold in collaboration with Solvias for research purposes only. Patent Application Pending. Solvias cataCXium® Ligand Kit component.		500mg 2g
15-1074	Dicyclohexyl(9-butylfluoren-9-yl)phosphonium tetrafluoroborate, min. 95% [cataCXium® FBu] (1007311-98-9) C ₂₈ H ₄₀ BF ₄ P; FW: 506.41; white powdr. Note: Sold in collaboration with Solvias for research purposes only. Patent Application Pending. Solvias cataCXium® Ligand Kit component.		500mg 2g
15-1050 amp HAZ	Dicyclohexylchlorophosphine, min. 98% (16523-54-9) (C ₆ H ₁₁) ₂ PCl; FW: 232.74; colorless to pale yellow, cloudy liq.; b.p. 96-99°/0.1 mm; d. 1.054 <i>air sensitive, moisture sensitive</i>		1g 5g
15-1007	Dicyclohexyl(2,2-diphenyl-1-methylcyclopropyl)phosphine Cy-cBRIDP (1023330-38-2) C ₂₈ H ₃₇ P; FW: 404.57; white to pale yellow solid <i>air sensitive, (store cold)</i> Note: Manufactured under license of Takasago patent US7129367B2. For detailed technical note visit strem.com .		250mg 1g 5g
15-1062	Dicyclohexyl(2,2-diphenyl-1-methylvinyl)phosphine Cy-vBRIDP (384842-24-4) C ₂₅ H ₃₅ P; FW: 366.52; white to pale yellow solid <i>air sensitive, (store cold)</i> Note: Manufactured under license of Takasago patent US6455720. For detailed technical note visit strem.com .		250mg 1g 5g

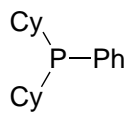
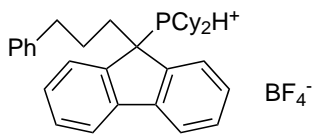
PHOSPHORUS (Compounds)

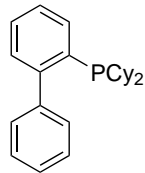
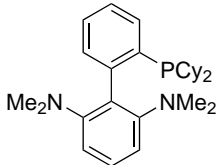
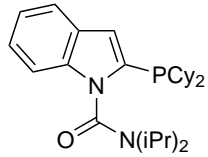
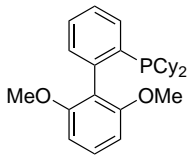
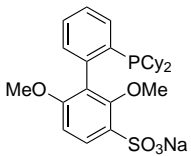
15-1100	Dicyclohexylphenylphosphine, min. 95% (6476-37-5) (C ₆ H ₁₁) ₂ (C ₆ H ₅)P; FW: 274.38; white solid <i>air sensitive</i>		1g 5g
15-1076	Dicyclohexyl[9-(3-phenylpropyl)fluoren-9-yl] phosphonium tetrafluoroborate, min. 95% [cataCXium® FPrPh] (1007311-95-6) C ₃₄ H ₄₂ BF ₄ P; FW: 568.48; white powdr. <i>air sensitive</i> Note: Sold in collaboration with Solvias for research purposes only. Patent Application Pending. Solvias cataCXium® Ligand Kit component.		500mg 2g
15-1120 amp HAZ 	Dicyclohexylphosphine, 98% (829-84-5) (C ₆ H ₁₁) ₂ PH; FW: 198.29; light yellow liq.; b.p. 129°/8 mm; d. 0.98 <i>pyrophoric</i>		2g 10g 50g
15-1122 HAZ	Dicyclohexylphosphine, 98% (10 wt% in hexanes) (829-84-5) (C ₆ H ₁₁) ₂ PH; FW: 198.29; colorless liq. <i>air sensitive</i>		20g 100g
15-1140	2-(Dicyclohexylphosphino)-1,1'-biphenyl, 98% CyJohnPhos (247940-06-3) C ₂₄ H ₃₁ P; FW: 350.49; white xtl.; m.p. 103° Note: Buchwald Biaryl Phosphine Ligand Master Kit component.. Buchwald Biaryl Phosphine Ligand Mini Kit 2 component.. Patents: US 6,395,916, US 6,307,087. For detailed technical note visit strem.com .		1g 5g 25g 100g
15-1147	2-Dicyclohexylphosphino-2',6'-bis(dimethylamino)-1,1'-biphenyl, min. 98% CPhos (1160556-64-8) C ₂₈ H ₄₁ N ₂ P; FW: 436.61; yellow-orange xtl.; m.p. 111-113° Note: Patents: US 6,395,916, US 6,307,087 For detailed technical note visit strem.com .		250mg 1g 5g
15-1086	2-(Dicyclohexylphosphino)-N,N-bis(1-methylethyl)-1H-indole-1-carboxamide, min. 98% Amidole-Phos (1067175-36-3) C ₂₇ H ₄₁ N ₂ OP; FW: 440.60; white to off-white powdr.; m.p. 192.1-193.8° For detailed technical note visit strem.com .		100mg 500mg
15-1143	2-Dicyclohexylphosphino-2',6'-dimethoxy-1,1'-biphenyl, min. 98% SPhos (657408-07-6) C ₂₆ H ₃₅ O ₂ P; FW: 410.53; white xtl.; m.p. 164-166° Note: Buchwald Biaryl Phosphine Ligand Master Kit component. Buchwald Biaryl Phosphine Ligand Mini Kit 1 component. Patents: US 6,395,916, US 6,307,087. For detailed technical note visit strem.com .		500mg 2g 10g 50g
15-1142	2'-Dicyclohexylphosphino-2,6-dimethoxy-3-sulfonato-1,1'-biphenyl hydrate sodium salt (water soluble SPhos), min. 98% (1049726-96-6) C ₂₆ H ₃₄ NaO ₅ PS·XH ₂ O; FW: 512.58; light yellow solid Note: Water soluble version of 15-1143 S-Phos. Buchwald Biaryl Ligand Master Kit component. Patents: US 6,395,916 and US 6,307,087. For detailed technical note visit strem.com .		500mg 2g 10g

PHOSPHORUS (Compounds)

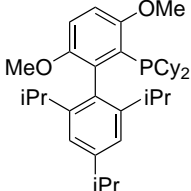
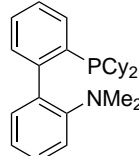
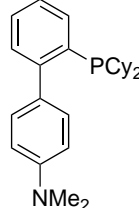
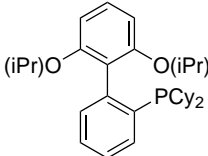
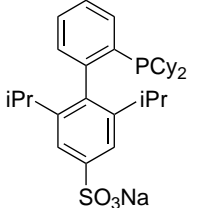
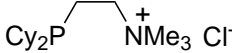
15-1152	2-(Dicyclohexylphosphino)-3,6-dimethoxy-2',4',6'-tri-<i>i</i>-propyl-1,1'-biphenyl, min. 98% BrettPhos (1070663-78-3) $C_{36}H_{53}O_2P$; FW: 536.77; white xtl.; m.p. 191-193° Note: Buchwald Biaryl Phosphine Ligand Master Kit component.. Buchwald Biaryl Phosphine Ligand Mini Kit 1 component.. Patents: US 6,395,916, US 6,307,087. For detailed technical note visit strem.com .		250mg 1g 5g 25g 100g
15-1145	2-(Dicyclohexylphosphino)-2'-(N,N-dimethylamino)-1,1'-biphenyl, 98% DavePhos (213697-53-1) $C_{26}H_{36}NP$; FW: 393.55; white xtl.; m.p. 115-119° Note: Buchwald Biaryl Phosphine Ligand Master Kit component. Buchwald Biaryl Phosphine Ligand Mini Kit 2 component. Patents: US 6,395,916, US 6,307,087. For detailed technical note visit strem.com .		500mg 2g 10g 50g
15-1154	2-Dicyclohexylphosphino-4'-(N,N-dimethylamino)-1,1'-biphenyl, 98% (1185899-00-6) $C_{26}H_{36}NP$; FW: 393.55; white xtl. Note: Patents: US 6,395,916, US 6,307,087. For detailed technical note visit strem.com .		250mg 1g 5g
15-1146	2-Dicyclohexylphosphino-2',6'-di-<i>i</i>-propoxy-1,1'-biphenyl, min. 98% RuPhos (787618-22-8) $C_{30}H_{43}O_2P$; FW: 466.64; white powdr.; m.p. 123-124° Note: Buchwald Biaryl Phosphine Ligand Master Kit component. Buchwald Biaryl Phosphine Ligand Mini Kit 1 component. Patents: US 6,395,916, US 6,307,087. For detailed technical note visit strem.com .		1g 5g 25g 100g
15-1135	2'-Dicyclohexylphosphino-2,6-di-<i>i</i>-propyl-4-sulfonato-1,1'-biphenyl hydrate sodium salt (XPhos-SO₃Na) (870245-84-4) $C_{30}H_{42}NaO_3PS \cdot XH_2O$; FW: 536.68; beige solid Note: Water soluble phosphine. Buchwald Biaryl Phosphine Ligand Master Kit component. Patents: US 6,395,916, US 6,307,087. For detailed technical note visit strem.com .		100mg 500mg 2g
15-1144	[2-(Dicyclohexylphosphino)ethyl]trimethylammonium chloride, min. 95% (181864-78-8) $(C_6H_{11})_2PCH_2CH_2N(CH_3)_3^+Cl^-$; FW: 319.89; white powdr. <i>hygroscopic</i>		1g 5g
26-0955	(S)-(-)-[(S)-2-Dicyclohexylphosphinoferrocenyl]([N,N-dimethylamino)(2-dicyclohexylphosphinophenyl)methane, min. 97% (914089-00-2) See page 101		
26-0975	(R)-(-)-1-[(S)-2-(Dicyclohexylphosphino)ferrocenyl]ethyl-di-<i>t</i>-butylphosphine, min. 97% (158923-11-6) See page 101		
26-1000	(R)-(-)-1-[(S)-2-(Dicyclohexylphosphino) ferrocenyl]ethyl-dicyclohexylphosphine, min. 97% (167416-28-6) See page 101		

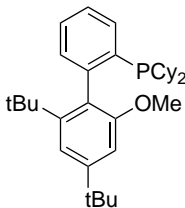
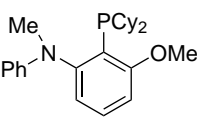
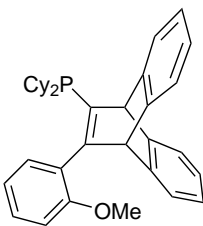
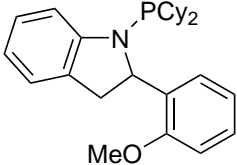
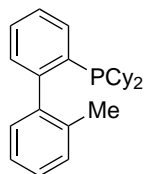
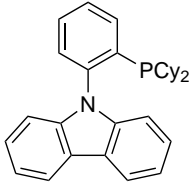

PHOSPHORUS (Compounds)

26-1001	(S)-(+)-1-[(R)-2-(Dicyclohexylphosphino)ferrocenyl]ethyl dicyclohexylphosphine, min. 97% (246231-77-6) See page 101		
26-1230	(R)-(-)-1-[(S)-2-(Dicyclohexylphosphino)ferrocenyl]ethyl diphenylphosphine, min. 97% (158923-09-2) See page 101		
26-1101	(S)-(+)-1-[(R)-2-(Dicyclohexylphosphino)ferrocenyl]ethyl diphenylphosphine, min. 97% (162291-01-2) See page 101		
15-1105 NEW	2-Dicyclohexylphosphino-2'-methoxy-4',6'-di- <i>t</i> -butyl-1,1'-biphenyl, min. 98% VPhos (1848244-75-6) C ₃₃ H ₄₉ OP; FW: 492.72; white to off-white solid Note: Patents: US 6,395,916, US 6,307,087 For detailed technical note visit strem.com .		250mg 1g 5g
15-6528 NEW	[2-Dicyclohexylphosphino-3-methoxy-N-methyl-N-phenylbenzenamine, 98% Zheda-Phos (1398565-95-1) C ₂₆ H ₃₆ NOP; FW: 409.54; white powdr.; m.p. 169-170° Note: Sold under license from ZJU for research purposes only. Patent CN201210146220.6, PCT/CN2012/078129. For detailed technical note visit strem.com .		250mg 1g
15-1082	11-Dicyclohexylphosphino-12-(2-methoxyphenyl)-9,10-ethenoanthracene dichloromethane adduct, min. 98% o-MeO-KITPHOS (1166994-78-0) C ₃₅ H ₃₉ OP; FW: 506.66; white powdr. Note: Sold under license from NCL for research purposes only. Patent Pending. For detailed technical note visit strem.com .		100mg 500mg
15-1087	1-(Dicyclohexylphosphino)-2-(2-methoxyphenyl)-1H-indole, min. 98% NPCy o-An-dole-Phos (947402-60-0) C ₂₇ H ₃₄ NOP; FW: 419.54; white to off-white powdr.; m.p. 131.1-132.5° For detailed technical note visit strem.com .		100mg 500mg
15-1148	2-Dicyclohexylphosphino-2'-methyl-1,1'-biphenyl, min. 98% MePhos (251320-86-2) C ₂₅ H ₃₃ P; FW: 364.51; white xtl.; m.p. 107-110° Note: Buchwald Biaryl Phosphine Ligand Master Kit component. Buchwald Biaryl Phosphine Ligand Mini Kit 2 component. Patents: US 6,395,916, US 6,307,087. For detailed technical note visit strem.com .		500mg 2g 10g 50g
15-0445	9-[2-(Dicyclohexylphosphino) phenyl]-9H-carbazole, min. 98% PhenCar-Phos (1308652-64-3) C ₃₀ H ₃₄ NP; FW: 439.57; white powdr. <i>air sensitive</i> Note: PhenCar-Phos Ligand Kit component. For detailed technical note visit strem.com .		250mg 1g

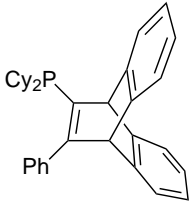
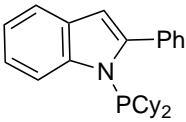
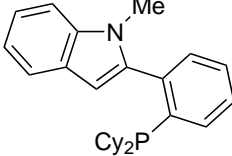
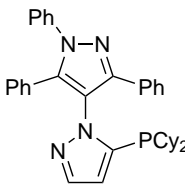
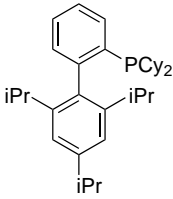
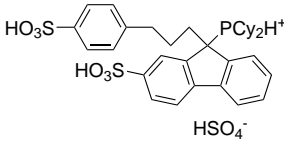
PHOSPHORUS (Compounds)

15-1084	<p>11-Dicyclohexylphosphino-12-phenyl-9,10-ethanoanthracene dichloromethane adduct, min. 98% KITPHOS (1166994-77-9) $C_{34}H_{37}P$; FW: 476.63; white powdr. Note: Sold under license from NCL for research purposes only. Patent Pending. For detailed technical note visit strem.com.</p>		100mg 500mg
26-1120	<p>(R)-(+)-1-[(R)-2-(2'-Dicyclohexylphosphinophenyl)ferrocenyl]ethyl-bis(3,5-trifluoromethylphenyl)phosphine, min. 97% (821009-34-1) See page 102</p>		
15-1089	<p>1-(Dicyclohexylphosphino)-2-phenyl-1H-indole, min. 98% NPCy Phendole-Phos (947402-57-5) $C_{26}H_{32}NP$; FW: 389.51; white to off-white powdr. For detailed technical note visit strem.com.</p>		100mg 500mg
15-1088	<p>2-[2-(Dicyclohexylphosphino)phenyl]-1-methyl-1H-indole, min. 98% CM-Phos (1067883-58-2) $C_{27}H_{34}NP$; FW: 403.54; white to off-white powdr.; m.p. 171.9-174.9° For detailed technical note visit strem.com.</p>		100mg 500mg
15-1039	<p>5-(Dicyclohexylphosphino)-1',3',5'-triphenyl-[1,4']-bi-1H-pyrazole, min. 95% Cy-BippyPhos (1021176-69-1) $C_{36}H_{39}N_4P$; FW: 558.70; white powdr. <i>air sensitive</i></p>		250mg 1g
15-1149	<p>2-(Dicyclohexylphosphino)-2',4',6'-tri-i-propyl-1,1'-biphenyl, min. 98% XPhos (564483-18-7) $C_{33}H_{49}P$; FW: 476.72; white powdr.; m.p. 185° Note: Buchwald Biaryl Phosphine Ligand Master Kit component. Buchwald Biaryl Phosphine Ligand Mini Kit 1 component. Patents: US 6,395,916, US 6,307,087. For detailed technical note visit strem.com.</p>		500mg 2g 10g 100g 500g
15-1078	<p>Dicyclohexyl-[9-[3-(4-sulfonylphenyl)propyl]-2-sulfonylfluoren-9-yl]phosphonium hydrogen sulfate, min. 95% [cataCXium® FSulf] $C_{34}H_{43}O_{10}PS_3$; FW: 738.87 Note: Sold in collaboration with Solvias for research purposes only. Patent Application Pending. Solvias cataCXium® Ligand Kit component.</p>		500mg 2g
15-1130	<p>Dicyclopentylphosphine, 97+% (39864-68-1) $(C_5H_9)_2PH$; FW: 170.23; colorless liq.; d. 0.933 <i>air sensitive, pyrophoric</i></p>		1g 5g
15-1131	<p>Dicyclopentylphosphine, 97+% (10 wt% in hexanes) (39864-68-1) $(C_5H_9)_2PH$; FW: 170.23; colorless liq. <i>air sensitive</i></p>		10g 50g

PHOSPHORUS (Compounds)

15-1150 amp HAZ	Diethylchlorophosphine, min. 95% (686-69-1) (C ₂ H ₅) ₂ PCl; FW: 124.55; colorless to light yellow liq.; b.p. 131-132°; f.p. 66°F; d. 1.023 <i>air sensitive, moisture sensitive, (store cold)</i>	1g 5g
93-1520 HAZ	Di-(2-ethylhexyl)phosphoric acid (contains some mono) (298-07-7) [C ₁₄ H ₃₀ CH(C ₂ H ₅)CH ₂ O] ₂ P(O)(OH); FW: 322.42; colorless liq.; d. 0.974	100g 500g
15-1210 amp HAZ 	Diethylphosphine, 99% (627-49-6) (C ₂ H ₅) ₂ PH; FW: 90.11; colorless liq.; b.p. 85°; d. 0.7862 <i>pyrophoric, STENCH</i>	1g 5g
15-1211 HAZ	Diethylphosphine, 99% (10 wt% in hexanes) (627-49-6) (C ₂ H ₅) ₂ PH; FW: 90.11; colorless liq.; d. 0.66 <i>air sensitive</i>	10g 50g
15-1151 	2-Diethylphosphino-2',6'-bis(dimethylamino)-1,1'-bi-phenyl di(hydrogen tetrafluoroborate) salt, min. 98% EtCPhos C ₂₀ H ₂₉ N ₂ P·2(HBF ₄); FW: 504.01; white powdr. Note: Patents: US 6,395,916, US 6,307,087. For detailed technical note visit strem.com .	100mg 500mg
15-0496	9-[2-(Diethylphosphino)phenyl]-9H-carbazole, min. 97% Et PhenCar-Phos (1308652-66-5) C ₂₂ H ₂₂ NP; FW: 331.39; white powdr. <i>air sensitive</i> Note: PhenCar-Phos Ligand Kit component.	100mg 500mg
93-1521	Diethylphosphite, min. 95% (762-04-9) (C ₂ H ₅ O) ₂ P(O)H; FW: 138.11; colorless liq.; b.p. 50-51°/2 mm; f.p. 195°F; d. 1.072	100g 500g
15-7332	2-2-[(2R,5R)-2,5-Diethyl-1-phospholano]phenyl]1,3-dioxolane, min. 97% C ₁₇ H ₂₅ O ₂ P; FW: 292.35; pale yellow to colorless liq. <i>air sensitive</i> Note: Sold under license from Kanata for research purposes only.	100mg 500mg
15-7333	2-2-[(2S,5S)-2,5-Diethyl-1-phospholano]phenyl]1,3-dioxolane, min. 97% (1217655-83-8) C ₁₇ H ₂₅ O ₂ P; FW: 292.35; pale yellow to colorless liq. <i>air sensitive</i> Note: Sold under license from Kanata for research purposes only.	100mg 500mg
15-7354	[1-(2R,5R)-2,5-Diethylphospholanyl]-[2-(2R,5R)-2,5-diethylphospholanyl-1-oxide]benzene, min. 97% (924294-55-3) C ₂₂ H ₃₆ OP ₂ ; FW: 378.47; pale yellow to colorless liq. <i>air sensitive</i> Note: Sold under license from Kanata for research purposes only.	100mg 500mg
15-7355	[1-(2S,5S)-2,5-Diethylphospholanyl]-[2-(2S,5S)-2,5-diethylphospholanyl-1-oxide]benzene, min. 97% C ₂₂ H ₃₆ OP ₂ ; FW: 378.47; pale yellow to colorless liq. <i>air sensitive</i> Note: Sold under license from Kanata for research purposes only.	100mg 500mg

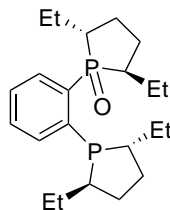
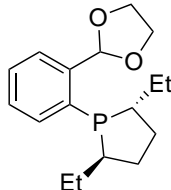
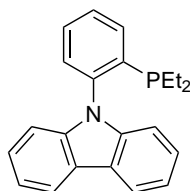
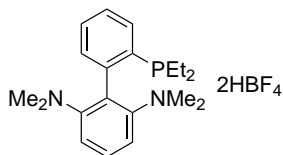

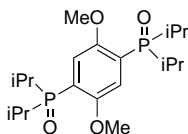
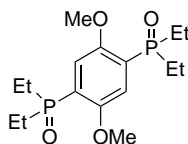
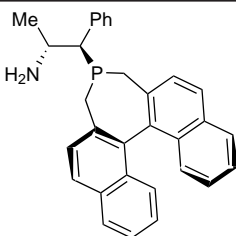
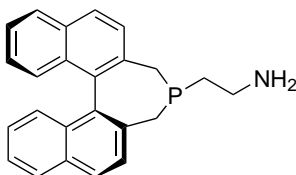
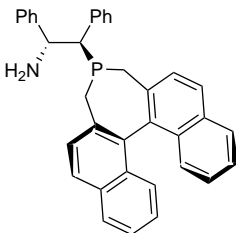

PHOSPHORUS (Compounds)

93-1571 HAZ	Difluorophosphoric acid hemihydrate, tech. gr. (13779-41-4) HPO ₂ F ₂ ·0.5H ₂ O; FW: 101.98 (110.99); yellow fuming liq.; m.p. -96.5°; b.p. 115.9°; d. 1.583 (25°)	250g 1kg
26-1170	(S)-(+)-1-[(R)-2-(Di-2-furylphosphino)ferrocenyl]ethylidene-3,5-xylylphosphine, min. 97% (649559-66-0) See page 102	
15-7137	(1R,2R)-2-[(4S,11bR)-3,5-Dihydro-4H-dinaphtho[2,1-c:1',2'-e]phosphepin-4-yl]-1,2-diphenylethanamine, min. 97% (1469882-57-2) C ₃₆ H ₃₀ NP; FW: 507.60; white solid <i>air sensitive</i> Note: Sold under license from Kanata for research purposes only. WO 2008148202.	100mg 500mg
15-7136	(1S,2S)-2-[(4R,11bS)-3,5-Dihydro-4H-dinaphtho[2,1-c:1',2'-e]phosphepin-4-yl]-1,2-diphenylethanamine, min. 97% (1092064-02-2) C ₃₆ H ₃₀ NP; FW: 507.60; white solid <i>air sensitive</i> Note: Sold under license from Kanata for research purposes only. WO 2008148202.	100mg 500mg
15-7134	2-[(11bS)-3,5-Dihydro-4H-dinaphtho[2,1-c:1',2'-e]phosphepin-4-yl]ethyl]amine, min. 97% (1053659-64-5) C ₂₄ H ₂₂ NP; FW: 355.41; pale yellow solid <i>air sensitive</i> Note: Sold under license from Kanata for research purposes only. WO2008148202.	100mg 500mg
15-7141	(1R,2R)-2-[(4S,11bR)-3,5-Dihydro-4H-dinaphtho[2,1-c:1',2'-e]phosphepin-4-yl]-1-phenylpropan-2-amine, min. 97% C ₃₁ H ₂₈ NP; FW: 445.53; white solid <i>air sensitive</i> Note: Sold under license from Kanata for research purposes only. WO 2008148202.	100mg 500mg
15-7140	(1S,2S)-2-[(4R,11bS)-3,5-Dihydro-4H-dinaphtho[2,1-c:1',2'-e]phosphepin-4-yl]-1-phenylpropan-2-amine, min. 97% (1092064-04-4) C ₃₁ H ₂₈ NP; FW: 445.53; white solid <i>air sensitive</i> Note: Sold under license from Kanata for research purposes only. WO 2008148202.	100mg 500mg
15-1372 NEW	(2,5-Dimethoxy-1,4-phenylene)bis(diethylphosphine oxide), 99+% Redox shuttle ANL-RS51 (1802015-49-1) C ₁₆ H ₂₈ O ₄ P ₂ ; FW: 346.34; white solid <i>air sensitive, moisture sensitive</i> Note: U.S. Patent: 14/171,556. For detailed technical note visit strem.com .	500mg 2g
15-1365 NEW	(2,5-Dimethoxy-1,4-phenylene)bis(di-i-propylphosphine oxide), 99+% Redox shuttle ANL-RS5 (1426397-81-0) C ₂₀ H ₃₆ O ₄ P ₂ ; FW: 402.45; white powder. <i>air sensitive, moisture sensitive</i> Note: U.S. Patent: 14/171,556. For detailed technical note visit strem.com .	250mg 1g

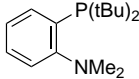
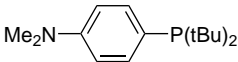
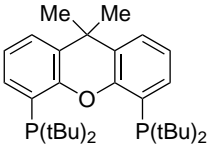
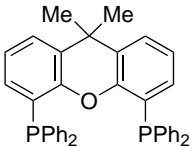

PHOSPHORUS (Compounds)

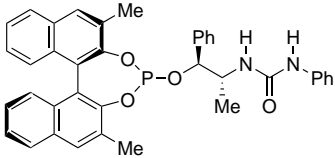
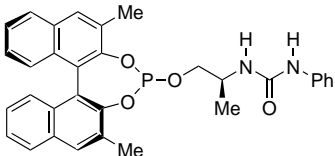
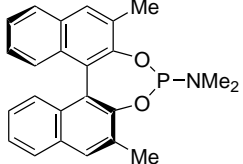
15-1260 NEW	[2-(N,N-Dimethylamino)phenyl]di-t-butylphosphine, min. 95% (415941-58-1) C ₁₆ H ₂₈ NP; FW: 265.37; white to light-brown xtl.; m.p. 50-53° Note: Ligand used in the copper-catalyzed coupling of arylboronate esters with aryl and heteroaryl halides. For detailed technical note visit strem.com .		1g 5g
15-1248	[4-(N,N-Dimethylamino)phenyl]di-t-butylphosphine, min. 95% amphos (932710-63-9) C ₁₆ H ₂₈ NP; FW: 265.37; white to light-brown xtl.; m.p. 57-61° For detailed technical note visit strem.com .		1g 5g 25g
15-1241	9,9-Dimethyl-4,5-bis(di-t-butylphosphino)xanthene, min. 97% t-Bu-XANTPHOS (856405-77-1) C ₃₁ H ₄₈ OP ₂ ; FW: 498.66; white to light yellow powdr. For detailed technical note visit strem.com .		500mg 2g
15-1242	9,9-Dimethyl-4,5-bis(diphenylphosphino)xanthene, min. 98% XANTPHOS (161265-03-8) C ₃₉ H ₃₂ OP ₂ ; FW: 578.63; light-yellow xtl.; m.p. 221-222° For detailed technical note visit strem.com .		1g 5g 25g 100g
15-1250 amp HAZ 	Dimethylchlorophosphine, min. 97% (811-62-1) (CH ₃) ₂ PCl; FW: 96.50; colorless to pale yellow liq.; b.p. 76-77°; f.p. -1°F; d. 1.22 <i>moisture sensitive, pyrophoric</i>		1g 5g
15-2206	1-((1S,2R)-1-[(11bR)-2,6-Dimethyldinaphtho[2,1-d:1',2'-f][1,3,2]dioxaphosphepin-4-yloxy]-1-phenylpropan-2-yl)-3-phenylurea, min. 97% (1858223-86-5) C ₃₈ H ₃₃ N ₃ O ₂ P; FW: 612.65; white powdr. <i>moisture sensitive, (store cold)</i> Note: Sold under license from InCaT for research purposes only. WO2004/103559. UREAPhos and METAMORPhos Ligand Kit component. For detailed technical note visit strem.com .		50mg 250mg
15-2204	1-((2S)-1-[(11bS)-2,6-Dimethyldinaphtho[2,1-d:1',2'-f][1,3,2]dioxaphosphepin-4-yloxy]propan-2-yl)-3-phenylurea, min. 97% (1357562-63-0) C ₃₈ H ₂₉ N ₃ O ₂ P; FW: 536.56; white powdr. <i>moisture sensitive, (store cold)</i> Note: Sold under license from InCaT for research purposes only. WO2004/103559. UREAPhos and METAMORPhos Ligand Kit component. For detailed technical note visit strem.com .		50mg 250mg
15-1255	(S)-(+)-(2,6-Dimethyl-3,5-dioxa-4-phosphacyclohepta[2,1-a;3,4-a']dinaphthalen-4-yl)dimethylamine, min. 98% (185449-86-9) C ₂₄ H ₂₂ NO ₂ P; FW: 387.41; off-white powdr.; m.p. 228-229° <i>moisture sensitive</i> Note: Sold in collaboration with DSM for research purposes only. Patent WO 0204466. DSM's MonoPhos™ Ligand Kit component. For detailed technical note visit strem.com .		100mg 500mg

PHOSPHORUS (Compounds)

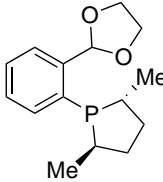
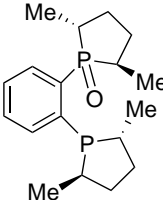
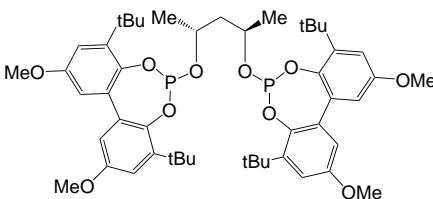
15-1280	Dimethyldiphenylphosphonium iodide, 98% (1017-88-5) (CH ₃) ₂ (C ₆ H ₅) ₂ P ⁺ I ⁻ ; FW: 342.16; white xtl. <i>hygroscopic</i>	5g 25g
93-1523	Dimethylmethylphosphonate, 97% (756-79-6) (CH ₃ O) ₂ P(O)(CH ₃); FW: 124.08; colorless liq.; b.p. 92-97°/50 mm; f.p. 156°F; d. 1.160	100g 500g 2kg
15-1400 amp HAZ	Dimethylphenylphosphine, 99% (672-66-2) (CH ₃) ₂ (C ₆ H ₅)P; FW: 138.15; colorless liq.; b.p. 75-79°/12 mm; f.p. 122°F; d. 0.967 <i>air sensitive</i>	2g 10g
15-1425	Dimethylphosphine oxide, min. 97% (7211-39-4) C ₂ H ₇ OP; FW: 78.05; white solid <i>air sensitive</i>	500mg 2g
15-7335	2-[2-[(2R,5R)-2,5-Dimethyl-1-phospholano]phenyl]1,3-dioxolane, min. 97% (1044256-04-3) C ₁₅ H ₂₁ O ₂ P; FW: 264.30; pale yellow to colorless liq. <i>air sensitive</i> Note: Sold under license from Kanata for research purposes only.	100mg 500mg
		
15-7336	2-[2-[(2S,5S)-2,5-Dimethyl-1-phospholano]phenyl]1,3-dioxolane, min. 97% (695816-47-8) C ₁₅ H ₂₁ O ₂ P; FW: 264.30; pale yellow to colorless liq. <i>air sensitive</i> Note: Sold under license from Kanata for research purposes only.	100mg 500mg
15-7360	[1-(2R,5R)-2,5-Dimethylphospholanyl]-[2-(2R,5R)-2,5-dimethylphospholanyl-1-oxide]benzene, min. 97% (638132-66-8) C ₁₈ H ₂₈ OP ₂ ; FW: 322.36; white solid <i>air sensitive</i> Note: Sold under license from Kanata for research purposes only.	100mg 500mg
		
15-7361	[1-(2S,5S)-2,5-Dimethylphospholanyl]-[2-(2S,5S)-2,5-dimethylphospholanyl-1-oxide]benzene, min. 97% (1380079-15-1) C ₁₈ H ₂₈ OP ₂ ; FW: 322.36; white solid <i>air sensitive</i> Note: Sold under license from Kanata for research purposes only.	100mg 500mg
15-1455	(+)-6,6'-[[[(1R,3R)-1,3-Dimethyl-1,3-propanediyl]bis(oxy)]bis[4,8-bis(t-butyl)-2,10-dimethoxy-benzo[d,f][1,3,2]dioxaphosphepin], min. 95% (R,R)-Chiraphite (149646-83-3) C ₄₈ H ₆₆ O ₁₀ P ₂ ; FW: 876.99; off-white pwd. <i>air sensitive, moisture sensitive</i> Note: Sold in collaboration with Chirotech for research purposes only. US Patent No. 5,491,266. For detailed technical note visit strem.com .	100mg 500mg
		
15-1456	(-)-6,6'-[[[(1S,3S)-1,3-Dimethyl-1,3-propanediyl]bis(oxy)]bis[4,8-bis(t-butyl)-2,10-dimethoxy-benzo[d,f][1,3,2]dioxaphosphepin], min. 95% (S,S)-Chiraphite (852042-07-0) C ₄₈ H ₆₆ O ₁₀ P ₂ ; FW: 876.99; off-white pwd. <i>air sensitive, moisture sensitive</i> Note: Sold in collaboration with Chirotech for research purposes only. US Patent No. 5,491,266.	100mg 500mg

PHOSPHORUS (Compounds)

15-1505	<p>(3aR,8aR)-(-)-[2,2-Dimethyl-4,4,8,8-tetra-phenyl-tetrahydro-[1,3]dioxolo[4,5-e][1,3,2]dioxaphosphepin-6-yl]dimethylamine, min. 98% (213843-90-4) C₃₃H₃₄NO₂P; FW: 539.60; white powdr.; m.p. 218-221° <i>moisture sensitive</i> Note: Sold in collaboration with DSM for research purposes only. Patent WO 0204466. DSM's Mono-Phos™ Ligand Kit component. For detailed technical note visit strem.com.</p>		100mg 500mg
15-7203	<p>(2R)-1-(11bR)-(Dinaphtho[2,1-d:1',2'-f][1,3,2]dioxaphosphepin-4-yl)-2-methyl-1,2,3,4-tetrahydroquinoline, 98% (1186392-43-7) C₃₀H₂₄NO₂P; FW: 461.49; yellow powdr. <i>moisture sensitive</i> Note: Sold in collaboration with SIOC for research purposes only. Patent ZL200910048438.6. For detailed technical note visit strem.com.</p>		250mg 1g
15-7204	<p>(2R)-1-(11bS)-(Dinaphtho[2,1-d:1',2'-f][1,3,2]dioxaphosphepin-4-yl)-2-methyl-1,2,3,4-tetrahydroquinoline, 98% (1186392-32-4) C₃₀H₂₄NO₂P; FW: 461.49; white to off-white powdr. <i>moisture sensitive</i> Note: Sold in collaboration with SIOC for research purposes only. Patent ZL200910048438.6. For detailed technical note visit strem.com.</p>		250mg 1g
15-2202	<p>1-((1R,2S)-1-((11bR)-Dinaphtho[2,1-d:1',2'-f][1,3,2]dioxaphosphepin-4-yloxy)-1-phenylpropan-2-yl)-3-phenylurea, min. 97% (1198080-55-5) C₃₆H₂₉N₂O₄P; FW: 584.60; white powdr. <i>moisture sensitive, (store cold)</i> Note: Sold under license from InCatT for research purposes only. WO2004/103559. UREAPhos and METAMORPhos Ligand Kit component. For detailed technical note visit strem.com.</p>		50mg 250mg
15-2200	<p>1-((2R)-1-((11bR)-Dinaphtho[2,1-d:1',2'-f][1,3,2]dioxaphosphepin-4-yloxy)propan-2-yl)-3-phenylurea, min. 97% UREAPhos (1198080-53-3) C₃₀H₂₅N₂O₄P; FW: 508.50; white powdr. <i>moisture sensitive, (store cold)</i> Note: Sold under license from InCatT for research purposes only. WO2009/065856. UREAPhos and METAMORPhos Ligand Kit component. For detailed technical note visit strem.com.</p>		50mg 250mg
15-2201	<p>1-((2S)-1-((11bR)-Dinaphtho[2,1-d:1',2'-f][1,3,2]dioxaphosphepin-4-yloxy)propan-2-yl)-3-phenylurea, min. 97% (1357562-63-0) C₃₀H₂₅N₂O₄P; FW: 508.50; white powdr. <i>moisture sensitive, (store cold)</i> Note: Sold under license from InCatT for research purposes only. WO2004/103559, WO2009/065853. UREAPhos and METAMORPhos Ligand Kit component. For detailed technical note visit strem.com.</p>		50mg 250mg

PHOSPHORUS (Compounds)

15-2228	<p>N-[(11bS)-Dinaphtho[2,1-d:1',2'-f][1,3,2]dioxaphosphepin-4-yl]-1,1,1-trifluoromethanesulfonamide triethylamine adduct, min. 97% METAMORPhos (1493790-73-0) $C_{27}H_{13}F_3NO_4PS \cdot (C_2H_5)_3N$; FW: 564.56; white powdr. <i>moisture sensitive, (store cold)</i> Note: Sold under license from InCaT for research purposes only. WO2009/065856. UREAPhos and METAMORPhos Ligand Kit component. For detailed technical note visit strem.com.</p>		50mg 250mg
15-1460 HAZ 	<p>Di-2-norbornylphosphine, min. 98% (mixture of endo and exo isomers) (148432-44-4) $(C_7H_{11})_2PH$; FW: 222.31; colorless liq.; d. 0.88 <i>pyrophoric</i></p>		1g 5g
15-1461 HAZ	<p>Di-2-norbornylphosphine, min. 98% (mixture of endo and exo isomers) (10 wt% in hexanes) (148432-44-4) $(C_7H_{11})_2PH$; FW: 222.31; colorless liq. <i>air sensitive</i></p>		10g 50g
15-1510	<p>(S)-(+)-(3,5-Dioxa-4-phospha-cyclohepta[2,1-a;3,4-a']dinaphthalen-4-yl)benzyl(methyl)amine, 99% (490023-37-5) $C_{28}H_{22}NO_2P$; FW: 435.45; white powdr.; m.p. 155° <i>moisture sensitive</i> Note: Sold in collaboration with DSM for research purposes only. Patent WO 0204466. DSM's MonoPhos™ Ligand Kit component. For detailed technical note visit strem.com.</p>		100mg 500mg
15-1521	<p>(S)-(+)-(3,5-Dioxa-4-phospha-cyclohepta[2,1-a;3,4-a']dinaphthalen-4-yl)bis[(1S)-1-phenylethyl]amine, min. 95% (380230-02-4) $C_{36}H_{30}NO_2P$; FW: 539.60; off-white powdr.; m.p. 88-89° <i>moisture sensitive</i> Note: Sold in collaboration with DSM for research purposes only. Patent WO 0204466. DSM's MonoPhos™ Ligand Kit component. For detailed technical note visit strem.com.</p>		100mg 500mg
15-1520	<p>(S)-(+)-(3,5-Dioxa-4-phospha-cyclohepta[2,1-a;3,4-a']dinaphthalen-4-yl)bis[(1R)-1-phenylethyl]amine, dichloromethane adduct, min. 95% (415918-91-1) $C_{36}H_{30}NO_2P$; FW: 539.60; white powdr.; m.p. 102-103° <i>moisture sensitive</i> Note: Sold in collaboration with DSM for research purposes only. Patent WO 0204466. DSM's MonoPhos™ Ligand Kit component. For detailed technical note visit strem.com.</p>		100mg 500mg
15-1227 	<p>(S)-(+)-(3,5-Dioxa-4-phosphacyclohepta[2,1-a;3,4-a']dinaphthalen-4-yl)-5H-dibenz[b,f]azepine, min. 97% (942939-38-0) $C_{34}H_{22}NO_2P$; FW: 507.52; yellow solid <i>air sensitive, moisture sensitive</i> For detailed technical note visit strem.com.</p>		100mg 500mg

PHOSPHORUS (Compounds)

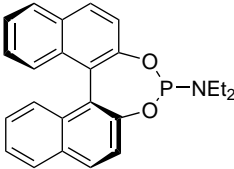
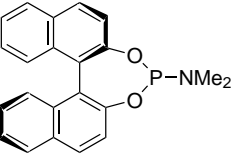
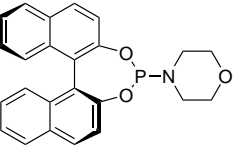
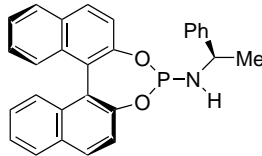
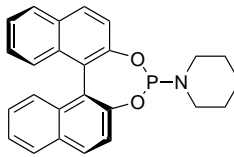
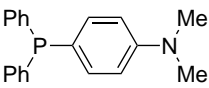
15-1231	(S)(+)-(3,5-Dioxa-4-phospha-cyclohepta[2,1-a;3,4-a']dinaphthalen-4-yl)diethylamine, min. 97% (252288-04-3) C ₂₄ H ₂₂ NO ₂ P; FW: 387.41; white powdr. <i>moisture sensitive</i> Note: Sold in collaboration with DSM for research purposes only. Patent WO 0204466. DSM's MonoPhos™ Ligand Kit component. For detailed technical note visit strem.com .		250mg 1g
15-1232	(R)(-)-(3,5-Dioxa-4-phospha-cyclohepta[2,1-a;3,4-a']dinaphthalen-4-yl)dimethylamine, min. 97% (R)-MONOPHOS (157488-65-8) C ₂₂ H ₁₈ NO ₂ P; FW: 359.36; white xtl.; m.p. 190° <i>air sensitive</i> Note: Sold in collaboration with DSM for research purposes only. Patent no. WO02 04466. DSM's MonoPhos™ Ligand Kit component. For detailed technical note visit strem.com .		250mg 1g
15-1233	(S)(+)-(3,5-Dioxa-4-phospha-cyclohepta[2,1-a;3,4-a']dinaphthalen-4-yl)dime-thylamine, min. 97% (S)-MONOPHOS (185449-80-3) C ₂₂ H ₁₈ NO ₂ P; FW: 359.36; white xtl.; m.p. 190° <i>moisture sensitive</i> Note: Sold in collaboration with DSM for research purposes only. Patent no. WO02 04466. DSM's MonoPhos™ Ligand Kit component. For detailed technical note visit strem.com .		250mg 1g
15-1235	(S)(+)-(3,5-Dioxa-4-phospha-cyclohepta[2,1-a;3,4-a']dinaphthalen-4-yl)morpholine, min. 97% (S)-MorfPhos (185449-81-4) C ₂₄ H ₂₀ NO ₃ P; FW: 401.39; white powdr. <i>moisture sensitive</i> Note: Sold in collaboration with DSM for research purposes only. Patent WO 0204466. DSM's MonoPhos™ Ligand Kit component. For detailed technical note visit strem.com .		100mg 500mg
15-1525	(S)(+)-(3,5-Dioxa-4-phospha-cyclohepta[2,1-a;3,4-a']dinaphthalen-4-yl)[(1R)-1-phenylethyl] amine, min. 95% (422509-53-3) C ₂₈ H ₂₂ NO ₂ P; FW: 435.45; white powdr.; m.p. 212-213° <i>moisture sensitive</i> Note: Sold in collaboration with DSM for research purposes only. Patent WO 0204466. DSM's MonoPhos™ Ligand Kit component. For detailed technical note visit strem.com .		100mg 500mg
15-1234	(S)(+)-(3,5-Dioxa-4-phospha-cyclohepta[2,1-a;3,4-a']dinaphthalen-4-yl)piperidine, min. 97% (S)-PipPhos (284472-79-3) C ₂₅ H ₂₂ NO ₂ P; FW: 399.42; white powdr. <i>moisture sensitive</i> Note: Sold in collaboration with DSM for research purposes only. Patent WO 0204466. DSM's MonoPhos™ Ligand Kit component. For detailed technical note visit strem.com .		100mg 500mg 2g
15-1551	Diphenylchlorophosphine, min. 95% (1079-66-9) HAZ (C ₆ H ₅) ₂ PCl; FW: 220.64; yellow liq.; b.p. 100-102°/1mm; f.p. >230°F; d. 1.19 <i>air sensitive, moisture sensitive</i>		50g 250g 1kg
15-1549	Diphenylchlorophosphine, 98% (1079-66-9) HAZ C ₁₂ H ₁₀ ClP; FW: 220.64; yellow liq.; b.p. 100-102°/1 mmm; f.p. >230°F; d. 1.19 <i>moisture sensitive</i>		25g 100g 500g
15-1380	Diphenyl[4-(N,N-dimethylamino)phenyl]phosphine, min. 95% (739-58-2) NEW C ₂₀ H ₂₀ NP; FW: 305.35; white solid; m.p. 151-154° <i>air sensitive</i>		1g 5g

PHOSPHORUS (Compounds)

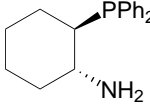
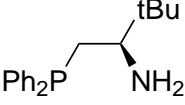
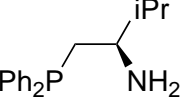
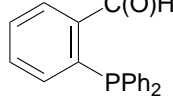
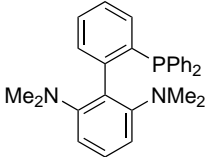
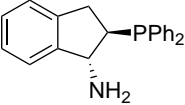
15-1700 amp HAZ 	Diphenylphosphine, 99% (829-85-6) (C ₆ H ₅) ₂ P _H ; FW: 186.20; colorless liq.; b.p. 116-119°/2.6 mm; d. 1.07 <i>pyrophoric</i>	10g 50g 250g
15-1702 HAZ	Diphenylphosphine, 99% (10 wt% in hexanes) (829-85-6) (C ₆ H ₅) ₂ P _H ; FW: 186.20; colorless liq.; d. 0.68 <i>air sensitive</i>	100g 500g
15-1740 HAZ	Diphenylphosphinic chloride, 98% (1499-21-4) (C ₆ H ₅) ₂ P(O)Cl; FW: 236.64; colorless to pale yellow liq.; b.p. 138-139°/0.15 mm; f.p. 79°F; d. 1.240 <i>moisture sensitive</i>	5g 25g 100g
15-7153	(1R,2R)-2-(Diphenylphosphino)-1-aminocyclohexane, min. 97% (452304-59-5) C ₁₈ H ₂₂ NP; FW: 283.35; white solid <i>air sensitive</i>	 100mg 500mg
15-7154	(1S,2S)-2-(Diphenylphosphino)-1-aminocyclohexane, min. 97% (452304-63-1) C ₁₈ H ₂₂ NP; FW: 283.35; white solid; m.p. 51-56° <i>air sensitive</i>	100mg 500mg
15-7253 HAZ	(R)-1-(Diphenylphosphino)-2-amino-3,3-dimethylbutane, min. 97% (10wt% in hexanes) (1366384-12-4) C ₁₈ H ₂₄ NP; FW: 285.36; colorless liq. <i>air sensitive</i>	 1g 5g
15-7255 HAZ	(S)-1-(Diphenylphosphino)-2-amino-3,3-dimethylbutane, min. 97% (10wt% in hexanes) (286454-86-2) C ₁₈ H ₂₄ NP; FW: 285.36; colorless liq. <i>air sensitive</i>	1g 5g
15-7146	(R)-1-(Diphenylphosphino)-2-amino-3-methylbutane, min. 97% (1400149-69-0) C ₁₇ H ₂₂ NP; FW: 271.34; colorless oil <i>air sensitive</i>	 100mg 500mg
15-7147	(S)-1-(Diphenylphosphino)-2-amino-3-methylbutane, min. 97% (146476-37-1) C ₁₇ H ₂₂ NP; FW: 271.34; colorless oil <i>air sensitive</i>	100mg 500mg
15-0120	2-(Diphenylphosphino)benzaldehyde, min. 97% (50777-76-9) (C ₆ H ₅) ₂ P(C ₆ H ₅ COH); FW: 290.30; white to yellow pwdr.; m.p. 112-115°	 250mg 1g
15-0133	2-(Diphenylphosphino)benzoic acid, min. 97% (17261-28-8) (C ₆ H ₅) ₂ P(C ₆ H ₅ COOH); FW: 306.30; white to yellow solid; m.p. 174-181°	1g 5g
15-1125 NEW	2-Diphenylphosphino-2',6'-bis(dimethylamino)-1,1'-biphenyl, min. 98% PhCPhos (1447963-71-4) C ₂₈ H ₂₉ N ₂ P; FW: 424.52; tan solid Note: Patents: US 6,395,916, US 6,307,087 For detailed technical note visit strem.com .	 100mg 500mg
15-7110 HAZ	(1R,2R)-2-(Diphenylphosphino)-2,3-dihydro-1H-inden-1-amine, min. 97% (10wt% in THF) (1091606-70-0) C ₂₁ H ₂₀ NP; FW: 317.36; colorless to pale yellow liq. <i>air sensitive</i> Note: Sold under license from Kanata for research purposes only. WO2008148202.	 1g 5g

PHOSPHORUS (Compounds)

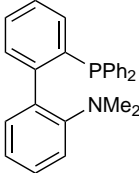
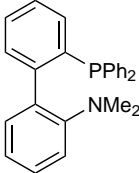
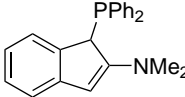
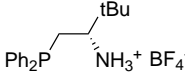
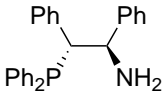
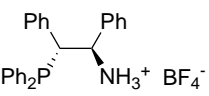
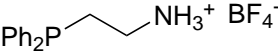
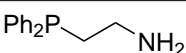
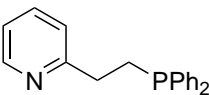
15-7111 HAZ	(1S,2S)-2-(Diphenylphosphino)-2,3-dihydro-1H-inden-1-amine, min. 97% (10wt% in THF) (1091606-69-7) C ₂₃ H ₂₀ NP; FW: 317.36; colorless to pale yellow liq. <i>air sensitive</i> Note: Sold under license from Kanata for research purposes only. WO2008148202.		1g 5g
15-1745	2-Diphenylphosphino-2'-(N,N-dimethylamino))-1,1'-biphenyl, 98% PhDavePhos (240417-00-9) C ₂₆ H ₂₄ NP; FW: 381.46; white powdr. Note: Buchwald Biaryl Phosphine Ligand Master Kit component.. Buchwald Biaryl Phosphine Ligand Mini Kit 2 component.. Patents: US 6,395,916, US 6,307,087. For detailed technical note visit strem.com .		500mg 2g 10g
15-1748	1-Diphenylphosphino-2-(N,N-dimethylamino)-1H-indene, 99% (contains vinylic isomer) (628323-64-8) C ₂₃ H ₂₂ NP; FW: 343.40; off-white xtl. (store cold) For detailed technical note visit strem.com .		250mg 1g
15-7194	(S)-1-(Diphenylphosphino)-3,3-dimethylbutan-2-aminium tetrafluoroborate, min. 97% C ₁₈ H ₂₅ BF ₄ NP; FW: 373.18; white solid <i>air sensitive</i> Note: Sold under license from Kanata for research purposes only. PCT/CA2009/001412.		100mg 500mg
15-7102	(1R,2R)-2-(Diphenylphosphino)-1,2-diphenylethylamine, min. 97% (1091606-68-6) C ₂₆ H ₂₄ NP; FW: 318.45; white solid <i>air sensitive</i> Note: Sold under license from Kanata for research purposes only. WO2008148202.		100mg 500mg
15-7103	(1S,2S)-2-(Diphenylphosphino)-1,2-diphenylethylamine, min. 97% (1091606-67-5) C ₂₆ H ₂₄ NP; FW: 318.45; white solid <i>air sensitive</i> Note: Sold under license from Kanata for research purposes only. WO2008148202.		100mg 500mg
15-7156	(1R,2R)-2-(Diphenylphosphino)-1,2-diphenylethylammonium tetrafluoroborate, min. 97% C ₂₆ H ₂₅ BF ₄ NP; FW: 469.26; white solid <i>air sensitive</i> Note: Sold under license from Kanata for research purposes only. PCT/CA2009/001412.		100mg 500mg
15-7174	2-(Diphenylphosphino)ethan ammonium tetrafluoroborate, min. 97% (1222630-32-1) C ₁₄ H ₁₇ BF ₄ NP; FW: 317.06; white to beige solid <i>air sensitive</i> Note: Sold under license from Kanata for research purposes only. PCT/CA2009/001412.		500mg 2g
15-1762	2-(Diphenylphosphino)ethylamine, min. 95% (4848-43-5) (C ₆ H ₅) ₂ PCH ₂ CH ₂ NH ₂ ; FW: 229.26; colorless to yellow liq. <i>air sensitive</i> For detailed technical note visit strem.com .		1g 5g
15-1765	2-[2-(Diphenylphosphino)ethyl]pyridine, min. 97% (10150-27-3) C ₁₈ H ₁₈ NP; FW: 291.33; white powdr. <i>air sensitive</i> For detailed technical note visit strem.com .		100mg 500mg
26-1153	(S)-(-)-[(S)-2-Diphenylphosphinoferrocenyl] [2-bis(3,5-dimethyl-4-methoxyphenyl)phosphinophenyl]methanol, min. 97% (851308-47-9) See page 103		

PHOSPHORUS (Compounds)

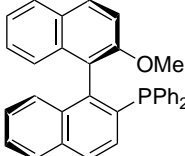
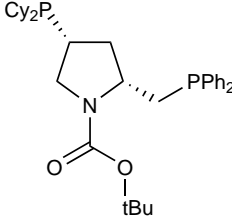
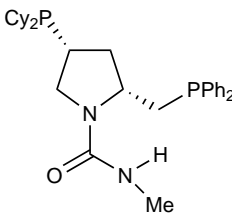
26-1160	(S)-(-)-[(S)-2-Diphenylphosphinofero-cenyl] [2-diphenylphosphinophenyl] methanol, min. 97% (851308-43-5) See page 103		
26-1155	(S)-(-)-[(S)-2-Diphenylphosphinofero-cenyl] (N,N-dimethylamino) 2-diphenylphosphinophenyl)methane, min. 97% TANIAPHOS (850444-36-9) See page 103		
26-1425	(R)-1-(S)-2-Diphenylphosphino)ferrocenylethylamine, min. 97% (607389-84-4) See page 103		
26-1426	(S)-1-(R)-2-Diphenylphosphino)ferrocenylethylamine, min. 97% See page 103		
26-1200	(R)-(-)-1-[(S)-2-(Diphenylphosphino)ferrocenyl]ethyl-di-t-butylphosphine, min. 97% (155830-69-6) See page 103		
26-1201	(S)-(+)-1-[(R)-2-(Diphenylphosphino)ferrocenyl]ethyl-di-t-butylphosphine, min. 97% (277306-29-3) See page 103		
26-1210	(R)-(-)-1-[(S)-2-(Diphenylphosphino) ferrocenyl]ethyl-dicyclohexylphosphine ethanol adduct, min. 97% (R)-(S)-JOSIPHOS (155806-35-2) See page 104		
26-1211	(S)-(+)-1-[(R)-2-(Diphenylphosphino)ferrocenyl]ethyl-dicyclohexylphosphine ethanol adduct, min. 97% (S)-(R)-JOSIPHOS (162291-02-3) See page 104		
26-1255	(R)-(-)-1-[(S)-2-(Diphenylphosphino) ferrocenyl]ethyl-di-3,5-xylylphosphine, min. 97% (184095-69-0) See page 104		
15-1775	(R)-(+)-2-(Diphenylphosphino)-2'-methoxy-1,1'-binaphthyl, 99% (R)-MOP (145964-33-6) C ₃₃ H ₂₅ OP; FW: 468.53; white powdr.; m.p. 177-179° <i>air sensitive</i> Note: Sold in collaboration with Takasago for research purposes only. Patents US 5231202, EP 0503884, JP 05-017491. For detailed technical note visit strem.com .		100mg 500mg
15-1776	(S)-(-)-2-(Diphenylphosphino)-2'-methoxy-1,1'-binaphthyl, 99% (S)-MOP (134484-36-9) C ₃₃ H ₂₅ OP; FW: 468.53; white powdr.; m.p. 175-179° <i>air sensitive</i> Note: Sold in collaboration with Takasago for research purposes only. Patents US 5231202, EP 0503884, JP 05-017491.		100mg 500mg
15-7220	(2R,4R)-(+)-2-(Diphenylphosphinomethyl)-4-(dicyclohexylphosphino)-N-(t-butoxycarbonyl) pyrrolidine, min. 97% (R,R-BCPM) (114751-47-2) C ₃₄ H ₄₉ NO ₂ P ₂ ; FW: 565.71; white powdr. <i>air sensitive</i>		50mg 250mg
15-7224	(2R,4R)-(+)-2-(Diphenylphosphinomethyl)-4-(dicyclohexylphosphino)-N-methyl-1-pyrrolidinecarboxamide, min. 95% (R,R-MCCPM) (122709-72-2) C ₃₁ H ₄₄ N ₂ OP ₂ ; FW: 522.64; white powdr. <i>air sensitive</i>		50mg 250mg

PHOSPHORUS (Compounds)

15-7225	(2S,4S)-(-)-2-(Diphenylphosphinomethyl)-4-(dicyclohexylphosphino)-N-methyl-1-pyrrolidinecarboxamide, min. 97% (S,S-MCCPM) (112521-97-8) C ₃₁ H ₄₄ N ₂ OP ₂ ; FW: 522.64; white powdr. <i>air sensitive</i>		50mg 250mg
15-7211	(2S,4S)-(-)-2-(Diphenylphosphinomethyl)-4-(diphenylphosphino) pyrrolidine, min. 97% (S,S-PPM) (61478-29-3) C ₂₉ H ₂₉ NP ₂ ; FW: 453.50; white powdr. <i>air sensitive</i>		100mg 500mg
15-7210	(2R,4R)-(+)-2-(Diphenylphosphinomethyl)-4-(diphenylphosphino) pyrrolidine, min. 97% (R,R-PPM) (77450-05-6) C ₂₉ H ₂₉ NP ₂ ; FW: 453.50; white powdr. <i>air sensitive</i>		100mg 500mg
15-7216	(2R,4R)-(+)-2-(Diphenylphosphinomethyl)-4-(diphenylphosphino)-N-(t-butoxycarbonyl)pyrrolidine, min. 97% (R,R-BPPM) (72598-03-9) C ₃₄ H ₃₇ NO ₂ P ₂ ; FW: 553.61; white powdr. <i>air sensitive</i>		100mg 500mg
15-7217	(2S,4S)-(-)-2-(Diphenylphosphinomethyl)-4-(diphenylphosphino)-N-(t-butoxycarbonyl)pyrrolidine, min. 97% (S,S-BPPM) (61478-28-2) C ₃₄ H ₄₉ NO ₂ P ₂ ; FW: 565.71; white powdr. <i>air sensitive</i>		100mg 500mg
15-1804	2-Diphenylphosphino-6-methylpyridine, 98% (132682-77-0) C ₁₈ H ₁₆ NP; FW: 277.30; white to off-white xtl.; m.p. 81-83°		500mg 2g
15-7116	(S)-2-[(Diphenylphosphino)methyl]pyrrolidine, min. 97% (60261-46-3) C ₁₇ H ₂₀ NP; FW: 269.32; colorless to pale yellow liq. <i>air sensitive</i>		250mg 1g
15-7115 HAZ	(R)-2-[(Diphenylphosphino)methyl]pyrrolidine, min. 97% (10 wt% in tetrahydrofuran) (428514-91-4) C ₁₇ H ₂₀ NP; FW: 269.32; colorless liq. <i>air sensitive</i>		2g 10g
15-7165	(R)-2-[(Diphenylphosphino)methyl]pyrrolidinium tetrafluoroborate, min. 97% C ₁₇ H ₂₁ BF ₄ NP; FW: 357.13; white solid <i>air sensitive</i> Note: Sold under license from Kanata for research purposes only. PCT/CA2009/001412.		100mg 500mg
15-7166	(S)-2-[(Diphenylphosphino)methyl]pyrrolidinium tetrafluoroborate, min. 97% (1222630-36-5) C ₁₇ H ₂₁ BF ₄ NP; FW: 357.13; white solid <i>air sensitive</i> Note: Sold under license from Kanata for research purposes only. PCT/CA2009/001412.		100mg 500mg

PHOSPHORUS (Compounds)

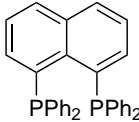
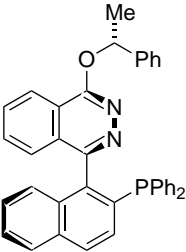
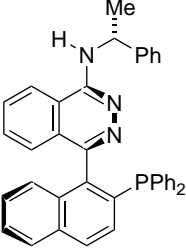
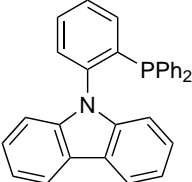
15-7123	1,8-(Diphenylphosphino)naphthalene, 99% (153725-04-3) C ₃₄ H ₂₆ P ₂ ; FW: 496.52; yellow xtl. <i>air sensitive</i>		250mg 1g
15-1782	(R)-(+)-4-[2-(Diphenylphosphino)-1-naphthalenyl]-N-[(R)-1-phenylethoxy]phthalazine, min. 97% (R,R)-O-PINAP (828927-95-3) C ₃₈ H ₂₉ N ₂ OP; FW: 560.62; colorless xtl.; m.p. 64-65° <i>air sensitive</i> Note: PINAP Ligand Kit component. For detailed technical note visit strem.com .		250mg 1g
15-1783	(S)-(-)-4-[2-(Diphenylphosphino)-1-naphthalenyl]-N-(R)-1-phenylethoxy] phthalazine, min. 97% (R,S)-O-PINAP (828927-94-2) C ₃₈ H ₂₉ N ₂ OP; FW: 560.62; colorless xtl.; m.p. 178-181° <i>air sensitive</i> Note: PINAP Ligand Kit component.		250mg 1g
Technical Note: 1. See 15-1782 (page 307)			
15-1784	(R)-(+)-4-[2-(Diphenylphosphino)-1-naphthalenyl]-N-(R)-1-phenylethyl]-1-phthalazinamine, min. 97% (R,R)-N-PINAP (828927-97-5) C ₃₈ H ₃₀ N ₃ P; FW: 559.64; colorless xtl.; m.p. 185-188° <i>air sensitive</i> Note: PINAP Ligand Kit component. For detailed technical note visit strem.com .		100mg 500mg
15-1787	(R)-(+)-4-[2-(Diphenylphosphino)-1-naphthalenyl]-N-[(S)-1-phenylethyl]-1-phthalazinamine, min. 97% (S,R)-N-PINAP (1173836-08-2) C ₃₈ H ₃₀ N ₃ P; FW: 559.64; colorless xtl.; m.p. >210° <i>air sensitive</i> Note: PINAP Ligand Kit component. For detailed technical note visit strem.com .		250mg 1g
15-1786	(S)-(-)-4-[2-(Diphenylphosphino)-1-naphthalenyl]-N-(R)-1-phenylethyl]-1-phthalazinamine, min. 97% (R,S)-N-PINAP (828927-96-4) C ₃₈ H ₃₀ N ₃ P; FW: 559.64; colorless xtl.; m.p. >210° <i>air sensitive</i> Note: PINAP Ligand Kit component.		250mg 1g
Technical Note: 1. See 15-1787 (page 307)			
15-0498	9-[2-(Diphenylphosphino)phenyl]-9H-carbazole, min. 97% Ph PhenCar-Phos (1308652-67-6) C ₃₀ H ₂₂ NP; FW: 427.48; white powdr. <i>air sensitive</i> Note: PhenCar-Phos Ligand Kit component.		250mg 1g

PHOSPHORUS (Compounds)

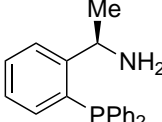
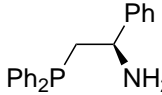
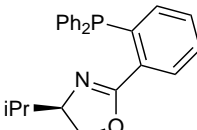
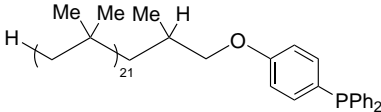
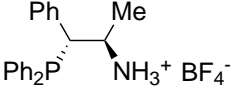
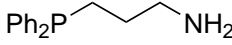
15-7118	(R)-1-[2-(Diphenylphosphino)phenyl]ethylamine, min. 97% (192057-60-6) C ₂₀ H ₂₀ NP; FW: 305.35; white solid <i>air sensitive</i>		250mg 1g
15-7119	(S)-1-[2-(Diphenylphosphino)phenyl]ethylamine, min. 97% (913196-43-7) C ₂₀ H ₂₀ NP; FW: 305.35; white solid <i>air sensitive</i>		250mg 1g
15-7121	(R)-2-(Diphenylphosphino)-1-phenylethylamine, min. 97% (141096-35-7) C ₂₀ H ₂₀ NP; FW: 381.45; white solid <i>air sensitive</i>		250mg 1g
15-7122	(S)-2-(Diphenylphosphino)-1-phenylethylamine, min. 97% (1103533-85-2) C ₂₀ H ₂₀ NP; FW: 381.45; white solid <i>air sensitive</i>		250mg 1g
26-1300	(R)-(-)-1-[(R)-2-(2'-Diphenylphosphinophenyl)ferrocenyl]ethylbis(di-3,5-trifluoromethylphenyl)phosphine, min. 97% (565184-33-0) See page 104		
26-1310	(R)-(-)-1-[(R)-2-(2'-Diphenylphosphinophenyl)ferrocenyl]ethylidicyclohexylphosphine, min. 97% (565184-29-4) See page 104		
26-1315	(R)-(+)-1-[(R)-2-(2'-Diphenylphosphinophenyl)ferrocenyl]ethyldi-phenylphosphine, min. 97% (565184-32-9) See page 104		
26-1320	(R)-(+)-1-[(R)-2-(2'-Diphenylphosphinophenyl)ferrocenyl]ethyldi(3,5-xylyl)phosphine, min. 97% (894771-25-6) See page 105		
15-1821	(R)-(+)-2-[2-(Diphenylphosphino)phenyl]-4-(1-methylethyl)-4,5-dihydrooxazole, 98% (R)-iPr-PHOX (164858-78-0) C ₂₄ H ₂₄ NOP; FW: 373.44; white powdr.; m.p. 77-80° <i>air sensitive</i> For detailed technical note visit strem.com .		50mg 250mg 1g
15-1822	(S)-(-)-2-[2-(Diphenylphosphino)phenyl]-4-(1-methylethyl)-4,5-dihydrooxazole, 98% (S)-iPr-PHOX (148461-14-7) C ₂₄ H ₂₄ NOP; FW: 373.44; white powdr.; m.p. 77-80° <i>air sensitive</i> For detailed technical note visit strem.com .		50mg 250mg 1g
15-3152 amp HAZ	4-Diphenylphosphinophenyl{2-methyl-3-[polyisobutyl(21)propyl]ether (50% in heptane/polyisobutylene)} H[CH ₂ C(Me) ₂] ₂₁ CH ₂ C(Me) HCH ₂ OC ₆ H ₄ P(Ph) ₂ ; FW: 1513; colorless liq.		1g 5g
15-7159	(1R,2R)-1-(Diphenylphosphino)-1-phenylpropan-2-ammonium tetrafluoroborate, min. 97% C ₂₁ H ₂₃ BF ₄ NP; FW: 407.19; white solid <i>air sensitive</i> Note: Sold under license from Kanata for research purposes only. PCT/CA2009/001412.		100mg 500mg
15-1767	3-(Diphenylphosphino)propylamine, min. 97% (16605-03-1) (C ₆ H ₅) ₂ P(CH ₂) ₃ NH ₂ ; FW: 243.28; colorless to pale yellow liq. <i>air sensitive</i>		500mg 2g

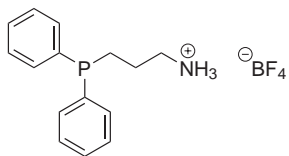
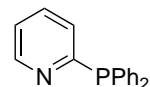
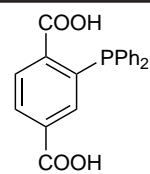
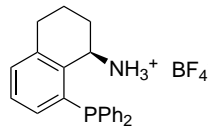
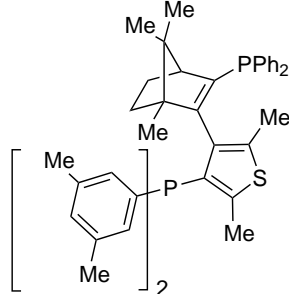
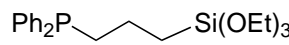
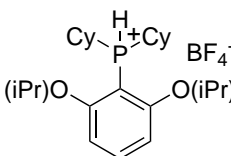

PHOSPHORUS (Compounds)

15-1769	3-(Diphenylphosphino)propylammonium tetrafluoroborate (C ₆ H ₅) ₂ PCH ₂ CH ₂ CH ₂ NH ₃ ⁺ (BF ₄); FW: 331.10; white solid <i>air sensitive, hygroscopic</i> Note: Sold under license from Kanata for research purposes only. PCT/CA2009/001412.		500mg 2g
15-1780 NEW	2-Diphenylphosphinopyridine, min. 97% (37943-90-1) C ₁₇ H ₁₄ NP; FW: 263.27; white to off-white solid For detailed technical note visit strem.com .		5g 25g
15-1710	2-(Diphenylphosphino)terephthalic acid, 98% (1537175-69-1) C ₂₀ H ₁₈ O ₄ P; FW: 350.30; white powder. Note: Ligand for MOF synthesis. Developed at the Paul Scherrer Institute, Switzerland PCT/EP2013/051405. For detailed technical note visit strem.com .		50mg 250mg
15-1789	(R)-8-(Diphenylphosphino)-1,2,3,4-tetrahydronaphthalenammonium tetrafluoroborate, min. 97% C ₂₂ H ₂₃ BF ₄ NP; FW: 419.20; white solid <i>air sensitive</i> Note: Sold under license from Kanata for research purposes only. PCT/CA2009/001412.		100mg 500mg
15-0164	(+)-4-[(1R,4S)-3-(Diphenylphosphino)-1,7,7-trimethylbicyclo[2.2.1]hept-2-en-2-yl]-2,5-dimethyl-3-thien-3-yl]bis(3,5-dimethylphenyl)phosphine, min. 95% [catASium® T3] (868851-50-7) C ₄₄ H ₄₈ P ₂ S; FW: 670.87; white powder. <i>air sensitive, light sensitive</i> Note: Sold in collaboration with Solvias for research purposes only. Patent WO2005/108407.		100mg
15-1827	Diphenyl(m-sulfonatophenyl)phosphine dihydrate sodium salt, min. 90% (63995-75-5) (C ₆ H ₅) ₂ P(C ₆ H ₄ SO ₃ Na)·2H ₂ O; FW: 364.33 (400.36); white powder. For detailed technical note visit strem.com .		250mg 1g 5g
15-1825	Diphenyl(p-sulfonatophenyl)phosphine monohydrate dimethylsulfoxide adduct, potassium salt (C ₆ H ₅) ₂ P(C ₆ H ₄ SO ₃ K)·H ₂ O·CH ₃ SOCH ₃ ; FW: 380.44 (476.59); white powder. Note: Water soluble phosphine.		1g 5g
15-1823	Diphenyl[3-(triethoxysilyl)propyl]phosphine, 98% (52090-23-0) (C ₆ H ₅) ₂ P(CH ₂) ₃ Si(OCH ₂ CH ₃) ₃ ; FW: 390.53; colorless, oily liquid. <i>air sensitive, moisture sensitive</i>		250mg 1g
Technical Note:			
1. Useful ligand for the preparation of silica-immobilized metal catalysts.			
15-6525 NEW	[2,6-Di-i-propoxyphenyl]dicyclohexylphosphonium tetrafluoroborate, 98% GorliosPhosHBF ₄ (1268824-70-9) C ₂₄ H ₄₀ BF ₄ O ₂ P; FW: 478.35; white solid; m.p. 221.6-223.2° Note: Sold under license from ZJU for research purposes only. Patents ZL200910154029.4, PCT/CN2009/001527. For detailed technical note visit strem.com .		500mg 2g

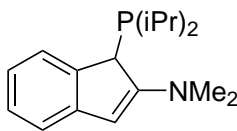
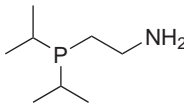
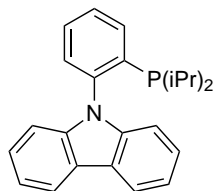
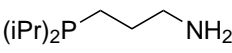
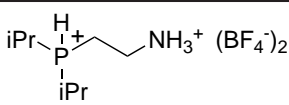
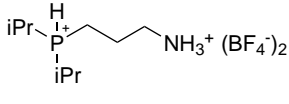

PHOSPHORUS (Compounds)

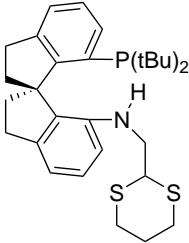
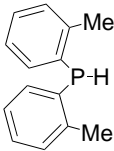
15-1800 amp HAZ	Di-<i>i</i>-propylchlorophosphine, min. 97% (40244-90-4) (C ₃ H ₇) ₂ PCl; FW: 152.60; colorless liq.; f.p. 39°F; d. 0.959 <i>air sensitive, moisture sensitive</i>		1g 5g
15-1795 HAZ 	Di-<i>i</i>-propylphosphine, 98% (20491-53-6) (C ₃ H ₇) ₂ PH; FW: 118.16; colorless liq. <i>air sensitive, pyrophoric</i>		1g 5g
15-1796 HAZ	Di-<i>i</i>-propylphosphine, 98% (10 wt% in hexanes) (20491-53-6) (C ₃ H ₇) ₂ PH; FW: 118.16; colorless liq. <i>air sensitive</i>		10g 50g
15-1802	1-Di-<i>i</i>-propylphosphino-2-(<i>N,N</i>-dimethylamino)-1<i>H</i>-indene, 99% (540492-51-1) C ₁₇ H ₂₆ NP; FW: 275.37; off-white xtl. <i>air sensitive</i> Note: Sold under license from Dalhousie for research purposes only. Provisional US patents 60/778,368 and 60/778,358. For detailed technical note visit strem.com .		250mg 1g
15-1812 HAZ	2-(Di-<i>i</i>-propylphosphino)ethylamine, min. 97% (10 wt% in THF) (1053657-14-9) (C ₃ H ₇) ₂ PCH ₂ CH ₂ NH ₂ ; FW: 161.23; pale yellow to colorless liq. <i>air sensitive, moisture sensitive</i>		5g 25g
15-0493	9-[2-(Di-<i>i</i>-propylphosphino)phenyl]- 9<i>H</i>-carbazole, min. 97% <i>i</i>-Pr PhenCar-Phos (1308652-65-4) C ₂₄ H ₂₆ NP; FW: 359.44; white powdr.; m.p. 145-149° <i>air sensitive</i> Note: PhenCar-Phos Ligand Kit component.		250mg 1g
15-1831 HAZ	3-(Di-<i>i</i>-propylphosphino)propylamine, min. 97% (10 wt% in THF) (1196147-69-9) (C ₃ H ₇) ₂ PCH ₂ CH ₂ CH ₂ NH ₂ ; FW: 175.25; colorless to pale yellow liq. <i>air sensitive</i>		5g 25g
93-1527	Di-<i>i</i>-propylphosphite, min. 98% (1809-20-7) (C ₃ H ₇ O) ₂ P(O)H; FW: 166.16; colorless liq.; b.p. 70-71°/9 mm; f.p. 156°F; d. 0.997 <i>moisture sensitive</i>		50g 250g
15-1813	2-(Di-<i>i</i>-propylphosphonium)ethylammonium bis(tetrafluoroborate), min. 97% (1222630-50-3) (C ₃ H ₇) ₂ PH ⁺ CH ₂ CH ₂ NH ₃ ⁺ (BF ₄) ₂ ; FW: 336.85; white to beige solid <i>air sensitive, hygroscopic</i> Note: Sold under license from Kanata for research purposes only. PCT/CA2009/001412.		500mg 2g
15-1832	3-(Di-<i>i</i>-propylphosphonium)propylammonium bis(tetrafluoroborate) (C ₃ H ₇) ₂ PH ⁺ CH ₂ CH ₂ CH ₂ NH ₃ ⁺ (BF ₄) ₂ ; FW: 350.88; white solid <i>air sensitive, hygroscopic</i> Note: Sold under license from Kanata for research purposes only. PCT/CA2009/001412.		500mg 2g

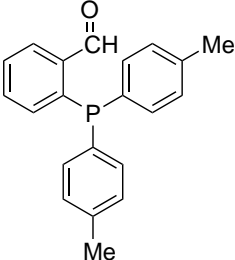
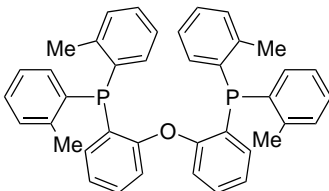
PHOSPHORUS (Compounds)

15-1638 NEW	(R)(+)-7-[N-(1,3-Dithian-2-yl)methylamino]-7'-[bis(3,5-di-t-butylphenyl)phosphino]-2,2',3,3'-tetrahydro-1,1'-spirobindane, 97+% (>99% ee) [(R)-DTB-SpiroSAP] (1809609-53-7) C ₅₉ H ₆₆ NPS ₂ ; FW: 776.17; white to off-white solid; m.p. 95-97° <i>air sensitive</i> For detailed technical note visit strem.com .		25mg 100mg
15-1639 NEW	(S)(-)-7-[N-(1,3-Dithian-2-yl)methylamino]-7'-[bis(3,5-di-t-butylphenyl)phosphino]-2,2',3,3'-tetrahydro-1,1'-spirobindane, 97+% (>99% ee) [(S)-DTB-SpiroSAP] C ₅₉ H ₆₆ NPS ₂ ; FW: 776.17; white to off-white solid; m.p. 95-97° <i>air sensitive</i>		25mg 100mg
Technical Note: 1. See 15-1638 (page 311)			
15-1815 HAZ	Di-o-tolylchlorophosphine, min. 98% (36042-94-1) (CH ₃ C ₆ H ₄) ₂ PCl; FW: 248.69; white to yellow hazy viscous liq. <i>air sensitive, moisture sensitive</i>		1g 5g
15-0435	Di-o-tolylphosphine, min. 97% (29949-64-2) (CH ₃ C ₆ H ₄) ₂ PH; FW: 214.24; colorless solid; m.p. 42-46° <i>air sensitive</i>		1g 5g
15-1820 amp HAZ 	Di-p-tolylphosphine, 99% (1017-60-3) (CH ₃ C ₆ H ₄) ₂ PH; FW: 214.25; colorless liq. <i>pyrophoric</i>		2g 10g
15-1819 HAZ	Di-p-tolylphosphine, 99% (10 wt% in hexanes) (1017-60-3) (CH ₃ C ₆ H ₄) ₂ PH; FW: 214.25; colorless liq. <i>air sensitive</i>		20g 100g
15-7344	2-(Di-p-tolylphosphino)benzaldehyde, min. 97% (1202865-03-9) C ₂₁ H ₁₉ OP; FW: 318.12; yellow solid		500mg 2g
15-7365	2,2'-(Di-o-tolylphosphino)diphenylether, min. 97% DTP-DPEphos (205497-64-9) C ₄₀ H ₃₆ OP ₂ ; FW: 594.66; white pwdr.		250mg 1g

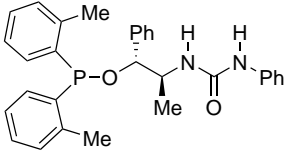
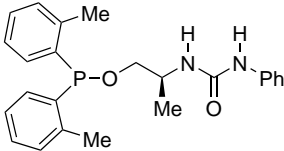
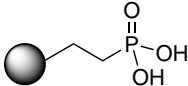
PHOSPHORUS (Compounds)

15-2214	1-[(1R,2S)-1-(Di-o-tolylphosphinoxy)-1-phenylpropan-2-yl]-3-phenylurea, min. 97% (1391410-56-2) C ₃₀ H ₃₁ N ₂ O ₂ P; FW: 482.55; white powdr. <i>moisture sensitive, (store cold)</i> Note: Sold under license from InCatT for research purposes only. WO2004/103559. UREAPhos and METAMORPhos Ligand Kit component. For detailed technical note visit strem.com .		50mg 250mg
15-2212	1-[(2S)-1-(Di-o-tolylphosphinoxy)propan-2-yl]-3-phenylurea, min. 97% C ₂₄ H ₂₇ N ₂ P; FW: 406.46; white powdr. <i>moisture sensitive, (store cold)</i> Note: Sold under license from InCatT for research purposes only. WO2004/103559. UREAPhos and METAMORPhos Ligand Kit component. For detailed technical note visit strem.com .		50mg 250mg
26-1560	(S)-(-)-[(S)-2-Di(3,5-xylyl)phosphinoferrocenyl][2-di(4-trifluoromethylphenyl)phosphinophenyl]methanol, min. 97% (851308-48-0) See page 105		
26-1565	(S)-(-)-[(S)-2-Di(3,5-xylyl)phosphinoferrocenyl][2-di(3,5-xylyl)phosphinophenyl]methanol, min. 97% (851308-45-7) See page 105		
26-1555	(R)-(+)-1-[(R)-2-(2'-Di-3,5-xylylphosphinophenyl)ferrocenyl]ethylidene-3,5-xylylphosphine, min. 97% (894771-28-9) See page 105		
15-1835	n-Dodecylphosphonic acid, min. 97% DDPA (5137-70-2) CH ₃ (CH ₂) ₁₁ P(O)(OH) ₂ ; FW: 250.31; white to off-white powdr.; m.p. 96-98° Note: Long-Chain n-Alkylphosphonic Acid Kit component.		1g 5g
96-5650	DSM MonoPhos™ Ligand Kit See page 509		
15-0011	Ethyl/butyl phosphonic acid Silica (PhosphonicS POH1) white solid; SA: 380 m ² /g Note: Sold in collaboration with PhosphonicS Ltd. for research purposes only.		10g 50g
Technical Note:			
1. Applications include esterification, trans-esterification, hydrolysis, rearrangements, dehydration, protection and de-protection, cyclizations, etherifications. At the end of the reaction the solid silica catalyst can simply be filtered from the reaction mixture and reused.			
Particle size range: 60-200 microns			
Average pore size: 60Å			
Functional group loading : 0.8 to 1.0 mmol/g			
References:			
1. <i>Org. Process Res. Dev.</i> , 2007 , <i>11</i> , 406.			
15-2100	Ethylchlorophosphine, 98% (1498-40-4) C ₂ H ₅ PCl ₂ ; FW: 130.94; colorless liq.; b.p. 113-116°; f.p. 91°F; d. 1.26 <i>air sensitive, moisture sensitive, pyrophoric</i>		5g 25g
HAZ			
			
15-2150	Ethylidiphenylphosphine, 99% (607-01-2) (C ₂ H ₅)(C ₆ H ₅) ₂ P; FW: 214.25; colorless liq.; b.p. 130-132°/1 mm; f.p. >230°F; d. 1.04 <i>air sensitive</i>		5g 25g
HAZ			
15-2301	Ethyltriphenylphosphonium bromide, 99% (1530-32-1) C ₂ H ₅ (C ₆ H ₅) ₃ PBr; FW: 371.26; white to off-white powdr.; m.p. 206-208°		25g 100g

PHOSPHORUS (Compounds)

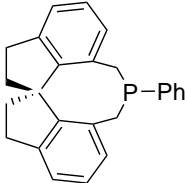
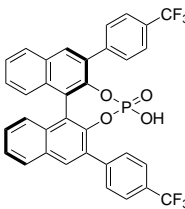
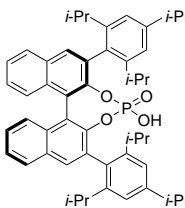

26-1266	1-[[(R) -Ferrocenyl-2-(S)-ethyl-1-dimethylamino)phenyl]-(R)-phosphino]-1'-dicyclohexylphosphinoferrocene, min. 97% Chenphos (952586-19-5) See page 106	
26-1265	1-[[(S) -Ferrocenyl-2-(R)-ethyl-1-dimethylamino)phenyl]-(S)-phosphino]-1'-dicyclohexylphosphinoferrocene, min. 97% Chenphos (1036373-39-3) See page 106	
93-1529 HAZ	Fluorophosphoric acid, 60-70% (13537-32-1) (HO) ₂ P(O)F; FW: 100.00; yellow liq. <i>moisture sensitive</i>	50g 250g
96-4100	Garphos™ Ligand Kit See page 510	
15-2400	n-Hexadecylphosphonic acid, min. 97% HDPA (4721-17-9) CH ₃ (CH ₂) ₁₅ P(O)(OH) ₂ ; FW: 306.42; white to off-white powdr.; m.p. 96-99° Note: Long-Chain n-Alkylphosphonic Acid Kit component.	1g 5g
93-1581	Hexadecyltri-n-butylphosphonium bromide, 98+% (14937-45-2) (C ₁₆ H ₃₃)(C ₄ H ₉) ₃ PBr; FW: 507.65; white xtl.; m.p. 54-56°	10g 50g
93-1531 HAZ	Hexafluorophosphoric acid, 60-70% in water (16940-81-1) HPF ₆ ; FW: 145.97; colorless to pale yellow liq.	250g 1kg
15-5184	(11aR)-(+)-5,6,10,11,12,13-Hexahydro-5-phenyl-4H-diinden[7,1-cd:1',7'-ef]phosphocin, min. 97% (R)-SITCP (856407-37-9) C ₂₅ H ₂₃ P; FW: 354.42; white solid; m.p. 148-149° <i>air sensitive</i> For detailed technical note visit strem.com .	25mg 100mg
		
15-5185	(11aS)-(+)-5,6,10,11,12,13-Hexahydro-5-phenyl-4H-diinden[7,1-cd:1',7'-ef]phosphocin, min. 97% (S)-SITCP (885701-78-0) C ₂₅ H ₂₃ P; FW: 354.42; white solid; m.p. 148-149° <i>air sensitive</i> For detailed technical note visit strem.com .	25mg 100mg
15-2410	n-Hexylphosphonic acid, min. 97% HPA (4721-24-8) CH ₃ (CH ₂) ₅ P(O)(OH) ₂ ; FW: 166.16; white to off-white powdr.; m.p. 105-106° Note: Long-Chain n-Alkylphosphonic Acid Kit component.	1g 5g
15-1392	(11bR)-4-Hydroxy-2,6-bis[4-(trifluoromethyl)phenyl]-4-oxide-dinaphtho[2,1-d:1',2'-f][1,3,2]dioxaphosphepin, 95%, (99% ee) (791616-59-6) C ₃₄ H ₁₉ F ₆ O ₄ P; FW: 636.5; White to light-yellow powdr. Note: Sold in collaboration with Daicel for research purposes only.	100mg
		
15-1393	(11bS)-4-Hydroxy-2,6-bis[4-(trifluoromethyl)phenyl]-4-oxide-dinaphtho[2,1-d:1',2'-f][1,3,2]dioxaphosphepin, 95%, (99% ee) (1264573-23-0) C ₃₄ H ₁₉ F ₆ O ₄ P; FW: 636.5; White to light-yellow powdr. Note: Sold in collaboration with Daicel for research purposes only.	100mg
15-1381	(11bR)-4-Hydroxy-2,6-bis[2,4,6-tris(1-methylethyl)phenyl]-4-oxide-dinaphtho[2,1-d:1',2'-f][1,3,2]dioxaphosphepin, 98%, (99% ee) (791616-63-2) C ₅₀ H ₅₇ O ₄ P; FW: 753; White to light-yellow powdr. Note: Sold in collaboration with Daicel for research purposes only.	100mg
		

PHOSPHORUS (Compounds)

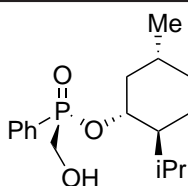
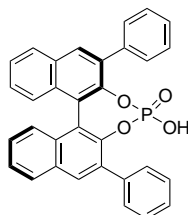
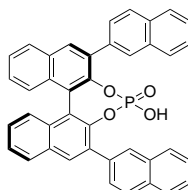
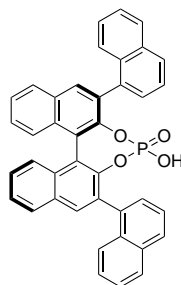
15-1382	(11bS)-4-Hydroxy-2,6-bis[2,4,6-tris(1-methylethyl)phenyl]-4-oxide-dinaphtho[2,1-d:1',2'-f][1,3,2]dioxaphosphepin, 98%, (99% ee) (874948-63-7) C ₅₀ H ₅₇ O ₄ P; FW: 753; White to light-yellow powder. Note: Sold in collaboration with Daicel for research purposes only.	100mg
15-1388	(11bR)-4-Hydroxy-2,6-di-1-naphthalenyl-4-oxide-dinaphtho[2,1-d:1',2'-f][1,3,2]dioxaphosphepin, 98%, (99% ee) (864943-23-7) C ₄₀ H ₂₅ O ₄ P; FW: 600.6; White to light-yellow powder. Note: Sold in collaboration with Daicel for research purposes only.	100mg
15-1389	(11bS)-4-Hydroxy-2,6-di-1-naphthalenyl-4-oxide-dinaphtho[2,1-d:1',2'-f][1,3,2]dioxaphosphepin, 98%, (99% ee) (929097-93-8) C ₄₀ H ₂₅ O ₄ P; FW: 600.6; White to light-yellow powder. Note: Sold in collaboration with Daicel for research purposes only.	100mg
15-1390	(11bR)-4-Hydroxy-2,6-di-2-naphthalenyl-4-oxide-dinaphtho[2,1-d:1',2'-f][1,3,2]dioxaphosphepin, 98%, (99% ee) (791616-56-3) C ₄₀ H ₂₅ O ₄ P; FW: 600.6; White to light-yellow powder. Note: Sold in collaboration with Daicel for research purposes only.	100mg
15-1391	(11bS)-4-Hydroxy-2,6-di-2-naphthalenyl-4-oxide-dinaphtho[2,1-d:1',2'-f][1,3,2]dioxaphosphepin, 98%, (99% ee) (874948-60-4) C ₄₀ H ₂₅ O ₄ P; FW: 600.6; White to light-yellow powder. Note: Sold in collaboration with Daicel for research purposes only.	100mg
15-1386	(11bR)-4-Hydroxy-2,6-diphenyl-4-oxide-dinaphtho[2,1-d:1',2'-f][1,3,2]dioxaphosphepin, 98%, (99% ee) (695162-86-8) C ₃₂ H ₂₁ O ₄ P; FW: 500.5; White to light-yellow powder. Note: Sold in collaboration with Daicel for research purposes only.	100mg
15-1387	(11bS)-4-Hydroxy-2,6-diphenyl-4-oxide-dinaphtho[2,1-d:1',2'-f][1,3,2]dioxaphosphepin, 98%, (99% ee) (874948-59-1) C ₃₂ H ₂₁ O ₄ P; FW: 500.5; White to light-yellow powder. Note: Sold in collaboration with Daicel for research purposes only.	100mg
15-2900	1-Hydroxyethylidene-1,1-diphosphonic acid, min. 95% HEDP (2809-21-4) C(OH)(CH ₃)(PO ₃ H ₂) ₂ ; FW: 206.03; white powder.	5g 25g
15-2928	(Sp)-Hydroxymethylphenylphosphinic acid [(−)-(1R,2S,2R)-2-i-propyl-5-methylcyclohexanol] ester, 99% (1508260-88-5) C ₁₇ H ₂₇ O ₄ P; FW: 310.37; white powder. hygroscopic Note: Patent pending 13/912,392	100mg 500mg

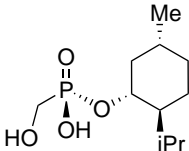
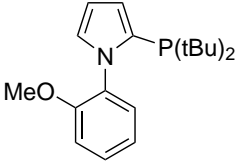
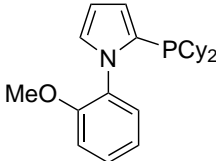
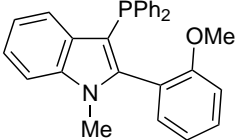
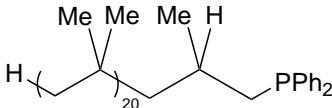

PHOSPHORUS (Compounds)

15-2915	(Rp)-Hydroxymethylphosphonic acid [(-)-(1R,2S,2R)-2-i-propyl-5-methylcyclohexanol] ester, 99% (1823532-14-4) C ₁₁ H ₂₃ O ₃ P; FW: 234.27; white solid <i>hygroscopic, (store cold)</i> Note: Patent pending.		100mg 500mg
96-1525	Long-Chain n-Alkylphosphonic Acid Kit See page 540		
96-3750	Maruoka Chiral Phase-Transfer Phosphonium Organocatalyst Kit See page 487		
15-2975	N-(2-Methoxyphenyl)-2-(di-t-butylphosphino) pyrrole, min. 95% [cataCXium® POMetB] (1053658-91-5) C ₁₉ H ₂₈ NOP; FW: 317.41; white to yellowish pwdr. <i>air sensitive</i> Note: Sold in collaboration with Solvias for research purposes only. Patent Application pending. Solvias cataCXium® Ligand Kit component. For detailed technical note visit strem.com .		500mg 2g
15-2980	1-(2-Methoxyphenyl)-2-(dicyclohexylphosphino) pyrrole, min. 95% [cataCXium® POMeCy] (672937-63-2) C ₂₃ H ₃₂ NOP; FW: 369.48; white to yellow pwdr.; m.p. 96-97° <i>air sensitive</i> Note: Sold in collaboration with Solvias for research purposes only. Patent Application pending. Solvias cataCXium® Ligand Kit component. For detailed technical note visit strem.com .		500mg 2g
15-1091	2-(2-Methoxyphenyl)-1-methyl-3- diphenylphosphino)-1H-indole, min. 98% PPh ₂ - Andole-Phos (1242759-01-8) C ₂₈ H ₂₄ NOP; FW: 421.47; white to off-white pwdr. For detailed technical note visit strem.com .		500mg 2g
15-3155 amp HAZ	{2-Methyl-3-[polyisobutyl(20)]propyl} diphenylphosphine (50% in heptane/poly- isobutylene) H[CH ₂ C(Me) ₂] ₂₀ CH ₂ C(Me)HCH ₂ P(Ph) ₂ ; FW: 1364; colorless liq.		1g 5g
15-3220 amp HAZ 	Methyldichlorophosphine, 97% (676-83-5) CH ₃ PCL ₂ ; FW: 116.92; colorless to pale yellow liq.; b.p. 81°; d. 1.31 <i>air sensitive, moisture sensitive</i> Note: May be slightly turbid. For sale in USA. For other countries contact Strem.		5g 25g
15-3250	Methyldiphenylphosphine, 99% (1486-28-8) CH ₃ (C ₆ H ₅) ₂ P; FW: 200.22; colorless liq.; b.p. 118-120°/2.2 mm; f.p. >230°F; d. 1.065 <i>air sensitive</i>		5g 25g 100g

PHOSPHORUS (Compounds)

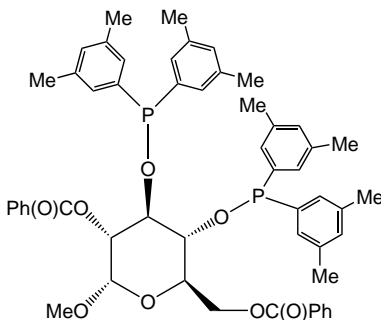
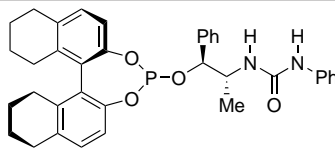
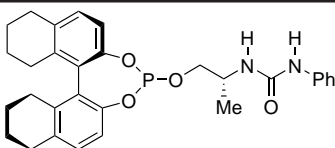
15-3300	Methyl α -D-glucopyranoside-2,6-dibenzoate-3,4-di(bis(3,5-dimethylphenyl)phosphinite), min. 95% CARBOPHO (158214-06-3) C ₅₃ H ₅₆ O ₈ P ₂ ; FW: 882.98; white powdr.; m.p. 162-164° air sensitive For detailed technical note visit strem.com .		00mg 500mg
15-3400	Methyltriphenylphosphonium bromide, 98+% (1779-49-3) CH ₃ (C ₆ H ₅) ₃ PBr; FW: 357.23; white xtl.; m.p. 234-235°		50g 250g
93-4249	12-Molybdophosphoric acid hydrate (ACS) (51429-74-4) See page 138		
15-1530	(S)-2-(1-Naphthyl)-8-diphenylphosphino-1-[(R)-3,5-dioxa-4-phosphacyclohepta[2,1-a;3,4-a']dinaphthalen-4-yl]-1,2-dihydroquinoline toluene adduct, min. 97% (Ra,Sc)-(1-Nph)-Quinaphos (1242168-77-9) C ₅₁ H ₃₅ NO ₂ P ₂ ·1/2C ₇ H ₈ ; FW: 755.78 (801.85); white powdr. moisture sensitive Note: **Limited quantities available** For detailed technical note visit strem.com .		50mg 250mg
15-3490	(S)(+)-Neomenthylidiphenylphosphine, 98% (S)-NMDPP (43077-29-8) C ₁₀ H ₁₉ P(C ₆ H ₅) ₂ ; FW: 324.25; white xtl.; m.p. 90-92° air sensitive		500mg 2g
93-0739	Nitronium hexafluorophosphate, min. 97% (19200-21-6) See page 204		
93-0736	Nitronium hexafluorophosphate, min. 97% (16921-91-8) See page 204		
15-3510	n-Octadecylphosphonic acid, min. 97% ODPa (4724-47-4) CH ₃ (CH ₂) ₁₇ P(O)(OH) ₂ ; FW: 334.47; white to off-white powdr.; m.p. 100-101° Note: Long-Chain n-Alkylphosphonic Acid Kit component.		1g 5g 25g
15-2224	1-((1S,2R)-1-((11bR)-8,9,10,11,12,13,14,15-Octahydrodinaphtho[2,1-d:1',2'-f][1,3,2]dioxaphosphepin-4-yloxy)-1-phenylpropan-2-yl)-3-phenylurea, min. 97% (1858224-21-1) C ₃₆ H ₃₇ N ₂ O ₄ P; FW: 592.86; white powdr. moisture sensitive, (store cold) Note: Sold under license from InCat for research purposes only. WO2004/103559. UREAphos and METAMORPhos Ligand Kit component. For detailed technical note visit strem.com .		50mg 250mg
15-2222	1-((2R)-1-((11bR)-8,9,10,11,12,13,14,15-Octahydrodinaphtho[2,1-d:1',2'-f][1,3,2]dioxaphosphepin-4-yloxy]propan-2-yl)-3-phenylurea, min. 97% (1858223-90-1) C ₃₀ H ₃₃ N ₂ O ₄ P; FW: 516.57; white powdr. moisture sensitive, (store cold) Note: Sold under license from InCat for research purposes only. WO2004/103559. UREAphos and METAMORPhos Ligand Kit component. For detailed technical note visit strem.com .		50mg

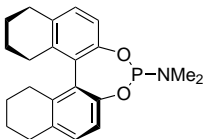
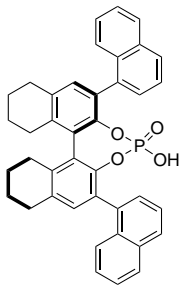
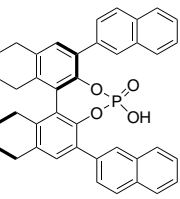
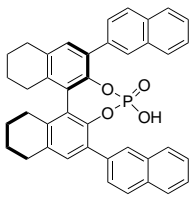
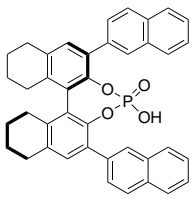
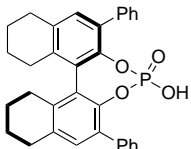
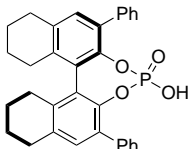
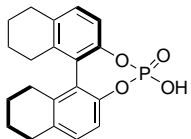
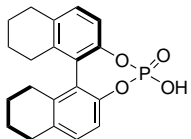

PHOSPHORUS (Compounds)

15-3495	(S)(+)-(8,9,10,11,12,13,14,15-Octahydro-3,5-dioxo-4-phospha-cyclohepta[2,1-a;3,4-a']dinaphthalen-4-yl)dimethylamine, 99% (389130-06-7) C ₂₂ H ₂₆ NO ₂ P; FW: 367.42; white powdr.; m.p. 112-113° moisture sensitive, (store cold) Note: Sold in collaboration with DSM for research purposes only. Patent WO 0204466. DSM's MonoPhos™ Ligand Kit component. For detailed technical note visit strem.com .		100mg 500mg
15-1383	(11bR)-8,9,10,11,12,13,14,15-Octahydro-4-hydroxy-2,6-di-1-naphthalenyl-4-oxide-dinaphtho[2,1-d:1',2'-f][1,3,2]dioxaphosphepin, 98%, (99% ee) (1242066-20-1) C ₄₀ H ₃₃ O ₄ P; FW: 608.7; White to light-yellow powdr. Note: Sold in collaboration with Daicel for research purposes only.		100mg
15-1384	(11bS)-8,9,10,11,12,13,14,15-Octahydro-4-hydroxy-2,6-di-1-naphthalenyl-4-oxide-dinaphtho[2,1-d:1',2'-f][1,3,2]dioxaphosphepin, 98%, (99% ee) C ₄₀ H ₃₃ O ₄ P; FW: 608.7; White to light-yellow powdr. Note: Sold in collaboration with Daicel for research purposes only.		100mg
15-1378	(11bR)-8,9,10,11,12,13,14,15-Octahydro-4-hydroxy-2,6-di-2-naphthalenyl-4-oxide-dinaphtho[2,1-d:1',2'-f][1,3,2]dioxaphosphepin, 98%, (99% ee) (922711-75-9) C ₄₀ H ₃₃ O ₄ P; FW: 608.7; White to light-yellow powdr. Note: Sold in collaboration with Daicel for research purposes only.		100mg
15-1379	(11bS)-8,9,10,11,12,13,14,15-Octahydro-4-hydroxy-2,6-di-2-naphthalenyl-4-oxide-dinaphtho[2,1-d:1',2'-f][1,3,2]dioxaphosphepin, 98%, (99% ee) C ₄₀ H ₃₃ O ₄ P; FW: 608.7; White to light-yellow powdr. Note: Sold in collaboration with Daicel for research purposes only.		100mg
15-1396	(11bR)-8,9,10,11,12,13,14,15-Octahydro-4-hydroxy-2,6-diphenyl-4-oxide-dinaphtho[2,1-d:1',2'-f][1,3,2]dioxaphosphepin, 98%, (99% ee) (791616-65-4) C ₃₂ H ₂₉ O ₄ P; FW: 508.5; White to light-yellow powdr. Note: Sold in collaboration with Daicel for research purposes only.		100mg
15-1397	(11bS)-8,9,10,11,12,13,14,15-Octahydro-4-hydroxy-2,6-diphenyl-4-oxide-dinaphtho[2,1-d:1',2'-f][1,3,2]dioxaphosphepin, 98%, (99% ee) (945852-48-2) C ₃₂ H ₂₉ O ₄ P; FW: 508.5; White to light-yellow powdr. Note: Sold in collaboration with Daicel for research purposes only.		100mg
15-1370	(11bR)-8,9,10,11,12,13,14,15-Octahydro-4-hydroxy-4-oxide-dinaphtho[2,1-d:1',2'-f][1,3,2]dioxaphosphepin, 98%, (99% ee) (297752-25-1) C ₂₀ H ₂₁ O ₄ P; FW: 356.4; White to light-yellow powdr. Note: Sold in collaboration with Daicel for research purposes only.		100mg
15-1371	(11bS)-8,9,10,11,12,13,14,15-Octahydro-4-hydroxy-4-oxide-dinaphtho[2,1-d:1',2'-f][1,3,2]dioxaphosphepin, 98%, (99% ee) (1193697-61-8) C ₂₀ H ₂₁ O ₄ P; FW: 356.4; White to light-yellow powdr. Note: Sold in collaboration with Daicel for research purposes only.		100mg

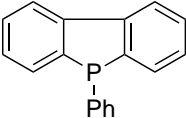
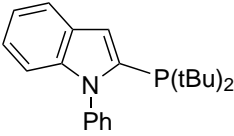
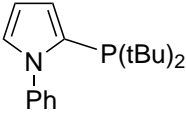
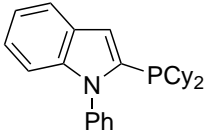
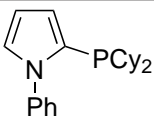

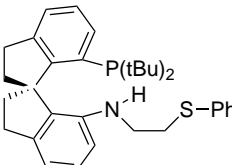
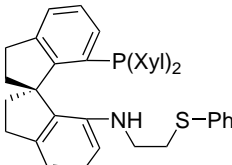
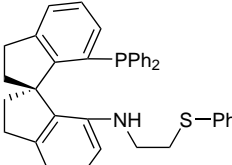
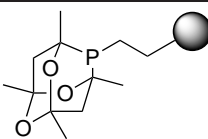

PHOSPHORUS (Compounds)

15-3520	n-Octylphosphonic acid, min. 97% OPA (4724-48-5) CH ₃ (CH ₂) ₇ P(O)(OH) ₂ ; FW: 194.21; white to off-white powdr.; m.p. 102-103° Note: Long-Chain n-Alkylphosphonic Acid Kit component.		1g 5g
26-3575	1,2,3,4,5-Pentaphenyl-1'-(di-t-butylphosphino)ferrocene, 95% CTC-Q-PHOS (312959-24-3) See page 110		
96-3780	PhenCar-Phos Ligand Kit See page 515		
15-3525	5-Phenyl-5H-benzo[b]phosphindole, 99% (1088-00-2) C ₁₈ H ₁₃ P; FW: 260.27; off-white to beige solid		100mg 500mg
15-3550	N-Phenyl-2-(di-t-butylphosphino)indol, min. 98% [cataCXium® PlntB] (740815-37-6) C ₂₂ H ₂₈ NP; FW: 337.44; white to yellow powdr. <i>air sensitive</i> Note: Sold in collaboration with Solvias for research purposes only. Patent Application pending. Solvias cataCXium® Ligand Kit component. For detailed technical note visit strem.com .		500mg 2g
15-3600	N-Phenyl-2-(di-t-butylphosphino)pyrrole, 95+% [cataCXium® PtB] (672937-61-0) C ₁₈ H ₂₆ NP; FW: 287.38; white to yellow powdr.; m.p. 51° <i>air sensitive</i> Note: Sold in collaboration with Solvias for research purposes only. Patent Application pending. Solvias cataCXium® Ligand Kit component. For detailed technical note visit strem.com .		500mg 2g
15-4150	Phenyldichlorophosphine, 97% (644-97-3) HAZ C ₆ H ₅ PCl ₂ ; FW: 178.99; yellow liq.; m.p. -51°; b.p. 225°; f.p. >230°F; d. 1.319 (20°) <i>air sensitive, moisture sensitive</i>		50g 250g 1kg
15-4155	Phenyldichlorophosphine, 99% (644-97-3) HAZ C ₆ H ₅ PCl ₂ ; FW: 178.99; colorless to light yellow liq.; m.p. -51°; b.p. 225°; f.p. >230°F; d. 1.319 (20°) <i>air sensitive, moisture sensitive</i>		50g 250g
15-4158	Phenyldichlorophosphine oxide, min. 94% (824-72-6) HAZ C ₆ H ₅ P(O)Cl ₂ ; FW: 194.99; colorless to light yellow liq.; m.p. 3°; b.p. 258°; f.p. 400°F; d. 1.394 (25°) <i>air sensitive, moisture sensitive</i>		50g 250g
15-3605	N-Phenyl-2-(dicyclohexylphosphino)indol, min. 95% [cataCXium® PlnCy] (740815-36-5) C ₂₆ H ₃₂ NP; FW: 389.51; white to yellow powdr. <i>air sensitive</i> Note: Sold in collaboration with Solvias for research purposes only. Patent Application pending. Solvias cataCXium® Ligand Kit component. For detailed technical note visit strem.com .		500mg 2g
15-3610	N-Phenyl-2-(dicyclohexylphosphino)pyrrole, 90% [cataCXium® PCy] (672937-60-9) C ₂₂ H ₃₀ NP; FW: 339.45; white to yellow powdr.; m.p. 92° <i>air sensitive</i> Note: Contains ca. 10% of the regioisomer, N-(2-(dicyclohexylphosphino-phenyl)pyrrole. Sold in collaboration with Solvias for research purposes only. Patent Application pending. Solvias cataCXium® Ligand Kit component. For detailed technical note visit strem.com .		500mg 2g
15-4250	Phenyldimethoxyphosphine, 98% (2946-61-4) (C ₆ H ₅)(CH ₃ O) ₂ P; FW: 170.15; colorless liq.; b.p. 77-79°/7 mm; f.p. >230°F; d. 1.072 <i>air sensitive, moisture sensitive</i>		1g 5g

PHOSPHORUS (Compounds)

15-4400 amp HAZ 	Phenylphosphine, 99% (638-21-1) $C_6H_5PH_2$; FW: 110.10; colorless liq.; b.p. 160°; f.p. 165°F; d. 1.001 <i>pyrophoric, STENCH</i>	2g 10g	
15-4402 HAZ 	Phenylphosphine, 99% (Sure/Seal™ bottle) (638-21-1) $C_6H_5PH_2$; FW: 110.10; colorless liq.; b.p. 160°; f.p. 165°F; d. 1.001 <i>pyrophoric, STENCH</i>	25g	
15-4403 HAZ	Phenylphosphine, 99% (10 wt% in hexanes) (638-21-1) $C_6H_5PH_2$; FW: 110.10; colorless liq. <i>air sensitive, STENCH</i>	20g 100g	
93-1536 HAZ	Phenylphosphinic acid, 99% (1779-48-2) $C_6H_5P(O)(OH)H$; FW: 142.09; white xtl.; m.p. 83-85°	100g 500g	
26-1269	(S, R(p), S(SPO)-1-Phenylphosphinoyl)-2-[1-(t-butylphosphino)ethyl] , min. 97% JoSPOphos (1221746-56-0) See page 110		
26-1268	(R,S(p), R(SPO)-1-Phenylphosphinoyl)-2-[1-(di-t-butylphosphino)ethyl] ferrocene, min. 97% JoSPOphos (1221746-66-2) See page 110		
93-1537 HAZ	Phenylphosphonic acid, 98% (1571-33-1) $(C_6H_5)_2P(O)(OH)_2$; FW: 158.09; white xtl.; m.p. 163-166°	50g 250g 1kg	
15-1605 NEW	(R)-(+)-7-[N-(2-Phenylthio)ethylamino]-7'-[bis(3,5-di-t-butylphenyl)phosphino]-2,2',3,3'-tetrahydro-1,1'-spiroindane, 97+% (>99% ee) [(R)-DTB-SpiroSAP-Ph] (1809609-38-8) $C_{53}H_{86}$ NPS; FW: 780.14; off-white solid; m.p. 58-60° <i>air sensitive</i> For detailed technical note visit strem.com .	25mg 100mg	
15-1645 NEW	(R)-(+)-7-[N-(2-Phenylthio)ethylamino]-7'-[bis(3,5-dimethylphenyl)phosphino]-2,2',3,3'-tetrahydro-1,1'-spiroindane, 97+% (>99% ee) [(R)-Xyl-SpiroSAP-Ph] (1809609-39-9) $C_{41}H_{42}$ NPS; FW: 611.82; off-white solid; m.p. 58-60° <i>air sensitive</i>	25mg 100mg	
Technical Note: 1. See 15-1605 (page 319)			
15-1643 NEW	(R)-(+)-7-[N-(2-Phenylthio)ethylamino]-7'-[diphenylphosphino]-2,2',3,3'-tetrahydro-1,1'-spiroindane, 97+% (>99% ee) [(R)-Ph-SpiroSAP-Ph] (1809609-40-2) $C_{37}H_{34}$ NPS; FW: 555.71; off-white solid; m.p. 55-58° <i>air sensitive</i>	25mg 100mg	
Technical Note: 1. See 15-1605 (page 319)			
15-4510	Phosphaadamantane ethyl Silica (free phosphine ligand) (PhosphonicS PAR) white solid Note: Sold in collaboration with PhosphonicS Ltd. for research purposes only.	500mg 2g	
Technical Note: 1. Supported, free phosphine used in the preparation of immobilized phosphine metal complexes. Particle size range: 60-200 microns Functional group loading : 0.4 to 0.8 mmol/g			

PHOSPHORUS (Compounds)

96-1650	Phosphine Ligand Kit for Palladium-Catalyzed Carbon-Carbon and Carbon-Heteroatom Bond Formation See page 515	
26-3620	Phosphinoferrrocene, 98% (83528-85-2) See page 110	
15-4530 HAZ	Phosphonitrilic chloride trimer, 98.5% (940-71-6) (PNCl ₂) ₃ ; FW: 347.66; white xtl.; m.p. 128.8°; b.p. 127°/12 mm; d. 1.98 <i>moisture sensitive</i>	10g 50g
93-1541 HAZ	Phosphoric acid (ACS), 85% (7664-38-2) H ₃ PO ₄ ; FW: 98.00; colorless liq.; d. 1.685	1kg
93-1550 HAZ	Phosphorus(III) bromide, 97+% (7789-60-8) PBr ₃ ; FW: 270.70; colorless to pale yellow liq.; m.p. -40°; b.p. 172.9°; d. 2.852 (15°) <i>air sensitive, moisture sensitive</i>	100g 500g
93-1587 HAZ 	Phosphorus(III) chloride, 98+% (7719-12-2) PCl ₃ ; FW: 137.33; colorless liq.; m.p. -111.8°; b.p. 76°; d. 1.574 <i>moisture sensitive</i>	250g
93-1588 amp HAZ 	Phosphorus(III) chloride (99.998%-P) PURATREM (7719-12-2) PCl ₃ ; FW: 137.33; m.p. -111.8°; b.p. 76°; d. 1.574 <i>moisture sensitive</i>	10g 50g
93-1545 HAZ	Phosphorus(V) chloride, 98% (10026-13-8) PCl ₅ ; FW: 208.24; white to pale yellow xtl.; m.p. 166.8° subl. <i>moisture sensitive</i>	250g 1kg
93-1548 HAZ	Phosphorus(V) oxide, 98+% (ACS) (1314-56-3) P ₂ O ₅ ; FW: 141.95; white powdr.; m.p. 580-585°; b.p. 300° subl.; d. 2.39 <i>hygroscopic</i>	500g 4 x 500g
93-1592 HAZ	Phosphorus(V) oxide (99.99%-P) PURATREM (1314-56-3) P ₂ O ₅ ; FW: 141.95; white powdr.; m.p. 580-585°; b.p. 300° subl.; d. 2.39 <i>hygroscopic</i>	50g 250g
93-1586 amp HAZ	Phosphorus oxybromide, 99% (7789-59-5) POBr ₃ ; FW: 286.73; colorless to light yellow xtl.; m.p. 56°; b.p. 193°; d. 2.822 <i>moisture sensitive</i>	5g 25g 100g
93-1543 HAZ 	Phosphorus oxychloride, 98+% (10025-87-3) POCl ₃ ; FW: 153.35; colorless liq.; m.p. 2°; b.p. 105.3°; d. 1.675 <i>moisture sensitive</i>	250g 1kg
97-8875 amp HAZ 	Phosphorus oxychloride, elec. gr. (99.999%-P) PURATREM (10025-87-3) POCl ₃ ; FW: 153.35; colorless liq.; m.p. 2°; b.p. 105.3°; d. 1.675 <i>moisture sensitive</i>	25g 100g
96-7050	PINAP Ligand Kit See page 516	
93-1552 HAZ	Polyphosphoric acid (83% P₂O₅) (8017-16-1) H ₃ PO ₄ ·P ₂ O ₅ ; FW: 239.95; viscous liq. <i>hygroscopic</i>	250g 1kg
19-2610	Potassium di-t-butylphosphate, min. 91% (contains <5% water) (33494-80-3) See page 341	
15-4581 amp HAZ	n-Propyldichlorophosphine, min. 98% (15573-31-6) n-C ₃ H ₇ PCl ₂ ; FW: 144.97; colorless liq.; b.p. 133°; d. 1.118 <i>air sensitive, moisture sensitive</i>	2g 10g
26-4011	(R,R)-[2-(4'-i-Propyloxazolin-2'-yl)ferrocenyl]diphenylphosphine, min. 97% (541540-70-9) See page 110	

PHOSPHORUS (Compounds)

26-4010	(S,S)-[2-(4'-i-Propyloxazolin-2'-yl)ferrocenyldiphenylphosphine, min. 97% (163169-29-7) See page 110	
96-2310	SKP Ligand Kit for asymmetric-allylic amination and cyclopropanation See page 517	
96-6651	Solvias cataCXium® Ligand Kit for C-X coupling reactions See page 518	
96-3655	Solvias (R)-MeO-BIPHEP Ligand Kit See page 523	
96-3656	Solvias (S)-MeO-BIPHEP Ligand Kit See page 524	
96-0060	Spiro Bisphosphine Ligand Kit See page 525	
96-0065	Spiro Monophosphite and Monophosphoramidite Ligand Kit See page 526	
96-6950	Takasago BINAP Ligand Kit See page 527	
96-6900	Takasago SEGPPOS® Ligand Kit See page 528	
93-1579	Tetra-n-butylphosphonium bromide, 98% (3115-68-2) HAZ (C ₄ H ₉) ₄ P ⁺ Br ⁻ ; FW: 339.35; white xtl.; m.p. 100-103° <i>hygroscopic</i>	25g 100g
15-1318	Tetrabutylphosphonium chloride (80-82 wt% solution in water) (2304-30-5) HAZ C ₁₆ H ₃₆ ClP; FW: 294.88; colorless to pale-yellow liq.	5g 25g
15-5145	n-Tetradecylphosphonic acid, min. 97% TDPA (4671-75-4) CH ₃ (CH ₂) ₁₃ P(O)(OH) ₂ ; FW: 278.37; white to off-white powdr.; m.p. 96-98° Note: Long-Chain n-Alkylphosphonic Acid Kit component.	1g 5g 25g
15-5162	(11aR)-(+)-10,11,12,13-Tetrahydroindeno[7,1-de:1',7'-fg][1,3,2]dioxaphosphocin-5-bis((R)-1-phenylethyl)amine, min. 98% (R)-SIPHOS-PE (500997-69-3) C ₃₃ H ₃₂ NO ₂ P; FW: 505.59; white solid; m.p. 98-100° <i>moisture sensitive</i> Note: Spiro Monophosphite and Monophosphoramidite Ligand kit component. For detailed technical note visit strem.com .	100mg 500mg
15-5163	(11aS)-(-)-10,11,12,13-Tetrahydroindeno[7,1-de:1',7'-fg][1,3,2]dioxaphosphocin-5-bis((R)-1-phenylethyl)amine, min. 98% (S)-SIPHOS-PE (500997-70-6) C ₃₃ H ₃₂ NO ₂ P; FW: 505.59; white solid; m.p. 99-101° <i>moisture sensitive</i> Note: Spiro Monophosphite and Monophosphoramidite Ligand Kit component. For detailed technical note visit strem.com .	100mg 500mg
15-5150	(11aR)-(+)-10,11,12,13-Tetrahydroindeno[7,1-de:1',7'-fg][1,3,2]dioxaphosphocin-5-dimethylamine, min. 98% (R)-SIPHOS (443965-14-8) C ₁₉ H ₂₀ NO ₂ P; FW: 325.34; white solid; m.p. 95-96° <i>moisture sensitive</i> Note: Spiro Monophosphite and Monophosphoramidite Ligand Kit component. For detailed technical note visit strem.com .	100mg 500mg
15-5151	(11aS)-(-)-10,11,12,13-Tetrahydroindeno[7,1-de:1',7'-fg][1,3,2]dioxaphosphocin-5-dimethylamine, min. 98% (S)-SIPHOS (443965-10-4) C ₁₉ H ₂₀ NO ₂ P; FW: 325.34; white solid; m.p. 95-96° <i>moisture sensitive</i> Note: Spiro Monophosphite and Monophosphoramidite Ligand Kit component. For detailed technical note visit strem.com .	100mg 500mg

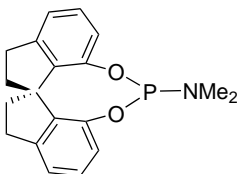
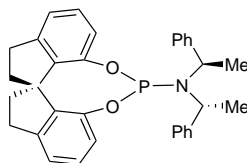

PHOSPHORUS (Compounds)

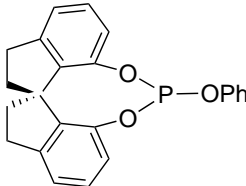
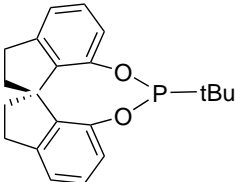
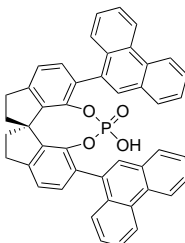
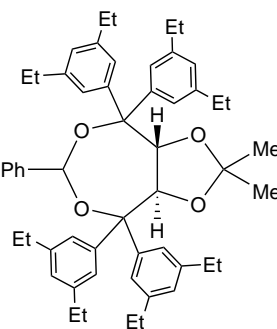
15-5156	(11aR)-(+)-10,11,12,13-Tetrahydrodiindeno[7,1-de:1',7'-fg][1,3,2]dioxaphosphocin-5-phenoxy, min. 98% (R)-ShiP (656233-53-3) C ₂₃ H ₁₉ O ₃ P; FW: 374.37; white solid; m.p. 104-106° <i>moisture sensitive</i> Note: Spiro Monophosphite and Monophosphoramidite Ligand Kit component. For detailed technical note visit strem.com .		100mg 500mg
15-5157	(11aS)-(-)-10,11,12,13-Tetrahydrodiindeno[7,1-de:1',7'-fg][1,3,2]dioxaphosphocin-5-phenoxy, min. 98% (S)-ShiP (885701-71-3) C ₂₃ H ₁₉ O ₃ P; FW: 374.37; white solid; m.p. 102-103° <i>moisture sensitive</i> Note: Spiro Monophosphite and Monophosphoramidite Ligand Kit component. For detailed technical note visit strem.com .		100mg 500mg
15-5130	(11aR)-(+)-10,11,12,13-Tetrahydro-5-(1,1-dimethylethyl)diindeno[7,1-de,1',7'-fg][1.3.2]dioxaphosphocin, 97% (R)-FuP-tBu C ₂₁ H ₂₃ O ₂ P; FW: 338.38; white solid <i>moisture sensitive</i> For detailed technical note visit strem.com .		25mg 100mg
15-5131	(11aS)-(-)-10,11,12,13-Tetrahydro-5-(1,1-dimethylethyl)diindeno[7,1-de,1',7'-fg][1.3.2]dioxaphosphocin, 97% (S)-FuP-tBu (912457-08-0) C ₂₁ H ₂₃ O ₂ P; FW: 338.38; white solid <i>moisture sensitive</i> For detailed technical note visit strem.com .		25mg 100mg
15-1363 NEW	(11aR)-10,11,12,13-Tetrahydro-5-hydroxy-3,7-di-9-phenanthrenyl-5-oxide-diindeno[7,1-de:1',7'-fg][1,3,2]dioxaphosphocin, min. 98% (1372719-93-1) C ₄₅ H ₃₁ O ₄ P; FW: 666.70; white to light-yellow powdr. Note: Sold in collaboration with Daicel for research purposes only. For detailed technical note visit strem.com .		25mg 100mg
15-1364 NEW	(11aS)-10,11,12,13-Tetrahydro-5-hydroxy-3,7-di-9-phenanthrenyl-5-oxide-diindeno[7,1-de:1',7'-fg][1,3,2]dioxaphosphocin, min. 98% (1585988-92-6) C ₄₅ H ₃₁ O ₄ P; FW: 666.70; white to light-yellow powdr. Note: Sold in collaboration with Daicel for research purposes only. For detailed technical note visit strem.com .		25mg 100mg
15-1517	(3aR,8aR)-(-)-4,4,8,8-Tetrakis(3,5-diethylphenyl) tetrahydro-2,2-dimethyl-6-phenyl-1,3-dioxolo [4,5-e]dioxaphosphepin (1187446-93-0) C ₅₃ H ₆₅ O ₄ P; FW: 797.06; off-white powdr. For detailed technical note visit strem.com .		100mg 500mg

PHOSPHORUS (Compounds)



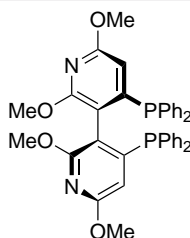
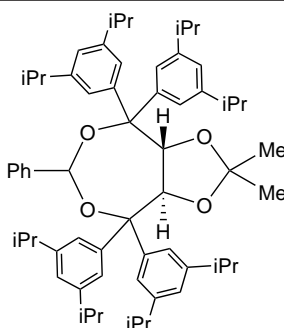
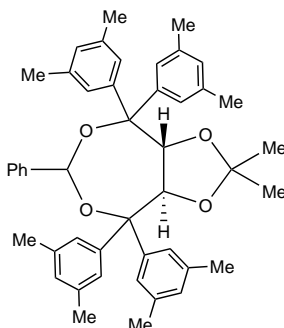

15-1518	(3aS,8aS)-(+)-4,4,8,8-Tetrakis(3,5-diethylphenyl)tetrahydro-2,2-dimethyl-6-phenyl-1,3-dioxolo[4,5-e]dioxaphosphepin C ₃₃ H ₆₅ O ₄ P; FW: 797.06; off-white powdr. For detailed technical note visit strem.com .	100mg 500mg
15-1511	(3aR,8aR)-(-)-4,4,8,8-Tetrakis(3,5-dimethylphenyl)tetrahydro-2,2-dimethyl-6-phenyl-1,3-dioxolo[4,5-e]dioxaphosphepin (1019840-96-0) C ₄₅ H ₄₉ O ₄ P; FW: 684.84; off-white solid For detailed technical note visit strem.com .	100mg 500mg
15-1512	(3aS,8aS)-(+)-4,4,8,8-Tetrakis(3,5-dimethylphenyl)tetrahydro-2,2-dimethyl-6-phenyl-1,3-dioxolo[4,5-e]dioxaphosphepin (1169835-86-2) C ₄₅ H ₄₉ O ₄ P; FW: 684.84; off-white solid For detailed technical note visit strem.com .	100mg 500mg
15-1513	(3aR,8aR)-(-)-4,4,8,8-Tetrakis(3,5-di-i-propylphenyl)tetrahydro-2,2-dimethyl-6-phenyl-1,3-dioxolo[4,5-e]dioxaphosphepin (1361146-90-8) C ₆₁ H ₈₁ O ₄ P; FW: 909.27; off-white powdr. For detailed technical note visit strem.com .	100mg 500mg
15-1514	(3aS,8aS)-(+)-4,4,8,8-Tetrakis(3,5-di-i-propylphenyl)tetrahydro-2,2-dimethyl-6-phenyl-1,3-dioxolo[4,5-e]dioxaphosphepin (1422371-27-4) C ₆₁ H ₈₁ O ₄ P; FW: 909.27; off-white powdr. For detailed technical note visit strem.com .	100mg 500mg
15-5201	(S)-(-)-2,2',6,6'-Tetramethoxy-4,4'-bis(diphenylphosphino)-3,3'-bipyridine, min. 95% CTH-(S)-P-Phos (362524-23-0) C ₃₈ H ₃₄ N ₂ O ₄ P ₂ ; FW: 644.64; white to pale yellow powdr. Note: Sold in collaboration with Johnson Matthey for research purposes only. US patent Application No US Patent 5 886 182, 1999 and patents arising therefrom. For detailed technical note visit strem.com .	100mg 500mg
15-5200	(R)-(+)-2,2',6,6'-Tetramethoxy-4,4'-bis(diphenylphosphino)-3,3'-bipyridine, min. 97% CTH-(R)-P-Phos (221012-82-4) C ₃₈ H ₃₄ N ₂ O ₄ P ₂ ; FW: 644.64; white to pale yellow powdr. Note: Sold in collaboration with Johnson Matthey for research purposes only. US patent Application No US Patent 5 886 182, 1999 and patents arising therefrom. For detailed technical note visit strem.com .	100mg 500mg

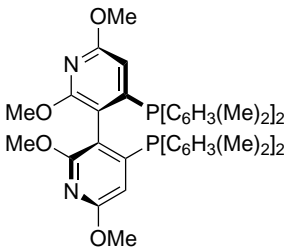
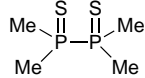
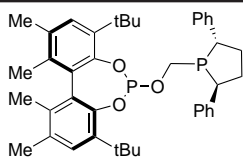
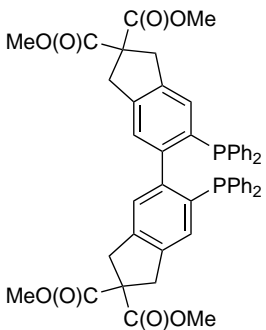
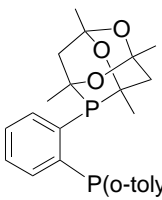
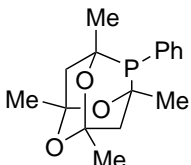

PHOSPHORUS (Compounds)

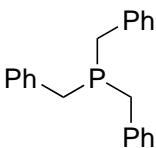
15-5211	(S)-(-)-2,2',6,6'-Tetramethoxy-4,4'-bis(di(3,5-xylyl)phosphino)-3,3'-bipyridine, min. 95% CTH-(S)-Xylyl-P-Phos (443347-10-2) C ₄₆ H ₅₀ N ₂ O ₄ P ₂ ; FW: 756.85; white to pale yellow pwdr. Note: Sold in collaboration with Johnson Matthey for research purposes only. US patent Application No US Patent 5 886 182, 1999 and patents arising therefrom. For detailed technical note visit strem.com .		100mg 500mg
15-5210	(R)-(+)-2,2',6,6'-Tetramethoxy-4,4'-bis(di(3,5-xylyl)phosphino)-3,3'-bipyridine, min. 97% CTH-(R)-Xylyl-P-PHOS (442905-33-1) C ₄₆ H ₅₀ N ₂ O ₄ P ₂ ; FW: 756.85; white to pale yellow pwdr. Note: Sold in collaboration with Johnson Matthey for research purposes only. US patent Application No US Patent 5 886 182, 1999 and patents arising therefrom. For detailed technical note visit strem.com .		100mg 500mg
15-5350	Tetramethylbiphosphine disulfide, 99% (3676-97-9) (CH ₃) ₂ P(S)P(S)(CH ₃) ₂ ; FW: 186.21; white xtl.; m.p. 224-228°		5g 25g
15-0557 NEW	(11aS)-1,2,10,11-Tetramethyl-4,8-bis(t-butyl)-6-[[[(2S,5S)-(2,5-diphenyl-1-phospholanyl)methoxy]-dibenzo[d,f][1,3,2]dioxaphosphepin]S _{ax} S,S-BOBPHOS (1373349-83-7) C ₄₁ H ₅₀ O ₃ P ₂ ; FW: 652.78; white microxtl. pwdr. <i>moisture sensitive</i> For detailed technical note visit strem.com .		100mg 500mg
15-0506	Tetramethyl 6,6'-bis(diphenylphosphino)-1,1',3,3'-tetrahydro[5,5']biindenyl-2,2',2,2'-tetracarboxylate, 99% (959864-39-2) C ₄₈ H ₄₄ O ₈ P ₂ ; FW: 810.81; white to pale yellow pwdr. Note: Sold under license from NCL for research purposes only. Patent Pending GB 0719134.9 and its international derivatives. For detailed technical note visit strem.com .		100mg 500mg
15-1099 NEW	1,3,5,7-Tetramethyl-8-(2-di-o-tolylphosphino-phenyl)-2,4,6-trioxa-8-phosphaadamantane PAD-Dal-Phos (1902911-38-9) C ₃₀ H ₃₄ O ₃ P ₂ ; FW: 504.54; white pwdr. <i>air sensitive, moisture sensitive</i>		250mg 1g
15-5355	1,3,5,7-Tetramethyl-8-phenyl-2,4,6-trioxa-8-phosphaadamantane, 99% MeCgPPh (97739-46-3) C ₁₆ H ₂₁ O ₃ P; FW: 292.31; white pwdr.; m.p. 107-109° <i>air sensitive, moisture sensitive</i> For detailed technical note visit strem.com .		500mg 2g

PHOSPHORUS (Compounds)

15-5360	Tetramethylphosphonium bromide, 98% (4519-28-2) (CH ₃) ₄ P ⁺ Br ⁻ ; FW: 171.02; colorless xtl. <i>hygroscopic</i>	1g 5g
15-1322	Tetraoctylphosphonium bromide, min. 95% (23906-97-0) See page 83	
15-5450	Tetraphenylphosphonium bromide, 99% (2751-90-8) (C ₆ H ₅) ₄ P ⁺ Br ⁻ ; FW: 419.30; white xtl.; m.p. 294-296° <i>hygroscopic</i>	5g 25g 100g
93-1591 HAZ	Thiophosphoryl chloride, 98% (3982-91-0) PSCl ₃ ; FW: 169.40; colorless liq.; m.p. -35°; b.p. 125°; d. 1.668 <i>moisture sensitive</i>	100g 500g
15-5600	p-Tolyldiphenylphosphine, min. 96% (1031-93-2) (p-CH ₃ C ₆ H ₄) ₂ (C ₆ H ₅) ₂ P; FW: 276.32; white xtl.; m.p. 64-66°	25g 100g
15-5700 amp HAZ	Triallylphosphine, min. 97% (16523-89-0) (CH ₂ =CHCH ₂) ₃ P; FW: 154.19; colorless to pale yellow liq.; b.p. 69°/13 mm; d. 0.861 <i>air sensitive</i>	1g 5g
93-1556	Tri-n-amylophosphate, min. 97% (2528-38-3) (C ₆ H ₁₁ O) ₃ P(O); FW: 308.40; colorless liq.	25g 100g
15-5710	1,3,5-Triaza-7-phosphaadamantane, min. 97% PTA (53597-69-6) C ₆ H ₁₂ N ₃ P; FW: 157.15; white xtl. For detailed technical note visit strem.com .	1g 5g
15-5730	Tribenzylphosphine, 98% (7650-89-7) (C ₆ H ₅ CH ₂) ₃ P; FW: 304.37; white powdr.; m.p. 96-101° <i>air sensitive</i>	1g 5g
		
15-1330	Tributyl(ethyl)phosphonium diethylphosphate, 95% (20445-94-7) See page 83	
15-1327	Tributyl(methyl)phosphonium methylsulfate, min. 95% (69056-62-8) See page 83	
15-1324	Tri-i-butyl(methyl)phosphonium tosylate, min. 95% (374683-35-9) See page 83	
15-5750 HAZ	Tri-i-butylphosphine, min. 93% (4125-25-1) (i-C ₄ H ₉) ₃ P; FW: 202.32; colorless to light yellow liq.; b.p. 85°/7mm <i>air sensitive</i>	25g 100g
15-5801 HAZ 	Tri-n-butylphosphine, min. 93% (998-40-3) (n-C ₄ H ₉) ₃ P; FW: 202.32; colorless to light yellow liq.; b.p. 110-115°/10-12 mm; f.p. 99°F; d. 0.817 <i>pyrophoric</i>	100g 500g
15-5813 HAZ 	Tri-t-butylphosphine, min. 98% (13716-12-6) (t-C ₄ H ₉) ₃ P; FW: 202.32; colorless liq. to white solid; m.p. 30°; b.p. 102-103°/13 mm; f.p. 1°F; d. 0.812 <i>pyrophoric</i>	1g 5g
15-5818	Tri-t-butylphosphine, min. 98% (50wt% in toluene) (13716-12-6) C ₁₂ H ₂₇ P; FW: 202.32; colorless liq. <i>air sensitive</i>	2g 10g
15-5800 HAZ 	Tri-n-butylphosphine, 99% (998-40-3) (n-C ₄ H ₉) ₃ P; FW: 202.32; colorless liq.; b.p. 110-115°/10-12 mm; f.p. 99°F; d. 0.817 <i>pyrophoric</i>	25g 100g 500g
15-5802 HAZ	Tri-n-butylphosphine, 99% (10 wt% in hexanes) (998-40-3) (n-C ₄ H ₉) ₃ P; FW: 202.32; colorless liq. <i>air sensitive</i>	250g 1kg



PHOSPHORUS (Compounds)

15-5810 amp HAZ 	Tri-<i>t</i>-butylphosphine, 99% (13716-12-6) ($t\text{-C}_4\text{H}_9$) ₃ P; FW: 202.32; colorless liq. to white solid; m.p. 30°; b.p. 102-103°/13 mm; f.p. 1°F; d. 0.812 <i>pyrophoric</i> For detailed technical note visit strem.com .	1g 5g 25g
15-5811 HAZ	Tri-<i>t</i>-butylphosphine, 99% (10 wt% in hexanes) (13716-12-6) ($t\text{-C}_4\text{H}_9$) ₃ P; FW: 202.32; colorless liq.; d. 0.680 <i>air sensitive</i> For detailed technical note visit strem.com .	10g 50g
15-5812 HAZ	Tri-<i>t</i>-butylphosphine, 99% (10 wt% in hexanes) (Sure/Seal™ bottle) (13716-12-6) ($t\text{-C}_4\text{H}_9$) ₃ P; FW: 202.32; colorless liq.; d. 0.680 <i>air sensitive</i> For detailed technical note visit strem.com .	50g
15-5950	Tri-<i>n</i>-butylphosphite, min. 94% (102-85-2) ($n\text{-C}_4\text{H}_9\text{O}$) ₃ P; FW: 250.32; colorless liq.; b.p. 121-125°/6 mm; f.p. 197°F; d. 0.925 <i>air sensitive</i>	250g 1kg
15-5990	Tri-<i>n</i>-butylphosphonium tetrafluoroborate, 99% (113978-91-9) [(C_4H_9) ₃ PH] ⁺ BF ₄ ⁻ ; FW: 290.13; white powdr.; m.p. 51-52° For detailed technical note visit strem.com .	1g 5g
15-6000	Tri-<i>t</i>-butylphosphonium tetrafluoroborate, 99% (131274-22-1) [(C_4H_9) ₃ PH] ⁺ BF ₄ ⁻ ; FW: 290.13; white powdr.; m.p. 261° dec. Note: Phosphine Ligand Kit component. For detailed technical note visit strem.com .	1g 5g 25g
15-6010	Tri-<i>t</i>-butylphosphonium trifluoromethanesulfonate, 99% Stabiphos T (1106696-25-6) [(C_4H_9) ₃ PH] ⁺ CF ₃ SO ₃ ⁻ ; FW: 352.40; white solid; m.p. 175°	1g 5g
15-6020	2,8,9-Tri-<i>i</i>-butyl-2,5,8,9-tetraaza-1-phosphabicyclo[3.3.3]undecane, 97% (331465-71-5) C ₁₈ H ₃₉ N ₄ P; FW: 342.50; cloudy yellow liq.; d. 0.964 <i>air sensitive, moisture sensitive</i> For detailed technical note visit strem.com .	250mg 1g 5g
15-5960	Tributyl(tetradecyl)phosphonium dodecylbenzenesulfonate, min. 98% CYPHOS® IL 201 See page 83	
15-5970	Tributyl(tetradecyl)phosphonium methanesulfonate, min. 98% CYPHOS® IL 203 See page 83	
15-6030	Tri(<i>m</i>-chlorophenyl)phosphine, min. 97% (29949-85-7) ($m\text{-ClC}_6\text{H}_4$) ₃ P; FW: 365.63; white xtl.; m.p. 64-66° <i>air sensitive, (store cold)</i>	1g 5g
15-6050	Tri(<i>p</i>-chlorophenyl)phosphine, 99% (1159-54-2) ($p\text{-ClC}_6\text{H}_4$) ₃ P; FW: 365.63; white xtl.; m.p. 90-93°	1g 5g
15-6151 HAZ	Tricyclohexylphosphine (20% in toluene), min. 88% (2622-14-2) (C_6H_{11}) ₃ P; FW: 280.44; colorless to light yellow liq.; f.p. 40°F (toluene); d. 0.9 <i>air sensitive</i>	100g 500g
15-6150	Tricyclohexylphosphine, 97% (2622-14-2) (C_6H_{11}) ₃ P; FW: 280.44; white xtl.; m.p. 76-78° <i>air sensitive</i>	5g 25g 250g
15-6160	Tricyclohexylphosphonium tetrafluoroborate, 99% (58656-04-5) [(C_6H_{11}) ₃ PH] ⁺ BF ₄ ⁻ ; FW: 368.24; white powdr.	1g 5g 25g







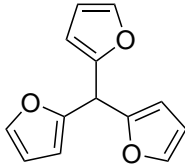

Technical Note:

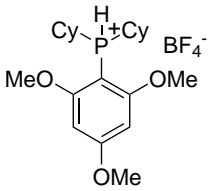
1. Non-pyrophoric, air-stable derivative suitable as a replacement for the neat phosphine in a variety of stoichiometric and catalytic processes.

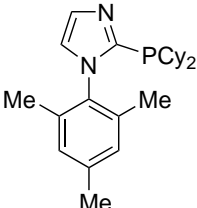

PHOSPHORUS (Compounds)

15-6130	Tricyclohexylphosphonium trifluoromethanesulfonate, 99% Stabiphos (952649-12-6) [(C ₆ H ₁₁) ₃ PH] ⁺ CF ₃ SO ₃ ⁻ ; FW: 430.51; white solid	1g 5g
15-6180 amp HAZ 	Tricyclopentylphosphine, min. 95% (7650-88-6) (C ₅ H ₉) ₃ P; FW: 238.35; colorless liq. <i>pyrophoric</i>	1g 5g
15-6181 HAZ	Tricyclopentylphosphine, min. 95% (10wt% in hexanes) (7650-88-6) (C ₅ H ₉) ₃ P; FW: 238.35; colorless liq. <i>air sensitive</i>	10g 50g
93-1559	Triethylphosphate, 99% (78-40-0) (C ₂ H ₅ O) ₃ PO; FW: 182.16; colorless liq.; m.p. -56.4°; b.p. 215°; f.p. 240°F; d. 1.072	500g 4 x 500g
15-6300 amp HAZ 	Triethylphosphine, 99% (554-70-1) (C ₂ H ₅) ₃ P; FW: 118.16; colorless liq.; b.p. 126-128°; f.p. 1°F; d. 0.81 <i>pyrophoric</i>	5g 25g
15-6302 HAZ 	Triethylphosphine, 99% (Sure/Seal™ bottle) (554-70-1) (C ₂ H ₅) ₃ P; FW: 118.16; colorless liq.; b.p. 126-128°; f.p. 1°F; d. 0.81 <i>pyrophoric</i>	25g
15-6304 HAZ	Triethylphosphine, 99% (20 wt% in ethanol) (554-70-1) (C ₂ H ₅) ₃ P; FW: 118.16; colorless liq. <i>air sensitive</i>	25g 125g
15-6305 HAZ	Triethylphosphine, 99% (10 wt% in hexanes) (554-70-1) (C ₂ H ₅) ₃ P; FW: 118.16; colorless liq. <i>air sensitive</i>	50g 250g
15-6310	Triethylphosphine oxide, 98% (597-50-2) (C ₂ H ₅) ₃ PO; FW: 134.16; white xtl.; m.p. 52-53°; b.p. 84-85°/3 mm <i>hygroscopic</i>	1g 5g
15-6350 HAZ	Triethylphosphite, 98% (122-52-1) (C ₂ H ₅ O) ₃ P; FW: 166.16; colorless liq.; b.p. 156°; f.p. 130°F; d. 0.969 <i>air sensitive</i>	250g 1kg
15-6355	Triethylphosphonium tetrafluoroborate, 99% [(C ₂ H ₅) ₃ PH] ⁺ BF ₄ ⁻ ; FW: 205.97; white pwdr. <i>hygroscopic</i>	1g 5g
Technical Note:		
1. Non-pyrophoric, air-stable derivative suitable as a replacement for the neat phosphine in a variety of stoichiometric and catalytic processes.		
15-6372	Tri-2-furylphosphine, 98+% (5518-52-5) (C ₄ H ₃ O) ₃ P; FW: 232.17; white pwdr.; m.p. 63-65°; b.p. 136°/4mm <i>air sensitive</i> Note: Phosphine Ligand Kit component. For detailed technical note visit strem.com .	500mg 2g 5g
		
15-1312	Tri-n-hexylphosphine, min. 96% (4168-73-4) C ₁₈ H ₃₉ P; FW: 286.48; colorless liq.; b.p. 227° (50mm); d. 0.818 <i>air sensitive</i>	5g 25g
15-1337 HAZ	Tri-n-hexylphosphine oxide/tri-n-octylphosphine oxide, min. 92% [mixture R3P(O), R2R'P(O), RR'2P(O), R'3P(O)] (100786-00-3) colorless, viscous liq.; b.p. 310° (50mm); f.p. 182° C; d. 0.88	5g 25g
15-6370	Trihexyl(tetradecyl)phosphonium bis(trifluoromethanesulfonyl)amide, min. 97% CYPHOS® IL 109 (460092-03-9) See page 83	

PHOSPHORUS (Compounds)

15-6374	Trihexyl(tetradecyl)phosphonium bis(2,4,4-trimethylpentyl)phosphinate, min. 95% CYPHOS® IL 104 (465527-59-7) See page 83	
15-6378	Trihexyl(tetradecyl)phosphonium bromide, min. 95% CYPHOS® IL 102 (654057-97-3) See page 84	
15-6382	Trihexyl(tetradecyl)phosphonium chloride, min. 93% CYPHOS® IL 101 (258864-54-9) See page 84	
15-6386	Trihexyl(tetradecyl)phosphonium decanoate, min. 95% CYPHOS® IL 103 (465527-65-5) See page 84	
15-6390	Trihexyl(tetradecyl)phosphonium dicyanamide, min. 95% CYPHOS® IL 105 See page 84	
15-6394	Trihexyl(tetradecyl)phosphonium hexafluorophosphate, min. 98% CYPHOS® IL 110 (374683-44-0) See page 84	
15-6520	[2,4,6-Trimethoxyphenyl]dicyclohexylphosphonium tetrafluoroborate, 98% LB-PhosHBF₄ (1217887-12-1) C ₂₁ H ₃₄ BF ₄ O ₃ P; FW: 452.27; white solid; m.p. 142.6-143.4° Note: Sold under license from ZJU for research purposes only. Patents ZL200910154029.4, PCT/CN2009/001527 For detailed technical note visit strem.com .	500mg 2g
NEW		
15-6360	2,4,4-Trimethylpentylphosphine, 99% (8% isomers) (82164-75-8) CH ₃ C(CH ₃) ₂ CH ₂ CH(CH ₃)CH ₂ PH ₂ ; FW: 146.21; colorless liq.; f.p. 1°F <i>air sensitive, pyrophoric</i>	5g 25g
HAZ		
15-6362	1-(2,4,6-Trimethylphenyl)-2-(dicyclohexylphosphino)imidazole, min. 95% [cataCXium® PICy] (794527-14-3) C ₂₄ H ₃₅ N ₂ P; FW: 382.52; white powdr.; m.p. 109° <i>air sensitive</i> Note: Sold in collaboration with Solvias for research purposes only. Patent Application pending. Solvias cataCXium® Ligand Kit component. For detailed technical note visit strem.com .	500mg 2g
		
15-6365	Trimethylphenylphosphonium iodide, min. 97% (1006-01-5) (CH ₃) ₃ C ₆ H ₅ PI; FW: 280.09; white xtl.; m.p. 218° <i>hygroscopic</i>	5g 25g
93-1561	Trimethylphosphate, min. 97% (512-56-1) (CH ₃ O) ₃ P(O); FW: 140.08; colorless liq.; m.p. -46°; b.p. 197°; d. 1.197	50g 250g
15-6500	Trimethylphosphine, min. 98% (594-09-2) (CH ₃) ₃ P; FW: 76.08; colorless liq.; m.p. -85°; b.p. 38-40°; f.p. -22°F; d. 0.748 <i>air sensitive, STENCH</i>	5g 25g
HAZ		
15-6502	Trimethylphosphine, min. 98% (Sure/Seal™ bottle) (594-09-2) (CH ₃) ₃ P; FW: 76.08; colorless liq.; m.p. -85°; b.p. 38-40°; f.p. -22°F; d. 0.748 <i>air sensitive, STENCH</i>	25g
HAZ		
15-6550	Trimethylphosphite, 97% (121-45-9) (CH ₃ O) ₃ P; FW: 124.08; colorless liq.; b.p. 110-112°; f.p. 82°F; d. 1.052 <i>air sensitive, moisture sensitive</i>	250g 1kg
HAZ		
15-6558	Trimethylphosphite, 99% (121-45-9) (CH ₃ O) ₃ P; FW: 124.08; colorless liq.; b.p. 110-112°; f.p. 82°F; d. 1.052 <i>air sensitive</i>	50g 250g
NEW		
HAZ		
15-6560	Trimethylphosphonium tetrafluoroborate, 99% (154358-50-6) (CH ₃) ₃ PH ⁺ BF ₄ ⁻ ; FW: 163.89; white powdr. <i>hygroscopic</i> For detailed technical note visit strem.com .	1g 5g

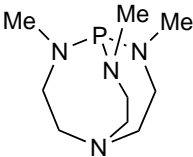
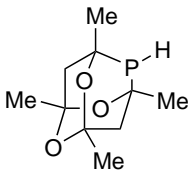
PHOSPHORUS (Compounds)

15-6400	2,8,9-Trimethyl-2,5,8,9-tetraaza-1-phosphabicyclo[3.3.3]undecane VERKADE SUPERBASE (120666-13-9) $C_9H_{23}N_4P$; FW: 216.26; white waxy solid; m.p. 110-115° <i>moisture sensitive, (store cold)</i> For detailed technical note visit strem.com .		250mg 1g
15-6610	Tri(1-naphthyl)phosphine, min. 98% (3411-48-1) $(1-C_{10}H_7)_3P$; FW: 412.47; white powdr.; m.p. 265-268°		1g 5g
15-6620	Tri-neo-pentylphosphite, min. 90% (14540-52-4) $[(CH_3)_3CCH_2O]_3P$; FW: 292.40; white xtl.; m.p. 55-57°; b.p. 80°/0.15 mm <i>air sensitive</i>		1g 5g
15-6655 HAZ	Tri-n-octylphosphine, min. 97% TOP (4731-53-7) $(C_8H_{17})_3P$; FW: 370.60; colorless to pale yellow liq.; m.p. 30°; b.p. 175°/0.3mm; f.p. 280°F; d. 0.83 <i>air sensitive</i> Note: Surfactant for nanomaterial synthesis.		25g 100g 500g
15-6660 HAZ	Trioctylphosphine oxide, min. 90% TOPO (78-50-2) $(n-C_8H_{17})_3PO$; FW: 386.65; off-white xtl.; m.p. 51-52°; f.p. >230°F; d. 0.88 <i>hygroscopic</i> Note: Surfactant for nanomaterial synthesis.		100g 500g
15-6661 HAZ	Trioctylphosphine oxide, 99% TOPO (78-50-2) $(n-C_8H_{17})_3PO$; FW: 386.65; white to off-white solid; m.p. 51-52°; f.p. >230°F; d. 0.88 <i>hygroscopic</i> Note: Surfactant for nanomaterial synthesis.		25g 100g
15-1310 HAZ	2,4,6-Trioxa-1,3,5,7-tetramethyl-8-phosphaadamantane (~32% in xylene) (26088-25-5) $C_{10}H_{17}O_3P$; FW: 216.21; colorless liq. <i>air sensitive</i>		5g 25g
93-1562 HAZ	Triphenylphosphate, 98% (115-86-6) $(C_6H_5O)_3P(O)$; FW: 326.28; white xtl.; m.p. 49-51°; b.p. 244°/10 mm; f.p. 428°F		500g
15-6700	Triphenylphosphine, 99% (603-35-0) $(C_6H_5)_3P$; FW: 262.28; white xtl.; m.p. 79°; b.p. 360°; f.p. 359°F		100g 500g 2kg
15-6750	Triphenylphosphine oxide, 98% (791-28-6) $(C_6H_5)_3PO$; FW: 278.28; white xtl.; m.p. 151-154°; f.p. 356°F; d. 1.212		25g 100g
15-6730	Triphenylphosphine, polymer-bound, on styrene-divinylbenzene copolymer (20% cross-linked) $(C_6H_5)_3P$; off-white beads, 20-60 mesh <i>air sensitive</i>		1g 5g 25g
15-6850	Triphenylphosphite, 97% (101-02-0) $(C_6H_5O)_3P$; FW: 310.28; colorless to yellow, low melting solid; m.p. 22-24°; b.p. 360°; f.p. 425°F; d. 1.180-1.186		500g 2kg
15-6949 amp HAZ 	Tri-i-propylphosphine, tech. gr., min. 90% (6476-36-4) $(i-C_3H_7)_3P$; FW: 160.24; colorless liq.; b.p. 176-178°; d. 0.82 <i>pyrophoric</i>		1g 5g 25g
15-6950 amp HAZ 	Tri-i-propylphosphine, 98% (6476-36-4) $(i-C_3H_7)_3P$; FW: 160.24; colorless liq.; b.p. 176-178°; d. 0.82 <i>pyrophoric</i>		1g 5g 25g

PHOSPHORUS (Compounds)

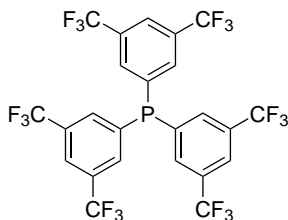
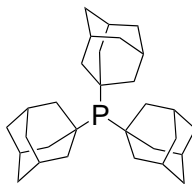
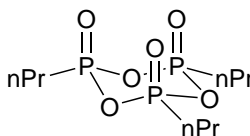
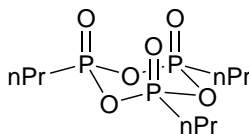
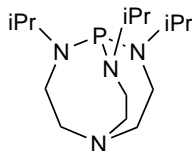

15-6952 HAZ 	Tri-<i>i</i>-propylphosphine, 98% (Sure/Seal™ bottle) (6476-36-4) (<i>i</i> -C ₃ H ₇) ₃ P; FW: 160.24; colorless liq.; b.p. 176-178°; d. 0.82 <i>pyrophoric</i>	25g
15-6954 HAZ	Tri-<i>i</i>-propylphosphine, 98% (10 wt% in hexanes) (6476-36-4) (<i>i</i> -C ₃ H ₇) ₃ P; FW: 160.24; colorless liq. <i>air sensitive</i>	10g 50g 250g
15-7050 amp HAZ	Tri-<i>n</i>-propylphosphine, min. 95% (2234-97-1) (<i>n</i> -C ₃ H ₇) ₃ P; FW: 160.24; colorless liq.; b.p. 185-188°; f.p. 144°F; d. 0.807 <i>air sensitive</i>	10g 50g
15-7070	Tri-<i>n</i>-propylphosphine oxide, min. 98% (1496-94-2) (<i>n</i> -C ₃ H ₇) ₃ PO; FW: 176.24; white xtl.; m.p. 39°; b.p. 280-282° <i>moisture sensitive</i>	1g 5g
15-7000 HAZ	Tri-<i>i</i>-propylphosphite, min. 94% (116-17-6) [(CH ₃) ₂ CHO] ₃ P; FW: 208.24; colorless liq.; b.p. 63-64°/11 mm; f.p. 154°F; d. 0.844 <i>air sensitive</i>	50g 250g
15-7200	2,8,9-Tri-<i>i</i>-propyl-2,5,8,9-tetraaza-1-phosphabicyclo[3.3.3]undecane (175845-21-3) C ₁₅ H ₃₃ N ₄ P; FW: 300.42; yellow liq.; f.p. 185°F; d. 0.922 <i>moisture sensitive</i> For detailed technical note visit strem.com .	250mg 1g
15-9159 HAZ	2,4,6-Tri-<i>n</i>-propyl-2,4,6-trioxo-1,3,5,2,4,6-trioxatriphosphorinane (Propylphosphonic acid anhydride 50% solution in N,N-dimethylformamide) T3P (68957-94-8) (C ₃ H ₇ O ₂ P) ₃ ; FW: 318.20; slightly yellow to brown liq. <i>moisture sensitive</i> For detailed technical note visit strem.com .	10g 50g
15-9160 HAZ	2,4,6-Tripopyl-2,4,6-trioxo-1,3,5,2,4,6-trioxatriphosphorinane T3P (Propylphosphonic acid anhydride 50% solution in ethyl acetate) (68957-94-8) (C ₃ H ₇ O ₂ P) ₃ ; FW: 318.20; slightly yellow to brown liq. <i>moisture sensitive</i>	10g 50g
15-0935 NEW	Tris(1-adamantyl)phosphine, 97% (897665-73-5) C ₃₀ H ₄₅ P; FW: 436.65; white to off-white pwdr. <i>air sensitive</i> Note: Sold in collaboration with GreenCentre for re-search purposes only. Patents: 62248056. For detailed technical note visit strem.com .	250mg 1g 5g
15-9165	Tris[3,5-bis(trifluoromethyl)phenyl]phosphine, 97% (175136-62-6) C ₂₄ H ₉ F ₁₈ P; FW: 670.37; brown solid	250mg 1g 5g

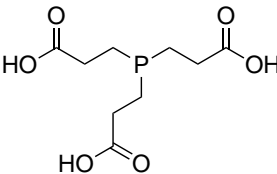
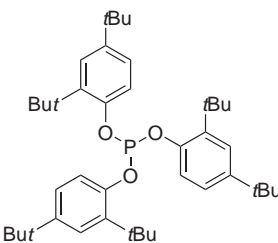
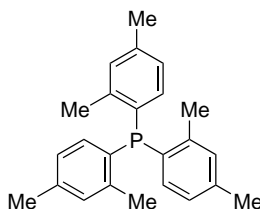
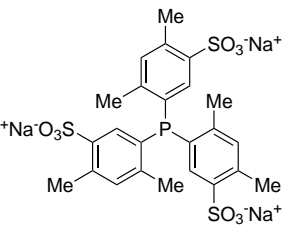

PHOSPHORUS (Compounds)

15-7400	Tris(2-carboxyethyl)phosphine, hydrochloride, 99% TCEP (51805-45-9) (HOOCCH ₂ CH ₂) ₃ PH ⁺ Cl ⁻ ; FW: 286.65; white xtl.		1g 5g
93-1564	Tris(2-chloroethyl)phosphate, 97% (115-96-8) (ClCH ₂ CH ₂ O) ₃ P(O); FW: 285.52; colorless liq.; m.p. -51°; b.p. 330°; f.p. 450°F; d. 1.39		500g 2kg
15-7680	Tris(2-cyanoethyl)phosphine, min. 99% (4023-53-4) P(CH ₂ CH ₂ CN) ₃ ; FW: 193.19; white xtl.; m.p. 97-98°; b.p. 235°/0.9 mm		5g 25g
15-7720	Tris(2,4-di-t-butylphenyl)phosphite, 98% (31570-04-4) [(CH ₃) ₃ C] ₂ C ₆ H ₃ O] ₃ P; FW: 646.93; white powdr.; m.p. 181-184° <i>moisture sensitive</i> Note: Phosphine Ligand Kit component. For detailed technical note visit strem.com .		10g 250g 1kg
15-7725	Tris(2,6-dimethoxyphenyl)phosphine, min. 97% (85417-41-0) C ₂₄ H ₂₇ O ₆ P; white to off-white powdr.; m.p. 145-147° <i>air sensitive</i>		5g
15-7800	Tris(dimethylamino)phosphine, min. 98% HMPT (1608-26-0) [(CH ₃) ₂ N] ₃ P; FW: 163.21; yellow liq.; b.p. 49-51°/12 mm; f.p. 98°F; d. 0.898 HAZ <i>air sensitive, moisture sensitive</i>		1g 5g
15-7830	Tris(2,4-dimethylphenyl)phosphine, 98% (49676-42-8) [(CH ₃) ₂ C ₆ H ₃] ₃ P; FW: 346.45; white powdr.; m.p. 157-158°		500mg 2g
15-7820	Tris(3,5-dimethylphenyl)phosphine, 98% (69227-47-0) [(CH ₃) ₂ C ₆ H ₃] ₃ P; FW: 346.45; white xtl.; m.p. 160-163°		500mg 2g
15-7860	Tris(4,6-dimethyl-3-sulfonatophenyl)phosphine trisodium salt hydrate, min. 97% TXPTS (443150-11-6) [(CH ₃) ₂ (C ₆ H ₂)SO ₃ Na] ₃ P·XH ₂ O; FW: 652.58; white powdr. For detailed technical note visit strem.com .		250mg 1g
15-7888	Tris[2-(diphenylphosphino)ethyl]phosphine, 98% PP₃ (23582-03-8) C ₄₂ H ₄₂ P ₄ ; FW: 670.68; white powdr. For detailed technical note visit strem.com .		250mg 1g
15-7880	1,1,1-Tris(diphenylphosphino)methane, 97% (28926-65-0) HC[P(C ₆ H ₅) ₂] ₃ ; FW: 568.58; white xtl.; m.p. 168-172°		1g 5g
15-7870	1,1,1-Tris(diphenylphosphinomethyl)ethane, min. 97% TRIPHOS (22031-12-5) CH ₃ C[CH ₂ P(C ₆ H ₅) ₂] ₃ ; FW: 624.68; white powdr.; m.p. 98-101°		1g 5g
15-7890	Tris(p-fluorophenyl)phosphine, 99% (18437-78-0) (p-FC ₆ H ₄) ₃ P; FW: 316.27; off-white xtl.; m.p. 80-81°		1g 5g

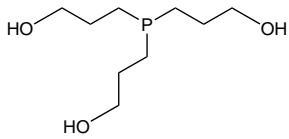
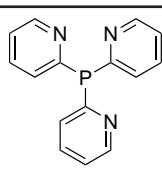
PHOSPHORUS (Compounds)

15-7900 HAZ	Tris(hydroxymethyl)phosphine, min. 85% (2767-80-8) P(CH ₂ OH) ₃ ; FW: 124.08; colorless solid to viscous liq. <i>air sensitive</i>	1g 5g
15-7901 HAZ	Tris(hydroxymethyl)phosphine, min. 95% (2767-80-8) P(CH ₂ OH) ₃ ; FW: 124.08; colorless to pale yellow solid <i>air sensitive</i>	250mg 1g
15-6375 amp HAZ	Tris(3-hydroxypropyl)phosphine, min. 80% (4706-17-6) (HOC ₃ H ₆) ₃ P; FW: 208.24; viscous liq. <i>air sensitive</i>	2g 10g 50g
		
15-7940	Tris(4-methoxy-3,5-dimethylphenyl)phosphine, min. 98% (121898-64-4) [(CH ₃) ₂ (OCH ₃)C ₆ H ₂] ₃ P; FW: 436.52; white xtl.; m.p. 175-177°	1g 5g
15-7975	Tris(m-methoxyphenyl)phosphine, 97+% (29949-84-6) (m-CH ₃ OC ₆ H ₄) ₃ P; FW: 352.37; white xtl.; m.p. 115°	1g 5g
15-7950	Tris(o-methoxyphenyl)phosphine, min. 98% (4731-65-1) (o-CH ₃ OC ₆ H ₄) ₃ P; FW: 352.37; white xtl.; m.p. 203-205°	1g 5g
15-8000	Tris(p-methoxyphenyl)phosphine, 98% (855-38-9) (p-CH ₃ OC ₆ H ₄) ₃ P; FW: 352.37; white to pale yellow xtl.; m.p. 132-135°	1g 5g
15-8005	Tris(pentafluorophenyl)phosphine, 98% (1259-35-4) (C ₆ F ₅) ₃ P; FW: 532.15; white powdr.; m.p. 117-119°	1g 5g
15-7945 NEW	Tris(2-pyridyl)phosphine, min. 97% (26437-48-9) (C ₅ H ₄ N) ₃ P; FW: 265.25; white to off-white powdr.; m.p. 112-114° <i>air sensitive</i>	250mg 1g
		
15-8013	Tris(3-sulfonatophenyl)phosphine hydrate, sodium salt (<5% oxide) (63995-70-0) Na ₃ P(C ₆ H ₄ SO ₃) ₃ ·XH ₂ O; FW: 568.40; white to off-white powdr.	250mg 1g
15-8007	Tris(3-sulfonatophenyl)phosphine hydrate, sodium salt (<10% oxide) (63995-70-0) Na ₃ P(C ₆ H ₄ SO ₃) ₃ ·XH ₂ O; FW: 568.40; white to off-white powdr.	250mg 1g 5g
15-8010	Tris(p-trifluoromethylphenyl)phosphine, min. 97% (13406-29-6) (p-CF ₃ C ₆ H ₄) ₃ P; FW: 466.28; pale yellow powdr.; m.p. 73-75°	1g 5g
15-8015	Tris(2,4,6-trimethoxyphenyl)phosphine, min. 97% (91608-15-0) [(CH ₃ O) ₃ C ₆ H ₂] ₃ P; FW: 532.54; light yellow powdr.; m.p. 155-160° <i>air sensitive</i>	2g 10g
15-8017	Tris(2,4,6-trimethylphenyl)phosphine, 98% (23897-15-6) [(CH ₃) ₃ C ₆ H ₂] ₃ P; FW: 388.53; white powdr.; m.p. 185°	1g 5g
15-8020 amp HAZ 	Tris(trimethylsilyl)phosphine, min. 98% (15573-38-3) [(CH ₃) ₃ Si] ₃ P; FW: 250.54; colorless to pale yellow, low melting solid; m.p. 24°; b.p. 102-105°/16 mm; f.p. -1°F; d. 0.863 <i>pyrophoric</i>	250mg 1g 5g
15-8021 HAZ	Tris(trimethylsilyl)phosphine, min. 98% (10 wt% in hexanes) (15573-38-3) [(CH ₃) ₃ Si] ₃ P; FW: 250.54; colorless liq. <i>air sensitive</i>	10g 50g
15-8100	Tri-m-tolylphosphine, 98% (6224-63-1) (m-CH ₃ C ₆ H ₄) ₃ P; FW: 304.37; white xtl.; m.p. 100° <i>air sensitive</i>	5g 25g
15-8120	Tri-p-tolylphosphine, 98% (1038-95-5) (p-CH ₃ C ₆ H ₄) ₃ P; FW: 304.37; white xtl.; m.p. 145-148° <i>air sensitive</i>	5g 25g

PHOSPHORUS (Compounds)

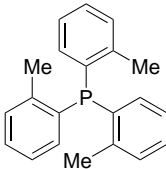
15-8050	Tri-o-tolylphosphine, 99% (6163-58-2) (o-CH ₃ C ₆ H ₄) ₃ P; FW: 304.37; white xtl.; m.p. 125-128° <i>air sensitive</i> Note: Phosphine Ligand Kit component.		5g 25g
96-3740	UREAphos and METAMORPhos Ligand Kit for Asymmetric Hydrogenation See page 529		
15-9150 amp	Vinyldiphenylphosphine, min. 97% (2155-96-6) (CH ₂ =CH)(C ₆ H ₅) ₂ P; FW: 212.23; colorless to yellow liq.; b.p. 135°/3.5 mm; f.p. >230°F; d. 1.067 <i>air sensitive, (store cold)</i>		1g 5g 25g
15-9155 HAZ	Vinylphosphonic acid, min. 90% (1746-03-8) CH ₂ =CHP(O)(OH) ₂ ; FW: 108.00; colorless to pale-yellow liq.; m.p. 36°		50g 250g
15-9158 HAZ	Vinylphosphonic acid dimethyl ester, min. 90% (4645-32-3) CH ₂ =CHP(O)(OCH ₃) ₂ ; FW: 136.10; colorless liq. <i>(store cold)</i>		50g 250g

PLATINUM (Elemental Forms)

96-6717	BASF Heterogeneous Catalyst Kit See page 467		
96-6721	BASF Platinum Catalyst Kit See page 468		
78-1685 HAZ	Dealloyed Pt-Co core-shell fuel cell catalyst on carbon PtCo; black solid		100mg
78-1688 HAZ	Dealloyed Pt-Cu core-shell fuel cell catalyst on carbon PtCu; black solid		100mg
96-6674	Evonik Heterogeneous Catalyst Kit for Selective Hydrogenation See page 484		
78-0007	Platinum, 97% (2-5 nanometers) (7440-06-4) See page 163		
78-1630	Platinum, 0.8% on activated carbon, 50% water-wet paste (NanoSelect Pt-100) (7440-06-4) Pt; black solid (d50=25µm) Note: Sold in collaboration with BASF for research purposes only.		5g 25g
78-1540	Platinum, 3% on activated carbon, sulfided (50-70% wetted powder) Evonik Noblyst® P2065 (7440-06-4) wetted, black pwdr. Note: Sold in collaboration with Evonik for research purposes only. Evonik Heterogeneous Catalyst Kit component. Evonik Heterogeneous Catalyst Kit for Selective Hydrogenation component.		10g 50g
78-1600 HAZ	Platinum, 5% on activated carbon (7440-06-4) Pt; pwdr.; SA: ~1023 m ² /g; b.p. 3827° (Pt); P.Vol. 0.79 cc/g; d. 21.45		10g 50g
78-1530	Platinum, 5% on activated carbon (50-70% wetted powder) Evonik Noblyst® P2058 (7440-06-4) wetted, black pwdr. Note: Sold in collaboration with Evonik for research purposes only. Evonik Heterogeneous Catalyst Kit component. Evonik Heterogeneous Catalyst Kit for Selective Hydrogenation component.		10g 50g
78-1534	Platinum, 5% on activated carbon (50-70% wetted powder) Evonik Noblyst® P2060 (7440-06-4) wetted, black pwdr. Note: Sold in collaboration with Evonik for research purposes only. Evonik Heterogeneous Catalyst Kit component. Evonik Heterogeneous Catalyst Kit for Selective Hydrogenation component.		10g 50g

PLATINUM (Elemental Forms)

78-1613	Platinum, 5% on activated carbon, unreduced, 50% water wet paste (Escat™ 2441) (7440-06-4)	5g 25g
	black pwdr. (d50=18 µm); SA: 900m ² /g Note: Sold in collaboration with BASF for research purposes only. BASF Heterogeneous Catalyst Kit component. BASF Platinum Catalyst Kit component.	
Technical Note:		
1. Escat™ 2441 catalyst is recommended for a broad range of reactions common to platinum on carbon catalysts, such as nitro group reductions, reductive alkylations as well as other coupling reactions. Active over a wide range of conditions.		
78-1610	Platinum, 10% on activated carbon (7440-06-4)	1g
HAZ	Pt; pwdr.; SA: ~1000 m ² /g; b.p. 3827° (Pt); P.Vol. 0.79 cc/g; d. 21.45	5g 25g
78-1615	Platinum, 5% on activated peat carbon, reduced, 50% water wet paste (Escat™ 2621) (7440-06-4)	5g 25g
	black pwdr. (d50=15 µm); SA: 850m ² /g Note: Sold in collaboration with BASF for research purposes only.	
Technical Note:		
1. Escat™ 2621 catalyst is recommended for a broad range of reactions common to platinum on carbon catalysts, such as nitro group reductions, reductive alkylations as well as other coupling reactions. Active over a wide range of conditions.		
78-1614	Platinum, 3% on activated wood carbon, reduced, 70% water wet paste (Escat™ 2931) (7440-06-4)	5g 25g
	black pwdr. (d50=22 µm); SA: 1500m ² /g Note: Sold in collaboration with BASF for research purposes only. BASF Platinum Catalyst Kit component.	
Technical Note:		
1. Escat™ 2931 catalyst is recommended for a broad range of reactions common to platinum on carbon catalysts, such as nitro group reductions, reductive alkylations as well as other coupling reactions. Specifically recommended for the reduction of halonitro aromatics to haloanilines.		
78-1612	Platinum, 5% on activated wood carbon, reduced, 50% water wet paste (Escat™ 2421) (7440-06-4)	5g 25g
	black pwdr. (d50=18 µm); SA: 900m ² /g Note: Sold in collaboration with BASF for research purposes only. BASF Heterogeneous Catalyst Kit component. BASF Platinum Catalyst Kit component.	
Technical Note:		
1. Escat™ 2421 catalyst is recommended for a broad range of reactions common to platinum on carbon catalysts, such as nitro group reductions, reductive alkylations as well as other coupling reactions. Active over a wide range of conditions.		
78-1611	Platinum, 5% on activated wood carbon, reduced, dry (Escat™ 2431) (7440-06-4)	5g 25g
HAZ	black pwdr. (d50=18 µm); SA: 900m ² /g Note: Sold in collaboration with BASF for research purposes only. BASF Heterogeneous Catalyst Kit component. BASF Platinum Catalyst Kit component.	
Technical Note:		
1. Escat™ 2431 catalyst is recommended for a broad range of reactions common to platinum on carbon catalysts, where water is detrimental to the selectivity of the reaction. Active over a wide range of conditions.		
78-1640	Platinum, 0.5% on alumina (7440-06-4)	25g 100g
	Pt; 1/8" x 1/8" pellets; SA: ~100 m ² /g; m.p. 1769° (Pt); b.p. 3827° (Pt); P.Vol. 0.40 cc/g; d. 21.45	
78-1660	Platinum, 5% on alumina (7440-06-4)	10g 50g
	Pt; pwdr.; SA: 80-100 m ² /g; m.p. 1769° (Pt); b.p. 3827° (Pt); P.Vol. 0.41 cc/g; d. 21.45	
78-1661	Platinum, 5% on alumina powder, reduced, dry (Escat™ 2941) (7440-06-4)	5g 25g
	gray pwdr. (d50=70 µm); SA: 110m ² /g Note: Sold in collaboration with BASF for research purposes only. BASF Platinum Catalyst Kit component.	
Technical Note:		
1. Escat™ 2941 catalyst is recommended for selective hydrogenation reactions. The particle size of the catalyst is ideal for allowing fast separation from the reaction mixture.		
78-1420	Platinum black, min. 97% (7440-06-4)	250mg
HAZ	Pt; FW: 195.09; black pwdr.; SA: ~24 m ² /g; m.p. 1769°; b.p. 3827°; d. 21.45	1g 5g

PLATINUM (Elemental Forms)

78-1665	Platinum, 5% on calcium carbonate, unreduced, dry (Escat™ 2371) (7440-06-4) black powdr. (d50=3 µm); SA: 7m ² /g Note: Sold in collaboration with BASF for research purposes only.	5g 25g
Technical Note: 1. Escat™ 2371 catalyst is recommended for selective hydrogenation reactions in which other platinum catalysts can lead to over-hydrogenation. Additional dopants can be added for improved performance.		
78-0050	Platinum foil (99.95%) (7440-06-4) Pt; FW: 195.09; 0.004mm thick (~0.05g/25x 25mm); m.p. 1769°; b.p. 3827°; d. 21.45	25 x 25mm 50 x 50mm
78-0005	Platinum foil (99.99%) (7440-06-4) Pt; FW: 195.09; 0.025mm thick (~0.34g/25x 25mm); m.p. 1769°; b.p. 3827°; d. 21.45	25 x 25mm 50 x 50mm
78-1635	Platinum 0.8% and molybdenum 0.3wt% on activated carbon, 50% water-wet paste (Nanoselect Pt-200) (7440-06-4) Pt; black solid (d50=25µm) Note: Sold in collaboration with BASF for research purposes only.	5g 25g
78-3015 NEW	Platinum nanoparticles, 1% on carbon black (surfactant and reactant-free) (7440-06-4) Pt; FW: 195.10; black solid (store cold) Note: Manufactured by laser ablation. Sold in collaboration with Particular® for research purposes only.	5g 25g
78-3020 NEW	Platinum nanoparticles, 5% on carbon black (surfactant and reactant-free) (7440-06-4) Pt; FW: 195.10; black solid (store cold) Note: Manufactured by laser ablation. Sold in collaboration with Particular® for research purposes only.	5g 25g
78-3030 NEW	Platinum nanoparticles, 10% on carbon black (surfactant and reactant-free) (7440-06-4) Pt; FW: 195.10; black solid (store cold) Note: Manufactured by laser ablation. Sold in collaboration with Particular® for research purposes only.	1g 5g
78-3032 NEW	Platinum nanoparticles, 20% on carbon black (surfactant and reactant-free) (7440-06-4) Pt; FW: 195.10; black solid (store cold) Note: Manufactured by laser ablation. Sold in collaboration with Particular® for research purposes only.	1g 5g
78-3035 NEW	Platinum nanoparticles, 30% on carbon black (surfactant and reactant-free) (7440-06-4) Pt; FW: 195.10; black solid (store cold) Note: Manufactured by laser ablation. Sold in collaboration with Particular® for research purposes only.	1g 5g
78-0405	Platinum Nanoparticles [PtNP: 2-3 nm (gum Arabic)] (7440-06-4) See page 163	
	Platinum nanoparticles - surfactant and reactant-free (pure) manufactured via laser ablation (7440-06-4) See page 163	
78-3012 NEW	Platinum nanoparticles, 1% on Titania (anatase) (surfactant and reactant-free) (7440-06-4) Pt; FW: 195.10; gray solid (store cold) Note: Manufactured by laser ablation. Sold in collaboration with Particular® for research purposes only.	5g 25g

PLATINUM (Elemental Forms)

78-3005 NEW	Platinum nanoparticles, 1% on Titania (rutile) (surfactant and reactant-free) (7440-06-4) Pt; FW: 195.10; light gray solid (store cold) Note: Manufactured by laser ablation. Sold in collaboration with Particular® for research purposes only.	5g 25g
78-3026 NEW	Platinum nanoparticles, 10% on Titania (anatase) (surfactant and reactant-free) (7440-06-4) Pt; FW: 195.10; dark gray solid (store cold) Note: Manufactured by laser ablation. Sold in collaboration with Particular® for research purposes only.	1g 5g
78-3023 NEW	Platinum nanoparticles, 10% on Titania (rutile) (surfactant and reactant-free) (7440-06-4) Pt; FW: 195.10; dark gray solid (store cold) Note: Manufactured by laser ablation. Sold in collaboration with Particular® for research purposes only.	1g 5g
93-7830 HAZ	Platinum powder (99.9%) (7440-06-4) Pt; FW: 195.09; -60 mesh; m.p. 1769°; b.p. 3827°; d. 21.45	1g 5g
93-7832 HAZ	Platinum powder (99.9%) (7440-06-4) Pt; FW: 195.09; avg. particle size 0.8-2.5 micron; m.p. 1769°; b.p. 3827°; d. 21.45	1g 5g
93-7833 HAZ	Platinum powder (99.9%) (7440-06-4) Pt; FW: 195.09; avg. particle size 0.27-0.47 micron; m.p. 1769°; b.p. 3827°; d. 21.45	1g 5g
78-1800 HAZ	Platinum powder (99.999%) (7440-06-4) Pt; FW: 195.09; -22 mesh; m.p. 1769°; b.p. 3827°; d. 21.45	500mg 2g
78-1675	Platinum, 5% on silica powder, reduced, dry (Escat™ 2351) (7440-06-4) gray powdr. (d50=40 µm); SA: 400m ² /g Note: Sold in collaboration with BASF for research purposes only.	5g 25g

Technical Note:

1. Escat™ 2351 catalyst is recommended for selective hydrogenation reactions common to platinum catalysts. The silica support enables totally different catalytic reactivity compared to carbon-based catalysts.

78-1900	Platinum sponge (99.8%) (7440-06-4) Pt; FW: 195.09; -20 mesh gran.; m.p. 1769°; b.p. 3827°; d. 21.45	500mg 2g
78-1920 HAZ	Platinum sponge (99.95%) (7440-06-4) Pt; FW: 195.09; bluish-gray powdr.; m.p. 1769°; b.p. 3827°; d. 21.45	1g 5g
78-1536	Platinum 1% and vanadium 2%, on activated carbon (50-70% wetted powder) Evonik Noblyst® P8078 (7440-06-4) wetted, black powdr. Note: Sold in collaboration with Evonik for research purposes only. Evonik Heterogeneous Catalyst Kit component. Evonik Heterogeneous Catalyst Kit for Selective Hydrogenation component.	10g 50g
78-0082	Platinum wire (99.95%) (7440-06-4) Pt; FW: 195.09; 1.0 mm dia. (~0.17g/cm); m.p. 1769°; b.p. 3827°; d. 21.45	5cm 25cm
78-0085	Platinum wire (99.95%) (7440-06-4) Pt; FW: 195.09; 0.5mm dia. (-1.05g/25cm); m.p. 1769°; b.p. 3827°; d. 21.45	5cm 25cm 100cm
78-0075	Platinum wire (99.99+%) (7440-06-4) Pt; FW: 195.09; 0.254mm dia. (~0.277g/25cm); m.p. 1769°; b.p. 3827°; d. 21.45	25cm 100cm
78-0080	Platinum wire (99.99+%) (7440-06-4) Pt; FW: 195.09; 0.127mm dia. (~0.27g/m); m.p. 1769°; b.p. 3827°; d. 21.45	1m 5m
78-0055	Platinum/tetra-n-octylammonium chloride colloid, purified (70-85% Pt) (7440-06-4) See page 162	
78-0062	Platinum-ruthenium/tetra-n-octylammonium chloride colloid (~7 wt% Pt, ~3.5 wt% Ru) (7440-06-4) See page 162	

PLATINUM (Compounds)

93-7801	Ammonium hexachloroplatinate(IV), 99% (16919-58-7) See page 5	
----------------	---	--

PLATINUM (Compounds)

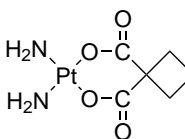
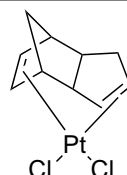
93-7802	Ammonium tetrachloroplatinate(II), 99% (13820-41-2) See page 7	
78-0100	Bis(ethylenediamine)platinum(II) chloride, 99% (21430-85-3) [(NH ₂ CH ₂ CH ₂ NH ₂) ₂ Pt]Cl ₂ ; FW: 386.19; white xtl.; m.p. 300° dec.	1g 5g
78-0140	Bis(tri-<i>t</i>-butylphosphine)platinum (0), 98% (60648-70-6) Pt[(C ₄ H ₉) ₃ P] ₂ ; FW: 599.71; yellow powdr. <i>air sensitive</i>	250mg 1g
78-0200 HAZ	Chloroplatinic acid hexahydrate (38-40% Pt) (99.9%-Pt) (18497-13-7) H ₂ PtCl ₆ ·6H ₂ O; FW: 409.82 (517.92); orange powdr.; m.p. 60° <i>light sensitive, hygroscopic, (store cold)</i>	1g 5g 25g
78-0255	1,1-Cyclobutanedicarboxylatodiammineplatinum(II), 99% CARBOPLATIN (41575-94-4) C ₆ H ₁₂ N ₂ O ₄ Pt; FW: 371.26; white xtl.	250mg 1g 5g
		
78-0295	Diammineplatinum(II) nitrite, solution in ammonium hydroxide (5.0wt% as Pt) (14286-02-3) (NH ₃) ₂ Pt(NO ₂) ₂ ; FW: 321.19; colorless to light yellow liq.	10g 50g
93-7816	Dibromo(1,5-cyclooctadiene)platinum(II), 98% (12145-48-1) Pt(1,5-C ₈ H ₁₂)Br ₂ ; FW: 463.09; white to pale yellow powdr.	1g 5g
78-0360	Dichlorobis(benzonitrile)platinum(II), 99% (14873-63-3) PtCl ₂ (C ₆ H ₅ CN) ₂ ; FW: 472.24; yellow to orange xtl.	250mg 1g 5g
78-0317	cis-Dichlorobis(diethylsulfide)platinum(II), 99% (15442-57-6) Pt[(C ₂ H ₅) ₂ S] ₂ Cl ₂ ; FW: 446.37; yellow powdr.	250mg 1g 5g
93-7805	cis-Dichlorobis(pyridine)platinum(II), 99% (15227-42-6) PtCl ₂ (C ₅ H ₅ N) ₂ ; FW: 424.20; yellow powdr.	1g
93-7820	cis-Dichlorobis(triethylphosphine)platinum(II), 99% (15692-07-6) PtCl ₂ [(C ₂ H ₅) ₃ P] ₂ ; FW: 502.32; white to off-white powdr.	500mg 2g
78-0410	cis-Dichlorobis(triphenylphosphine)platinum(II), 98% (15604-36-1) PtCl ₂ [(C ₆ H ₅) ₃ P] ₂ ; FW: 790.58; off-white xtl.	1g 5g
78-0430	Dichloro(1,5-cyclooctadiene)platinum(II), 99% (12080-32-9) PtCl ₂ (1,5-C ₈ H ₁₂); FW: 374.18; pale yellow xtl.; m.p. 250° dec.	250mg 1g 5g
78-0450 HAZ	cis-Dichlorodiammine platinum(II), 99% CISPLATIN (15663-27-1) cis-Pt(NH ₃) ₂ Cl ₂ ; FW: 300.06; yellow to orange xtl.; m.p. 230° dec.; b.p. dec.	250mg 1g 5g
78-0451	trans-Dichlorodiammine platinum(II), 99% (14913-33-8) trans-Pt(NH ₃) ₂ Cl ₂ ; FW: 300.06; light yellow xtl.	1g 5g
78-0460	Di-μ-chloro-dichlorobis(ethylene)diplatinum(II), min. 97% Zeise's dimer (12073-36-8) [PtCl ₂ (C ₂ H ₄) ₂] ₂ ; FW: 588.10; orange xtl. <i>air sensitive, moisture sensitive, (store cold)</i>	250mg 1g 5g
78-0475	Dichloro(dicyclopentadienyl)platinum(II), 99% (12083-92-0) C ₁₀ H ₁₂ PtCl ₂ ; FW: 398.19; off-white powdr.	250mg 1g
		
93-7806	Dihydrogen hexahydroxyplatinate(IV), 99% (51850-20-5) H ₂ Pt(OH) ₆ ; FW: 299.15; yellow powdr.	1g 5g
78-0600 HAZ	Di-μ-iodobis(ethylenediamine)diplatinum(II) nitrate, 99% PIP (109998-76-7) [Pt ₂ I ₂ (H ₂ NCH ₂ CH ₂ NH ₂) ₂](NO ₃) ₂ ; FW: 888.20; yellow xtl.	250mg 1g
93-7819	Diiodo(1,5-cyclooctadiene)platinum(II), 99% (12266-72-7) PtI ₂ (1,5-C ₈ H ₁₂); FW: 557.08; yellow powdr.	1g 5g

PLATINUM (Compounds)

78-0700	Dimethyl(1,5-cyclooctadiene)platinum(II), 99% (12266-92-1) (C ₈ H ₁₂) ₂ Pt(C ₈ H ₁₂); FW: 333.34; white powdr.	250mg 1g 5g
78-0725	Hyrido(dimethylphosphinous acid-kP)[hydrogen bis(dimethylphosphinito-kP)]platinum(II) Ghaffar-Parkins catalyst (173416-05-2) C ₆ H ₂ O ₃ P ₃ Pt; FW: 429.23; white to off-white powdr. For detailed technical note visit strem.com.	100mg 500mg 2g
78-1200	Iodotrimethylplatinum(IV), 99% (14364-93-3) (CH ₃) ₃ PtI; FW: 367.09; light orange xtl.	1g 5g
78-1400	Platinum(II) acetylacetonate, 98% (15170-57-7) Pt(CH ₃ COCHCOCH ₃) ₂ ; FW: 393.31; pale yellow xtl.	1g 5g
78-1429	Platinum(II) bromide, 98% (13455-12-4) PtBr ₂ ; FW: 354.91; brown powdr.; m.p. 250° dec.; d. 6.65	1g 5g
78-1480	Platinum(II) chloride (99.9%-Pt) (10025-65-7) HAZ PtCl ₂ ; FW: 266.00; olive-brown powdr.; m.p. 581° dec.; d. 6.05	250mg 1g 5g
78-1490	Platinum(IV) chloride (99.9%-Pt) (13454-96-1) HAZ PtCl ₄ ; FW: 336.90; reddish-brown xtl.; m.p. 370° dec.; d. 4.303 <i>moisture sensitive</i>	1g 5g
93-7825	Platinum(II) cyanide, min. 98% (592-06-3) HAZ Pt(CN) ₂ ; FW: 247.13; yellow to green xtl. Note: **Limited quantities available**	500mg 2g
78-1550	Platinum(II) hexafluoroacetylacetonate, 98% (99.9%-Pt) (65353-51-7) Pt(CF ₃ COCHCOCF ₃) ₂ ; FW: 609.22; orange xtl.; m.p. 143-145°; b.p. subl. 65°/0.1mm	500mg 2g
93-7808	Platinum(II) iodide, min. 98% (7790-39-8) PtI ₂ ; FW: 448.90; black powdr.; m.p. 360° dec.	1g 5g
78-1892	Platinum(IV) oxide hydrate (~80-82% Pt) (99.95+%-Pt) ADAMS' CATALYST [BASF C7018] (52785-06-5) HAZ PtO ₂ ·xH ₂ O; FW: 227.09; brown powdr. Note: Sold in collaboration with BASF for research purposes only. BASF Platinum Catalyst Kit component.	250mg 1g 5g
78-1890	Platinum(IV) oxide hydrate (~80-81% Pt) ADAMS' CATALYST (52785-06-5) HAZ PtO ₂ ·xH ₂ O; FW: 227.09; brown powdr.; SA: high	250mg 1g 5g
78-1925	Platinum sulfite acid solution (15.3% Pt) (61420-92-6) HAZ H ₃ Pt(SO ₃) ₂ OH; FW: 375.25; pale yellow liq.	5g 25g
78-1935	Potassium bis(oxalato)platinate(II) dihydrate, 99% (38685-12-0) See page 340	
78-1950	Potassium hexabromoplatinate(IV), 99% (16920-93-7) See page 341	
78-1960	Potassium hexachloroplatinate(IV), 99% (16921-30-5) See page 342	
78-1963	Potassium hexacyanoplatinate(IV), 99% (16920-94-8) See page 342	
78-1967	Potassium tetrabromoplatinate(II), 99% (13826-94-3) See page 344	
78-1970	Potassium tetrachloroplatinate(II) (99.9%-Pt) (10025-99-7) See page 344	
78-1980	Potassium tetracyanoplatinate(II) hydrate (562-76-5) See page 344	
78-1985	Potassium tetranitroplatinate(II), min. 98% (13815-39-9) See page 344	
78-1975	Potassium trichloroamineplatinate(II) (13820-91-2) See page 344	
78-1995	Sodium hexachloroplatinate(IV) hexahydrate, 98+% (19583-77-8) See page 418	

PLATINUM (Compounds)

93-7810	Sodium tetrachloroplatinate(II) hydrate (207683-21-4) See page 421	
78-2000	Tetraammineplatinum(II) chloride monohydrate, 99% (99.95%-Pt) (13933-32-9) [Pt(NH ₃) ₄]Cl ₂ ·H ₂ O; FW: 334.09 (352.12); white xtl.	1g 5g
78-2005	Tetraammineplatinum(II) hydroxide hydrate (59% Pt) (15651-37-3) Pt(NH ₃) ₄ (OH) ₂ ·XH ₂ O; FW: 297.23; white to off-white solid (store cold)	1g 5g
78-2010 HAZ	Tetraammineplatinum(II) nitrate, 99% (20634-12-2) [Pt(NH ₃) ₄](NO ₃) ₂ ; FW: 387.22; white to off-white powdr. <i>hygroscopic</i>	250mg 1g 5g
78-2015	Tetraammineplatinum(II) tetrachloroplatinate(II), 99% (13820-46-7) [Pt(NH ₃) ₄][PtCl ₄]; FW: 600.12; green powdr.	1g 5g
78-2025 HAZ	trans-Tetrachlorodiammine platinum(IV), 98% (16893-06-4) Pt(NH ₃) ₂ Cl ₄ ; FW: 370.96; yellow xtl.	250mg 1g
78-2024 HAZ	cis-Tetrachlorodiammine platinum(IV), 99% (16893-05-3) Pt(NH ₃) ₂ Cl ₄ ; FW: 370.96; yellow powdr.	250mg 1g 5g
78-2030	Tetrakis(triphenylphosphine)platinum(0), 98% (14221-02-4) Pt[(C ₆ H ₅) ₃ P] ₄ ; FW: 1244.21; yellow xtl. <i>air sensitive, light sensitive, (store cold)</i>	250mg 1g 5g
78-1300	(Trimethyl)cyclopentadienylplatinum(IV), 99% (1271-07-4) (CH ₃) ₃ (C ₅ H ₅)Pt; FW: 305.28; white to off-white powdr.; m.p. 104-106° <i>air sensitive</i> For detailed technical note visit strem.com .	500mg 2g
78-1350 HAZ	(Trimethyl)methylcyclopentadienylplatinum(IV), 99% (94442-22-5) (CH ₃) ₃ (CH ₃ C ₅ H ₄)Pt; FW: 319.32; off-white powdr.; m.p. 30-31°; b.p. (subl. 23°/0.053mm); d. 1.88 <i>air sensitive, (store cold)</i> Note: Available prepacked in ALD cylinder- see 98-4024, 98-4026. For detailed technical note visit strem.com .	500mg 2g 10g
98-1350 NEW	(Trimethyl)methylcyclopentadienylplatinum(IV), 99% (99.999%-Pt) PURATREM (94442-22-5) (CH ₃) ₃ (CH ₃ C ₅ H ₄)Pt; FW: 319.32; off-white powdr.; m.p. 30-31°; b.p. (subl. 23°C/0.053mm); d. 1.88 <i>air sensitive, (store cold)</i>	500mg 2g 10g
98-4024 HAZ	(Trimethyl)methylcyclopentadienylplatinum(IV), 99%, 78-1350, contained in 50 ml Swagelok® cylinder (96-1070) for CVD/ALD (94442-22-5) (CH ₃) ₃ (CH ₃ C ₅ H ₄)Pt; FW: 319.32; off-white powdr.; m.p. 30-31°; b.p. subl. 23°/0.053mm; d. 1.88 <i>air sensitive, (store cold)</i> Note: High temperature Swagelok® cylinder assembly 96-1071 available at extra cost. See 98-4026.	10g 25g
98-4026 HAZ	(Trimethyl)methylcyclopentadienylplatinum(IV), 99%, 78-1350, contained in 50 ml Swagelok® cylinder high temperature valve (96-1071) for CVD/ALD (94442-22-5) (CH ₃) ₃ (CH ₃ C ₅ H ₄)Pt; FW: 319.32; off-white powdr.; m.p. 30-31°; b.p. subl. 23°/0.053mm; d. 1.88 <i>air sensitive, (store cold)</i>	20g
78-1358	(Trimethyl)pentamethylcyclopentadienylplatinum(IV), 99% (97262-98-1) C ₁₃ H ₂₄ Pt; FW: 375.41; off-white powdr. <i>air sensitive</i>	250mg 1g 5g

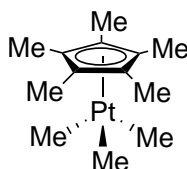
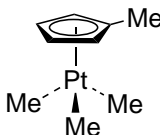
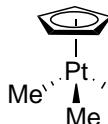

PLATINUM (Compounds)

78-1365	Tris(dibenzylideneacetone)diplatinum(0), min. 98% (63782-74-1) (C ₆ H ₅ CH=CHCOCH=CHC ₆ H ₅) ₃ Pt ₂ ; FW: 1093.03; purple-black solid <i>air sensitive</i> For detailed technical note visit strem.com .	250mg 1g
78-1360	Tris(dibenzylideneacetone)platinum(0), min. 98% (11072-92-7) (C ₆ H ₅ CH=CHCOCH=CHC ₆ H ₅) ₃ Pt; FW: 897.96; brown solid <i>air sensitive</i> For detailed technical note visit strem.com .	250mg 1g

POTASSIUM (Elemental Forms)

19-1990	Potassium (99.95%) (breakseal ampoule) (7440-09-7) amp HAZ K; FW: 39.09; under argon; m.p. 63.7°; b.p. 760°; d. 0.86 <i>air sensitive, moisture sensitive</i>	1g 5g
93-1990	Potassium (99.95%) (prescored ampoule) (7440-09-7) amp HAZ K; FW: 39.09; under argon; m.p. 63.7°; b.p. 760°; d. 0.86 <i>air sensitive, moisture sensitive</i>	1g 5g 25g
19-1910	Potassium sodium alloy 78:22 (99.95%) (11135-81-2) amp HAZ NaK; liq.; 78% K, 22% Na (under argon); m.p. -12.6°; b.p. 785°; d. 0.855 <i>air sensitive, moisture sensitive</i>	1g 5g 25g 50g

POTASSIUM (Compounds)

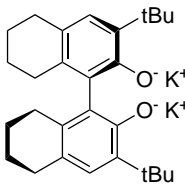
19-1600	(R)-(-)-5,5',6,6',7,7',8,8'-Octahydro-3,3'-di-t-butyl-1,1'-bi-2-naphthol, dipotassium salt (350683-75-9) C ₂₈ H ₃₆ K ₂ O ₂ ; FW: 482.80; cream-colored powdr. <i>moisture sensitive</i> For detailed technical note visit strem.com .		100mg 500mg
19-1601	(S)-(+)-5,5',6,6',7,7',8,8'-Octahydro-3,3'-di-t-butyl-1,1'-bi-2-naphthol, dipotassium salt C ₂₈ H ₃₆ K ₂ O ₂ ; FW: 482.80; cream-colored powdr. <i>moisture sensitive</i>	100mg 500mg	
Technical Note: 1. See 19-1600 (page 340)			
93-1901	Potassium acetate, 99+% (ACS) (127-08-2) KOOCC ₂ H ₃ ; FW: 98.15; white xtl.	500g 2kg	
19-1500	Potassium allyltrifluoroborate, 99% (233664-53-4) K[C ₃ H ₅ BF ₃]; FW: 147.98; white powdr. For detailed technical note visit strem.com .	250mg 1g	
19-1930	Potassium bis(fluorosulfonyl)imide, 98% (14984-76-0) K[N(SO ₂ F) ₂]; FW: 219.23; white powdr. <i>moisture sensitive</i>	1g 5g 25g	
78-1935	Potassium bis(oxalato)platinate(II) dihydrate, 99% (38685-12-0) K ₂ Pt(C ₂ O ₄) ₂ ·2H ₂ O; FW: 449.34 (485.37); yellow xtl.	1g 5g	
93-1907	Potassium borohydride, 98% (13762-51-1) HAZ KBH ₄ ; FW: 53.94; white powdr.; m.p. > 400° dec.; d. 1.178 <i>moisture sensitive</i>	50g 250g	
93-1909	Potassium bromide, 99+% (ACS) (7758-02-3) KBr; FW: 119.01; white xtl.; m.p. 730°; b.p. 1435°; d. 2.75 <i>hygroscopic</i>	100g 500g	
93-1962	Potassium bromide (99.999%-K) PURATREM (7758-02-3) KBr; FW: 119.01; white xtl.; m.p. 730°; b.p. 1435°; d. 2.75 <i>hygroscopic</i>	10g 50g	
93-1910	Potassium t-butoxide, min. 98% (865-47-4) HAZ KOC(CH ₃) ₃ ; FW: 112.21; white to off-white powdr.; m.p. 256° dec. <i>moisture sensitive</i>	50g 250g	

POTASSIUM (Compounds)

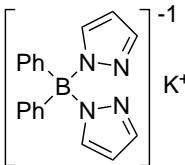
93-1912	Potassium carbonate, 99+% (ACS) (584-08-7) K ₂ CO ₃ ; FW: 138.21; white pwdr.; m.p. 891°; b.p. dec.; d. 2.428 <i>hygroscopic</i>	500g 2kg
19-2600	Potassium carbonate (99.997%-K) PURATREM (584-08-7) K ₂ CO ₃ ; FW: 138.21; white pwdr.; m.p. 891°; b.p. dec.; d. 2.428 <i>hygroscopic</i>	10g 50g
93-1913 HAZ	Potassium chlorate, 99% (ACS) (3811-04-9) KClO ₃ ; FW: 122.56; white pwdr.; m.p. 356°; b.p. 400° dec.; d. 2.32	100g 500g
93-1914	Potassium chloride, 99+% (ACS) (7447-40-7) KCl; FW: 74.56; white gran.; m.p. 776°; b.p. 1500° subl.; d. 1.984	500g 2kg
93-1977	Potassium chloride, 99+% (99.99+%K) optical grade PURATREM (7447-40-7) KCl; FW: 74.56; white xtl.; m.p. 776°; b.p. 1500° subl.; d. 1.984	10g 50g
93-1978	Potassium chloride (99.999%-K) PURATREM (7447-40-7) KCl; FW: 74.56; white xtl.; m.p. 776°; b.p. 1500° subl.; d. 1.984	25g 100g
93-1916 HAZ	Potassium cyanide, 96% (ACS) (151-50-8) KCN; FW: 65.12; white pwdr.; m.p. 634.5°; d. 1.52	250g 1kg
19-2610	Potassium di-t-butylphosphate, min. 91% (contains <5% water) (33494-80-3) K[OP(O)(OC ₄ H ₉) ₂]; FW: 248.30; white pwdr.	500mg 2g
93-1918 HAZ	Potassium dichromate, 99+% (ACS) (7778-50-9) K ₂ Cr ₂ O ₇ ; FW: 294.19; orange xtl.; m.p. 390°; b.p. 500° dec.; d. 2.676	100g 500g
79-3000 HAZ	Potassium dicyanoaurate(I), 99% (13967-50-5) KAu(CN) ₂ ; FW: 288.10; white pwdr.	250mg 1g 5g
19-3025 HAZ	Potassium dicyanocuprate (13682-73-0) KCu(CN) ₂ ; FW: 154.68; white pwdr.	10g 50g
93-1939	Potassium dihydrogen phosphate, 99+% (ACS) (7778-77-0) KH ₂ PO ₄ ; FW: 136.09; white pwdr.	250g 1kg 5kg
19-1700	Potassium diphenylbis(pyrazol-1-yl)borate, min. 98% (109088-11-1) [C ₁₈ H ₁₆ BN ₄]K; FW: 338.26; white pwdr.; m.p. 283-285°	250mg 1g
		
19-1800 HAZ	Potassium dodecahydrododecaborate hydrate, min. 98% (874881-81-9) K ₂ B ₁₂ H ₁₂ ·XH ₂ O; FW: 220.02; white pwdr. <i>hygroscopic</i>	1g 5g 25g
19-1919 HAZ	Potassium ethoxide, 95+% (917-58-8) KOC ₂ H ₅ ; FW: 84.16; white to off-white pwdr. <i>moisture sensitive</i>	100g 500g
19-1920	Potassium 2-ethylhexanoate hydrate, 95% (3164-85-0) K[OOCCH(C ₂ H ₅)C ₄ H ₉]·XH ₂ O; FW: 182.30; slightly yellow, glassy solid	5g 25g
93-1922 HAZ	Potassium fluoride, anhydrous, 98% (7789-23-3) KF; FW: 58.10; white pwdr.; m.p. 846°; b.p. 1505°; d. 2.48 <i>hygroscopic</i>	25g 100g 500g
93-1982 HAZ	Potassium fluoride, anhydrous (99.97%-K) (7789-23-3) KF; FW: 58.10; white pwdr.; m.p. 846°; b.p. 1505°; d. 2.48 <i>hygroscopic</i>	5g 25g
93-1981 HAZ	Potassium fluoride dihydrate, 98% (13455-21-5) KF·2H ₂ O; FW: 58.10 (94.13); white xtl.; m.p. 41°; b.p. 1505°; d. 2.454 <i>hygroscopic</i>	50g 250g
19-1935 amp HAZ	Potassium graphite KC₈ (12081-88-8) C ₈ K; FW: 135.18; bronze solid <i>air sensitive, moisture sensitive</i>	1g 5g 25g
78-1950	Potassium hexabromoplatinate(IV), 99% (16920-93-7) K ₂ PtBr ₆ ; FW: 752.72; red to brown pwdr.; m.p. 400° dec.; d. 4.66 <i>hygroscopic</i>	1g 5g

POTASSIUM (Compounds)

77-6500	Potassium hexachloroiridate(IV), 99% (16920-56-2) K ₂ IrCl ₆ ; FW: 483.12; black pwdr.; m.p. dec.; d. 3.546 <i>hygroscopic</i>	1g 5g
93-7611	Potassium hexachloroosmate(IV), 99% (16871-60-6) K ₂ OsCl ₆ ; FW: 481.12; red to purple xtl.; m.p. dec. <i>hygroscopic</i>	250mg 1g 5g
76-3510	Potassium hexachloroosmate (IV), 99% (99.98+%-Os) (16871-60-6) K ₂ OsCl ₆ ; FW: 481.12; red to purple xtl. <i>hygroscopic</i>	250mg 1g 5g
93-4610	Potassium hexachloropalladate(IV), 99% (16919-73-6) K ₂ PdCl ₆ ; FW: 397.32; red pwdr.; m.p. dec.; d. 2.738 <i>hygroscopic</i>	1g 5g
78-1960 HAZ	Potassium hexachloroplatinate(IV), 99% (16921-30-5) K ₂ PtCl ₆ ; FW: 486.01; yellow xtl.; m.p. 250° dec.; d. 3.499 <i>hygroscopic</i>	1g 5g
93-7502	Potassium hexachlororhenate(IV) (99.9%-Re) (16940-97-9) K ₂ ReCl ₆ ; FW: 477.12; green pwdr.; d. 3.34 <i>hygroscopic</i>	1g 5g
93-1924	Potassium hexacyanocobaltate(III) (13963-58-1) K ₃ Co(CN) ₆ ; FW: 332.32; yellow xtl.; m.p. dec.; d. 1.906	25g 100g
93-1921	Potassium hexacyanoferrate(II) trihydrate, 98.5+% (ACS) (14459-95-1) K ₄ Fe(CN) ₆ ·3H ₂ O; FW: 368.35 (422.41); yellow xtl.; m.p. 70° dec.; d. 1.85	100g 500g
93-1920	Potassium hexacyanoferrate(III), 99+% (ACS) (13746-66-2) K ₃ Fe(CN) ₆ ; FW: 329.26; red xtl.; m.p. dec.; d. 1.85	250g 1kg
78-1963 HAZ	Potassium hexacyanoplatinate(IV), 99% (16920-94-8) K ₂ Pt(CN) ₆ ; FW: 429.40; white pwdr.	250mg 1g 5g
44-1700	Potassium hexacyanoruthenate(II) hydrate (15002-31-0) K ₄ Ru(CN) ₆ ·xH ₂ O; FW: 413.59; white pwdr.	250mg 1g 5g
19-2000 HAZ	Potassium hexafluoronickelate(IV), 99% (17218-47-2) K ₂ NiF ₆ ; FW: 250.91; pink-purple pwdr. Note: A source of F ₂ ; decomposes on heating, evolving F ₂ (400√∞C) For detailed technical note visit strem.com .	10g 50g
93-1926 HAZ	Potassium hexafluorophosphate, 99.5% (17084-13-8) KPF ₆ ; FW: 184.07; white xtl.; m.p. ~-575°; b.p. dec.; d. 2.55	100g 500g
93-1959 HAZ	Potassium hexafluorosilicate, 99% (16871-90-2) K ₂ SiF ₆ ; FW: 220.28; white pwdr.; m.p. dec.	500g 2kg
45-1715	Potassium hexanitrorhodate(III), min. 97% (17712-66-2) K ₃ Rh(NO ₂) ₆ ; FW: 496.24; yellow pwdr.	1g
93-1985 HAZ	Potassium hydride, 30-35% in oil (7693-26-7) KH; FW: 40.11; slurry; gray pwdr. <i>air sensitive, moisture sensitive</i>	300g
93-1905 HAZ	Potassium hydrogen fluoride, 99+% (7789-29-9) KHF ₂ ; FW: 78.11; white pwdr.; m.p. 239°	500g 2kg
93-1940	Potassium hydrogen phosphate, 98+% (ACS) (7758-11-4) K ₂ HPO ₄ ; FW: 174.18; white pwdr.	250g 1kg
19-3300 HAZ	Potassium hydrogen sulfide, anhydrous, min. 95% (1310-61-8) KHS; FW: 72.2; white to off-white pwdr. <i>air sensitive, hygroscopic</i>	1g 5g
19-3600	Potassium hydrotris (pyrazol-1-yl)borate hydrate, 98% (18583-60-3) [C ₅ H ₁₀ BN ₂]K·XH ₂ O; FW: 252.13; white pwdr.; m.p. 185-189°	1g 5g

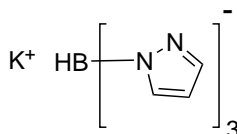

POTASSIUM (Compounds)

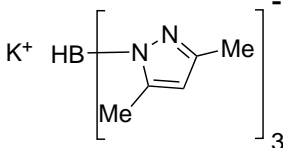
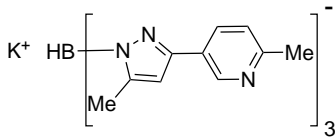
19-2900	Potassium hydrotris(3,5-dimethylpyrazol-1-yl) borate, 97% (17567-17-8) [C ₁₅ H ₂₂ BN ₃] ₃ K; FW: 336.29; white powdr.; m.p. 298-300°		1g 5g
19-3400	Potassium hydrotris (3-(6-methyl-3-pyridyl)-5-methylpyrazol-1-yl)borate, 97% (184032-07-3) [C ₃₀ H ₃₁ BN ₃] ₃ K; FW: 567.54; white powdr.; m.p. 198°		250mg 1g
19-3150 HAZ	Potassium hydroxide, pellets, 85+% (ACS) (1310-58-3) KOH; FW: 56.11; white pellets; m.p. 360°; b.p. 1324°; d. 2.044 <i>hygroscopic</i>		500g 2kg
19-3200	Potassium iodide, 99+% (ACS) (7681-11-0) KI; FW: 166.01; white powdr.; m.p. 686°; b.p. 1330°; d. 3.13 <i>hygroscopic</i>		100g 500g
93-1930	Potassium iodide (99.99%-K) PURATREM (7681-11-0) KI; FW: 166.01; white powdr.; m.p. 686°; b.p. 1330°; d. 3.13 <i>hygroscopic</i>		10g 50g
93-1941	Potassium metaphosphate, 98% (7790-53-6) KPO ₃ ; FW: 118.07; white powdr.; m.p. 807°; d. 2.393		500g 2kg
19-5380 HAZ	Potassium methylcyclopentadienide, 98% (10466-45-9) CH ₅ C ₅ H ₄ K; FW: 118.22; white to off-white solid <i>air sensitive, moisture sensitive</i>		250mg 1g 5g
19-5395 NEW HAZ	Potassium monoperoxysulfate OXONE® (70693-62-8) 2KHSO ₅ ·KHSO ₄ ·K ₂ SO ₄ ; FW: 307.37; white solid For detailed technical note visit strem.com .		25g 100g
93-4117	Potassium niobate (99.999%-Nb) PURATREM (12030-85-2) KNbO ₃ ; FW: 180.01; white powdr.		10g 50g
93-1956 HAZ	Potassium nitrate, 99+% (ACS) (7757-79-1) KNO ₃ ; FW: 101.11; white xtl.; m.p. 334°; b.p. 400° dec.; d. 2.109		500g 2kg
19-5400 HAZ	Potassium nitrate (99.999%-K) PURATREM (7757-79-1) KNO ₃ ; FW: 101.11; white xtl.; m.p. 334°; b.p. 400° dec.; d. 2.109		25g 100g
93-7613 HAZ	Potassium osmate(VI) dihydrate, 99% (10022-66-9) K ₂ OsO ₄ ·2H ₂ O; FW: 332.40 (368.43); purple powdr. <i>hygroscopic</i>		250mg 1g 5g
76-4050 HAZ	Potassium osmate(VI) dihydrate, 99% (99.98+%-Os) (10022-66-9) K ₂ OsO ₄ ·2H ₂ O; FW: 332.40 (368.43); purple powdr. <i>hygroscopic</i>		250mg 1g 5g
93-1933	Potassium pentaborate octahydrate, 97% (12229-13-9) K ₂ B ₁₀ O ₁₆ ·8H ₂ O; FW: 442.30 (586.43); white powdr.; m.p. 780°		500g 2kg
77-6590	Potassium pentachloronitrosyl iridium(III), 99% (22594-86-1) KIr(NO)Cl ₅ ; FW: 438.57; brown xtl.		1g 5g
93-1987	Potassium pentachlororuthenate(III) hydrate (14404-33-2) K ₂ RuCl ₅ ·XH ₂ O; FW: 356.53; brown powdr.		1g 5g
93-1935 HAZ	Potassium perchlorate, 99% (7778-74-7) KClO ₄ ; FW: 138.55; white powdr.; m.p. 610°; d. 2.52 <i>hygroscopic</i>		100g 500g
75-0500 HAZ	Potassium perrhenate (99%-Re) (10466-65-6) KReO ₄ ; FW: 289.30; white xtl.; m.p. 555°; b.p. ~1365°; d. 4.887		2g 10g
44-1750 HAZ	Potassium perruthenate, 98% (10378-50-4) KRuO ₄ ; FW: 204.17; black xtl.		1g 5g

POTASSIUM (Compounds)

19-3800	Potassium phosphate, anhydrous, min. 97% (7778-53-2) K ₃ PO ₄ ; FW: 212.28; coarse white solid; m.p. 1340°	250g 1kg
93-1971 HAZ	Potassium selenite (10431-47-7) K ₂ SeO ₃ ; FW: 205.16; white powdr.; m.p. 875° dec. <i>hygroscopic</i>	25g 100g
93-4739 HAZ	Potassium silver cyanide (99.9%-Ag) (506-61-6) KAg(CN) ₂ ; FW: 199.01; white powdr.	10g 50g
93-1972	Potassium sodium tartrate tetrahydrate, 99% (6381-59-5) KNaC ₄ H ₄ O ₆ ·4H ₂ O; FW: 210.29 (282.23); white xtl.	100g 500g
93-1946	Potassium sulfate, 99+% (ACS) (7778-80-5) K ₂ SO ₄ ; FW: 174.27; white powdr.	250g 1kg
19-4000	Potassium sulfate (99.999%-K) PURATREM (7778-80-5) K ₂ SO ₄ ; FW: 174.27; white xtl.	2g 10g 50g
19-3900 HAZ	Potassium sulfide, anhydrous, min. 95% (1312-73-8) K ₂ S; FW: 110.26; white to yellow powdr. <i>air sensitive, hygroscopic</i>	1g 5g
93-1970 HAZ	Potassium superoxide, min. 96% (12030-88-5) KO ₂ ; FW: 71.10; yellow powdr.; m.p. ~400°; d. 2.14 <i>moisture sensitive</i>	25g 100g 450g
93-1949	Potassium tellurite(IV) hydrate, 97% (123333-66-4) K ₂ TeO ₃ ·XH ₂ O; FW: 253.80; white powdr.; m.p. 465° dec.	5g 25g 100g
93-1950	Potassium tetraborate tetrahydrate, 99+% (12045-78-2) K ₂ B ₄ O ₇ ·4H ₂ O; FW: 233.44 (305.51); white powdr.; m.p. dec.; d. 1.74	500g 2kg
79-3250	Potassium tetrabromoaurate(III) dihydrate, 99% (14323-32-1) KAuBr ₄ ·2H ₂ O; FW: 555.71 (591.74); reddish-brown xtl.	1g 5g
93-4611	Potassium tetrabromopalladate(II), 98% (13826-93-2) K ₂ PdBr ₄ ; FW: 504.21; reddish-brown powdr. <i>hygroscopic</i>	1g 5g
78-1967	Potassium tetrabromoplatinate(II), 99% (13826-94-3) K ₂ PtBr ₄ ; FW: 592.93; red powdr.	1g 5g
93-7906	Potassium tetrachloroaurate(III) hydrate (99.99%-Au) (51%-Au) PURATREM (13682-61-6) KAuCl ₄ ·XH ₂ O; FW: 377.88; yellow to orange xtl.	1g 5g
46-2126	Potassium tetrachloropalladate(II), 99% (10025-98-6) K ₂ PdCl ₄ ; FW: 326.41; brown powdr.; m.p. dec.; d. 2.67 <i>hygroscopic</i>	1g 5g
78-1970 HAZ	Potassium tetrachloroplatinate(II) (99.9%-Pt) (10025-99-7) K ₂ PtCl ₄ ; FW: 415.11; pink to red powdr.; d. 3.38 <i>hygroscopic</i>	1g 5g 25g
93-2836 HAZ	Potassium tetracyanonickelate(II) hydrate (339527-86-5) K ₂ [Ni(CN) ₄]·H ₂ O; FW: 240.99 (259.01); yellow xtl.	10g 50g
78-1980 HAZ	Potassium tetracyanoplatinate(II) hydrate (562-76-5) K ₂ Pt(CN) ₄ ·XH ₂ O; FW: 377.36; white to off-white powdr. <i>hygroscopic</i>	250mg 1g 5g
93-1951 HAZ	Potassium tetrafluoroborate (14075-53-7) KBF ₄ ; FW: 125.91; white powdr.; m.p. 529.5°; d. 2.50 <i>hygroscopic</i>	500g 2kg
78-1985	Potassium tetranitroplatinate(II), min. 98% (13815-39-9) K ₂ Pt(NO ₂) ₄ ; FW: 457.32; white powdr.	1g 5g
93-1952	Potassium thiocyanate, 99+% (ACS) (333-20-0) KSCN; FW: 97.18; white xtl.	50g 250g
78-1975	Potassium trichloroamineplatinate(II) (13820-91-2) K[PtCl ₃ NH ₂]; FW: 357.56; yellow to orange xtl.	100mg 500mg
78-1990	Potassium trichloro(ethylene)platinate(II) monohydrate (12012-50-9) K[PtCl ₃ (C ₂ H ₄)]·H ₂ O; FW: 368.60 (386.62); yellow xtl. <i>hygroscopic</i>	500mg 2g

POTASSIUM (Compounds)

06-1700 HAZ	Potassium tricyanomethanide, min. 98% (34171-69-2) KC(CN) ₃ ; FW: 129.16; off-white to beige powdr.	1g 5g
19-1970 HAZ	Potassium triethylborohydride, 1.0M in THF, in Sure/Seal™ bottle (22560-21-0) KB(CH ₂ CH ₃) ₃ H; FW: 138.10; liq. <i>air sensitive, moisture sensitive</i>	0.1mole 0.5mole
19-1977	Potassium trifluoromethanesulfonimide, min. 97% (90076-67-8) K[N(SO ₂ CF ₃) ₂]; FW: 319.25; white powdr. <i>hygroscopic</i>	250mg 1g 5g
93-1955	Potassium triphosphate, 94+% (13845-36-8) K ₃ P ₃ O ₁₀ ; FW: 448.42; white powdr.; m.p. 620°; d. 2.54	250g 1kg
19-1965 HAZ 	Potassium tri-sec-butylborohydride, 1.0M in THF, in Sure/Seal™ bottle (54575-49-4) KB[CH(CH ₃)C ₂ H ₅] ₃ H; FW: 222.27; colorless liq.; f.p. 1°F (THF) <i>moisture sensitive</i>	0.1mole 0.5mole
19-5000	Potassium tris(oxalato)ferrate(III) trihydrate (5936-11-8) K ₃ Fe(C ₂ O ₄) ₃ ·3H ₂ O; FW: 437.20 (491.25); green xtl. <i>light sensitive</i>	10g 50g
93-1957	Potassium tungstate (99.5%-W) (7790-60-5) K ₂ WO ₄ ; FW: 326.04; white powdr.	10g 50g
19-6000	2,2,6,6-Tetramethyl-3,5-heptanedionato potassium, min. 95% [K(TMHD)] (22441-14-1) KC ₁₁ H ₁₉ O ₂ ; FW: 222.40; light brown powdr.; b.p. dec. 150° <i>hygroscopic</i>	1g 5g 25g

PRASEODYMIUM (Elemental Forms)

93-5941 HAZ	Praseodymium chips (99.9% REO) (7440-10-0) Pr; FW: 140.90; (packed in mineral oil); m.p. 935°; b.p. 3127°; d. 6.782 <i>air sensitive, moisture sensitive</i>	5g 25g
93-5942 HAZ	Praseodymium ingot (99.9% REO) (7440-10-0) Pr; FW: 140.90; (packed in mineral oil); m.p. 935°; b.p. 3127°; d. 6.782 <i>air sensitive, moisture sensitive</i> For detailed technical note visit strem.com .	10g 50g
93-5940 HAZ	Praseodymium powder (99.9% REO) (7440-10-0) Pr; FW: 140.90; -40 mesh (under argon); m.p. 935°; b.p. 3127°; d. 6.782 <i>air sensitive, moisture sensitive</i>	5g 25g

PRASEODYMIUM (Compounds)

93-5901	Praseodymium(III) acetate hydrate (99.9%-Pr) (REO) (6192-12-7) Pr(OOCCH ₃) ₃ ·XH ₂ O; FW: 318.04; green xtl. <i>hygroscopic</i>	10g 50g 250g
59-2002	Praseodymium(III) acetylacetonate hydrate (99.9%-Pr) (REO) (14553-09-4) Pr(CH ₃ COCHCOCH ₃) ₃ ·XH ₂ O; FW: 438.23; pale green powdr.	5g 25g 100g
93-5905	Praseodymium(III) chloride, anhydrous (99.9%-Pr) (REO) (10361-79-2) PrCl ₃ ; FW: 247.24; green to blue powdr.; m.p. 786°; b.p. 1700°; d. 4.02 <i>hygroscopic</i>	5g 25g
93-5926	Praseodymium(III) chloride heptahydrate (99.9%-Pr) (REO) (10025-90-8) PrCl ₃ ·7H ₂ O; FW: 247.27 (373.38); green xtl.; m.p. 115°; d. 2.250 <i>hygroscopic</i>	25g 100g
93-5906	Praseodymium(III) fluoride (99.9%-Pr) (REO) (13709-46-1) PrF ₃ ; FW: 197.90; light green to blue powdr. <i>hygroscopic</i>	10g 50g
93-5907	Praseodymium(III) hexafluoroacetylacetonate (99.9%-Pr) (REO) (47814-20-0) Pr(CF ₃ COCHCOCF ₃) ₃ ; FW: 762.06; light green powdr.	1g 5g
93-5909 HAZ	Praseodymium(III) nitrate hexahydrate (99.9%-Pr) (REO) (15878-77-0) Pr(NO ₃) ₃ ·6H ₂ O; FW: 326.92 (435.02); light green xtl.	50g 250g
93-5911	Praseodymium(III,IV) oxide (99.9%-Pr) (REO) (12037-29-5) Pr ₆ O ₁₁ ; FW: 1021.43; black powdr.	10g 50g 250g

PRASEODYMIUM (Compounds)

93-5910	Praseodymium(III,IV) oxide (99.99%-Pr) (REO) PURATREM (12037-29-5) Pr ₆ O ₁₁ ; FW: 1021.43; black pwdr.	1g 5g 25g
93-5912 HAZ	Praseodymium(III) perchlorate, 50% aqueous solution (99.9%-Pr) (REO) (51411-03-1) Pr(ClO ₄) ₃ ; FW: 439.26; colorless liq.	10g 50g
93-5913	Praseodymium(III) phosphate (14298-31-8) PrPO ₄ ; FW: 235.88; green pwdr.	5g 25g
59-5000 amp HAZ	Praseodymium(III) i-propoxide (99.9%-Pr) (REO) (19236-14-7) Pr(OC ₂ H ₅) ₃ ; FW: 318.12; green pwdr.; b.p. subl. 175°/0.04mm <i>moisture sensitive</i>	1g 5g
93-5914	Praseodymium(III) sulfate hydrate (99.9%-Pr) (REO) (10277-44-8) Pr ₂ (SO ₄) ₃ ·xH ₂ O; FW: 570.00; light green xtl.	10g 50g
59-7000	Praseodymium(III) trifluoromethanesulfonate, min. 98% (Praseodymium triflate) (52093-27-3) Pr(CF ₃ SO ₃) ₃ ; FW: 588.12; green pwdr. <i>heat sensitive, hygroscopic</i>	5g 25g
59-7500 amp	Tris(cyclopentadienyl)praseodymium (99.9%-Pr) (REO) (11077-59-1) (C ₅ H ₅) ₃ Pr; FW: 336.20; yellow pwdr.; m.p. 427° dec.; b.p. subl. 220°/0.01mm <i>air sensitive, moisture sensitive</i>	1g 5g
93-5920	Tris(6,6,7,7,8,8,8-heptafluoro-2,2-dimethyl-3, 5-octanedionate) praseodymium(III), 99% (99.9%-Pr) (REO) [Pr(FOD) ₃] (17978-77-7) Pr(C ₁₀ H ₁₀ F ₇ O ₂) ₃ ; FW: 1026.45; light green pwdr.; m.p. 215-219°; b.p. subl. 130°/0.01mm	1g 5g
59-8000 amp	Tris(i-propylcyclopentadienyl)praseodymium (99.9%-Pr) (REO) (69021-86-9) (C ₃ H ₇ C ₅ H ₄) ₃ Pr; FW: 462.44; light green xtl. <i>air sensitive, moisture sensitive</i>	1g 5g
93-5937	Tris(2,2,6,6-tetramethyl-3,5-heptanedionato) praseodymium(III), 99% (99.9%-Pr) (REO) [Pr(TMHD) ₃] (15492-48-5) Pr(C ₁₁ H ₁₉ O ₂) ₃ ; FW: 690.72; light green pwdr.; m.p. 212-214°; b.p. dec. 300° (subl. 150°/0.1mm)	1g 5g

RHENIUM (Elemental Forms)

75-0050	Rhenium foil (99.9+%) (7440-15-5) Re; FW: 186.20; 0.025mm thick (~0.33g/25x 25mm); m.p. 3180°; b.p. 5900°; d. 21.04	25 x 25mm 50 x 50mm
75-0060	Rhenium foil (99.99%) (7440-15-5) Re; FW: 186.21; 0.1mm thick (~1.32g/25 x25mm)	25 x 25mm 50 x 50mm
75-0075	Rhenium pellets (99.99%) (7440-15-5) Re; FW: 186.20; 9mm dia. x 4mm thick (~3g/pellet); m.p. 3180°; b.p. 5900°; d. 21.04	2g 10g 50g
75-1890 HAZ	Rhenium powder (99.99%), PURATREM (7440-15-5) Re; FW: 186.20; -325 mesh pwdr.; SA: high; m.p. 3180°; b.p. 5900°; d. 21.04	1g 5g
75-0090	Rhenium wire (99.97%) (7440-15-5) Re; FW: 186.20; 0.25 mm dia. (~1.03g/m); m.p. 3180°; b.p. 5900°; d. 21.04	10cm 50cm

RHENIUM (Compounds)

93-0249	Ammonium perrhenate, 99+% (13598-65-7) See page 6	
02-0900	Ammonium perrhenate (99.999%-Re) PURATREM (13598-65-7) See page 6	
75-2360 NEW	Chlorotricarbonyl(2,2'-bipyridine)rhenium(I), 99% (55658-96-3) C ₁₃ H ₈ ClN ₂ O ₃ Re; yellow solid For detailed technical note visit strem.com .	250mg 1g

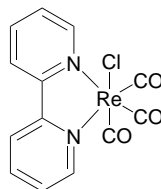

RHENIUM (Compounds)

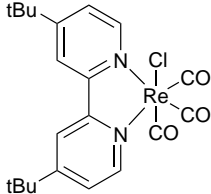
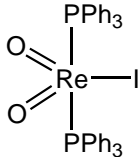
75-2365 NEW	Chlorotricarbonyl(4,4'-di-t-butyl-2,2'-bipyridine) rhenium(I), 99% (165612-19-1) $C_{24}H_{24}ClN_2O_2Re$; FW: 574.09; yellow solid For detailed technical note visit strem.com .		250mg 1g
75-2300	Cyclopentadienylrhenium tricarbonyl, 99% (12079-73-1) $(C_5H_5)Re(CO)_3$; FW: 335.33; white xtl.		250mg 1g 5g
75-2345	Iododioxobis(triphenylphosphine)rhenium(V), 98% (23032-93-1) $ReI_2O_2[P(C_6H_5)_3]_2$; FW: 869.68; violet xtl. For detailed technical note visit strem.com .		1g 5g
75-2375	Methyltrioxorhenium(VII), 98% (70197-13-6) CH_3ReO_3 ; FW: 249.23; colorless to pale-gray xtl.; m.p. 111°; b.p. subl. 65°/0.001mm For detailed technical note visit strem.com .		250mg 1g 5g
75-2400	Pentamethylcyclopentadienylrhenium tricarbonyl, min. 98% (12130-88-0) $[(CH_3)_5C_5]Re(CO)_3$; FW: 405.46; off-white powdr.; m.p. 149-151°		100mg 500mg 2g
93-7501 HAZ	Perrhenic acid, aqueous solution (50-54% Re) (99.99%-Re) PURATREM (13768-11-1) $HReO_4$; FW: 251.26; colorless liq.		2g 10g 50g
93-7502	Potassium hexachlororhenate(IV) (99.9%-Re) (16940-97-9) See page 342		
75-0500	Potassium perrhenate (99%-Re) (10466-65-6) See page 343		
75-2410 amp	i-Propylcyclopentadienylrhenium tricarbonyl, min. 97% (126250-68-8) $(C_3H_7)C_5H_4Re(CO)_3$; FW: 377.41; light-yellow liq. (store cold)		250mg 1g
75-1800	Rhenium carbonyl, 98% (14285-68-8) $Re_2(CO)_{10}$; FW: 652.51; white to yellow xtl.; m.p. 170° dec.; d. 2.87		1g 5g 25g
93-7506	Rhenium(V) chloride (99.9%-Re) (13596-35-5) $ReCl_5$; FW: 363.47; greenish-black xtl.; m.p. dec.; d. 4.9 moisture sensitive		1g 5g
75-2497	Rhenium(IV) oxide dihydrate (99.9%-Re) (12036-09-8) $ReO_2 \cdot 2H_2O$; FW: 218.24 (254.27); black powdr.; m.p. 1000° dec.; d. 11.4		1g 5g
75-2500	Rhenium(VI) oxide (99.9%-Re) (1314-28-9) ReO_3 ; FW: 234.31; purple xtl.; SA: high; m.p. 400° dec.		250mg 1g 5g
93-7505 HAZ	Rhenium(VII) oxide (99.99%-Re) PURATREM (1314-68-7) Re_2O_7 ; FW: 484.40; yellow to pale green powdr.; m.p. ~297°; b.p. 250° subl.; d. 6.103 hygroscopic		1g 5g
75-0150	Rhenium pentacarbonyl bromide, 98% (14220-21-4) $Re(CO)_5Br$; FW: 406.16; off-white xtl.; m.p. 90° subl.		250mg 1g 5g
75-4000	Rhenium pentacarbonyl chloride, 98% (14099-01-5) $Re(CO)_5Cl$; FW: 361.71; off-white xtl.		1g 5g
93-7508	Sodium perrhenate (99.9%-Re) (13472-33-8) See page 420		
75-1000	Tetrabutylammonium tetrathiorhenate(VII), 99% (16829-47-3) See page 7		

RHENIUM (Compounds)

75-2385 **Trifluoromethylsulfonatotricarbonyl(2,2'-bipyridine) rhenium(I), 99%** (7440-94-0)
NEW $C_{14}H_8F_3N_2O_3ReS$; FW: 575.49; light yellow powdr.

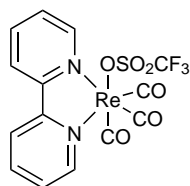

100mg
500mg

RHODIUM (Elemental Forms)

45-1500 **Rhodium black (99.9%)** (7440-16-6) 500mg
 HAZ Rh; FW: 102.91; black powdr.; m.p. 1966°; b.p. 3727°; d. 12.41 2g

45-1550 **Rhodium colloid (polyethyleneglycol-dodecylether hydrosol) (~9 wt% Rh)** (7440-16-6)
 See page 164

Rhodium nanoparticles - surfactant and reactant-free (pure) manufactured via laser ablation (7440-16-6)
 See page 165

45-1863 **Rhodium, 5% on activated carbon (50-70% wetted powder) Evonik Noblyst® P3053** (7440-16-6) 10g
 wetted, black powdr. 50g
 Note: Sold in collaboration with Evonik for research purposes only. Evonik Heterogeneous Catalyst Kit component. Evonik Heterogeneous Catalyst Kit for Selective Hydrogenation component.

45-1875 **Rhodium, 5% on activated wood carbon, reduced, 50% water wet paste (Escat™ 3401)** (7440-16-6) 1g
 black powdr. (d50=18 μm); SA: 900m²/g 5g
 Note: Sold in collaboration with BASF for research purposes only. BASF Heterogeneous Catalyst Kit component.

Technical Note:

1. Escat™ 3401 catalyst is recommended for a broad range of reactions common to rhodium on carbon catalysts. Specifically, it is well suited for hydrogenation of aromatic rings at mild pressure and temperature.

45-1810 **Rhodium, 0.5% on alumina** (7440-16-6) 5g
 Rh on Al₂O₃; 1/8" x 1/8" pellets; SA: ~100 m²/g; P.Vol. 0.40 cc/g 25g

45-1830 **Rhodium, 5% on alumina** (7440-16-6) 1g
 Rh on Al₂O₃; powdr.; SA: 80-100 m²/g 5g
 25g

45-1860 **Rhodium, 5% on carbon** (7440-16-6) 1g
 HAZ Rh on carbon; powdr.; SA: ~1050 m²/g 5g
 25g

45-1870 **Rhodium powder (99.8%)** (7440-16-6) 500mg
 HAZ Rh; FW: 102.91; m.p. 1966°; b.p. 3727°; d. 12.41 2g

45-1872 **Rhodium powder (99.95%)** (7440-16-6) 500mg
 HAZ Rh; FW: 102.91; m.p. 1966°; b.p. 3727°; d. 12.41 2g

45-1660 **Rhodium/tetra-n-octylammonium chloride colloid, purified (70-75% Rh)** (7440-16-6)
 See page 164

RHODIUM (Compounds)

45-0016 **Acetylacetonatobis(cyclooctene)rhodium(I), min. 97%** (34767-55-0) 100mg
 Rh(C₈H₁₄)₂(C₅H₇O₂); FW: 422.41; yellow powdr. 500mg
air sensitive, (store cold) 2g

45-0020 **Acetylacetonatobis(ethylene)rhodium(I), 99%** (12082-47-2) 100mg
 Rh(C₂H₄)₂(C₅H₇O₂); FW: 258.13; yellow to orange xtl. 500mg
air sensitive, (store cold) 2g

RHODIUM (Compounds)

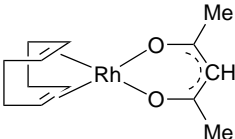
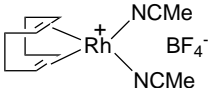
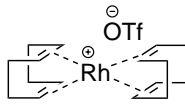
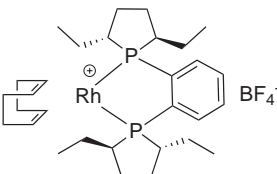
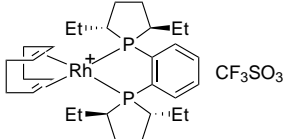
45-0010	Acetylacetonato(1,5-cyclooctadiene)rhodium(I), 98% (12245-39-5) Rh(C ₈ H ₁₂)(C ₅ H ₇ O ₂); FW: 310.19; orange xtl. <i>air sensitive, (store cold)</i>		100mg 500mg
45-0035	Ammonium hexachlororhodate(III) hydrate (15336-18-2) See page 5		
02-0590	Ammonium hexachlororhodate(III) monohydrate (99.995%-Rh) PURATREM (15336-18-2) See page 5		
45-0115	Bis(acetonitrile)(1,5-cyclooctadiene)rhodium(I) tetrafluoroborate, min. 97% (46360-78-5) [Rh(C ₈ H ₁₂)(CH ₃ CN) ₂] ⁺ BF ₄ ⁻ ; FW: 380.00; yellow powder.		250mg 1g
45-0109	Bis(1,5-cyclooctadiene)rhodium(I) tetrafluoroborate, 98+% (35138-22-8) Rh(C ₈ H ₁₂) ₂ ⁺ BF ₄ ⁻ ; FW: 406.07; red-brown solid <i>air sensitive</i> For detailed technical note visit strem.com .		100mg 500mg 2g
45-0110	Bis(1,5-cyclooctadiene)rhodium(I) trifluoromethane-sulfonate, 99% (99326-34-8) Rh(1,5-C ₈ H ₁₂) ₂ ⁺ SO ₃ CF ₃ ⁻ ; FW: 468.34; dark red xtl.; m.p. 159° (dec.) <i>air sensitive, (store cold)</i> For detailed technical note visit strem.com .		100mg 500mg 2g
45-0148	(-)-1,2-Bis((2R,5R)-2,5-diethylphospholano)benzene(1,5-cyclooctadiene)rhodium(I) tetrafluoroborate, 98+% (R,R)-Et-DUPHOS-Rh (228121-39-9) Rh(C ₈ H ₁₂)(C ₂₂ H ₃₆ P ₂) ⁺ BF ₄ ⁻ ; FW: 660.37; red-orange xtl. <i>air sensitive</i> Note: (R,R)-Duphos and BPE Rhodium Catalysts Kit component. For detailed technical note visit strem.com .		100mg 500mg 2g
45-0149	(+)-1,2-Bis((2S,5S)-2,5-diethylphospholano)benzene(1,5-cyclooctadiene)rhodium(I) tetrafluoroborate, 98+% (S,S)-Et-DUPHOS-Rh (213343-64-7) Rh(C ₈ H ₁₂)(C ₂₂ H ₃₆ P ₂) ⁺ BF ₄ ⁻ ; FW: 660.37; red-orange xtl. <i>air sensitive</i> Note: (S,S)-Duphos and BPE Rhodium Catalysts Kit component.		100mg 500mg 2g
Technical Note: 1. See 45-0148 (page 349)			
45-0150	(-)-1,2-Bis((2R,5R)-2,5-diethylphospholano)benzene(1,5-cyclooctadiene)rhodium(I) trifluoromethanesulfonate, 98+% (R,R)-Et-DUPHOS-Rh (136705-77-6) Rh(C ₈ H ₁₂)(C ₂₂ H ₃₆ P ₂) ⁺ CF ₃ SO ₃ ⁻ ; FW: 722.63; orange xtl. <i>air sensitive, (store cold)</i> Note: (R,R)-Duphos and BPE Rhodium Catalysts Kit component. For detailed technical note visit strem.com .		100mg 500mg 2g
45-0151	(+)-1,2-Bis((2S,5S)-2,5-diethylphospholano)benzene(1,5-cyclooctadiene)rhodium(I) trifluoromethanesulfonate, 98+% (S,S)-Et-DUPHOS-Rh (142184-30-3) Rh(C ₈ H ₁₂)(C ₂₂ H ₃₆ P ₂) ⁺ CF ₃ SO ₃ ⁻ ; FW: 722.63; orange xtl. <i>air sensitive, (store cold)</i> Note: (S,S)-Duphos and BPE Rhodium Catalysts Kit component. For detailed technical note visit strem.com .		100mg 500mg 2g

RHODIUM (Compounds)

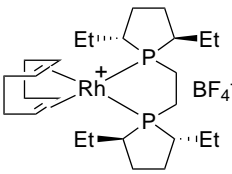
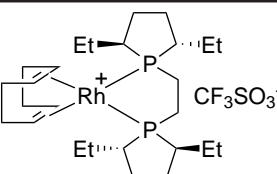
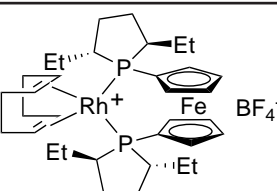
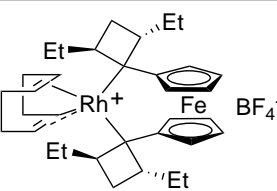
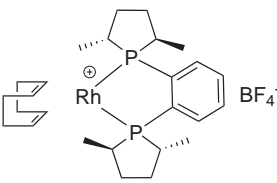
45-3010	1,2-Bis((2R,5R)-2,5-diethylphospholano)ethane(cyclooctadiene)rhodium(I) tetrafluoroborate (136705-70-9) $C_{26}H_{48}BF_4P_2Rh$; FW: 612.32; orange-red solid <i>air sensitive</i> Note: Sold under license from Kanata for research purposes only.		100mg 500mg
45-3011	1,2-Bis((2S,5S)-2,5-diethylphospholano)ethane(cyclooctadiene)rhodium(I) tetrafluoroborate $C_{26}H_{48}BF_4P_2Rh$; FW: 612.32; orange-red solid <i>air sensitive</i> Note: Sold under license from Kanata for research purposes only.		100mg 500mg
Technical Note: 1. See 45-3010 (page 350)			
45-3016	1,2-Bis((2S,5S)-2,5-diethylphospholano)ethane(cyclooctadiene)rhodium(I) trifluoromethanesulfonate $C_{27}H_{48}F_3O_3P_2RhS$; FW: 674.58; orange-red solid <i>air sensitive</i> Note: Sold under license from Kanata for research purposes only.		100mg 500mg
45-3018	1,1'-Bis((2R,5R)-2,5-diethylphospholano)ferrocene(cyclooctadiene)rhodium(I) tetrafluoroborate (162412-90-0) $C_{34}H_{52}BF_4FeP_2Rh$; FW: 768.28; orange-red solid <i>air sensitive</i> Note: Sold under license from Kanata for research purposes only.		100mg 500mg
45-3019	1,1'-Bis((2S,5S)-2,5-diethylphospholano)ferrocene(cyclooctadiene)rhodium(I) tetrafluoroborate (290347-88-5) $C_{34}H_{52}BF_4FeP_2Rh$; FW: 768.28; orange-red solid <i>air sensitive</i> Note: Sold under license from Kanata for research purposes only.		100mg 500mg
45-0155	(-)-1,1'-Bis((2S,4S)-2,4-diethylphosphotano)ferrocene(1,5-cyclooctadiene)rhodium(I) tetrafluoroborate, min. 98% $[[C_9H_4(C_8H_{14}P)]_2Fe](C_8H_{12})Rh^+BF_4^-$; FW: 740.24; orange powdr.; m.p. 207° <i>air sensitive</i> Note: **Limited quantities available** Sold in collaboration with Chirotech for research purposes only. US Patent no. 5936109. For detailed technical note visit strem.com .		100mg
45-0158	(-)-1,2-Bis((2R,5R)-2,5-dimethylphospholano)benzene(1,5-cyclooctadiene)rhodium(I) tetrafluoroborate, 98+% (R,R)-Me-DUPHOS-Rh (210057-23-1) $Rh(C_8H_{12})(C_{18}H_{28}P_2)^+BF_4^-$; FW: 604.26; red-orange xtl. <i>air sensitive</i> Note: (R,R)-Duphos and BPE Rhodium Catalysts Kit component. For detailed technical note visit strem.com .		100mg 500mg 2g
45-0159	(+)-1,2-Bis((2S,5S)-2,5-dimethylphospholano)benzene(1,5-cyclooctadiene)rhodium(I) tetrafluoroborate, 98+% (S,S)-Me-DUPHOS-Rh (205064-10-4) $Rh(C_8H_{12})(C_{18}H_{28}P_2)^+BF_4^-$; FW: 604.26; red-orange xtl. <i>air sensitive</i> Note: (S,S)-Duphos and BPE Rhodium Catalysts Kit component. For detailed technical note visit strem.com .		100mg 500mg 2g

RHODIUM (Compounds)

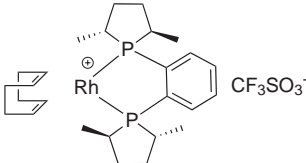
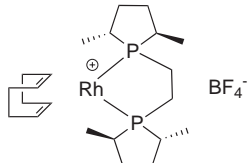
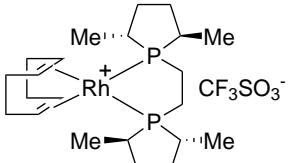
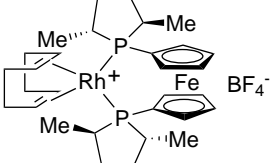
45-0160	<p>(-)-1,2-Bis((2R,5R)-2,5-dimethylphospholano)benzene(1,5-cyclooctadiene)rhodium(I) trifluoromethanesulfonate, 98+% (R,R)-Me-DUPHOS-Rh (187682-63-9) $\text{Rh}(\text{C}_8\text{H}_{12})(\text{C}_{18}\text{H}_{28}\text{P}_2)^+\text{CF}_3\text{SO}_3^-$; FW: 666.53; orange xtl. <i>air sensitive, (store cold)</i> Note: (R,R)-Duphos and BPE Rhodium Catalysts Kit component. For detailed technical note visit strem.com.</p>		100mg 500mg 2g
45-0161	<p>(+)-1,2-Bis((2S,5S)-2,5-dimethylphospholano)benzene(1,5-cyclooctadiene)rhodium(I)trifluoromethanesulfonate, 98+% (S,S)-Me-DUPHOS-Rh (136705-75-4) $\text{Rh}(\text{C}_8\text{H}_{12})(\text{C}_{18}\text{H}_{28}\text{P}_2)^+\text{CF}_3\text{SO}_3^-$; FW: 666.53; orange xtl. <i>air sensitive, (store cold)</i> Note: (S,S)-Duphos and BPE Rhodium Catalysts Kit component. For detailed technical note visit strem.com.</p>		100mg 500mg 2g
45-0168	<p>(+)-1,2-Bis((2R,5R)-2,5-dimethylphospholano)ethane(1,5-cyclooctadiene)rhodium(I) tetrafluoroborate, 98+% (R,R)-Me-BPE-Rh (305818-67-1) $\text{Rh}(\text{C}_8\text{H}_{12})(\text{C}_{14}\text{H}_{28}\text{P}_2)^+\text{BF}_4^-$; FW: 556.21; red-orange xtl. <i>air sensitive</i> Note: (R,R)-Duphos and BPE Rhodium Catalysts Kit component. For detailed technical note visit strem.com.</p>		100mg 500mg 2g
45-0169	<p>(-)-1,2-Bis((2S,5S)-2,5-dimethylphospholano)ethane(1,5-cyclooctadiene)rhodium(I) tetrafluoroborate, 98+% (S,S)-Me-BPE-Rh (213343-65-8) $\text{Rh}(\text{C}_8\text{H}_{12})(\text{C}_{14}\text{H}_{28}\text{P}_2)^+\text{BF}_4^-$; FW: 556.21; red-orange xtl. <i>air sensitive</i> Note: (S,S)-Duphos and BPE Rhodium Catalyst Kit component. For detailed technical note visit strem.com.</p>		100mg 500mg 2g
45-3032	<p>1,2-Bis((2R,5R)-2,5-dimethylphospholano)ethane(cyclooctadiene)rhodium(I) trifluoromethanesulfonate (854275-87-9) $\text{C}_{23}\text{H}_{40}\text{F}_3\text{O}_3\text{P}_2\text{RhS}$; FW: 618.48; orange-red solid <i>air sensitive</i> Note: Sold under license from Kanata for research purposes only.</p>		100mg 500mg
45-3033	<p>1,2-Bis((2S,5S)-2,5-dimethylphospholano)ethane(cyclooctadiene)rhodium(I) trifluoromethanesulfonate (854920-90-4) $\text{C}_{23}\text{H}_{40}\text{F}_3\text{O}_3\text{P}_2\text{RhS}$; FW: 618.48; orange-red solid <i>air sensitive</i> Note: Sold under license from Kanata for research purposes only.</p>		100mg 500mg
45-3036	<p>1,1'-Bis((2R,5R)-2,5-dimethylphospholano)ferrocene(cyclooctadiene)rhodium(I) tetrafluoroborate (854275-87-9) $\text{C}_{30}\text{H}_{44}\text{BF}_4\text{FeP}_2\text{RhS}$; FW: 712.17; orange-red solid <i>air sensitive</i> Note: Sold under license from Kanata for research purposes only.</p>		100mg 500mg

RHODIUM (Compounds)

45-3037	1,1'-Bis((2S,5S)-2,5-dimethylphospholano)ferrocene(cyclooctadiene)rhodium(I) tetrafluoroborate (854920-90-4) $C_{30}H_{44}BF_4FeP_2Rh$; FW: 712.17; orange-red solid <i>air sensitive</i> Note: Sold under license from Kanata for research purposes only.	100mg 500mg	
45-0766	(-)-2,3-Bis[(2R,5R)-2,5-dimethylphospholanyl]-1-[3,5-bis(trifluoromethyl)phenyl]-1H-pyrrole-2,5-dione(1,5-cyclooctadiene)rhodium(I) tetrafluoroborate, min. 97% [catASium® MNXylF(R)Rh] $Rh(C_8H_{12})(C_{24}H_{27}F_8NO_2P_2) \cdot BF_4^-$; FW: 835.31; red to dark red solid <i>air sensitive</i> Note: Sold in collaboration with Solvias for research purposes only. Patent WO 03084971. For detailed technical note visit strem.com .	100mg	
45-0750	(-)-4,5-Bis[(2R,5R)-2,5-dimethylphospholanyl](1,2-dimethyl-1,2-dihydropyridazine-3,6-dione)(1,5-cyclooctadiene)rhodium(I) tetrafluoroborate, min. 95% [catASium® MNN(R)Rh] (908128-78-9) $Rh(C_8H_{12})(C_{18}H_{30}N_2O_2P_2) \cdot BF_4^-$; FW: 666.28; orange-brown powdr. <i>air sensitive</i> Note: Sold in collaboration with Solvias for research purposes only. Patent WO 03084971. For detailed technical note visit strem.com .	100mg	
45-0754	(-)-2,3-Bis[(2R,5R)-2,5-dimethylphospholanyl]maleic anhydride(1,5-cyclooctadiene)rhodium(I) hexafluoroantimonate, min. 97% [catASium® M(R)RhSbF6] $Rh(C_8H_{12})(C_{16}H_{24}O_3P_2) \cdot SbF_6^-$; FW: 773.15; orange-brown powdr. <i>air sensitive</i> Note: Sold in collaboration with Evonik for research purposes only. Patent WO 03084971. For detailed technical note visit strem.com .	100mg 500mg	
45-0758	(-)-2,3-Bis[(2R,5R)-2,5-dimethylphospholanyl]maleic anhydride(1,5-cyclooctadiene)rhodium(I) trifluoromethanesulfonate, min. 97% [catASium® M(R)RhOTf] $Rh(C_8H_{12})(C_{16}H_{24}O_3P_2) \cdot CF_3SO_3^-$; FW: 686.46; orange powdr. <i>air sensitive</i> Note: Sold in collaboration with EVONIK for research purposes only. Patent WO 03084971. For detailed technical note visit strem.com .	100mg	
45-0176	(-)-2,3-Bis[(2R,5R)-2,5-dimethylphospholanyl]-1-methyl-1H-pyrrole-2,5-dione(1,5-cyclooctadiene)rhodium(I) tetrafluoroborate, min. 97% [catASium® MN(R)Rh] $Rh(C_8H_{12})(C_{17}H_{27}NO_2P_2) \cdot BF_4^-$; FW: 637.24; red-orange powdr. <i>air sensitive</i> Note: Optical purity: 95% Sold in collaboration with Solvias for research purposes only. Patent WO 03084971. For detailed technical note visit strem.com .	100mg	

RHODIUM (Compounds)

45-0177	(+)-2,3-Bis[(2S,5S)-2,5-dimethylphospholanyl]-1-methyl-1H-pyrrole-2,5-dione(1,5-cyclooctadiene)rhodium(I) tetrafluoroborate, min. 98% [catASium® MN(S)Rh] Rh(C ₈ H ₁₂)(C ₁₇ H ₂₇ NO ₂ P ₂) ⁺ BF ₄ ⁻ ; FW: 637.24; red orange powdr. <i>air sensitive</i> Note: Optical purity: 95% Sold in collaboration with EVONIK for research purposes only. Patent WO 03084971. For detailed technical note visit strem.com .	100mg
45-0184	(2R,3R)-(-)-2,3-Bis(diphenylphosphino)bicyclo[2.2.1]hept-5-ene(1,5-cyclooctadiene)rhodium(I) tetrafluoroborate, min. 97% (R,R)-NORPHOS-Rh (521272-85-5) [Rh(C ₈ H ₁₂)(C ₃₁ H ₂₈ P ₂) ⁺ BF ₄ ⁻]; FW: 760.39; red-orange powdr. <i>air sensitive</i> For detailed technical note visit strem.com .	100mg 500mg
45-0185	(2S,3S)-(+)-2,3-Bis(diphenylphosphino)bicyclo[2.2.1]hept-5-ene(1,5-cyclooctadiene)rhodium(I) tetrafluoroborate, min. 97% (S,S)-NORPHOS-Rh (78355-59-6) [Rh(C ₈ H ₁₂)(C ₃₁ H ₂₈ P ₂) ⁺ BF ₄ ⁻]; FW: 760.39; red-orange powdr. <i>air sensitive</i> Note: Manufactured under license of Takasago patent application PCT/JP2011/064490. For detailed technical note visit strem.com .	100mg 500mg
45-0190	1,4-Bis(diphenylphosphino)butane(1,5-cyclooctadiene)rhodium(I) tetrafluoroborate, dichloromethane adduct, min. 98% (79255-71-3) [Rh(C ₈ H ₁₂)(C ₂₈ H ₂₈ P ₂) ⁺ BF ₄ ⁻ ·CH ₂ Cl ₂]; FW: 724.36 (809.29); orange powdr. <i>air sensitive</i> For detailed technical note visit strem.com .	100mg 500mg
45-0217	(R)-(-)-4,12-Bis(diphenylphosphino)[2.2]paracyclophane(1,5-cyclooctadiene)rhodium(I) tetrafluoroborate, min. 97% (849950-56-7) C ₄₈ H ₄₆ BF ₄ P ₂ Rh; FW: 874.54; yellow-orange solid <i>air sensitive</i> Note: Sold in collaboration with JM for research purposes only. For detailed technical note visit strem.com .	100mg 500mg
45-0218	(S)-(+)-4,12-Bis(diphenylphosphino)[2.2]paracyclophane(1,5-cyclooctadiene)rhodium(I) tetrafluoroborate, min. 97% (200808-73-7) C ₄₈ H ₄₆ BF ₄ P ₂ Rh; FW: 874.54 <i>air sensitive</i> Note: Sold in collaboration with JM for research purposes only. For detailed technical note visit strem.com .	100mg 500mg
45-0201	(-)-1,2-Bis((2R,5R)-2,5-diphenylphospholano)ethane(1,5-cyclooctadiene)rhodium(I) tetrafluoroborate, min. 98% (R,R)-Ph-BPE-Rh (528565-84-6) [Rh(C ₈ H ₁₂)(C ₃₄ H ₃₆ P ₂) ⁺ BF ₄ ⁻]; FW: 804.49; orange xtl. <i>air sensitive</i> Note: (R,R)-Duphos and BPE Rhodium Catalysts Kit component. For detailed technical note visit strem.com .	100mg 500mg 2g
45-0202	(+)-1,2-Bis((2S,5S)-2,5-diphenylphospholano)ethane(1,5-cyclooctadiene)rhodium(I) tetrafluoroborate, min. 98% (S,S)-Ph-BPE-Rh (849950-53-4) [Rh(C ₈ H ₁₂)(C ₃₄ H ₃₆ P ₂) ⁺ BF ₄ ⁻]; FW: 804.49; orange xtl. <i>air sensitive</i> Note: (S,S)-Duphos and BPE Rhodium Catalysts Kit component. For detailed technical note visit strem.com .	100mg 500mg 2g

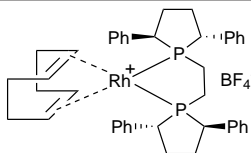
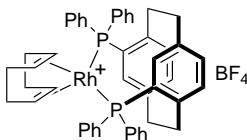
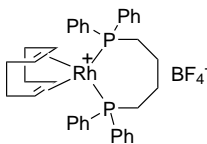

RHODIUM (Compounds)

45-0205	1,1'-Bis(di-i-propylphosphino)ferrocene(1,5-cyclooctadiene)rhodium(I) tetrafluoroborate, min. 98% (157772-65-1) $[(C_3H_7)_2PC_5H_4]_2Fe(C_8H_{12})Rh^+BF_4^-$; FW: 716.22; orange-brown powdr. <i>air sensitive</i> For detailed technical note visit strem.com .		250mg 1g
45-0210	(+)-1,2-Bis((2R,5R)-2,5-di-i-propylphospholano)benzene(1,5-cyclooctadiene)rhodium(I) tetrafluoroborate, min. 98% (R,R)-i-Pr-DUPHOS-Rh (569650-64-2) $[Rh(C_8H_{12})(C_{26}H_{44}P_2)]^+BF_4^-$; FW: 716.47; red-orange xtl. <i>air sensitive</i> Note: Manufactured under US Patent 5,021,131 and US Patent 5,171,892. (R,R)-Duphos and BPE Rhodium Catalysts Kit component. For detailed technical note visit strem.com .		100mg 500mg 2g
45-0211	(-)-1,2-Bis((2S,5S)-2,5-di-i-propylphospholano)benzene(1,5-cyclooctadiene)rhodium(I) tetrafluoroborate, min. 98% (S,S)-i-Pr-DUPHOS-Rh (569650-64-2) $[Rh(C_8H_{12})(C_{26}H_{44}P_2)]^+BF_4^-$; FW: 716.47; red-orange xtl. <i>air sensitive</i> Note: Manufactured under US Patent 5,021,131 and US Patent 5,171,892. (S,S)-Duphos and BPE Rhodium Catalysts Kit component. For detailed technical note visit strem.com .		100mg 500mg 2g
45-3021	1,2-Bis((2R,5R)-2,5-di-i-propylphospholano)ethane(cyclooctadiene)rhodium(I) tetrafluoroborate (136705-72-1) $C_{30}H_{56}BF_4P_2Rh$; FW: 668.42; orange-red solid <i>air sensitive</i> Note: Sold under license from Kanata for research purposes only.		100mg 500mg
45-3022	1,2-Bis((2S,5S)-2,5-di-i-propylphospholano)ethane(cyclooctadiene)rhodium(I) tetrafluoroborate (213343-67-0) $C_{30}H_{56}BF_4P_2Rh$; FW: 668.42; orange-red solid <i>air sensitive</i> Note: Sold under license from Kanata for research purposes only.		100mg 500mg
45-0328	1,1'-Bis((2R,5R)-2,5-di-i-propylphospholano)ferrocene(cyclooctadiene)rhodium(I) tetrafluoroborate (849773-96-2) $C_{38}H_{60}BF_4FeP_2Rh$; FW: 824.39; orange-red solid <i>air sensitive</i> Note: Sold under license from Kanata for research purposes only.		100mg 500mg
45-3029	1,1'-Bis((2S,5S)-2,5-di-i-propylphospholano)ferrocene(cyclooctadiene)rhodium(I) tetrafluoroborate (854920-94-8) $C_{38}H_{60}BF_4FeP_2Rh$; FW: 824.39; orange-red solid <i>air sensitive</i> Note: Sold under license from Kanata for research purposes only.		100mg 500mg
45-0213	(R)-(-)-4,12-Bis(di-3,5-xylylphosphino)[2.2]paracyclophane(1,5-cyclooctadiene)rhodium(I) tetrafluoroborate, min. 97% (619334-93-9) $[C_{36}H_{62}P_2Rh]^+BF_4^-$; FW: 986.75; yellow-orange xtl. <i>air sensitive</i> Note: Sold in collaboration with Johnson Matthey for research purposes only. Patent WO 2006/067412, US5874629. For detailed technical note visit strem.com .		100mg

RHODIUM (Compounds)

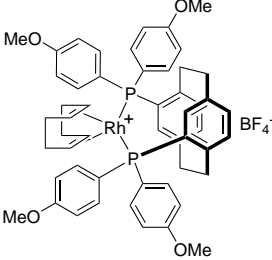
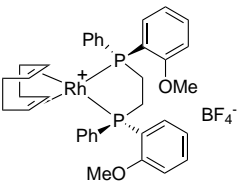
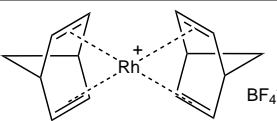
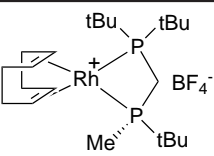
45-0214	(S)(+)-4,12-Bis(di-3,5-xylylphosphino)[2.2]paracyclophane(1,5-cyclooctadiene)rhodium(I) tetrafluoroborate, min. 97% (1174218-30-4) [C ₅₂ H ₆₂ P ₂ Rh] ⁺ BF ₄ ⁻ ; FW: 986.75; yellow-orange xtl. <i>air sensitive</i> Note: Sold in collaboration with Johnson Matthey for research purposes only. Patent WO 2006/067412, US5874629. For detailed technical note visit strem.com .	100mg
45-0255	(R)-4,12-Bis(4-methoxyphenyl)-[2.2]-paracyclophane(1,5-cyclooctadiene)rhodium(I) tetrafluoroborate, min. 97% (1038932-67-0) C ₅₂ H ₅₄ BF ₄ O ₄ P ₂ Rh; FW: 994.64 <i>air sensitive</i> Note: Sold in collaboration with JM for research purposes only. For detailed technical note visit strem.com .	100mg 500mg
		
45-0256	(S)-4,12-Bis(4-methoxyphenyl)-[2.2]-paracyclophane(1,5-cyclooctadiene)rhodium(I) tetrafluoroborate, min. 97% C ₅₂ H ₅₄ BF ₄ O ₄ P ₂ Rh; FW: 994.64 <i>air sensitive</i> Note: Sold in collaboration with JM for research purposes only. For detailed technical note visit strem.com .	100mg 500mg
45-0225	(R,R)-(-)-1,2-Bis[(o-methoxyphenyl)(phenyl)phosphino]ethane(1,5-cyclooctadiene)rhodium(I) tetrafluoroborate, min. 95% (56977-92-5) [(C ₂₈ H ₂₈ O ₂ P ₂)(C ₈ H ₁₂ Rh)] ⁺ BF ₄ ⁻ ; FW: 756.38; orange powdr. <i>air sensitive</i> For detailed technical note visit strem.com .	100mg 500mg
		
45-0226	(S,S)-(+)-1,2-Bis[(o-methoxyphenyl)(phenyl)phosphino]ethane(1,5-cyclooctadiene)rhodium(I) tetrafluoroborate, min. 95% (71423-54-6) [Rh(C ₈ H ₁₂)(C ₂₈ H ₂₈ O ₂ P ₂)] ⁺ BF ₄ ⁻ ; FW: 756.38; orange powdr. <i>air sensitive</i> For detailed technical note visit strem.com .	100mg 500mg
45-0230	Bis(norbornadiene)rhodium(I) tetrafluoroborate, min. 96% (36620-11-8) Rh(C ₇ H ₈) ₂ ⁺ BF ₄ ⁻ ; FW: 373.99; red solid <i>air sensitive, (store cold)</i> For detailed technical note visit strem.com .	250mg 1g 5g
		
45-0655	NEW Bromotris(triphenylphosphine)rhodium(I), 99% (99.9%-Rh) (14973-89-8) C ₅₄ H ₄₅ BrP ₃ Rh; FW: 969.67 For detailed technical note visit strem.com .	250mg 1g 5g
45-0667	(R)-(-)-t-Butylmethyl(di-t-butylphosphinomethyl)phosphino(1,5-cyclooctadiene)rhodium(I) tetrafluoroborate, min. 97% (R)-TCFP-Rh (705945-70-6) Rh(C ₈ H ₁₂)(C ₁₄ H ₃₂ P ₂) ⁺ BF ₄ ⁻ ; FW: 560.24; yellow to orange powdr. <i>air sensitive</i> Note: Sold in collaboration with Johnson Matthey for research purposes only. Patent WO 2005087370. For detailed technical note visit strem.com .	100mg 500mg
		

RHODIUM (Compounds)

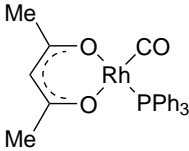
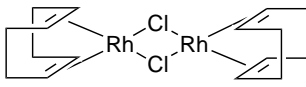
45-0355 NEW	Carbonyl(acetylacetonato)(triphenylphosphine) rhodium(I), 99% (25470-96-6) $C_{24}H_{22}O_3PRh$; FW: 492.31; yellow solid For detailed technical note visit strem.com .		250mg 1g 5g
96-7650	CATHy™ Catalyst Kit for Asymmetric Transfer Hydrogenation of Ketones and Imines See page 476		
45-0265	Chlorobis(cyclooctene)rhodium(I) dimer, min. 98% (12279-09-3) $[RhCl(C_8H_{14})_2]_2$; FW: 717.50; orange to red xtl. <i>air sensitive, (store cold)</i>		250mg 1g
45-0270	Chlorobis(ethylene)rhodium(I) dimer, 99% (12081-16-2) $[RhCl(C_2H_4)_2]_2$; FW: 388.93; rust-colored powdr. <i>air sensitive, (store cold)</i>		250mg 1g 5g
45-0350	Chlorocarbonylbis(triphenylphosphine)rhodium(I), 99% (13938-94-8) $RhCl(CO)(P(C_6H_5)_3)_2$; FW: 690.93; yellow xtl.; m.p. 170° dec.		250mg 1g 5g
45-0380	Chloro(1,5-cyclooctadiene)rhodium(I) dimer, 98% (12092-47-6) $[RhCl(1,5-C_8H_{12})_2]_2$; FW: 493.08; yellow to orange xtl. <i>hygroscopic</i> For detailed technical note visit strem.com .		250mg 1g 5g
45-0450	Chlorodicarbonylrhodium(I) dimer (14523-22-9) $[RhCl(CO)_2]_2$; FW: 388.76; red xtl.; m.p. 124-125° <i>air sensitive, (store cold)</i> For detailed technical note visit strem.com .		100mg 500mg 2g
45-0385	Chloro[2-methyl{1S,2S-diphenyl-2-[(4-amidophenylsulfonyl)amido]ethyl}amino]phenyl]-2,3,4,5-tetramethylcyclopentadienyl]rhodium(III) Heterogenized Rh(III)-catalyst on a polyethylene sinter plate yellow-orange plate (1cm x 1cm x 1.5mm) Note: Sold under license from PolyAn for research purposes only. PCT/EP2010/060270 **Limited quantities available*		100mg 500mg

Technical Notes:

1. Catalytic generation of enantioenriched compounds.
2. Simple catalyst separation and recycling - continuously operated reactions possible.
3. Water as a solvent.
4. Formate as hydrogen donor - non-toxic, safe, easy to handle.
5. Irreversible hydrogen transfer (essentially no reverse reaction through the generation of CO_2).

Rhodium content: 0.05 mass%
Support material: Polyethylene
Weight of one plate: 100mg
Mean Particle Size: 30 microns

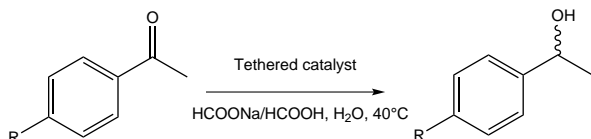

R = H, Cl, NO_2 , OMe

References:

1. *Org. Lett.*, **2005**, 7, 5489.
2. *Advanced Synthesis & Catalysis*, **2010**, 352(14-15), 2497.
3. *Synfacts*, **2010**, 1, 112.
4. *Advanced Synthesis & Catalysis*, **2011**, 353, 8, 1335

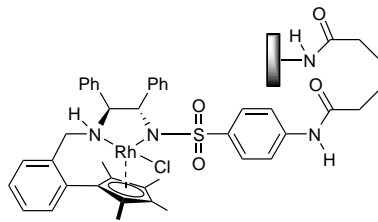

RHODIUM (Compounds)

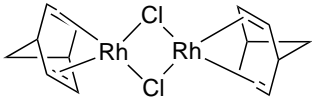
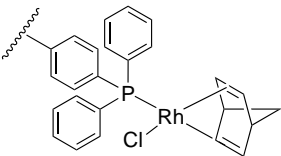
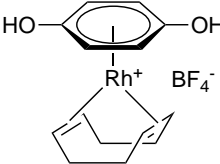
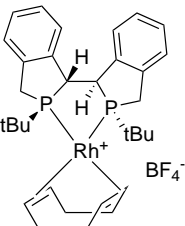
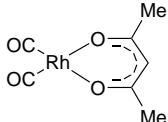
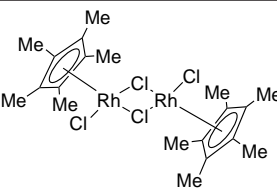
45-0500	Chloronorbornadiene rhodium(I) dimer, 99% (12257-42-0) [RhCl(C ₆ H ₈) ₂] ₂ ; FW: 461.00; yellow to orange powdr.		250mg 1g
45-1700	Chloronorbornadienetriphenylphosphinerhodium(I) (~5% Rh) polymer-bound FibreCat™ yellow, fibrous solid <i>air sensitive</i> Note: Limited quantities available.		5g
Technical Note: 1. Versatile polymer-bound catalyst used for the selective hydrogenation of polyolefins. The supported rhodium catalyst exhibits similar selectivity to its homogeneous counterpart. In most cases, rhodium leaching is negligible.			
45-0600	Chloropentaamminerhodium(III) chloride, 99% (13820-95-6) [Rh(NH ₃) ₅ Cl]Cl ₂ ; FW: 294.43; golden yellow xtl.		1g 5g
45-0650	Chlorotris(triphenylphosphine)rhodium(I), 99% WILKINSON'S CATALYST (14694-95-2) RhCl(P(C ₆ H ₅) ₃) ₃ ; FW: 925.23; maroon xtl. For detailed technical note visit strem.com .		250mg 1g 5g
45-0652	1,5-Cyclooctadiene(hydroquinone)rhodium(I) tetrafluoroborate (120967-70-6) [Rh(C ₈ H ₁₂)(C ₆ H ₆ O ₂)] ⁺ BF ₄ ⁻ ; FW: 408.00; yellow powdr. Note: Sold in collaboration with Brown University for research purposes only. Commercial use requires a license. US Patent Application 11/454,760. For detailed technical note visit strem.com .		250mg 1g
45-0663	(1R,1'R,2S,2'S)-(+)-2,2'-Di-t-butyl-2,3,2',3'-tetrahydro-1,1'-bi-1H-isophosphindole(1,5-cyclooctadiene)rhodium(I) tetrafluoroborate, min. 98% (R,R,S,S)-DUANPHOS-Rh [Rh(C ₈ H ₁₂)(C ₂₄ H ₃₂ P ₂) ₂] ⁺ BF ₄ ⁻ ; FW: 680.35; orange xtl. <i>air sensitive</i> Note: Sold in collaboration with Chiral Quest for research purposes only. US Patent No. 7105702, 7153809, 7169953. Chiral Quest Catalyst and Ligand Toolbox Kit component. For detailed technical note visit strem.com .		100mg
45-0700	Dicarbonylacetylacetonato rhodium(I), 99% (14874-82-9) Rh(CO) ₂ (C ₅ H ₇ O ₂); FW: 258.04; greenish-red xtl.; m.p. 144-147° subl. For detailed technical note visit strem.com .		250mg 1g 5g
45-0739	Dicarbonyl(pentamethylcyclopentadienyl)rhodium(I), 99% (99.9%-Rh) (32627-01-3) (CH ₃) ₅ C ₅ Rh(CO) ₂ ; FW: 294.16; red xtl. <i>air sensitive, (store cold)</i>		100mg 500mg
45-0195	Dichloro(pentamethylcyclopentadienyl)rhodium(III) dimer, 99% (12354-85-7) [(CH ₃) ₅ C ₅ RhCl ₂] ₂ ; FW: 618.08; red xtl. Note: CATHY™ Catalyst Kit component. For detailed technical note visit strem.com .		100mg 500mg 2g

RHODIUM (Compounds)

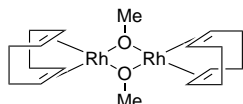
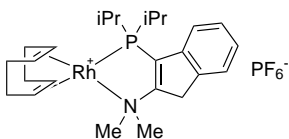
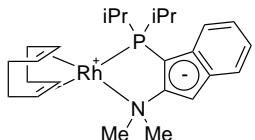
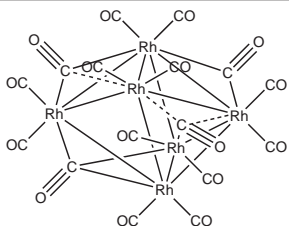
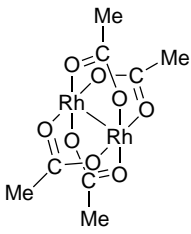
45-0390	Di-μ-methoxobis(1,5-cyclooctadiene)dirhodium(I), min. 98% (12148-72-0) [Rh(OCH ₃)(C ₈ H ₁₂) ₂] ₂ ; FW: 484.24; yellow powdr.		50mg 250mg 1g
45-0198	3-Di-i-propylphosphino-2-(N,N-dimethylamino)-1H-indene(1,5-cyclooctadiene)rhodium(I) hexafluorophosphate, min. 98% [RhC ₂₅ H ₃₈ NP] ⁺ PF ₆ ⁻ ; FW: 631.42; orange powdr. For detailed technical note visit strem.com.		250mg 1g
45-0197	3-Di-i-propylphosphoranylidene-2-(N,N-dimethylamino)-1H-indene(1,5-cyclooctadiene)rhodium(I), min. 95% (540492-55-5) C ₂₅ H ₃₇ NPRh; FW: 485.45; orange-red xtl. For detailed technical note visit strem.com.		250mg 1g
96-4730	(R,R)-Duphos and BPE Rhodium Catalyst Kit for Asymmetric Hydrogenation See page 479		
96-4731	(S,S)-Duphos and BPE Rhodium Catalyst Kit for Asymmetric Hydrogenation See page 480		
45-0820	Hexarhodium hexadecacarbonyl, min. 98% (28407-51-4) Rh ₆ (CO) ₁₆ ; FW: 1065.61; black xtl.; d. 2.87		250mg 1g
45-0900	Hydridocarbonyltris(triphenylphosphine)rhodium(I), 98% (17185-29-4) RhH(CO)(P(C ₆ H ₅) ₃) ₃ ; FW: 918.79; light yellow xtl.; m.p. 138° dec. <i>air sensitive</i>		250mg 1g 5g
45-0915	Hydridotetrakis(triphenylphosphine)rhodium(I), 99% (18284-36-1) RhH[P(C ₆ H ₅) ₃] ₄ ; FW: 1153.06; yellow microxtl. For detailed technical note visit strem.com.		250mg 1g
45-1000	Hydroxy(1,5-cyclooctadiene)rhodium(I) dimer, min. 97% (73468-85-6) [RhOH(C ₈ H ₁₂) ₂] ₂ ; FW: 456.19; yellow powdr.		250mg 1g
45-0670	Polymer-bound chlorotris(triphenylphosphine)rhodium(I) on styrene-divinylbenzene copolymer (20% cross-linked) (14694-95-2) maroon beads; 20-60 mesh <i>air sensitive</i> For detailed technical note visit strem.com.		1g 5g
45-1715	Potassium hexanitrorhodate(III), min. 97% (17712-66-2) See page 342		
45-1730	Rhodium(II) acetate dimer, 99% (15956-28-2) Rh ₂ (OOCCH ₃) ₄ ; FW: 442.00; greenish-black xtl. For detailed technical note visit strem.com.		100mg 500mg 2g 25g
45-1800	Rhodium(III) acetylacetonate, 97+% (99.9%-Rh) (14284-92-5) Rh(C ₅ H ₇ O ₂) ₃ ; FW: 400.24; yellow xtl.; m.p. 260°; b.p. dec. >280° (subl. 240°/0.1mm)		250mg 1g 5g

RHODIUM (Compounds)

45-1876	Rhodium(III) bromide dihydrate (15608-29-4) RhBr ₃ ·2H ₂ O; FW: 342.63 (378.66); brown to black xtl.	500mg 2g
45-1878	Rhodium(III) chloride, anhydrous (10049-07-7) RhCl ₃ ; FW: 209.28; red powdr.; m.p. 450° dec. <i>hygroscopic</i> For detailed technical note visit strem.com .	250mg 1g 5g
45-1880	Rhodium(III) chloride hydrate (38-41% Rh) (20765-98-4) RhCl ₃ ·XH ₂ O; FW: 209.28; dark red powdr.; m.p. 100° (dec.) <i>hygroscopic</i> For detailed technical note visit strem.com .	250mg 1g 5g 25g
45-1805	Rhodium(III) iodide (99.9+% Rh) (15492-38-3) RhI ₃ ; FW: 483.62; black powdr. <i>hygroscopic</i>	250mg 1g 5g
45-1808 HAZ	Rhodium(III) nitrate, solution in water (10% Rh) (10139-58-9) Rh(NO ₃) ₃ ; FW: 288.60; amber liq.	1g 5g 25g
45-1809	Rhodium(II) octanoate dimer, 98% (73482-96-9) [Rh(C ₇ H ₁₅ COO) ₂] ₂ ; FW: 778.64; green powdr.	500mg 1g 5g
45-1865	Rhodium(III) oxide, anhydrous (99.9% Rh) (12036-35-0) Rh ₂ O ₃ ; FW: 253.81; gray powdr.; m.p. 1100° dec.; d. 8.20	500mg 2g
45-1866	Rhodium(III) oxide pentahydrate, 99% (39373-27-8) Rh ₂ O ₃ ·5H ₂ O; FW: 253.81 (343.89); yellow powdr.; m.p. dec.	250mg 1g
45-1960	Rhodium(II) trifluoroacetate dimer, min. 95% (31126-95-1) Rh ₂ (OOCFCF ₃) ₄ ; FW: 657.88; green powdr. <i>hygroscopic</i>	100mg 500mg 2g
45-2000	Sodium hexachlororhodate(III) hydrate (14972-70-4) See page 418	
45-2070	Tetrakis[(R)-(-)-(1-adamantyl)-(N-phthalimido)acetato]dirhodium(II) Rh₂(R-PTAD)₄ (909393-65-3) C ₈₀ H ₈₀ N ₄ O ₁₆ Rh ₂ ; FW: 1559.32; green powdr. Note: Sold for research purposes only. US Patent Application 11/606,782. For detailed technical note visit strem.com .	50mg 250mg
45-2071	Tetrakis[(S)-(+)-(1-adamantyl)-(N-phthalimido)acetato]dirhodium(II) Rh₂(S-PTAD)₄ (909389-99-7) C ₈₀ H ₈₀ N ₄ O ₁₆ Rh ₂ ; FW: 1559.32; green powdr. Note: Sold for research purposes only. US Patent Application 11/606,782. For detailed technical note visit strem.com .	50mg 250mg
45-2080	Tetrakis[(R)-(-)-(1R)-1-(4-bromophenyl)-2,2-diphenylcyclopropanecarboxylato]dirhodium(II) Rh₂(R-BTP-CP)₄ (1345974-62-0) C ₈₈ H ₆₄ Br ₄ O ₈ Rh ₂ ; FW: 1774.87; green solid Note: Patent PCT/US2012/040608. For detailed technical note visit strem.com .	50mg 250mg
45-2081	Tetrakis[(S)-(+)-[(1S)-1-(4-bromophenyl)-2,2-diphenylcyclopropanecarboxylato]dirhodium(II) Rh₂(S-BTPCP)₄ (1345974-63-1) C ₈₈ H ₆₄ Br ₄ O ₈ Rh ₂ ; FW: 1774.87; green solid Note: Patent PCT/US2012/040608. For detailed technical note visit strem.com .	50mg 250mg

RHODIUM (Compounds)

45-2105 NEW	Tetrakis[5-<i>t</i>-butyl-phthaloyl-<i>N</i>-(<i>S</i>)-<i>tert</i>-leucinato]dirhodium bis(ethyl acetate) adduct Rh₂(<i>S</i>-<i>tert</i>PTTL)₄ (1884452-99-6) C ₇₂ H ₈₈ N ₄ O ₁₆ Rh ₂ ; FW: 1471.30; green pwdr. Note: Sold for research and development purposes only. Patent 2014. 2014903620. For detailed technical note visit strem.com .		50mg 250mg
45-2050	Tetrakis(1,5-cyclooctadiene)tetra-μ-hydridotetrarhodium, min. 98% (82660-97-7) [Rh(C₈H₁₂)₄]₄ ; FW: 848.38; red xtl. <i>air sensitive</i>		100mg 500mg
45-2100	Tetrakis[(<i>R</i>)-(+)-<i>N</i>-(<i>p</i>-dodecylphenylsulfonyl)prolinato]dirhodium(II) Rh₂(<i>R</i>-DOSP)₄ (178879-60-2) [C ₂₃ H ₃₆ NO ₄ S] ₄ Rh ₂ ; FW: 1896.22; green pwdr. Note: Sold under license for research purposes. For detailed technical note visit strem.com .	<p style="text-align: center;">Ar = <i>p</i>-C₁₂H₂₅C₆H₄</p>	50mg 250mg
45-2101	Tetrakis[(<i>S</i>)-(-)-<i>N</i>-(<i>p</i>-dodecylphenylsulfonyl)prolinato]dirhodium(II) Rh₂(<i>S</i>-DOSP)₄ (179162-34-6) [C ₂₃ H ₃₆ NO ₄ S] ₄ Rh ₂ ; FW: 1896.22; green pwdr. Note: Sold under license for research purposes. For detailed technical note visit strem.com .		50mg 250mg
45-2110	(<i>R</i>)-(+)-2,2',6,6'-Tetramethoxy-4,4'-bis(diphenylphosphino)-3,3'-bipyridine(1,5-cyclooctadiene)rhodium(I) tetrafluoroborate, min. 97% (573718-56-6) [C ₄₆ H ₄₆ N ₂ O ₄ P ₂ Rh] ⁺ BF ₄ ⁻ ; FW: 942.53; yellow-orange xtl. <i>air sensitive</i> Note: Sold in collaboration with Johnson Matthey for research purposes only. Patent US5886182. For detailed technical note visit strem.com .		100mg
45-2111	(<i>S</i>)-(-)-2,2',6,6'-Tetramethoxy-4,4'-bis(diphenylphosphino)-3,3'-bipyridine(1,5-cyclooctadiene)rhodium(I) tetrafluoroborate, min. 97% (1174131-02-2) [C ₄₆ H ₄₆ N ₂ O ₄ P ₂ Rh] ⁺ BF ₄ ⁻ ; FW: 942.53; yellow-orange xtl. <i>air sensitive</i> Note: Sold in collaboration with Johnson Matthey for research purposes only. Patent US5886182. For detailed technical note visit strem.com .		100mg

RHODIUM (Compounds)

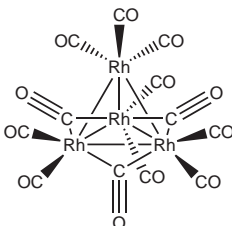
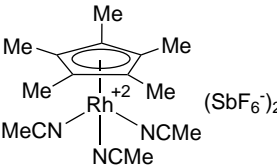
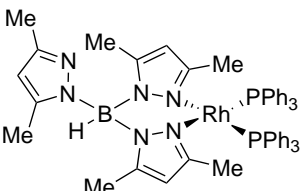
45-2150	Tetrarhodium dodecacarbonyl, min. 98% (19584-30-6) Rh ₄ (CO) ₁₂ ; FW: 747.75; dark red xtl.; d. 2.52 <i>air sensitive, light sensitive, (store cold)</i>		50mg 250mg 1g
45-2160	Tris(acetonitrile)pentamethylcyclopentadienylrhodium(III) hexafluoroantimonate, min. 98% (59738-27-1) [Rh(C ₅ H ₅ Me ₅)(CH ₃ CN) ₃] ⁺ (SbF ₆) ₂ ⁻ ; FW: 832.79; light yellow powdr. For detailed technical note visit strem.com .		50mg 250mg 1g
45-0275	[Tris(3,5-dimethyl-1H-pyrazolato)hydroborato]bis(triphenylphosphine)rhodium(I) toluene adduct, 99% (341483-76-9) C ₅₁ H ₅₂ BN ₆ P ₂ Rh; FW: 924.66; red xtl.		50mg 250mg

RUBIDIUM (Elemental Forms)

93-3735	Rubidium (99+% (prescored ampoule) (7440-17-7) amp Rb; FW: 85.47; under argon; m.p. 38.9°; b.p. 688°; d. 1.532 HAZ <i>moisture sensitive, pyrophoric</i>	1g 5g
37-3736	Rubidium (99.9+% (breakseal ampoule) (7440-17-7) amp Rb; FW: 85.47; under argon; m.p. 38.9°; b.p. 688°; d. 1.532 HAZ <i>moisture sensitive, pyrophoric</i>	1g 5g
93-3736	Rubidium (99.9+% (prescored ampoule) (7440-17-7) amp Rb; FW: 85.47; under argon; m.p. 38.9°; b.p. 688°; d. 1.532 HAZ <i>moisture sensitive, pyrophoric</i>	1g 5g 25g 50g

RUBIDIUM (Compounds)

93-3701	Rubidium acetate (99%-Rb) (563-67-7) RbOOCCH ₃ ; FW: 144.52; white xtl.; m.p. 246° <i>hygroscopic</i>	10g 50g
93-3720	Rubidium bromide (99%-Rb) (7789-39-1) RbBr; FW: 165.38; white xtl.; m.p. 682°; b.p. 1340°; d. 3.35 <i>hygroscopic</i>	10g 50g
93-3726	Rubidium bromide (99.9%-Rb) (7789-39-1) RbBr; FW: 165.38; white xtl.; m.p. 682°; b.p. 1340°; d. 3.35 <i>hygroscopic</i>	5g 25g
93-3703	Rubidium carbonate (99%-Rb) (584-09-8) Rb ₂ CO ₃ ; FW: 230.95; white xtl.; m.p. 837°	10g 50g
93-3725	Rubidium carbonate (99.8+%-Rb) (584-09-8) Rb ₂ CO ₃ ; FW: 230.95; white powdr.; m.p. 837°	5g 25g
93-3705	Rubidium chloride (99%-Rb) (7791-11-9) RbCl; FW: 120.92; white xtl.; m.p. 715°; b.p. 1390°; d. 2.80 <i>hygroscopic</i>	10g 50g
93-3704	Rubidium chloride (99.8%-Rb) (7791-11-9) RbCl; FW: 120.92; white xtl.; m.p. 715°; b.p. 1390°; d. 2.80 <i>hygroscopic</i>	10g 50g

RUBIDIUM (Compounds)

93-3730 HAZ	Rubidium fluoride, anhydrous (99.8%-Rb) (13446-74-7) RbF; FW: 104.47; white powdr.; m.p. 775°; b.p. 1410°; d. 3.557 <i>hygroscopic</i>	5g 25g
93-3708 HAZ	Rubidium hydroxide, 50% aqueous solution (99+%-Rb) (1310-82-3) RbOH; FW: 102.48; colorless liq. <i>air sensitive</i>	5g 25g 100g
93-3721 HAZ	Rubidium hydroxide hydrate, fused solid (99.8%-Rb) (12026-05-0) RbOH·XH ₂ O; FW: 102.48; white powdr.; m.p. 300-302°; d. 3.203 <i>hygroscopic</i>	5g 25g
93-3710	Rubidium iodide, 99% (7790-29-6) RbI; FW: 212.37; white xtl.; m.p. 642°; b.p. 1300°; d. 3.55 <i>hygroscopic</i>	10g 50g
93-3709	Rubidium iodide (99.8%-Rb) (7790-29-6) RbI; FW: 212.37; white xtl.; m.p. 642°; b.p. 1300°; d. 3.55 <i>hygroscopic</i>	5g 25g
93-3711 HAZ	Rubidium nitrate (99%-Rb) (13126-12-0) RbNO ₃ ; FW: 147.47; white xtl.; d. 3.11 <i>hygroscopic</i>	10g 50g
93-3713 HAZ	Rubidium perchlorate, anhydrous (99.9%-Rb) (13510-42-4) RbClO ₄ ; FW: 184.92; white xtl.; d. 2.80 <i>hygroscopic</i>	10g 50g
93-3714	Rubidium sulfate (99.8%-Rb) (7488-54-2) Rb ₂ SO ₄ ; FW: 267.00; white xtl.; m.p. 1050°; b.p. ~1700°; d. 3.613	10g 50g
37-5000	2,2,6,6-Tetramethyl-3,5-heptanedionato rubidium [Rb(TMHD)] (166439-15-2) RbC ₁₁ H ₁₉ O ₂ ; FW: 268.74; white to off-white powdr.	1g 5g 25g

RUTHENIUM (Elemental Forms)

78-0062	Platinum-ruthenium/tetra-n-octylammonium chloride colloid (~7 wt% Pt, ~3.5 wt% Ru) (7440-06-4) <i>See page 162</i>	
44-4065	Ruthenium, 5% on activated carbon, reduced, 50% water wet paste (Escat™ 4401) (7440-18-8) black powdr. (d ₅₀ =18 μm); SA: 900m ² /g Note: Sold in collaboration with BASF for research purposes only. BASF Heterogeneous Catalyst Kit component.	5g 25g
44-4060	Ruthenium, 5% on activated carbon, (50-70% wetted powder) Evonik Noblyst® P3060 (7440-18-8) wetted, black powdr. Note: Sold in collaboration with Evonik for research purposes only. Evonik Heterogeneous Catalyst Kit component. Evonik Heterogeneous Catalyst Kit for Selective Hydrogenation component.	10g 50g
44-3880	Ruthenium, 0.5% on alumina (7440-18-8) Ru on alumina; 1/8" x 1/8" pellets; SA: ~100 m ² /g	25g 100g
44-3910	Ruthenium, 5% on alumina (7440-18-8) Ru on alumina; powdr.; SA: 80-100 m ² /g; P.Vol. 0.40 cc/g	25g 100g
44-3000 HAZ	Ruthenium black (99.9%) (7440-18-8) Ru; FW: 101.07; powdr.; m.p. 2310°; b.p. 3900°; d. 12.3	500mg 2g 10g
44-4000 HAZ	Ruthenium, 0.5% on carbon (7440-18-8) Ru on carbon; 4-12 mesh gran.; SA: ~1000 m ² /g	25g 100g
44-4050 HAZ	Ruthenium, 5% on carbon (7440-18-8) Ru on carbon; powdr.	5g 25g 100g
	Ruthenium nanoparticles - surfactant and reactant-free (pure), manufactured via laser ablation (7440-18-8) <i>See page 165</i>	

RUTHENIUM (Elemental Forms)

44-4275	Ruthenium powder (99.9%) (7440-18-8)	1g
HAZ	Ru; FW: 101.07; -200 mesh bluish-gray powdr.; m.p. 2310°; b.p. 3900°; d. 12.3	5g
44-4270	Ruthenium powder (99.9%) (7440-18-8)	1g
HAZ	Ru; FW: 101.07; -325 mesh bluish-gray powdr.; m.p. 2310°; b.p. 3900°; d. 12.3	5g
44-4300	Ruthenium powder (99.95%) (7440-18-8)	1g
HAZ	Ru; FW: 101.07; -325 mesh bluish-gray powdr.; m.p. 2310°; b.p. 3900°; d. 12.3	5g
44-4350	Ruthenium powder (99.99%) (7440-18-8)	1g
HAZ	Ru; FW: 101.07; -200 mesh powdr.; m.p. 2310°; b.p. 3900°; d. 12.3	5g

RUTHENIUM (Compounds)

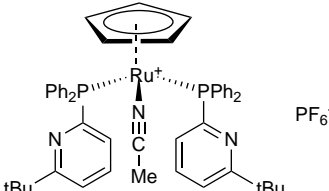
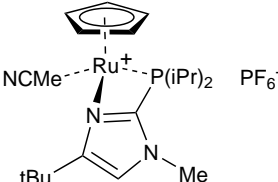
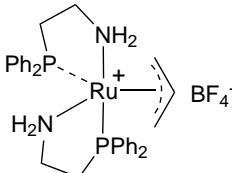
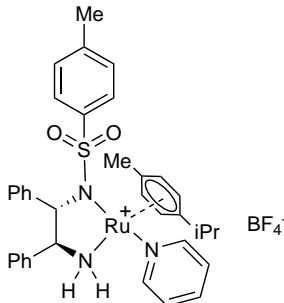
44-0010	Acetato dicarbonylruthenium, polymer (26317-70-4)	1g
	[Ru(CO) ₂ CH ₃ COO] _n ; FW: (216.14) _n ; orange powdr.	5g
44-0015	Acetonitrilebis[2-diphenylphosphino-6-t-butylpyridine]cyclopentadienylruthenium(II) hexafluorophosphate, min. 98% (776230-17-2)	250mg
	Ru(C ₅ H ₅)(CH ₃ CN)[C ₂₁ H ₂₂ NP ₂] ₂ ·PF ₆ ⁻ ; FW: 990.94; yellow microxtl. <i>air sensitive</i> For detailed technical note visit strem.com .	1g
		
44-0017	Acetonitrile(cyclopentadienyl)[2-(di-i-propylphosphino)-4-(t-butyl)-1-methyl-1H-imidazole]ruthenium(II) hexafluorophosphate, min. 98% [Alkene Zipper Catalyst] (930601-66-4)	100mg
	C ₂₁ H ₃₅ F ₆ N ₃ P ₂ Ru; FW: 606.53; orange solid <i>air sensitive, (store cold)</i> For detailed technical note visit strem.com .	500mg
		
44-6085	Allylbis(2-aminoethyl)diphenylphosphino)ruthenium(II) tetrafluoroborate, 98% (1352633-94-3)	100mg
NEW	C ₃₁ H ₃₇ BF ₄ N ₂ P ₂ Ru; FW: 687.46; off-white to pale yellow solid Note: Sold in collaboration with GreenCentre for research purposes only. Patents: PCT/2013/010275. For detailed technical note visit strem.com .	500mg
		
44-6078	{[(1R,2R)-2-Amino-1,2-diphenylethyl](4-toluenesulfonylamido)}(p-cymene)pyridine)ruthenium(II) tetrafluoroborate, min. 97% (1192483-14-9)	100mg
	C ₃₆ H ₄₀ BF ₄ N ₃ O ₂ RuS; FW: 766.70; yellow-brown solid <i>air sensitive</i> Note: Sold under license from Kanata for research purposes only. WO 2009132443.	500mg
		

RUTHENIUM (Compounds)

44-6079	<p>[[[(1S,2S)-2-Amino-1,2-diphenylethyl](4-toluenesulfonyl)amido] (p-cymene)(pyridine)ruthenium(II) tetrafluoroborate, min. 97% (1192483-27-4)]</p> <p>$C_{36}H_{40}BF_4N_3O_2RuS$; FW: 766.70; yellow-brown solid <i>air sensitive</i></p> <p>Note: Sold under license from Kanata for research purposes only. WO 2009132443.</p>	100mg 500mg
44-6080	<p>[[[(1R,2R)-2-Amino-1,2-diphenylethyl] (4-toluenesulfonyl)amido] (p-cymene)(pyridine)ruthenium(II) tetrakis(pentafluorophenyl)borate, min. 97% (1192483-19-4)]</p> <p>$C_{60}H_{40}BF_{20}N_3O_2RuS$; FW: 1358.90; yellow brown solid <i>air sensitive</i></p> <p>Note: Sold under license from Kanata for research purposes only. WO 2009132443.</p>	100mg 500mg
44-6081	<p>[[[(1S,2S)-2-Amino-1,2-diphenylethyl](4-toluenesulfonyl)amido](p-cymene) (pyridine)ruthenium(II) tetrakis(pentafluorophenyl)borate, min. 97% (1192483-27-4)]</p> <p>$C_{60}H_{40}BF_{20}N_3O_2RuS$; FW: 1358.90; yellow-brown solid <i>air sensitive</i></p> <p>Note: Sold under license from Kanata for research purposes only. WO 2009132443.</p>	100mg 500mg
44-6075	<p>[[[(1R,2R)-2-Amino-1,2-diphenylethyl] (4-toluenesulfonyl)amido](p-cymene) ruthenium(II) tetrafluoroborate, min. 97% (1192483-03-6)]</p> <p>$C_{31}H_{35}BF_4N_2O_2RuS$; FW: 687.60; brown-purple solid <i>air sensitive</i></p> <p>Note: Sold under license from Kanata for research purposes only. WO 2009132443.</p>	100mg 500mg
44-6076	<p>[[[(1S,2S)-2-Amino-1,2-diphenylethyl](4-toluenesulfonyl)amido](p-cymene) ruthenium(II) tetrafluoroborate, min. 97% (1192483-26-3)]</p> <p>$C_{31}H_{35}BF_4N_2O_2RuS$; FW: 687.60; brown-purple solid <i>air sensitive</i></p> <p>Note: Sold under license from Kanata for research purposes only. WO 2009132443.</p>	100mg 500mg
44-0020	<p>Ammonium hexachlororuthenate(IV), 99% (18746-63-9) See page 5</p>	
96-0400	<p>Apeiron Ruthenium Metathesis Catalyst Kit See page 466</p>	
44-6200	<p>Bis(cyclopentadienyl)ruthenium, 99% (99.9%-Ru) (Ruthenocene) (1287-13-4) $(C_5H_5)_2Ru$; FW: 231.26; light yellow xtl.; m.p. 194-198°</p>	1g 5g

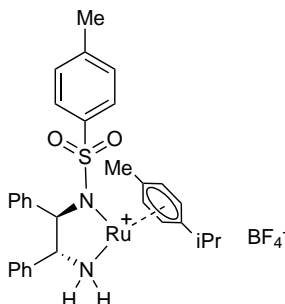
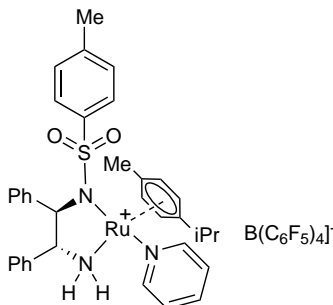

RUTHENIUM (Compounds)

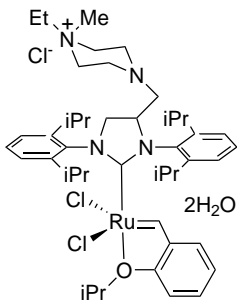
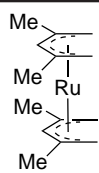
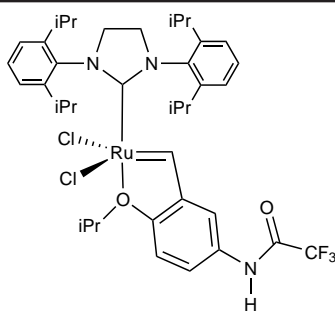
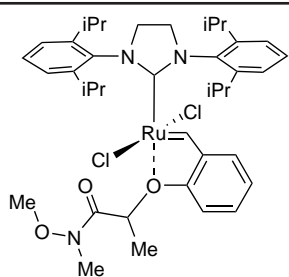
44-0759 NEW	<p>(1,3-Bis(2,6-diisopropylphenyl)-4-((4-ethyl-4-methylpiperzain-1-ium-1-yl)methyl)imidazolidin-2-ylidene)(2-isopropoxybenzylidene)ruthenium(II) chloride dihydrate FixCat (1799947-97-9) $C_{45}H_{67}Cl_2N_4ORuCl\ 2(H_2O)$; FW: 887.47 (923.50); green powdr. <i>(store cold)</i> Note: Sold in collaboration with Apeiron Synthesis, Inc. U.S. Patent 61/603,790; PCT/EP2013/053967 For detailed technical note visit strem.com.</p>		100mg 500mg
44-0030	<p>Bis(2,4-dimethylpentadienyl)ruthenium(II), 99% (85908-78-7) $(C_7H_{11})_2Ru$; FW: 291.39; yellow solid; m.p. 85° For detailed technical note visit strem.com.</p>		250mg 1g
44-0055	<p>[1,3-Bis(2,6-di-i-propylphenyl)-4,5-dihydroimidazol-2-ylidene]-[2-i-propoxy-5-(trifluoroacetamido)phenyl]methylenruthenium(II) dichloride M71-S1Pr (1212008-99-5) $C_{39}H_{50}Cl_2F_3N_3O_2Ru$; FW: 821.80; green powdr. Note: Sold under license from Omega Cat System for research purposes only WO 2008/065187, PCT/EP2008/054901, Fr n°08/05403. For detailed technical note visit strem.com.</p>		100mg 500mg
44-0750 NEW	<p>[1,3-Bis(2,6-di-i-propylphenyl)imidazolidin-2-ylidene][2-[[1-(methoxy(methyl)amino)-1-oxopropan-2-yl]oxy]benzylidene]ruthenium(II) dichloride GreenCat (1448663-06-6) $C_{39}H_{53}Cl_2N_3O_3Ru$; FW: 783.33; green powdr. Note: Sold in collaboration with Apeiron Synthesis, Inc. U.S. Patent 61/666,009, PCT/EP2013/062435. Apeiron Ruthenium Metathesis Catalyst Kit component. For detailed technical note visit strem.com.</p>		100mg 500mg
44-0040	<p>Bis(ethylcyclopentadienyl)ruthenium(II), 98% (99.9%-Ru) (32992-96-4) $[(CH_3CH_2)C_5H_4]_2Ru$; FW: 287.37; pale yellow liq.; d. 1.3412 Note: Available repackaged in ALD cylinder- see 98-4009, 98-4067.</p>	500mg 2g 10g	
98-4009	<p>Bis(ethylcyclopentadienyl)ruthenium(II), 98% (99.9%-Ru), 44-0040, contained in 50 ml Swagelok® cylinder (96-1070) for CVD/ALD (32992-96-4) $[(CH_3CH_2)C_5H_4]_2Ru$; FW: 287.37; pale yellow liq.; d. 1.3412 Note: High temperature Swagelok® cylinder assembly 96-1071 available at extra cost. See 98-4067.</p>	10g	
98-4067	<p>Bis(ethylcyclopentadienyl)ruthenium(II), 98% (99.9%-Ru), 44-0040, contained in high-temp 50 ml Swagelok® cylinder (96-1071) for CVD/ALD (32992-96-4) $[(CH_3CH_2)C_5H_4]_2Ru$; FW: 287.37; pale yellow liq.; d. 1.3412 Note: Liquid ruthenium CVD precursor.</p>	10g 20g	

RUTHENIUM (Compounds)

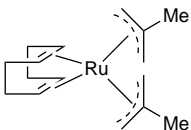
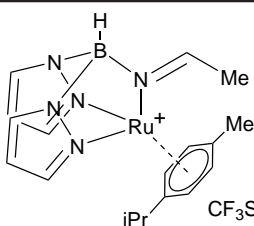
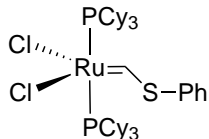
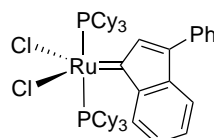
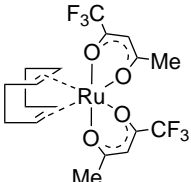
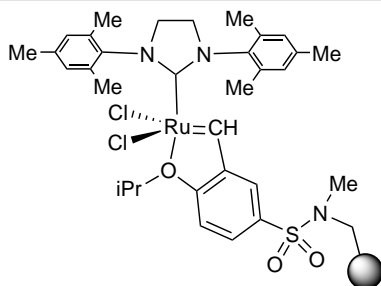
44-0046	Bis(2-methylallyl)(1,5-cyclooctadiene)ruthenium(II), min. 97% (12289-94-0) (C ₈ H ₇) ₂ (C ₈ H ₁₂)Ru; FW: 319.45; tan to brown powdr.; m.p. 80-85° (store cold) For detailed technical note visit strem.com .		250mg 1g 5g
44-0050	Bis(pentamethylcyclopentadienyl)ruthenium, 99% (99.9%-Ru) (Decamethylruthenocene) (84821-53-4) [(CH ₃) ₅ C ₅] ₂ Ru; FW: 371.53; off-white xtl.		500mg 2g
44-0355	[Bis(pyrazol-1-yl)(acetimino)hydridoborato (p-cymene)ruthenium(II) trifluoromethanesulfonate (1607436-49-6) C ₁₉ H ₂₅ BF ₃ N ₅ O ₃ RuS; FW: 572.38; yellow powdr. Note: Sold under license from USC for research purposes only. U.S. Patent No. 62/082,992. For detailed technical note visit strem.com .		100mg 500mg
44-0060	Bis(2,2,6,6-tetramethyl-3,5-heptanedionato)(1,5-cyclooctadiene)ruthenium(II), 99% (99.9%-Ru) (329735-79-7) (C ₁₁ H ₁₅ O ₂) ₂ (C ₈ H ₁₂)Ru; FW: 575.80; yellow-orange microxtl.; m.p. 187-190°; b.p. dec. 220° (subl. 100°/0.05mm)		1g 5g
Technical Note: 1. Ruthenium precursor for MOCVD. Air stable, readily sublimable organometallic complex.			
44-0073	Bis(tricyclohexylphosphine)[(phenylthio)methylene]ruthenium(II) dichloride, min. 97% (219770-99-7) RuCl ₂ (CHSC ₆ H ₅)[P(C ₆ H ₁₁) ₃] ₂ ; FW: 855.02; purple powdr. For detailed technical note visit strem.com .		1g 5g
44-0063	Bis(tricyclohexylphosphine)-3-phenyl-1H-inden-1-ylideneruthenium(II) dichloride (250220-36-1) RuCl ₂ (C ₁₅ H ₁₀)[P(C ₆ H ₁₁) ₃] ₂ ; FW: 923.07; brown powdr. Note: Sold in collaboration with Umicore for research purposes only. For detailed technical note visit strem.com .		1g 5g
44-8165	Bis(1,1,1-trifluoro-2,4-pentanedionato)(1,5-cyclooctadiene)ruthenium(II), 98% (38704-78-8) C ₁₈ H ₂₀ F ₆ O ₄ Ru; FW: 515.41; red-brown low melting solid; b.p. 120-160/1 mm		50mg 250mg
44-0083	1,3-Bis(2,4,6-trimethylphenyl)-4,5-dihydroimidazol-2-ylidene[2-(i-propoxy)-5-(N,N-dimethyl aminosulfonyl)phenyl]methyleneruthenium(II) dichloride (resin supported) Zhan Catalyst II FW: >1000; black solid; Loading: 0.5 mmol/g Note: Sold under license from Zannan for research purposes only. Patents CN1907992A, US 2007/0043180 A1, PCT WO 2007/003135 A1. For detailed technical note visit strem.com .		100mg 500mg 2g

RUTHENIUM (Compounds)

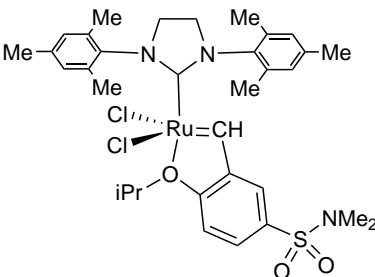
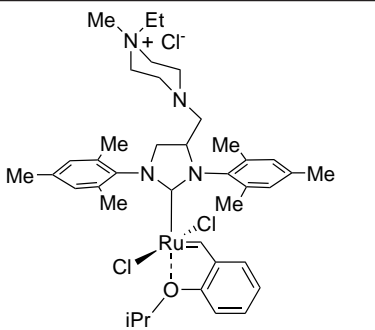
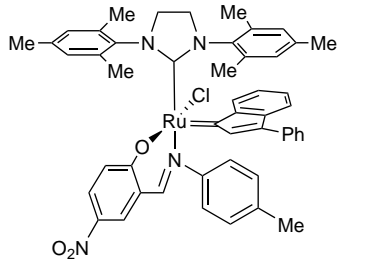
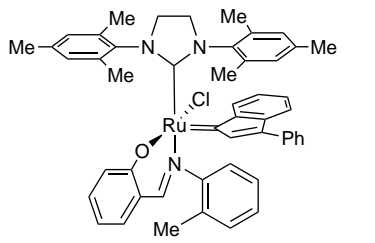
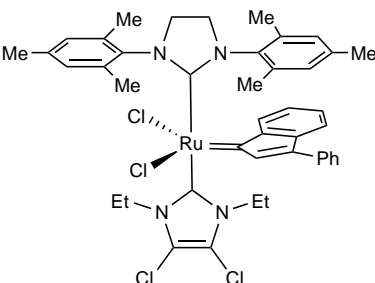
44-0082	<p>1,3-Bis(2,4,6-trimethylphenyl)-4,5-dihydroimidazol-2-ylidene[2-(i-propoxy)-5-(N,N-dimethylaminosulfonyl)phenyl]methyleneruthenium (II) dichloride, Zhan Catalyst-1B, min 96% (918870-76-5) $\text{RuCl}_2[\text{C}_{21}\text{H}_{26}\text{N}_2][\text{C}_{12}\text{H}_{17}\text{NO}_3\text{S}]$; FW: 733.75; green solid Note: Sold under license from Zannan for research purposes only. Patents CN1907992A, US 2007/0043180 A1, PCT WO 2007/003135 A1. For detailed technical note visit strem.com.</p>		100mg 500mg 2g
44-0768 NEW	<p>[1,3-Bis(2,4,6-trimethylphenyl)-4-[[4-ethyl-4-methylpiperazin-1-ium-1-yl]methyl]imidazolidin-2-ylidene)-(2-i-propoxybenzylidene)dichlororuthenium(II) chloride AquaMet (1414707-08-6) $\text{C}_{39}\text{H}_{55}\text{Cl}_3\text{N}_4\text{ORu}$; FW: 803.31; green powder. Note: Sold in collaboration with Apeiron Synthesis, Inc. U.S. Patent 61/603,790, PCT/EP2013/053967. Apeiron Ruthenium Metathesis Catalyst Kit component. For detailed technical note visit strem.com.</p>		100mg 500mg
44-0047	<p>[1,3-Bis(2,4,6-trimethylphenyl)-2-imidazolidinylidene]-[2-[[[4-methylphenyl]imino]methyl]-4-nitrophenolyl]-[3-phenyl-1H-inden-1-ylidene]ruthenium(II) chloride (934538-04-2) $\text{C}_{50}\text{H}_{47}\text{ClN}_4\text{O}_3\text{Ru}$; FW: 888.46; orange-brown solid Note: Sold in collaboration with Umicore for research purposes only. EP 1 468 004 B1, US 2002/0349956. For detailed technical note visit strem.com.</p>		100mg 500mg
44-0049	<p>[1,3-Bis(2,4,6-trimethylphenyl)-2-imidazolidinylidene]-[2-[[[2-methylphenyl]imino]methyl]phenolyl]-[3-phenyl-1H-inden-1-ylidene]ruthenium(II) chloride (934538-12-2) $\text{C}_{50}\text{H}_{48}\text{ClN}_4\text{ORu}$; FW: 843.46; red-brown solid Note: Sold in collaboration with Umicore for research purposes only. EP 1 468 004 B1, US 2002/0349956. For detailed technical note visit strem.com.</p>		100mg 500mg
44-0026	<p>1,3-Bis(2,4,6-trimethylphenyl)-2-imidazolidinylidene(3-phenyl-1H-inden-1-ylidene)(4,5-dichloro-1,3-diethyl-1,3-dihydro-2H-imidazol-2-ylidene)ruthenium(II) chloride (1228169-92-3) $\text{C}_{43}\text{H}_{46}\text{Cl}_4\text{N}_4\text{Ru}$; FW: 861.73; orange-brown solid Note: Sold in collaboration with Umicore for research purpose only. Patent US 10,873,026. For detailed technical note visit strem.com.</p>		50mg 250mg 1g

RUTHENIUM (Compounds)

44-0758 NEW	<p>[1,3-Bis(2,4,6-trimethylphenylimidazolidin-2-ylidene)]-(2-i-propoxy-5-nitrobenzylidene) ruthenium(II) dichloride nitro-Grela (502964-52-5) C₃₇H₃₇Cl₂N₃O₃Ru; FW: 671.62; green powdr. Note: Sold in collaboration with Apeiron Synthesis, Inc. U.S. Patent 6,867,303, PCT/EP2003/01122. Apeiron Ruthenium Metathesis Catalyst Kit component. For detailed technical note visit strem.com.</p>		100mg 500mg
44-0753 NEW	<p>[1,3-Bis(2,4,6-trimethylphenylimidazolidin-2-ylidene)](tricyclohexylphosphine)-(2-oxobenzylidene)ruthenium(II) chloride LatMet (1407229-58-6) C₄₆H₆₅ClN₃OPRu; FW: 829.52; green powdr. Note: Sold in collaboration with Apeiron Synthesis, Inc. U.S. Patent 9,328,132, PCT/EP2013/065839. Apeiron Ruthenium Metathesis Catalyst Kit component. For detailed technical note visit strem.com.</p>		100mg 500mg
44-0765 NEW	<p>[1,3-Bis(2,4,6-trimethylphenyl)-4-[(trimethylammonio)methyl]imidazolidin-2-ylidene)]-(2-i-propoxybenzylidene) dichlororuthenium(II) chloride StickyCat Cl (1452227-72-3) C₃₆H₄₈Cl₂N₃ORu; FW: 734.20; green powdr. Note: Sold in collaboration with Apeiron Synthesis, Inc. U.S. Patent 61/603,790, PCT/EP2013/053967. Apeiron Ruthenium Metathesis Catalyst Kit component. For detailed technical note visit strem.com.</p>		100mg 500mg
44-0090	<p>Carbonylbis(trifluoroacetato)bis(triphenylphosphine)ruthenium(II) methanol adduct, min. 98% (38596-61-1) RuCO[(C₆H₅)₃P]₂(CF₃COO)₂·XCH₃OH; FW: 879.71; orange xtl.; m.p. 230° dec. For detailed technical note visit strem.com.</p>		250mg 1g
44-1035 NEW	<p>Carbonylchlorohydrido[bis(2-di-t-butylphosphinoethyl)amine]ruthenium(II), min. 97% (1421060-10-7) C₂₇H₄₆ClN₂OP₂Ru; FW: 527.07; off-white solid <i>air sensitive</i></p>		250mg 1g
44-1043 NEW	<p>Carbonylchlorohydrido[bis(2-di-cyclohexylphosphinoethyl)amine]ruthenium(II), min. 97% (1421060-11-8) C₂₉H₅₄ClN₂OP₂Ru; FW: 631.22; white solid <i>air sensitive</i></p>		250mg 1g
44-0071	<p>Carbonylchlorohydrido[bis(2-(diphenylphosphinoethyl)amino)]ruthenium(II), min. 98% Ru-MACHO™ (1295649-40-9) C₂₇H₃₀ClN₂OP₂Ru; FW: 607.03; white to yellow powdr. <i>air sensitive</i> Note: Manufactured under license of Takasago patent. PCT/JP2010-004301. For detailed technical note visit strem.com.</p>		250mg 1g 5g
44-1032 NEW	<p>Carbonylchlorohydrido[bis(2-di-i-propylphosphinoethyl)amine]ruthenium(II), min. 97% (1311164-69-8) C₁₇H₃₈ClN₂OP₂Ru; FW: 470.96; off-white solid <i>air sensitive</i></p>		250mg 1g

RUTHENIUM (Compounds)

44-0081	Carbonylchlorohydrido[6-(di-t-butylphosphino-methyl)-2-(N,N-diethylaminomethyl)pyridine] ruthenium(II), min. 98% (Milstein Catalyst Precursor) (863971-62-4) $C_{26}H_{36}ClN_2OPRu$; FW: 488.01; pale yellow solid <i>air sensitive</i> Note: Air-stable in the solid state for several days, but best stored under an inert atmosphere. For detailed technical note visit strem.com .		100mg 500mg
44-0085	Carbonylchlorohydridotris(triphenylphosphine) ruthenium(II), 99% (16971-33-8) $Ru(CO)ClH[P(C_6H_5)_3]_3$; FW: 952.40; off-white to tan powd.; m.p. 209-210° For detailed technical note visit strem.com .		1g 5g
44-0100	Carbonyl(dihydrido)tris(triphenylphosphine) ruthenium (II), 99% (25360-32-1) $Ru(CO)(H)_2(P(C_6H_5)_3)_3$; FW: 917.97; white to off-white powd. For detailed technical note visit strem.com .		250mg 1g
44-0091	Carbonylhydrido[6-(di-t-butylphosphinomethylene)-2-(N,N-diethylaminomethyl)-1,6-dihydropyridine] ruthenium(II), min. 98% Milstein Catalyst (863971-63-5) $C_{26}H_{35}N_2OPRu$; FW: 451.55; red-black solid <i>air sensitive, (store cold)</i> For detailed technical note visit strem.com .		100mg 500mg
44-0074	Carbonylhydrido(tetrahydroborato)[bis(2-diphenylphosphinoethyl) amino]ruthenium(II), min.98% Ru-MACHO™-BH (1295649-41-0) $C_{29}H_{34}BNOP_2Ru$; FW: 586.41; white to yellow powd. <i>air sensitive</i> Note: Manufactured under license of Takasago patent PCT/JP2010-004301. For detailed technical note visit strem.com .		250mg 1g 5g
44-1030	Carbonyl[5,10,15,20-tetrakis(2,3,4,5,6-pentafluorophenyl)-21H,23H-porphinato]ruthenium(II), min. 98% (171899-61-9) $Ru(C_{44}H_8F_{20}N_4)CO$; FW: 1101.61; red xtl. For detailed technical note visit strem.com .		50mg 250mg

RUTHENIUM (Compounds)

44-1025	Carbonyl[5,10,15,20-tetrakis(2,4,6-trimethylphenyl)-21H,23H-porphinato]ruthenium(II), min. 98% (92669-43-7) Ru(C ₅₆ H ₅₂ N ₄)CO; FW: 910.12; red-orange xtl. For detailed technical note visit strem.com .	50mg 250mg	
96-5900	Chiral Quest Catalyst and Ligand Toolbox Kit for Asymmetric Hydrogenation See page 478		
44-0156	Chloro{[(1R,2R)-(-)-2-amino-1,2-diphenylethyl](pentafluorophenylsulfonyl)amido}(p-cymene)ruthenium(II), 90% RuCl[(R,R)-Fsdpen](p-cymene) (1026995-71-0) C ₃₀ H ₂₈ ClF ₅ N ₂ O ₂ RuS; FW: 712.14; orange to brown pwdr. <i>air sensitive</i> Note: Manufactured under license of Takasago patent US7129367B2. For detailed technical note visit strem.com .	250mg 1g 5g	
44-0157	Chloro{[(1S,2S)-(+)-2-amino-1,2-diphenylethyl](pentafluorophenylsulfonyl)amido}(p-cymene)ruthenium(II), min. 90% RuCl[(S,S)-Fsdpen](p-cymene) (1026995-72-1) C ₃₀ H ₂₈ ClF ₅ N ₂ O ₂ RuS; FW: 712.14; orange to brown pwdr. <i>air sensitive</i> Note: Manufactured under license of Takasago patent US7129367B2. Takasago ATH Catalyst Kit component. For detailed technical note visit strem.com .	250mg 1g 5g	
44-0149	Chloro{[(1S,2S)-(+)-2-amino-1,2-diphenylethyl](4-toluenesulfonyl)amido}(p-cymene)ruthenium(II), min. 90% RuCl[(S,S)-Tsdpen](p-cymene) (192139-90-5) C ₃₁ H ₃₅ ClN ₂ O ₂ RuS; FW: 636.21; yellow to dark brown solid <i>air sensitive</i> Note: Manufactured under license of Takasago patent US7129367B2. Takasago ATH Catalyst Kit component. For detailed technical note visit strem.com .	250mg 1g 5g	
44-0148	Chloro{[(1R,2R)-(-)-2-amino-1,2-diphenylethyl](4-toluenesulfonyl)amido}(p-cymene)ruthenium(II), min. 95% RuCl[(R,R)-Tsdpen](p-cymene) (192139-92-7) C ₃₁ H ₃₅ ClN ₂ O ₂ RuS; FW: 636.21; yellow to dark brown solid <i>air sensitive</i> Note: Manufactured under license of Takasago patent US7129367B2. Takasago ATH Catalyst Kit component. For detailed technical note visit strem.com .	250mg 1g 5g	

RUTHENIUM (Compounds)

44-0154	<p>Chloro{[(1R,2R)-(-)-2-amino-1,2-diphenylethyl] (4-toluenesulfonylamido)(mesitylene)ruthenium(II), min. 90% RuCl[(R,R)-Tsdpen(mesitylene)] (174813-82-2)} $C_{30}H_{33}ClN_2O_2RuS$; FW: 622.18; orange powdr. <i>air sensitive</i> Note: Manufactured under license of Takasago patent US7129367B2. Takasago ATH Catalyst Kit component. For detailed technical note visit strem.com.</p>		250mg 1g 5g
44-0155	<p>Chloro{[(1S,2S)-(+)-2-amino-1,2-diphenylethyl] (4-toluenesulfonylamido)(mesitylene)ruthenium(II), min. 90% RuCl[(S,S)-Tsdpen(mesitylene)] (174813-81-1)} $C_{30}H_{33}ClN_2O_2RuS$; FW: 622.18; yellow to dark brown solid <i>air sensitive</i> Note: Manufactured under license of Takasago patent US7129367B2. Takasago ATH Catalyst Kit component. For detailed technical note visit strem.com.</p>		250mg 1g 5g
44-0102	<p>Chloro{(R)-(-)-5,5'-bis[di(3,5-di-t-butyl-4-methoxyphenyl)phosphino]-4,4'-bi-1,3-benzodioxole}(p-cymene)ruthenium(II) chloride [RuCl(p-cymene)((R)-dtbm-segphos®)Cl] (944451-32-5)} $[C_{84}H_{114}ClO_8P_2Ru]^+Cl^-$; FW: 1485.72; orange to brown powdr.; m.p. >100° dec. <i>air sensitive</i> Note: Manufactured under license of Takasago patent. Takasago SEGPHOS® Ru Catalyst Kit component. For detailed technical note visit strem.com.</p>		250mg 1g 5g
44-0103	<p>Chloro{(S)-(+)-5,5'-bis[di(3,5-di-t-butyl-4-methoxyphenyl)phosphino]-4,4'-bi-1,3-benzodioxole}(p-cymene)ruthenium(II) chloride [RuCl(p-cymene)((S)-dtbm-segphos®)Cl] (944451-33-6)} $[C_{84}H_{114}ClO_8P_2Ru]^+Cl^-$; FW: 1485.72; orange to brown powdr.; m.p. >100° dec. <i>air sensitive</i> Note: Manufactured under license of Takasago patent. Takasago SEGPHOS® Ru Catalyst Kit component. For detailed technical note visit strem.com.</p>		250mg 1g 5g
44-0096	<p>Chloro{(R)-(+)-5,5'-bis(diphenylphosphino)-4,4'-bi-1,3-benzodioxole}(p-cymene)ruthenium(II) chloride [RuCl(p-cymene)((R)-segphos®)Cl] (944451-28-9)} $[C_{48}H_{42}ClO_4P_2Ru]^+Cl^-$; FW: 916.77; yellow powdr.; m.p. >100° dec. <i>air sensitive</i> Note: Manufactured under license of Takasago patent. Takasago SEGPHOS® Ru Catalyst Kit component. For detailed technical note visit strem.com.</p>		250mg 1g 5g

RUTHENIUM (Compounds)

44-0097	Chloro[(S)-(-)-5,5'-bis(diphenylphosphino)-4,4'-bi-1,3-benzodioxole](p-cymene) ruthenium(II) chloride [RuCl(p-cymene)((S)-segphos®)]Cl (944451-29-0) $[C_{38}H_{42}ClO_2P_2Ru] \cdot Cl$; FW: 916.77; ocher to dark brown powdr.; m.p. >100° dec. <i>air sensitive</i> Note: Manufactured under license of Takasago patent. Takasago SEGPHOS® Ru Catalyst Kit component. For detailed technical note visit strem.com .	250mg 1g 5g
44-0136	Chloro[(R)-(-)-2,2'-bis(diphenylphosphino)-1,1'-binaphthyl] [(R)-1,1-bis(4-methoxyphenyl)-3-methylbutane-1,2-diamine]ruthenium(II) tetrafluoroborate, min. 97% $C_{63}H_{58}BClF_4N_2O_2P_2Ru$; FW: 1160.42; orange powdr. Note: Sold under license from Kanata for research purposes only. PCT/CA2008/001905.	100mg 500mg
44-6063	Chloro[(S)-(-)-2,2'-bis[diphenylphosphino]-1,1'-binaphthyl][(S)-1,1-bis(4-methoxyphenyl)-3-methylbutane-1,2-diamine]ruthenium(II) tetrafluoroborate, min. 97% (1150112-86-9) $C_{63}H_{58}BClF_4N_2O_2P_2Ru$; FW: 1160.40; orange-red solid <i>air sensitive</i> Note: Sold under license from Kanata for research purposes only. WO 2009055912.	100mg 500mg
44-6066	Chloro[(S)-(-)-2,2'-bis[diphenylphosphino]-1,1'-binaphthyl] [(S)-1,1-bis(4-methoxyphenyl)-3-methylbutane-1,2-diamine]ruthenium(II) tetrakis(pentafluorophenyl)borate, min. 97% (1150112-87-0) $C_{87}H_{58}BClF_{20}N_2O_2P_2Ru$; FW: 1752.70; orange-red solid <i>air sensitive</i> Note: Sold under license from Kanata for research purposes only. WO 2009055912.	100mg 500mg
44-0134	Chloro[(R)-2,2'-bis(diphenylphosphino)-1,1'-binaphthyl][(1R,2R)-cyclohexane-1,2-diamine]ruthenium(II) tetrafluoroborate, min. 97% (1150112-42-7) $C_{50}H_{46}BClF_4N_2P_2Ru$; FW: 960.19; orange solid Note: Sold under license from Kanata for research purposes only. PCT/CA2008/001905.	100mg 500mg
44-6053	Chloro[(S)-2,2'-bis(diphenylphosphino)-1,1'-binaphthyl][(1S,2S)-cyclohexane-1,2-diamine]ruthenium(II) tetrafluoroborate, min. 97% $C_{50}H_{46}BClF_4N_2P_2Ru$; FW: 960.19; yellow solid <i>air sensitive</i> Note: Sold under license from Kanata for research purposes only. WO 2009055912.	100mg 500mg

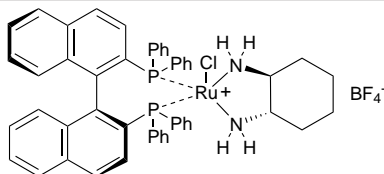
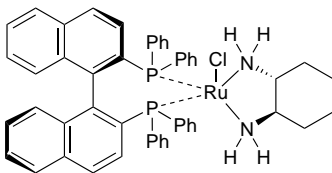
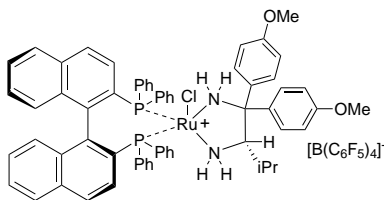
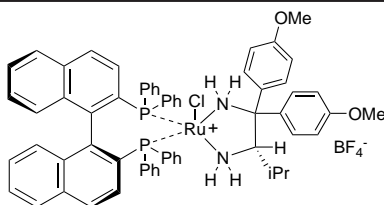
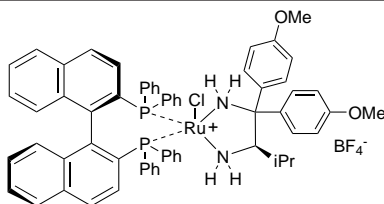

RUTHENIUM (Compounds)

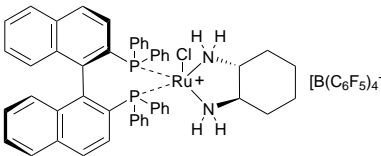
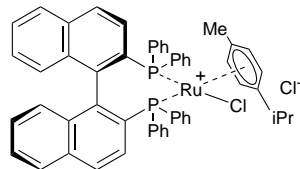
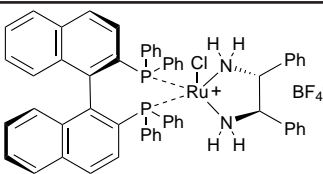
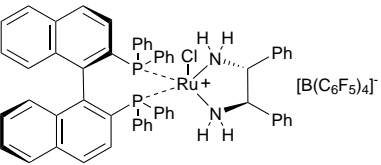
44-6054	<p>Chloro[(R)-2,2'-bis(diphenylphosphino)-1,1'-binaphthyl][(1R,2R)-cyclohexane-1,2-diamine]ruthenium(II) tetrakis(pentafluorophenyl)borate, min. 97% (1150112-55-2) $C_{74}H_{46}BClF_{20}N_2P_2Ru$; FW: 1552.42; yellow solid <i>air sensitive</i> Note: Sold under license from Kanata for research purposes only. WO 2009055912.</p>		100mg 500mg
44-6055	<p>Chloro[(S)-2,2'-bis(diphenylphosphino)-1,1'-binaphthyl][(1S,2S)-cyclohexane-1,2-diamine]ruthenium(II) tetrakis(pentafluorophenyl)borate, min. 97% $C_{74}H_{46}BClF_{20}N_2P_2Ru$; FW: 1552.42; yellow solid <i>air sensitive</i> Note: Sold under license from Kanata for research purposes only. WO 2009055912.</p>	100mg 500mg	
44-0084	<p>Chloro[(R)-(+)-2,2'-bis(diphenylphosphino)-1,1'-binaphthyl](p-cymene)ruthenium(II) chloride [RuCl(p-cymene)(R)-binap]Cl (145926-28-9) $[C_{54}H_{46}ClP_2Ru]Cl$; FW: 928.87; orange powder; m.p. >100° dec. <i>air sensitive</i> Note: Manufactured under license of Takasago patent. Takasago BINAP Ru Cymene Catalyst Kit component. For detailed technical note visit strem.com.</p>		250mg 1g 5g
44-0086	<p>Chloro[(S)-(-)-2,2'-bis(diphenylphosphino)-1,1'-binaphthyl](p-cymene)ruthenium(II) chloride [RuCl(p-cymene)((S)-binap)]Cl (130004-33-0) $[C_{54}H_{46}ClP_2Ru]Cl$; FW: 928.87; orange powder; m.p. >100° dec. <i>air sensitive</i> Note: Manufactured under license of Takasago patent. Takasago BINAP Ru Cymene Catalyst Kit component. For detailed technical note visit strem.com.</p>	250mg 1g 5g	
44-6057	<p>Chloro[(R)-2,2'-bis(diphenylphosphino)-1,1'-binaphthyl][(1R,2R)-2-(diphenylphosphino)-1,2-diphenylethanamine]ruthenium(II) tetrafluoroborate, min. 97% (1150112-54-1) $C_{70}H_{56}BClF_4NP_3Ru$; FW: 1227.45; orange to brown solid <i>air sensitive</i> Note: Sold under license from Kanata for research purposes only. WO 2009055912.</p>		100mg 500mg
44-6070	<p>Chloro[(R)-2,2'-bis(diphenylphosphino)-1,1'-binaphthyl][(1R,2R)-2-(diphenylphosphino)-1,2-diphenylethanamine]ruthenium(II) tetrakis(pentafluorophenyl)borate, min. 97% (1150112-53-0) $C_{94}H_{56}BClF_{20}NP_3Ru$; FW: 1819.68; orange to brown solid <i>air sensitive</i> Note: Sold under license from Kanata for research purposes only. WO 2009055912.</p>		100mg 500mg

RUTHENIUM (Compounds)

44-6056	<p>Chloro[(R)-2,2'-bis(diphenylphosphino)-1,1'-binaphthyl][2-(diphenylphosphino)ethanamine]ruthenium(II) tetrafluoroborate, min. 97% (1150112-44-9) $C_{58}H_{48}BClF_4NP_3Ru$; FW: 1075.26; yellow solid <i>air sensitive</i> Note: Sold under license from Kanata for research purposes only. WO 2009055912.</p>		100mg 500mg
44-0109	<p>Chloro[(R)-(-)-1,13-bis(diphenylphosphino)-7,8-dihydro-6H-dibenzo[f,h][1,5]dioxonin](p-cymene) ruthenium(II) chloride (R)-C₃-TUNEPHOS-Ru $[RuCl(C_{39}H_{32}O_2P_2)(C_{10}H_{14})] \cdot Cl$; FW: 900.81; orange to brown powdr. <i>air sensitive</i> Note: Sold in collaboration with Chiral Quest for research purposes only. Patent US 6,521,769. Chiral Quest Catalyst and Ligand Toolbox Kit component. For detailed technical note visit strem.com.</p>		100mg 500mg
44-6060	<p>Chlorobis[2-(diphenylphosphino)ethanamine]ruthenium(II) tetrafluoroborate, min. 97% (1150112-46-1) $C_{28}H_{32}BClF_4N_2P_2Ru$; FW: 681.84; yellow solid <i>air sensitive</i> Note: Sold under license from Kanata for research purposes only. WO 2009055912.</p>		100mg 500mg
44-0094	<p>Chloro[(R)-(+)-2,2'-bis(diphenylphosphino)-5,5',6,6',7,7',8,8'-octahydro-1,1'-binaphthyl](p-cymene) ruthenium(II) chloride [RuCl(p-cymene)((R)-H₈-binap)]Cl (944451-26-7) $[C_{54}H_{54}ClP_2Ru] \cdot Cl$; FW: 936.93; pale yellow powdr.; m.p. >100° dec. <i>air sensitive</i> Note: Manufactured under license of Takasago patent. For detailed technical note visit strem.com.</p>		50mg 250mg
44-0095	<p>Chloro[(S)-(-)-2,2'-bis(diphenylphosphino)-5,5',6,6',7,7',8,8'-octahydro-1,1'-binaphthyl](p-cymene)ruthenium(II) chloride [RuCl(p-cymene)((S)-H₈-binap)]Cl (944451-27-8) $[C_{54}H_{54}ClP_2Ru] \cdot Cl$; FW: 936.93; pale yellow powdr.; m.p. >100° dec. <i>air sensitive</i> Note: Manufactured under license of Takasago patent. For detailed technical note visit strem.com.</p>		50mg 250mg
44-6068	<p>Chlorobis[2-(di-i-propylphosphino)ethanamine] ruthenium(II) tetrafluoroborate, min. 97% $C_{16}H_{40}BClF_4N_2P_2Ru$; FW: 546.14; red-brown solid <i>air sensitive</i> Note: Sold under license from Kanata for research purposes only. WO 2009055912. For detailed technical note visit strem.com.</p>		100mg 500mg

RUTHENIUM (Compounds)

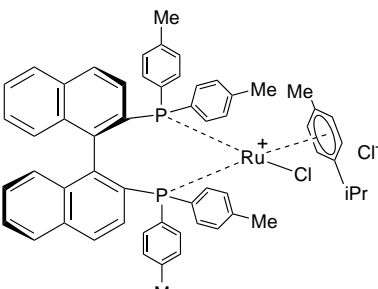
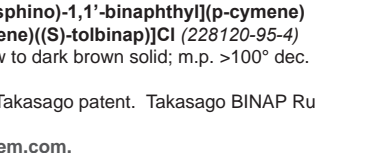
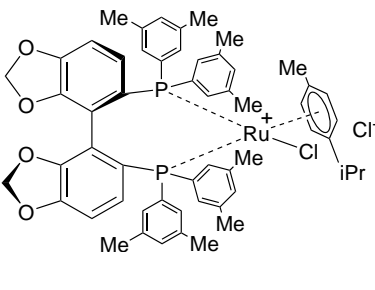
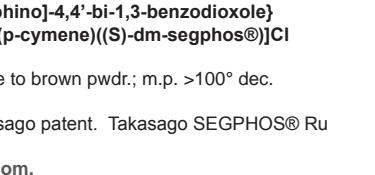
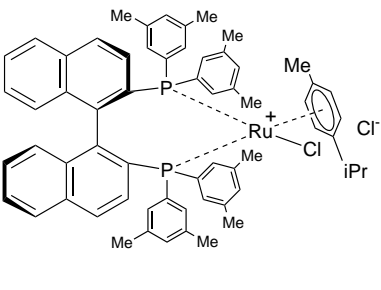
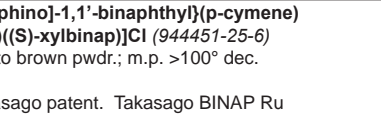
44-0088	<p>Chloro[(R)-(+)-2,2'-bis(di-p-tolylphosphino)-1,1'-binaphthyl](p-cymene)ruthenium(II) chloride [RuCl(p-cymene)((R)-tolbinap)]Cl (131614-43-2) $[C_{58}H_{54}ClP_2Ru]^+Cl^-$; FW: 984.97; brown powdr.; m.p. >100° dec. <i>air sensitive</i> Note: Manufactured under license of Takasago patent. Takasago BINAP Ru Cymene Catalyst Kit component. For detailed technical note visit strem.com.</p>		250mg 1g 5g
44-0089	<p>Chloro[(S)-(-)-2,2'-bis(di-p-tolylphosphino)-1,1'-binaphthyl](p-cymene)ruthenium(II) chloride [RuCl(p-cymene)((S)-tolbinap)]Cl (228120-95-4) $[C_{58}H_{54}ClP_2Ru]^+Cl^-$; FW: 984.97; yellow to dark brown solid; m.p. >100° dec. <i>air sensitive</i> Note: Manufactured under license of Takasago patent. Takasago BINAP Ru Cymene Catalyst Kit component. For detailed technical note visit strem.com.</p>		250mg 1g 5g
44-0098	<p>Chloro[(R)-(+)-5,5'-bis(di(3,5-xylyl)phosphino)-4,4'-bi-1,3-benzodioxole](p-cymene)ruthenium(II) chloride [RuCl(p-cymene)((R)-dm-segphos®)]Cl (944451-30-3) $[C_{66}H_{56}ClO_2P_2Ru]^+Cl^-$; FW: 1028.98; orange to brown powdr.; m.p. >100° dec. <i>air sensitive</i> Note: Manufactured under license of Takasago patent. Takasago SEGPHOS® Ru Catalyst Kit component. For detailed technical note visit strem.com.</p>		250mg 1g 5g
44-0099	<p>Chloro[(S)-(-)-5,5'-bis(di(3,5-xylyl)phosphino)-4,4'-bi-1,3-benzodioxole](p-cymene)ruthenium(II) chloride [RuCl(p-cymene)((S)-dm-segphos®)]Cl (944451-31-4) $[C_{66}H_{56}ClO_2P_2Ru]^+Cl^-$; FW: 1028.98; orange to brown powdr.; m.p. >100° dec. <i>air sensitive</i> Note: Manufactured under license of Takasago patent. Takasago SEGPHOS® Ru Catalyst Kit component. For detailed technical note visit strem.com.</p>		250mg 1g 5g
44-0092	<p>Chloro[(R)-(+)-2,2'-bis(di(3,5-xylyl)phosphino)-1,1'-binaphthyl](p-cymene)ruthenium(II) chloride [RuCl(p-cymene)((R)-xylbinap)]Cl (944451-24-5) $[C_{62}H_{62}ClP_2Ru]^+Cl^-$; FW: 1041.08; orange to brown powdr.; m.p. >100° dec. <i>air sensitive</i> Note: Manufactured under license of Takasago patent. Takasago BINAP Ru Cymene Catalyst Kit component. For detailed technical note visit strem.com.</p>		250mg 1g 5g
44-0093	<p>Chloro[(S)-(-)-2,2'-bis(di(3,5-xylyl)phosphino)-1,1'-binaphthyl](p-cymene)ruthenium(II) chloride [RuCl(p-cymene)((S)-xylbinap)]Cl (944451-25-6) $[C_{62}H_{62}ClP_2Ru]^+Cl^-$; FW: 1041.08; orange to brown powdr.; m.p. >100° dec. <i>air sensitive</i> Note: Manufactured under license of Takasago patent. Takasago BINAP Ru Cymene Catalyst Kit component.</p>		250mg 1g 5g

Technical Note:

1. See 44-0092 (page 375)

RUTHENIUM (Compounds)

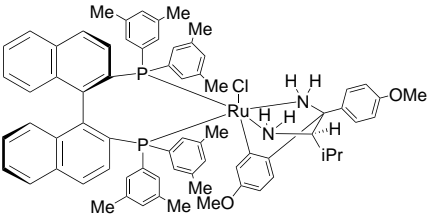
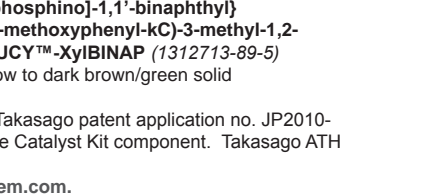
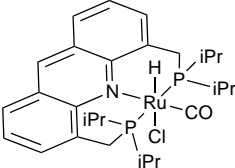
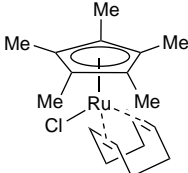
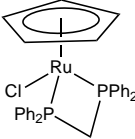
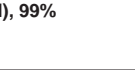
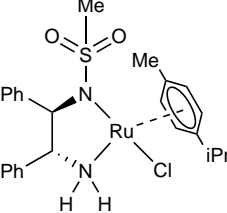
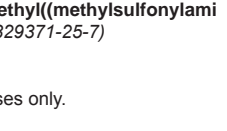
44-0217	<p>Chloro{(R)-(+)-2,2'-bis[di(3,5-xylyl)phosphino]-1,1'-binaphthyl} [(2R)-(-)-1-(4-methoxyphenyl)-1'-(4-methoxyphenyl-kC)-3-methyl-1,2-butanediamine] ruthenium(II) (R)-RUCY™-XylBINAP (1384974-38-2) $C_{77}H_{73}ClN_2O_2P_2Ru$; FW: 1184.82; yellow to dark brown/green solid <i>air sensitive</i></p>		100mg 250mg 1g 5g
44-0218	<p>Chloro{(S)-(-)-2,2'-bis[di(3,5-xylyl) phosphino]-1,1'-binaphthyl} [(2S)- (+)-1-(4-methoxyphenyl)-1'-(4-methoxyphenyl-kC)-3-methyl-1,2-butanediamine]ruthenium(II) (S)-RUCY™-XylBINAP (1312713-89-5) $C_{77}H_{73}ClN_2O_2P_2Ru$; FW: 1184.82; yellow to dark brown/green solid <i>air sensitive</i> Note: Manufactured under license of Takasago patent application no. JP2010-104552. Takasago BINAP Ru Diamine Catalyst Kit component. Takasago ATH Catalyst Kit component. For detailed technical note visit strem.com.</p>		250mg 1g 5g
44-0525	<p>Chlorocarbonylhydrido[4,5-bis-(di-i-propylphosphinomethyl) acridine] ruthenium(II), min.98% Milstein Acridine Catalyst (1101230-25-4) $C_{26}H_{40}ClN_2O_2P_2Ru$; FW: 605.09; orange solid <i>air sensitive</i> Note: Patents: US provisional 61/087,708, PCT/IL2009/000778. For detailed technical note visit strem.com.</p>		25mg 100mg
44-0113	<p>Chloro(1,5-cyclooctadiene) (pentamethylcyclopentadienyl)ruthenium(II), 98% (92390-26-6) $RuCl(C_8H_{12})(C_{10}H_{15})$; FW: 379.93; brown microxtls. <i>(store cold)</i> For detailed technical note visit strem.com.</p>		250mg 1g
44-0116	<p>Chloro(cyclopentadienyl)[bis(diphenylphosphino)methane] ruthenium(II), min. 97% (71397-33-6) $RuCl(C_5H_5)[(C_6H_5)_2PCH_2P(C_6H_5)_2]$; FW: 586.01; orange xtl. For detailed technical note visit strem.com.</p>		250mg 1g
44-0120	<p>Chloro(cyclopentadienyl)bis(triphenylphosphine)ruthenium(II), 99% (32993-05-8) $C_5H_5Ru[P(C_6H_5)_3]_2Cl$; FW: 726.20; orange xtl.; m.p. 130-133° dec.</p>		1g 5g
44-2319	<p>Chloro(p-cymene)[(1R,2R)-(-)-2-amino-1,2-diphenylethyl(methylsulfonylamido)]ruthenium(II) RuCl(p-cymene)[(R,R)-MsDpen] (1097730-63-6) $C_{26}H_{31}ClN_2O_2RuS$; FW: 560.10; yellow-orange solid <i>air sensitive</i> Note: Sold in collaboration with JM for research purposes only. For detailed technical note visit strem.com.</p>		250mg 1g
44-2320	<p>Chloro(p-cymene)[(1S,2S)-(-)-2-amino-1,2-diphenylethyl(methylsulfonylamido)]ruthenium(II) RuCl(p-cymene)[(S,S)-MsDpen] (329371-25-7) $C_{26}H_{31}ClN_2O_2RuS$; FW: 560.10; orange solid <i>air sensitive</i> Note: Sold in collaboration with JM for research purposes only. For detailed technical note visit strem.com.</p>		250mg 1g

RUTHENIUM (Compounds)

44-0123 Chlorodicarbonyl[1-(i-propylamino)-2,3,4,5-tetraphenylcyclopentadienyl]ruthenium(II), min. 95% (470688-18-7)
 $\text{RuCl}(\text{CO})_2(\text{C}_{32}\text{H}_{28}\text{N})$; FW: 619.11; yellow xtl.; m.p. 197° dec.
air sensitive

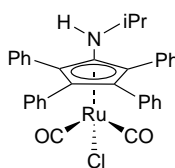

500mg
2g

Technical Note:

1. Metal catalyst used in conjunction with enzymes for enantioselective transformations via dynamic kinetic resolution.

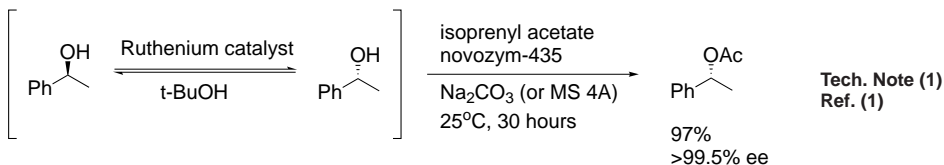

References:

1. *Current Opinion in Biotechnology*, **2002**, 13, 578
2. *Angew. Chem. Int. Ed.*, **2002**, 41, 2373
3. *J. Am. Chem. Soc.*, **2003**, 125, 11494

44-0128 Chloro(4,4'-dicarboxy-2,2'-bipyridine)(p-cymene)ruthenium(II) chloride, min. 98%
 $[\text{RuCl}(\text{C}_{10}\text{H}_8\text{N}_2\text{O}_4)(\text{C}_{10}\text{H}_{14})]\cdot\text{Cl}$; FW: 550.40;
 orange powdr.

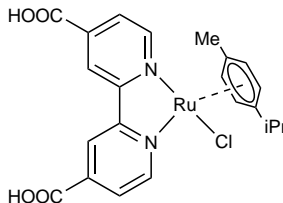

250mg
1g

Technical Note:

1. Product used as a dye to sensitize solar cells.

44-0121 Chloro[(R)-(+)-5,5'-dichloro-6,6'-dimethoxy-2,2'-bis(diphenylphosphino)-1,1'-biphenyl](p-cymene)ruthenium(II) chloride CH_2Cl_2 adduct (821793-33-3)
 $\text{RuCl}[(\text{C}_{38}\text{H}_{30}\text{Cl}_2\text{O}_2\text{P}_2)(\text{C}_{10}\text{H}_{14})]\cdot\text{Cl}\cdot\text{CH}_2\text{Cl}_2$;
 FW: 957.69 (1042.62); orange-brown powdr.
air sensitive

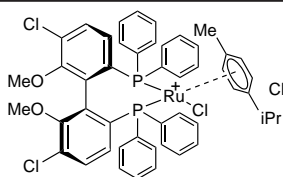

50mg
250mg

Note: Sold in collaboration with Lanxess for research purposes only. The product and its uses fall within the scope of US patents 5,710,339 and 5,801,261 and is sold with the right to use such product for research only.

For detailed technical note visit strem.com.

44-0122 Chloro[(S)-(-)-5,5'-dichloro-6,6'-dimethoxy-2,2'-bis(diphenylphosphino)-1,1'-biphenyl](p-cymene)ruthenium(II) chloride CH_2Cl_2 adduct (821793-35-5)
 $[\text{RuCl}(\text{C}_{38}\text{H}_{30}\text{Cl}_2\text{O}_2\text{P}_2)(\text{C}_{10}\text{H}_{14})]\cdot\text{Cl}\cdot\text{CH}_2\text{Cl}_2$;
 FW: 957.69 (1042.62); orange-brown powdr.
air sensitive

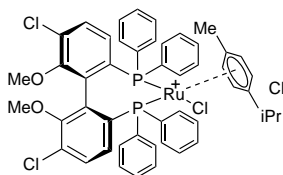

50mg
250mg

Note: Sold in collaboration with Lanxess for research purposes only. The product and its uses fall within the scope of US patents 5,710,339 and 5,801,261 and is sold with the right to use such product for research only.

For detailed technical note visit strem.com.

RUTHENIUM (Compounds)

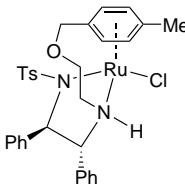
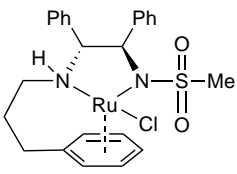
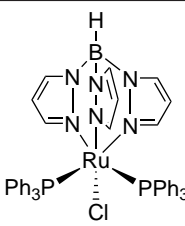
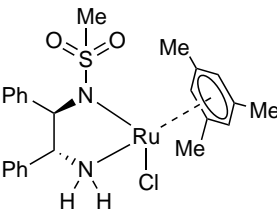
44-0185	<p>Chloro[N-[(1R,2R)-1,2-diphenyl-2-(2-(4-methylbenzyloxy)ethylamino)-ethyl]-4-methylbenzene sulfonamide(chloro)ruthenium(II) (R,R)-Ts-DENE^B™ (1333981-84-2) C₃₁H₃₃ClN₂O₃RuS; FW: 650.19; gray to brown solid <i>air sensitive</i> Note: Manufactured under license of Takasago patent application PCT/JP2011/064490. For detailed technical note visit strem.com.</p>		250mg 1g 5g
44-3020	<p>Chloro{[(1R,2R)-1,2-diphenyl-1-[(3-(η6-phenyl)propyl)amino]-2-(methylsulfonylamido)}ruthenium(II) RuCl[(R,R)-teth-MsDpen] (1361415-88-4) C₂₄H₂₇ClN₂O₂RuS; FW: 544.07; brown powdr. <i>air sensitive</i> Note: Sold in collaboration with JM for research purposes only. For detailed technical note visit strem.com.</p>		100mg 500mg
44-3021	<p>Chloro[(1S,2S)-1,2-diphenyl-1-[(3-(η6-phenyl)propyl)amino]-2-(methylsulfonylamido)}ruthenium(II) RuCl[(S,S)-teth-MsDpen] (1437326-26-5) C₂₄H₂₇ClN₂O₂RuS; FW: 544.07; brown powdr. <i>air sensitive</i> Note: Sold in collaboration with JM for research purposes only. For detailed technical note visit strem.com.</p>		100mg 500mg
93-4401	<p>Chlorohydridotris(triphenylphosphine)ruthenium(II) toluene adduct, 98% (55102-19-7) RuHCl[P(C₆H₅)₃]₃·CH₃C₆H₅; FW: 924.39 (1016.53); purple xtl. <i>air sensitive</i> For detailed technical note visit strem.com.</p>		250mg 1g
44-0124	<p>Chloro[hydrotris(pyrazol-1-yl)borato]bis(triphenylphosphine)ruthenium(II) ethanol adduct (141686-21-7) RuCl[(C₆H₅)₃P]₂(C₆H₁₀BN₂)·0.5CH₃CH₂OH; FW: 874.12 (897.16); yellow powdr. For detailed technical note visit strem.com.</p>		250mg 1g
44-0125	<p>Chloro(indenyl)bis(triphenylphosphine)ruthenium(II), dichloromethane adduct, min. 98% (99897-61-7) RuCl[(C₆H₇)][P(C₆H₅)₃]₂·CH₂Cl₂; FW: 776.26 (861.16); red-brown xtl.</p>		1g 5g
44-2325	<p>Chloro(mesitylene)[(1R,2R)-(-)-2-amino-1,2-diphenylethyl(methylsulfonylamido)}ruthenium(II) RuCl(mesitylene)[(R,R)-MsDpen] (1160707-20-9) C₂₄H₂₉ClN₂O₂RuS; FW: 546.10; brown powdr. <i>air sensitive</i> Note: Sold in collaboration with JM for research purposes only. For detailed technical note visit strem.com.</p>		250mg 1g
44-2326	<p>Chloro(mesitylene)[(1S,2S)-(+)-2-amino-1,2-diphenylethyl(methylsulfonylamido)}ruthenium(II) RuCl(mesitylene)[(S,S)-MsDpen] (865488-44-4) C₂₄H₂₉ClN₂O₂RuS; FW: 546.10; brown powdr. <i>air sensitive</i> Note: Sold in collaboration with JM for research purposes only. For detailed technical note visit strem.com.</p>		250mg 1g

RUTHENIUM (Compounds)

44-0255	<p>Chloro{N-[(1R,2R)-2-[(S)-[2-[[1,2,3,4,5,6-η]-4-methylphenyl]methoxy]ethyl]amino]-1,2-diphenylethylmethanesulfonamidato}ruthenium(II) Ru-(R,R)-Ms-DENEb (1333981-86-4) C₂₅H₂₉ClN₂O₃RuS; FW: 574.10; light to dark brown powdr. Note: Manufactured under license of Takasago patent application PCT/JP2011/064490. Takasago ATH Catalyst Kit component. For detailed technical note visit strem.com.</p>		250mg 1g 5g
44-0256	<p>Chloro{N-[(1S,2S)-2-[(R)-[2-[[1,2,3,4,5,6-η]-4-methylphenyl]methoxy]ethyl]amino]-1,2-diphenylethylmethanesulfonamidato}ruthenium(II) Ru-(S,S)-Ms-DENEb (1361318-83-3) C₂₅H₂₉ClN₂O₃RuS; FW: 574.10; light to dark brown powdr. Note: Manufactured under license of Takasago patent application PCT/JP2011/064490. Takasago ATH Catalyst Kit component. For detailed technical note visit strem.com.</p>		250mg 1g 5g
44-0130	<p>Chloropentaammineruthenium(III) chloride, 98% (18532-87-1) [Ru(NH₃)₅Cl]Cl₂; FW: 292.58; yellow xtl.</p>		1g 5g
44-0117	<p>Chloro(pentamethylcyclopentadienyl)bis(triphenylphosphine)ruthenium(II), 99% (92361-49-4) RuCl(C₁₀H₁₅)[P(C₆H₅)₃]₂; FW: 796.32; orange powdr. (store cold) For detailed technical note visit strem.com.</p>		250mg 1g
44-0145	<p>Chloro(pentamethylcyclopentadienyl)ruthenium(II) tetramer, min. 95% (113860-07-4) [C₁₀H₁₅RuCl]₄; FW: 1087.01; dark red xtl. <i>air sensitive</i></p>		100mg 500mg 2g
44-0138	<p>Chloro(1-phenylindenyl)bis(triphenylphosphine)ruthenium(II), min. 98% (1360949-97-8) C₅₁H₄₁ClP₂Ru; FW: 852.34; red-brown solid For detailed technical note visit strem.com.</p>		250mg 1g
44-0160	<p>Cyclopentadienyl(p-cymene)ruthenium(II) hexafluorophosphate, min. 98% (147831-75-2) [Ru(C₅H₅)(C₁₀H₁₄)⁺PF₆⁻]; FW: 445.35; off-white to pale brown powdr.; m.p. 82-84°</p>		250mg 1g
44-0180	<p>Diacetato{(R)-(-)-5,5'-bis[di(3,5-di-t-butyl-4-methoxyphenyl)phosphino]-4,4'-bi-1,3-benzodioxole}ruthenium(II) Ru(OAc)₂[(R)-dtbm-segphos@] (1025477-38-6) C₇₈H₁₀₆O₁₂P₂Ru; FW: 1398.69; yellow to brownish-red to dark green solid <i>air sensitive</i> Note: Manufactured under license of Takasago patent. Takasago SEGPHOS® Ru Catalyst Kit component. For detailed technical note visit strem.com.</p>		250mg 1g 5g

RUTHENIUM (Compounds)

44-0181	Diacetato[(S)-(+)-5,5'-bis[di(3,5-di-t-butyl-4-methoxyphenyl)phosphino]-4,4'-bi-1,3-benzodioxole]ruthenium(II) Ru(OAc)₂[(S)-dtbm-segphos®] (1025476-84-9) C ₇₈ H ₁₀₈ O ₁₂ P ₂ Ru; FW: 1398.69; yellow to brownish-red to dark green solid <i>air sensitive</i> Note: Manufactured under license of Takasago patent. Takasago SEGPHOS® Ru Catalyst Kit component. For detailed technical note visit strem.com .	250mg 1g 5g
44-0168	Diacetato[(R)-(+)-5,5'-bis(diphenylphosphino)-4,4'-bi-1,3-benzodioxole]ruthenium(II) Ru(OAc)₂[(R)-segphos®] (944450-48-0) C ₄₂ H ₃₄ O ₈ P ₂ Ru; FW: 829.73; dark yellow powdr.; m.p. >100° dec. <i>air sensitive</i> Note: Manufactured under license of Takasago patent. Takasago SEGPHOS® Ru Catalyst Kit component. For detailed technical note visit strem.com .	250mg 1g 5g
44-0169	Diacetato[(S)-(-)-5,5'-bis(diphenylphosphino)-4,4'-bi-1,3-benzodioxole]ruthenium(II) Ru(OAc)₂[(S)-segphos®] (373650-12-5) C ₄₂ H ₃₄ O ₈ P ₂ Ru; FW: 829.73; yellow to black solid; m.p. >100° dec. <i>air sensitive</i> Note: Manufactured under license of Takasago patent. Takasago SEGPHOS® Ru Catalyst Kit component. For detailed technical note visit strem.com .	250mg 1g 5g
44-0152	Diacetato[(R)-(+)-2,2'-bis(diphenylphosphino)-1,1'-binaphthyl]ruthenium(II) Ru(OAc)₂[(R)-binap] (325146-81-4) C ₄₈ H ₃₈ O ₄ P ₂ Ru; FW: 841.83; pale yellow powdr.; m.p. >100° dec. <i>air sensitive</i> Note: Manufactured under license of Takasago patent. Takasago BINAP Ru Acetate Catalyst Kit component. For detailed technical note visit strem.com .	250mg 1g 5g
44-0153	Diacetato[(S)-(-)-2,2'-bis(diphenylphosphino)-1,1'-binaphthyl]ruthenium(II) Ru(OAc)₂[(S)-binap] (261948-85-0) C ₄₈ H ₃₈ O ₄ P ₂ Ru; FW: 841.83; pale yellow powdr.; m.p. >100° dec. <i>air sensitive</i> Note: Manufactured under license of Takasago patent. Takasago BINAP Ru Acetate Catalyst Kit component.	250mg 1g 5g
Technical Note: 1. See 44-0152 (page 380)		
44-0166	Diacetato[(R)-(+)-2,2'-bis(diphenylphosphino)-5,5',6,6',7,7',8,8'-octahydro-1,1'-binaphthyl]ruthenium(II) Ru(OAc)₂[(R)-H₈-binap] (374067-51-3) C ₄₈ H ₄₆ O ₄ P ₂ Ru; FW: 849.89; ocher to olive solid; m.p. >100° dec. <i>air sensitive</i> Note: Manufactured under license of Takasago patent. For detailed technical note visit strem.com .	50mg 250mg
44-0167	Diacetato[(S)-(-)-2,2'-bis(diphenylphosphino)-5,5',6,6',7,7',8,8'-octahydro-1,1'-binaphthyl]ruthenium(II) Ru(OAc)₂[(S)-H₈-binap] (142962-95-6) C ₄₈ H ₄₆ O ₄ P ₂ Ru; FW: 849.89; yellow to dark brown solid; m.p. >100° dec. <i>air sensitive</i> Note: Manufactured under license of Takasago patent. For detailed technical note visit strem.com .	50mg 250mg

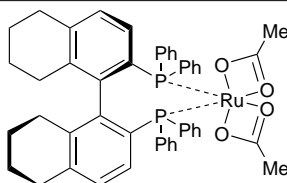
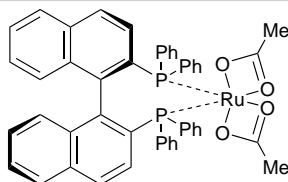
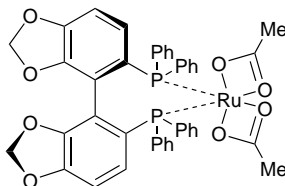

RUTHENIUM (Compounds)

44-0162	<p>Diacetato[(R)-(+)-2,2'-bis(di-p-tolylphosphino)-1,1'-binaphthyl]ruthenium(II) Ru(OAc)₂[(R)-tolbinap] (116128-29-1) C₅₇H₄₆O₄P₂Ru; FW: 897.94; brown powdr.; m.p. >100° dec. <i>air sensitive</i> Note: Manufactured under license of Takasago patent. Takasago BINAP Ru Acetate Catalyst Kit component. For detailed technical note visit strem.com.</p>		250mg 1g 5g
44-0163	<p>Diacetato[(S)-(-)-2,2'-bis(di-p-tolylphosphino)-1,1'-binaphthyl]ruthenium(II) Ru(OAc)₂[(S)-tolbinap] (106681-15-6) C₅₇H₄₆O₄P₂Ru; FW: 897.94; brown powdr.; m.p. >100° dec. <i>air sensitive</i> Note: Manufactured under license of Takasago patent. Takasago BINAP Ru Acetate Catalyst Kit component.</p>		250mg 1g 5g
Technical Note:			
1. See 44-0162 (page 381)			
44-0174	<p>Diacetato[(R)-(+)-5,5'-bis[di(3,5-xylyl)phosphino]-4,4'-bi-1,3-benzodioxole]ruthenium(II) Ru(OAc)₂[(R)-dm-segphos®] (944450-49-1) C₅₀H₅₀O₈P₂Ru; FW: 941.95; yellow to brownish-red to dark green solid; m.p. >100° dec. <i>air sensitive</i> Note: Manufactured under license of Takasago patent. Takasago SEGPHOS® Ru Catalyst Kit component. For detailed technical note visit strem.com.</p>		250mg 1g 5g
44-0176	<p>Diacetato[(S)-(-)-5,5'-bis[di(3,5-xylyl)phosphino]-4,4'-bi-1,3-benzodioxole]ruthenium(II) Ru(OAc)₂[(S)-dm-segphos®] (944450-50-4) C₅₀H₅₀O₈P₂Ru; FW: 941.95; yellow to brownish-red to dark green solid; m.p. >100° dec. <i>air sensitive</i> Note: Manufactured under license of Takasago patent. Takasago SEGPHOS® Ru Catalyst Kit component. For detailed technical note visit strem.com.</p>		250mg 1g 5g
44-0164	<p>Diacetato[(R)-(+)-2,2'-bis[di(3,5-xylyl)phosphino]-1,1'-binaphthyl]ruthenium(II) Ru(OAc)₂[(R)-xylbinap] (374067-50-2) C₅₆H₅₄O₄P₂Ru; FW: 954.04; dark brown powdr.; m.p. >100° dec. <i>air sensitive</i> Note: Manufactured under license of Takasago patent. Takasago BINAP Ru Acetate Catalyst Kit component. For detailed technical note visit strem.com.</p>		250mg 1g 5g
44-0165	<p>Diacetato[(S)-(-)-2,2'-bis[di(3,5-xylyl)phosphino]-1,1'-binaphthyl]ruthenium(II) Ru(OAc)₂[(S)-xylbinap] (374067-49-9) C₅₆H₅₄O₄P₂Ru; FW: 954.04; dark brown powdr.; m.p. >100° dec. <i>air sensitive</i> Note: Manufactured under license of Takasago patent. Takasago BINAP Ru Acetate Catalyst Kit component.</p>		250mg 1g 5g
Technical Note:			
1. See 44-0164 (page 381)			
44-0175	<p>Dicarbonylcyclopentadienylruthenium dimer, 99% (12132-87-5) [C₅H₅Ru(CO)₂]₂; FW: 444.36; orangish-brown xtl.</p>	100mg 500mg 2g	

RUTHENIUM (Compounds)

44-0170	Dichloro(benzene)ruthenium(II) dimer, 98% (37366-09-9) [C ₆ H ₆ RuCl ₂] ₂ ; FW: 500.18; orange powder.	250mg 1g
44-0232	Dichloro{(R)-2,2'-bis[bis(4-methylphenyl)]-1,1'-binaphthyl}[(1R,2R)-2-amino-1-phenylpropyldiphenylphosphine]ruthenium(II), min. 97% (1150113-55-5) C ₆₉ H ₆₂ Cl ₂ NP ₂ Ru; FW: 1170.13; orange solid <i>air sensitive</i> Note: Sold under license from Kanata for research purposes only. US Patents 7,579,295 and 7,317,131. For detailed technical note visit strem.com .	100mg 500mg
44-0260	Dichlorobis[2-(di-t-butylphosphino)ethylamine]ruthenium(II), min. 97% (1092372-91-2) RuCl ₂ (C ₁₀ H ₂₄ NP) ₂ ; FW: 550.53; orange powder. Note: Sold under license from Kanata for research purposes only. Patent WO0222526, EP1366004, US2004063966. For detailed technical note visit strem.com .	250mg 1g
44-6050	Dichlorobis[3-(di-t-butylphosphino)propylamine]ruthenium(II), min. 97% (1196147-60-0) C ₂₂ H ₅₂ Cl ₂ N ₂ P ₂ Ru; FW: 578.58; brown solid <i>air sensitive</i> Note: Sold under license from Kanata for research purposes only. US 7317131 and US 7579295.	250mg 1g
44-6015	Dichloro{1,2-bis[(2R,5R)-2,5-dimethylphospholanobenzene]}[2-(diphenylphosphino)ethylamine]ruthenium(II), min. 97% C ₃₂ H ₄₄ Cl ₂ NP ₃ Ru; FW: 707.60; yellow solid <i>air sensitive</i> Note: Sold under license from Kanata for research purposes only.	100mg 500mg
44-6018	Dichloro{(1R,2R)-N,N-bis[2-(diphenylphosphino)benzyl]cyclohexane-1,2-diamine}ruthenium(II), min. 97% (429678-11-5) C ₄₄ H ₄₄ Cl ₂ N ₂ P ₂ Ru; FW: 834.76; orange solid <i>air sensitive</i>	100mg 500mg
44-6019	Dichloro{(1S,2S)-N,N-bis[2-(diphenylphosphino)benzyl]cyclohexane-1,2-diamine}ruthenium(II), min. 97% (302924-37-4) C ₄₄ H ₄₄ Cl ₂ N ₂ P ₂ Ru; FW: 834.76; orange solid <i>air sensitive</i>	100mg 500mg
44-0263	Dichlorobis[2-(diphenylphosphino)ethylamine]ruthenium(II), min. 95% (mixture of isomers) (506417-41-0) RuCl ₂ (C ₁₄ H ₃₂ NP) ₂ ; FW: 630.49; yellow powder. Note: Sold under license from Kanata for research purposes only. Patent WO0222526, EP1366004, US2004063966. For detailed technical note visit strem.com .	250mg 1g

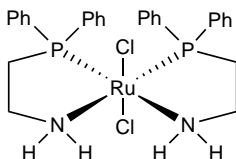
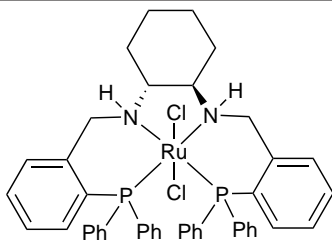
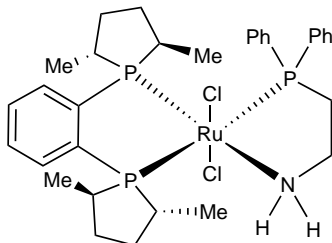
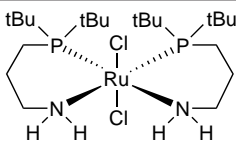
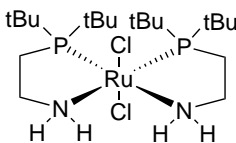
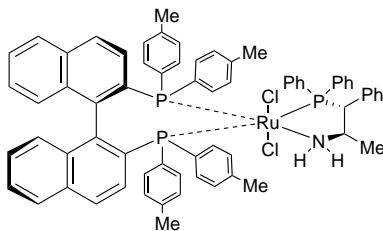

RUTHENIUM (Compounds)

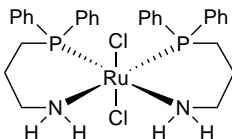
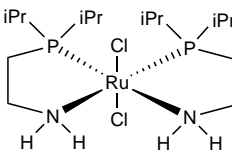
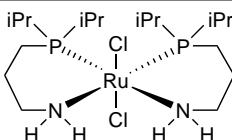
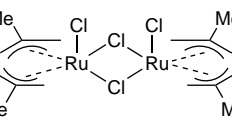
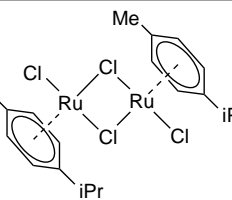
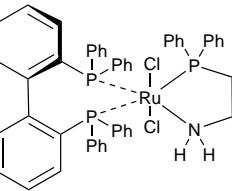
44-6040	Dichlorobis[3-(diphenylphosphino)propylamine] ruthenium(II), min. 97% (1196467-26-1) $C_{30}H_{36}Cl_2N_2P_2Ru$; FW: 658.54; yellow-brown solid <i>air sensitive</i> Note: Sold under license from Kanata for research purposes only. US 7317131 and US 7579295.		250mg 1g
44-0265	Dichlorobis[2-(di-i-propylphosphino)ethylamine] ruthenium(II), min. 97% (1092372-90-1) $RuCl_2(C_8H_{20}NP)_2$; FW: 494.43; orange powdr. Note: Sold under license from Kanata for research purposes only. Patent WO0222526, EP1366004, US2004063966. For detailed technical note visit strem.com .		250mg 1g
44-6043	Dichlorobis[3-(di-i-propylphosphino)propylamine] ruthenium(II), min. 97% (1196147-57-5) $C_{18}H_{44}Cl_2N_2P_2Ru$; FW: 522.48; yellow-orange solid <i>air sensitive</i> Note: Sold under license from Kanata for research purposes only. US 7317131 and US 7579295.		250mg 1g
44-0200	cis-Dichlorobis(2,2'-bipyridine)ruthenium(II) dihydrate, 99% (15746-57-3) $RuCl_2(C_{10}H_8N_2)_2 \cdot 2H_2O$; FW: 484.35 (520.38); black xtl.		1g 5g
44-0203	Dichlorobis(μ-chloro) bis[(1,2,3,6,7,8-#8776;)-2,7-dimethyl-2,6-octadien-1,8-diy]diruthenium(IV), 99% (34801-97-3) $Ru_2Cl_4(C_{10}H_{16})_2$; FW: 616.42; purple powdr.; m.p. 196° (dec.) <i>moisture sensitive</i> For detailed technical note visit strem.com .		250mg 1g
44-0190	Di-μ-chlorobis[(p-cymene)chlororuthenium(II)], min. 98% (52462-29-0) $[RuCl_2(C_{10}H_{14})_2]_2$; FW: 612.39; brown powdr.		1g 5g 25g
44-6025	Dichloro[(R)-bis(diphenylphosphino)-1,1-binaphthyl][2-(diphenylphosphino)ethylamine]ruthenium(II), min. 97% (1097731-98-0) $C_{58}H_{48}Cl_2NP_3Ru$; FW: 1023.91; yellow solid <i>air sensitive</i> Note: Sold under license from Kanata for research purposes only. US 7317131 and US 7579295.		100mg 500mg
44-6026	Dichloro[(S)-bis(diphenylphosphino)-1,1-binaphthyl][2-(diphenylphosphino)ethylamine]ruthenium(II), min. 97% $C_{58}H_{48}Cl_2NP_3Ru$; FW: 1023.91; yellow solid <i>air sensitive</i> Note: Sold under license from Kanata for research purposes only. US 7317131 and US 7579295.		100mg 500mg

RUTHENIUM (Compounds)

44-6022	<p>Dichloro[(R)-bis(diphenylphosphino)-1,1'-binaphthyl][(1R,2R)-2-amino-1-phenylpropyldiphenylphosphine] ruthenium(II), min. 97% $C_{65}H_{54}Cl_2NP_3Ru$; FW: 1114.03; yellow solid <i>air sensitive</i> Note: Sold under license from Kanata for research purposes only. US 7317131 and US 7579295.</p>		100mg 500mg
44-6023	<p>Dichloro[(R)-bis(diphenylphosphino)-1,1'-binaphthyl][(1S,2S)-2-amino-1-phenylpropyldiphenylphosphine] ruthenium(II), min. 97% $C_{65}H_{54}Cl_2NP_3Ru$; FW: 1114.03; yellow solid <i>air sensitive</i> Note: Sold under license from Kanata for research purposes only. US 7317131 and US 7579295.</p>		100mg 500mg
44-0210	<p>Dichloro[(R)-(+)-2,2'-bis(diphenylphosphino)-1,1'-binaphthyl][(2R)-(-)-1,1-bis(4-methoxyphenyl)-3-methyl-1,2-butanediamine]ruthenium(II) dichloromethane adduct, min. 97% (329735-86-6) $C_{63}H_{58}Cl_2N_2O_2P_2Ru$; FW: 1109.10; white to pale yellow powdr.; m.p. >100° dec. <i>air sensitive, (store cold)</i> For detailed technical note visit strem.com.</p>		10mg 50mg 250mg
44-0211	<p>Dichloro[(S)-(-)-2,2'-bis(diphenylphosphino)-1,1'-binaphthyl][(2S)-(+)-1,1-bis(4-methoxyphenyl)-3-methyl-1,2-butanediamine]ruthenium(II) dichloromethane adduct, min. 97% (212143-24-3) $C_{63}H_{58}Cl_2N_2O_2P_2Ru$; FW: 1109.10; white to pale yellow powdr.; m.p. >100° dec. <i>air sensitive, (store cold)</i> For detailed technical note visit strem.com.</p>		10mg 50mg 250mg
44-0925	<p>Dichloro[(S)-(-)-2,2'-bis(diphenylphosphino)-1,1'-binaphthyl][(S)-(-)-2-(α-(t-butyl) methanamine)-1H-benzimidazole] ruthenium(II), min. 95% $C_{56}H_{49}Cl_2N_3P_2Ru$; FW: 997.93; yellow-brown powdr. <i>air sensitive</i> Note: Sold under license from Enantitech for research purposes only. PCT/CN2008/073648, CN 200810038929. Enantitech BIMAH Ru BINAP Catalyst Kit component. For detailed technical note visit strem.com.</p>		100mg 500mg
44-0220	<p>Dichloro[(R)-(+)-2,2'-bis(diphenylphosphino)-1,1'-binaphthyl][(1R,2R)-(+)-1,2-diphenylethylenediamine] ruthenium(II), min. 90% (212143-23-2) $C_{56}H_{48}Cl_2N_2P_2Ru$; FW: 1006.96; white to pale yellow powdr.; m.p. >100° dec. <i>air sensitive, (store cold)</i> For detailed technical note visit strem.com.</p>		10mg 50mg 250mg

RUTHENIUM (Compounds)

44-0221	<p>Dichloro[(R)-(+)-2,2'-bis(diphenylphosphino)-1,1'-binaphthyl] [(1S,2S)-(-)-1,2-diphenylethylenediamine]ruthenium(II), min. 90% (212210-87-2) $C_{58}H_{48}Cl_2N_2P_2Ru$; FW: 1006.96; white to pale yellow powdr.; m.p. >100° dec. <i>air sensitive, (store cold)</i> For detailed technical note visit strem.com.</p>		10mg 50mg 250mg
44-0222	<p>Dichloro[(S)-(-)-2,2'-bis(diphenylphosphino)-1,1'-binaphthyl] [(1R,2R)-(+)-1,2-diphenylethylenediamine]ruthenium(II), min. 98% (329735-87-7) $C_{58}H_{48}Cl_2N_2P_2Ru$; FW: 1006.96; white to pale yellow powdr.; m.p. >100° dec. <i>air sensitive, (store cold)</i></p>		10mg 50mg 250mg
Technical Note:			
1. See 44-0221 (page 385)			
44-0223	<p>Dichloro[(S)-(-)-2,2'-bis(diphenylphosphino)-1,1'-binaphthyl] [(1S,2S)-(-)-1,2-diphenylethylenediamine]ruthenium(II), min. 98% (329736-05-2) $C_{58}H_{48}Cl_2N_2P_2Ru$; FW: 1006.96; white to pale yellow powdr.; m.p. >100° dec. <i>air sensitive, (store cold)</i> For detailed technical note visit strem.com.</p>		10mg 50mg 250mg
44-0910	<p>Dichloro[(R)-(+)-2,2'-bis(diphenylphosphino)-1,1'-binaphthyl] [(S)-(+)-2-(α-methylmethanamine)-1H-benzimidazole]ruthenium(II), min. 95% $C_{53}H_{43}Cl_2N_3P_2Ru$; FW: 955.85; yellow-brown powdr. <i>air sensitive</i> Note: Sold under license from Enantio- tech for research purposes only. PCT/CN2008/073648, CN 200810038929. Enantio- tech BIMA Ru BINAP Catalyst Kit component. For detailed technical note visit strem.com.</p>		100mg 500mg
44-0905	<p>Dichloro[(S)-(-)-2,2'-bis(diphenylphosphino)-1,1'-binaphthyl] [(S)-(-)-2-(α-methylmethanamine)-1H-benzimidazole]ruthenium(II), min. 95% (1443051-87-3) $C_{53}H_{43}Cl_2N_3P_2Ru$; FW: 955.85; yellow-brown powdr. <i>air sensitive</i> Note: Sold under license from Enantio- tech for research purposes only. PCT/CN2008/073648, CN 200810038929. Enantio- tech BIMA Ru BINAP Catalyst Kit component.</p>		100mg 500mg
Technical Note:			
1. See 44-0910 (page 385)			
44-0920	<p>Dichloro[(R)-(+)-2,2'-bis(diphenylphosphino)-1,1'-binaphthyl] [(R)-(+)-2-(i-propyl) methanamine]-1H-benzimidazole]ruthenium(II), min. 95% $C_{55}H_{47}Cl_2N_3P_2Ru$; FW: 983.90; yellow-brown powdr. <i>air sensitive</i> Note: Sold under license from Enantio- tech for research purposes only. PCT/CN2008/073648, CN 200810038929. Enantio- tech BIMA Ru BINAP Catalyst Kit component. For detailed technical note visit strem.com.</p>		100mg 500mg

RUTHENIUM (Compounds)

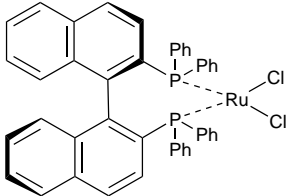
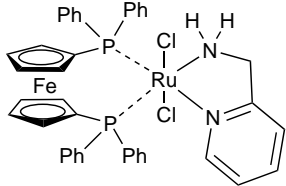
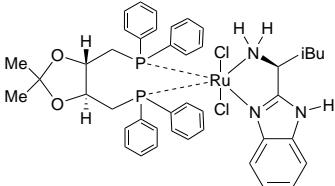
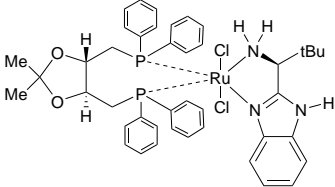
44-0915	Dichloro[(S)-(-)-2,2'-bis(diphenylphosphino)-1,1'-binaphthyl][(S)-(-)-2-(α-(i-propyl)methanamine)-1H-benzimidazole]ruthenium(II), min. 95% $C_{55}H_{47}Cl_2N_3P_2Ru$; FW: 983.90; yellow-brown powdr. <i>air sensitive</i> Note: Sold under license from EnantioTech for research purposes only. PCT/CN2008/073648, CN 200810038929. EnantioTech BIMAH Ru BINAP Catalyst Kit component.	100mg 500mg
Technical Note:		
1. See 44-0920 (page 385)		
44-0248	Dichloro[(R)-(+)-2,2'-bis(diphenylphosphino)-1,1'-binaphthyl]ruthenium(II), min. 95% (132071-87-5) $[RuCl_2(C_{44}H_{32}P_2)]$; FW: 794.67; orange powdr. <i>air sensitive</i> For detailed technical note visit strem.com .	100mg 500mg 2g
		
44-0249	Dichloro[(S)-(-)-2,2'-bis(diphenylphosphino)-1,1'-binaphthyl]ruthenium(II), min. 95% (134524-84-8) $[RuCl_2(C_{44}H_{32}P_2)]$; FW: 794.67; orange powdr. <i>air sensitive</i> For detailed technical note visit strem.com .	100mg 500mg 2g
44-2310	Dichloro[1,1'-bis(diphenylphosphino)ferrocene](2-aminomethylpyridine)ruthenium(II) $RuCl_2(AMPY)(DPPF)$ (1287255-62-2) $C_{40}H_{36}Cl_2FeN_2P_2Ru$; FW: 834.49; yellow powdr. <i>air sensitive</i> Note: Sold in collaboration with JM for research purposes only. For detailed technical note visit strem.com .	250mg 1g
		
44-0975	Dichloro[(4S,5S)-(+)-4,5-bis(diphenylphosphinomethyl)-2,2-dimethyl-1,3-dioxolane][(S)-(-)-2-(i-butyl)methanamine]-1H-benzimidazole]ruthenium(II), min. 95% (1574321-76-8) $C_{43}H_{48}Cl_2N_3O_2P_2Ru$; FW: 873.79; yellow-brown powdr. <i>air sensitive</i> Note: Sold under license from EnantioTech for research purposes only. PCT/CN2008/073648, CN 200810038929. EnantioTech BIMAH Ru DIOP Catalyst Kit component. For detailed technical note visit strem.com .	100mg 500mg
		
44-0980	Dichloro[(4S,5S)-(+)-4,5-bis(diphenylphosphinomethyl)-2,2-dimethyl-1,3-dioxolane][(S)-(-)-2-(t-butyl)methanamine]-1H-benzimidazole]ruthenium(II), min. 97% (1443051-98-6) $C_{43}H_{48}Cl_2N_3O_2P_2Ru$; FW: 873.79; yellow-brown powdr. <i>air sensitive</i> Note: Sold under license from EnantioTech for research purposes only. PCT/CN2008/073648, CN 200810038929. EnantioTech BIMAH Ru DIOP Catalyst Kit component. For detailed technical note visit strem.com .	100mg 500mg
		

RUTHENIUM (Compounds)

44-0960	<p>Dichloro[(4R,5R)-(-)-4,5-bis(diphenylphosphinomethyl)-2,2-dimethyl-1,3-dioxolane][(R)-(+)-2-(α-methylmethanamine)-1H-benzimidazole]ruthenium(II), min. 95% (1280732-29-7) $C_{40}H_{43}Cl_2N_3O_2P_2Ru$; FW: 831.71; yellow-brown powdr. <i>air sensitive</i> Note: Sold under license from Enantio- tech for research purposes only. PCT/CN2008/073648, CN 200810038929. Enantio- tech BIMA Ru DIOP Catalyst Kit component. For detailed technical note visit strem.com.</p>	100mg 500mg	
44-0955	<p>Dichloro[(4S,5S)-(+)-4,5-bis(diphenylphosphinomethyl)-2,2-dimethyl-1,3-dioxolane][(S)-(-)-2-(α-methylmethanamine)-1H-benzimidazole]ruthenium(II), min. 98% (1280730-21-3) $C_{40}H_{43}Cl_2N_3O_2P_2Ru$; FW: 831.71; yellow-brown powdr. <i>air sensitive</i> Note: Sold under license from Enantio- tech for research purposes only. PCT/CN2008/073648, CN 200810038929. Enantio- tech BIMA Ru DIOP Catalyst Kit component.</p>	100mg 500mg	
Technical Note: 1. See 44-0960 (page 387)			
44-0970	<p>Dichloro[(4R,5R)-(-)-4,5-bis(diphenylphosphinomethyl)-2,2-dimethyl-1,3-dioxolane][(R)-(+)-2-(i-propylmethanamine)-1H-benzimidazole]ruthenium(II), min. 95% (1443051-97-5) $C_{42}H_{47}Cl_2N_3O_2P_2Ru$; FW: 859.76; yellow-brown powdr. <i>air sensitive</i> Note: Sold under license from Enantio- tech for research purposes only. PCT/CN2008/073648, CN 200810038929. Enantio- tech BIMA Ru DIOP Catalyst Kit component. For detailed technical note visit strem.com.</p>	100mg 500mg	
44-0965	<p>Dichloro[(4S,5S)-(+)-4,5-bis(diphenylphosphinomethyl)-2,2-dimethyl-1,3-dioxolane][(S)-(-)-2-(i-propylmethanamine)-1H-benzimidazole]ruthenium(II), min. 95% (1443051-97-5) $C_{42}H_{47}Cl_2N_3O_2P_2Ru$; FW: 859.76; yellow-brown powdr. <i>air sensitive</i> Note: Sold under license from Enantio- tech for research purposes only. PCT/CN2008/073648, CN 200810038929. Enantio- tech BIMA Ru DIOP Catalyst Kit component.</p>	100mg 500mg	
Technical Note: 1. See 44-0970 (page 387)			
44-2314	<p>Dichloro[(R)-(+)-2,2'-bis(di-p-tolylphosphino)-1,1'-binaphthyl](2-aminomethylpyridine)ruthenium(II) RuCl₂(AMPY) [(R)Tol-Binap] (858116-31-1) $C_{54}H_{48}Cl_2N_2P_2Ru$; FW: 958.89; yellow powdr. <i>air sensitive</i> Note: Sold in collaboration with JM for research purposes only. For detailed technical note visit strem.com.</p>	250mg 1g	

RUTHENIUM (Compounds)

44-2315	<p>Dichloro[(S)-(-)-2,2'-bis(di-p-tolylphosphino)-1,1'-binaphthyl](2-aminomethylpyridine)ruthenium(II) RuCl₂(AMPY)[(S)-Tol-Binap] (857678-55-8) C₅₄H₄₈Cl₂N₃P₂Ru; FW: 958.89; yellow pwdr. <i>air sensitive</i> Note: Sold in collaboration with JM for research purposes only. For detailed technical note visit strem.com.</p>	250mg 1g
44-0950	<p>Dichloro[(S)-(-)-2,2'-bis(di-p-tolylphosphino)-1,1'-binaphthyl] [(S)-(-)-2-(α-(t-butyl) methanamine)-1H-benzimidazole]ruthenium(II), min. 97% C₆₀H₅₇Cl₂N₃P₂Ru; FW: 1054.04; yellow-brown pwdr. <i>air sensitive</i> Note: Sold under license from Enantitech for research purposes only. PCT/CN2008/073648, CN 200810038929. Enantitech BIMAH Ru Tol-BINAP Catalyst Kit component. For detailed technical note visit strem.com.</p>	100mg 500mg
44-0935	<p>Dichloro[(R)-(+)-2,2'-bis(di-p-tolylphosphino)-1,1'-binaphthyl] [(R)-(+)-2-(α-methylmethanamine)-1H-benzimidazole]ruthenium(II), min. 95% C₅₇H₅₁Cl₂N₃P₂Ru; FW: 1011.96; yellow-brown pwdr. <i>air sensitive</i> Note: Sold under license from Enantitech for research purposes only. PCT/CN2008/073648, CN 200810038929. Enantitech BIMAH Ru Tol-BINAP Catalyst Kit component. For detailed technical note visit strem.com.</p>	100mg 500mg
44-0930	<p>Dichloro[(S)-(-)-2,2'-bis(di-p-tolylphosphino)-1,1'-binaphthyl] [(S)-(-)-2-(α-methylmethanamine)-1H-benzimidazole]ruthenium(II), min. 97% C₅₇H₅₁Cl₂N₃P₂Ru; FW: 1011.96; yellow-brown pwdr. <i>air sensitive</i> Note: Sold under license from Enantitech for research purposes only. PCT/CN2008/073648, CN 200810038929. Enantitech BIMAH Ru Tol-BINAP Catalyst Kit component.</p>	100mg 500mg
Technical Note:		
1. See 44-0935 (page 388)		
44-0945	<p>Dichloro[(R)-(+)-2,2'-bis(di-p-tolylphosphino)-1,1'-binaphthyl] [(R)-(+)-2-(α-(i-propyl) methanamine)-1H-benzimidazole] ruthenium(II), min. 95% C₅₉H₅₅Cl₂N₃P₂Ru; FW: 1040.01; yellow-brown pwdr. <i>air sensitive</i> Note: Sold under license from Enantitech for research purposes only. PCT/CN2008/073648, CN 200810038929. Enantitech BIMAH Ru Tol-BINAP Catalyst Kit component. For detailed technical note visit strem.com.</p>	100mg 500mg

RUTHENIUM (Compounds)

44-0940	Dichloro[(S)-(-)-2,2'-bis(di-p-tolylphosphino)-1,1'-binaphthyl][(S)-(-)-2-(α-(i-propyl) methanamine)-1H-benzimidazole]ruthenium(II), min. 95% $C_{55}H_{55}Cl_2N_3P_2Ru$; FW: 1040.01; yellow-brown pwdr. <i>air sensitive</i> Note: Sold under license from EnantioTech for research purposes only. PCT/CN2008/073648, CN 200810038929. EnantioTech BIMAH Ru Tol-BINAP Catalyst Kit component.	100mg 500mg
Technical Note: 1. See 44-0945 (page 388)		
44-0214	Dichloro{(R)-(+)-5,5'-bis[di(3,5-xylyl)phosphino]-4,4'-bi-1,3-benzodioxole} [(2R)-(-)-1,1-bis(4-methoxyphenyl)-3-methyl-1,2-butanediamine]ruthenium(II) RuCl₂[(R)-dm-segphos@][(R)-daipen] (944450-43-5) $C_{65}H_{70}Cl_2N_2O_6P_2Ru$; FW: 1209.18; yellow pwdr. <i>air sensitive</i> Note: Manufactured under license of Takasago patent. Takasago SEGPHOS® Ru Catalyst Kit component. For detailed technical note visit strem.com .	250mg 1g 5g
<p>The structure shows a ruthenium (Ru) center coordinated to two chlorine (Cl) atoms and two phosphorus (P) atoms of the dm-segphos ligand. The dm-segphos ligand consists of two 3,5-dimethyl-2,2'-biphenylphosphino groups linked by a 1,3-benzodioxole bridge. The (R)-daipen ligand is a 1,2-diphenyl-3-methylbutane-1,2-diamine derivative with a 4-methoxyphenyl group on the chiral carbon.</p>		
44-0215	Dichloro{(S)-(-)-5,5'-bis[di(3,5-xylyl)phosphino]-4,4'-bi-1,3-benzodioxole} [(2S)-(+)-1,1-bis(4-methoxyphenyl)-3-methyl-1,2-butanediamine]ruthenium(II) RuCl₂[(S)-dm-segphos@][(S)-daipen] (944450-44-6) $C_{65}H_{70}Cl_2N_2O_6P_2Ru$; FW: 1209.18; yellow pwdr. <i>air sensitive</i> Note: Manufactured under license of Takasago patent. Takasago SEGPHOS® Ru Catalyst Kit component.	250mg 1g 5g
Technical Note: 1. See 44-0214 (page 389)		
44-0228	Dichloro{(R)-(+)-5,5'-bis[di(3,5-xylyl)phosphino]-4,4'-bi-1,3-benzodioxole}[(1R,2R)-(+)-1,2-diphenylethylenediamine]ruthenium(II) RuCl₂[(R)-dm-segphos@][(R,R)-dpem] (944450-45-7) $C_{60}H_{60}Cl_2N_2O_4P_2Ru$; FW: 1075.04; yellow pwdr. <i>air sensitive</i> Note: Manufactured under license of Takasago patent. Takasago SEGPHOS® Ru Catalyst Kit component. For detailed technical note visit strem.com .	250mg 1g 5g
<p>The structure shows a ruthenium (Ru) center coordinated to two chlorine (Cl) atoms and two phosphorus (P) atoms of the dm-segphos ligand. The dm-segphos ligand is identical to the one in entry 44-0214. The (R,R)-dpem ligand is a 1,2-diphenylethylenediamine derivative.</p>		
44-0229	Dichloro{(S)-(-)-5,5'-bis[di(3,5-xylyl)phosphino]-4,4'-bi-1,3-benzodioxole} [(1S,2S)-(-)-1,2-diphenylethylenediamine]ruthenium(II) RuCl₂[(S)-dm-segphos@][(S,S)-dpem] (944450-46-8) $C_{60}H_{60}Cl_2N_2O_4P_2Ru$; FW: 1075.04; yellow pwdr. <i>air sensitive</i> Note: Manufactured under license of Takasago patent. Takasago SEGPHOS® Ru Catalyst Kit component.	250mg 1g 5g
Technical Note: 1. See 44-0228 (page 389)		

RUTHENIUM (Compounds)

44-0212	<p>Dichloro{(R)-(-)-2,2'-bis[di(3,5-xylyl)phosphino]-1,1'-binaphthyl}[(2R)-(-)-1,1-bis(4-methoxyphenyl)-3-methyl-1,2-butanediamine]ruthenium(II) RuCl₂[(R)-xylbinap][(R)-daipen] (220114-32-9)</p> <p>C₇₁H₇₄Cl₂N₂O₂P₂Ru; FW: 1221.28; yellow to dark brown or green solid <i>air sensitive</i></p> <p>Note: Manufactured under license of Takasago patent. Takasago BINAP Ru Diamine Catalyst Kit component. For detailed technical note visit strem.com.</p>	250mg 1g 5g
<p>The structure shows a central ruthenium atom coordinated to two chlorine atoms and two phosphorus atoms of a binaphthyl-based ligand. The phosphorus atoms are further substituted with two 3,5-dimethylphenyl groups each. The ruthenium is also coordinated to two nitrogen atoms of a chiral diamine ligand, which has a 3-methyl-1,2-butanediol backbone and two 4-methoxyphenyl groups.</p>		
44-0213	<p>Dichloro{(S)-(-)-2,2'-bis[di(3,5-xylyl)phosphino]-1,1'-binaphthyl}[(2S)-(+)-1,1-bis(4-methoxyphenyl)-3-methyl-1,2-butanediamine]ruthenium(II) RuCl₂[(S)-xylbinap][(S)-daipen] (220114-01-2)</p> <p>C₇₁H₇₄Cl₂N₂O₂P₂Ru; FW: 1221.28; orange powder. <i>air sensitive</i></p> <p>Note: Manufactured under license of Takasago patent. Takasago BINAP Ru Diamine Catalyst Kit component.</p>	250mg 1g 5g
Technical Note:		
1. See 44-0212 (page 390)		
44-0226	<p>Dichloro{(R)-(+)-2,2'-bis[di(3,5-xylyl)phosphino]-1,1'-binaphthyl}[(1R,2R)-(+)-1,2-diphenylethylenediamine]ruthenium(II) RuCl₂[(R)-xylbinap][(R,R)-dpen] (220114-38-5)</p> <p>C₆₆H₆₄Cl₂N₂P₂Ru; FW: 1119.15; yellow powder. <i>air sensitive</i></p> <p>Note: Manufactured under license of Takasago patent. Takasago BINAP Ru Diamine Catalyst Kit component. For detailed technical note visit strem.com.</p>	250mg 1g 5g
<p>The structure shows a central ruthenium atom coordinated to two chlorine atoms and two phosphorus atoms of a binaphthyl-based ligand. The phosphorus atoms are further substituted with two 3,5-dimethylphenyl groups each. The ruthenium is also coordinated to two nitrogen atoms of a chiral diamine ligand, which has a 1,2-diphenylethylene backbone.</p>		
44-0224	<p>Dichloro{(S)-(-)-2,2'-bis[di(3,5-xylyl)phosphino]-1,1'-binaphthyl}[(1S,2S)-(-)-1,2-diphenylethylenediamine]ruthenium(II) RuCl₂[(S)-xylbinap][(S,S)-dpen] (220114-03-4)</p> <p>C₆₆H₆₄Cl₂N₂P₂Ru; FW: 1119.15; yellow powder. <i>air sensitive</i></p> <p>Note: Manufactured under license of Takasago patent. Takasago BINAP Ru Diamine Catalyst Kit component.</p>	250mg 1g 5g
Technical Note:		
1. See 44-0226 (page 390)		

RUTHENIUM (Compounds)

44-0380	<p>Dichloro[(R)-(-)-4,12-bis(di(3,5-xylyl)phosphino)-[2.2]-paracyclophane] [(1S,2S)-(-)-1,2-diphenylethylenediamine]ruthenium(II), min. 95% (325150-57-0) $\text{RuCl}_2[\text{C}_{48}\text{H}_{50}\text{P}_2][\text{C}_{14}\text{H}_{16}\text{N}_2]$; FW: 1073.12; cream colored powdr. <i>air sensitive</i> Note: *Limited quantities available* Sold in collaboration with Chirotech for research purposes only. US Patent nos. 5874629 and 6486337. For detailed technical note visit strem.com.</p>		10mg 50mg
44-0381	<p>Dichloro[(S)-(+)-4,12-bis(di(3,5-xylyl)phosphino)-[2.2]-paracyclophane] [(1R,2R)-(+)-1,2-diphenylethylenediamine]ruthenium(II), min. 95% (364795-64-2) $\text{RuCl}_2[\text{C}_{48}\text{H}_{50}\text{P}_2][\text{C}_{14}\text{H}_{16}\text{N}_2]$; FW: 1073.12; cream colored powdr. <i>air sensitive</i> Note: ** Limited quantities available ** Sold in collaboration with Chirotech for research purposes only. US Patent nos. 5874629 and 6486337. For detailed technical note visit strem.com.</p>		10mg 50mg
44-0445	<p>Dichlorobis(μ-methanethioato) bis(pentamethylcyclopentadienyl) diruthenium(III), 99% (minimum 90% syn isomer) (216064-20-9) $\text{C}_{22}\text{H}_{36}\text{Cl}_2\text{Ru}_2\text{S}_2$; FW: 637.70; black xtl. For detailed technical note visit strem.com.</p>		100mg 500mg 2g
44-0425	<p>Dichloro(1,5-cyclooctadiene)ruthenium(II) polymer, min. 97% (50982-12-2) $[\text{Ru}(\text{1,5-C}_8\text{H}_{12}\text{Cl}_2)]_n$; FW: 280.16; brown powdr.; m.p. 200° dec.</p>		250mg 1g 5g
44-0430	<p>Dichloro(p-cymene)tricyclohexylphosphineruthenium(II), min. 97% (145381-23-3) $\text{RuCl}_2(\text{C}_{10}\text{H}_{14})\text{P}(\text{C}_6\text{H}_{11})_3$; FW: 586.62; orange powdr. For detailed technical note visit strem.com.</p>		250mg 1g
44-0433	<p>Dichloro(p-cymene)triphenylphosphineruthenium(II) dichloromethane adduct, min. 98% (52490-94-5) $\text{C}_{28}\text{H}_{29}\text{Cl}_2\text{PRu}\cdot\text{CH}_2\text{Cl}_2$; FW: 568.48 (653.41); orange to red powdr. For detailed technical note visit strem.com.</p>		250mg 1g 5g
44-0400	<p>Dichlorodicarbonylbis(triphenylphosphine)ruthenium(II), min. 98% (14564-35-3) $\text{RuCl}_2(\text{CO})_2(\text{P}(\text{C}_6\text{H}_5)_3)_2$; FW: 752.56; white powdr.</p>		250mg 1g
44-0760	<p>Dichloro(1,3-dimesitylimidazolidin-2-ylidene){2-[(ethoxy-2-oxoethylidene)amino]benzylidene} ruthenium(II) HeatMet $\text{C}_{32}\text{H}_{37}\text{Cl}_2\text{N}_3\text{O}_2\text{Ru}$; FW: 667.63; dark purple xtls. (store cold) Note: Sold in collaboration with Apeiron Synthesis, Inc. U.S. Patent 14/443,034; PCT/IN2013/002543. For detailed technical note visit strem.com.</p>		100mg 500mg

RUTHENIUM (Compounds)

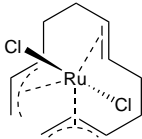
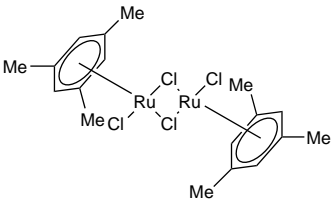
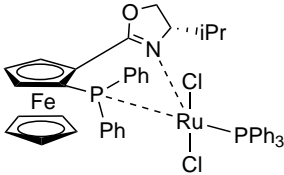
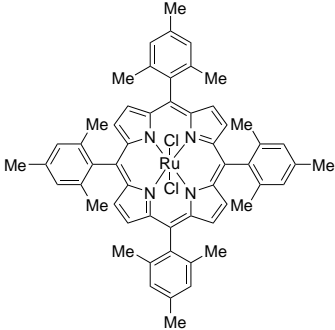
44-0172	Dichloro(2,6,10-dodecatriene-1,12-diyl)ruthenium(IV), 99% (12170-97-7) RuCl ₂ (C ₁₂ H ₁₈); FW: 334.24; orange xtl.; m.p. 192° (dec.) For detailed technical note visit strem.com .		250mg 1g
44-0428	Dichloro(mesitylene)ruthenium(II) dimer, 98% (52462-31-4) NEW C ₁₈ H ₂₄ Cl ₂ Ru ₂ ; FW: 584.33; red powdr. <i>air sensitive, (store cold)</i>		500mg 2g
44-0440	Dichloro(pentamethylcyclopentadienyl)ruthenium(III) polymer (96503-27-4) [C ₅ (CH ₃) ₅ RuCl ₂] _n ; FW: (307.20) _n ; red to brown powdr. <i>air sensitive, (store cold)</i>		250mg 1g 5g
44-0442	(+)-Dichloro[(4R)-4-(i-propyl)-2-((R)-2-(diphenylphosphino)ferrocenyl)oxazoline](triphenylphosphine)ruthenium(II) (1312582-16-3) RuCl ₂ [(C ₆ H ₅) ₃ P](C ₂₈ H ₂₈ FeNOP); FW: 915.70; orange-brown powdr. Note: Sold in collaboration with Solvias for research purposes only. For detailed technical note visit strem.com .		100mg 500mg 2g 10g
44-0443	(-)-Dichloro[(4S)-4-(i-propyl)-2-((S)-2-(diphenylphosphino)ferrocenyl)oxazoline](triphenylphosphine)ruthenium(II) (212133-11-4) RuCl ₂ [(C ₆ H ₅) ₃ P](C ₂₈ H ₂₈ FeNOP); FW: 915.70; orange-brown powdr. Note: Sold in collaboration with Solvias for research purposes only. For detailed technical note visit strem.com .		100mg 500mg 2g 10g
44-1020	Dichloro[5,10,15,20-tetrakis(2,4,6-trimethylphenyl)-21H,23H-porphinato]ruthenium(IV), min. 98% (145698-90-4) Ru(C ₅₆ H ₅₂ N ₄)Cl ₂ ; FW: 953.01; purple xtl. For detailed technical note visit strem.com .		25mg 100mg

RUTHENIUM (Compounds)

44-0385	<p>Dichloro[(R)(+)-2,2',6,6'-tetramethoxy-4,4'-bis(di-phenylphosphino)-3,3'-bipyridine] [(1R,2R)(+)-1,2-diphenylethylenediamine]ruthenium(II), min. 95% (478308-91-7) RuCl₂[C₃₈H₃₄N₂O₄P₂][C₁₄H₁₆N₂]; FW: 1028.90; yellow solid <i>air sensitive</i> Note: Sold in collaboration with Johnson Matthey for research purposes only. US patent Application No US Patent 5 886 182, 1999 and patents arising therefrom. PCT/JP96/03573. For detailed technical note visit strem.com.</p>		100mg 500mg
44-0386	<p>Dichloro[(S)(-)-2,2',6,6'-tetramethoxy-4,4'-bis(diphenylphosphino)-3,3'-bipyridine] [(1S,2S)(-)-1,2-diphenylethylenediamine]ruthenium(II), min. 95% (821793-36-6) RuCl₂[C₃₈H₃₄N₂O₄P₂][C₁₄H₁₆N₂]; FW: 1028.90; yellow solid <i>air sensitive</i> Note: Sold in collaboration with Johnson Matthey for research purposes only. US patent Application No US Patent 5 886 182, 1999 and patents arising therefrom. PCT/JP96/03573. For detailed technical note visit strem.com.</p>		100mg 500mg
44-0390	<p>Dichloro[(R)(+)-2,2',6,6'-tetramethoxy-4,4'-bis(di(3,5-xylyl)phosphino)-3,3'-bipyridine] [(1R,2R)(+)-1,2-diphenylethylenediamine]ruthenium(II), min. 95% (478308-93-9) RuCl₂[C₄₆H₅₀N₂O₄P₂][C₁₄H₁₆N₂]; FW: 1141.11; yellow solid <i>air sensitive</i> Note: Sold in collaboration with Johnson Matthey for research purposes only. US patent Application No US Patent 5 886 182, 1999 and patents arising therefrom. For detailed technical note visit strem.com.</p>		100mg 500mg
44-0391	<p>Dichloro[(S)(-)-2,2',6,6'-tetramethoxy-4,4'-bis(di(3,5-xylyl)phosphino)-3,3'-bipyridine] [(1S,2S)(-)-1,2-diphenylethylenediamine]ruthenium(II), min. 95% (821793-37-7) RuCl₂[C₄₆H₅₀N₂O₄P₂][C₁₄H₁₆N₂]; FW: 1141.11; yellow solid <i>air sensitive</i> Note: Sold in collaboration with Johnson Matthey for research purposes only. US patent Application No US Patent 5 886 182, 1999 and patents arising therefrom. For detailed technical note visit strem.com.</p>		100mg 500mg
44-0450	<p>Dichlorotricarbonylruthenium(II) dimer, min. 98% (22594-69-0) [RuCl₂(CO)₃]₂; FW: 512.02; off-white xtl.; m.p. 208° dec.</p>		100mg 500mg 2g
44-0500	<p>Dichlorotris(triphenylphosphine)ruthenium(II), 99% (15529-49-4) RuCl₂(P(C₆H₅)₃)₃; FW: 958.85; black xtl. <i>air sensitive</i></p>		1g 5g 25g

RUTHENIUM (Compounds)

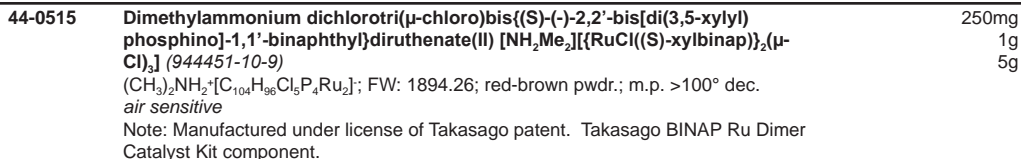
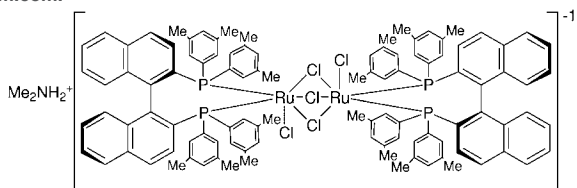
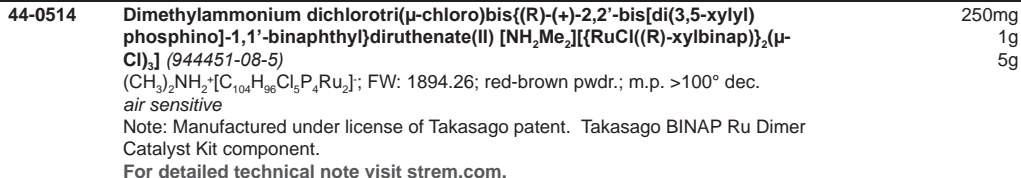
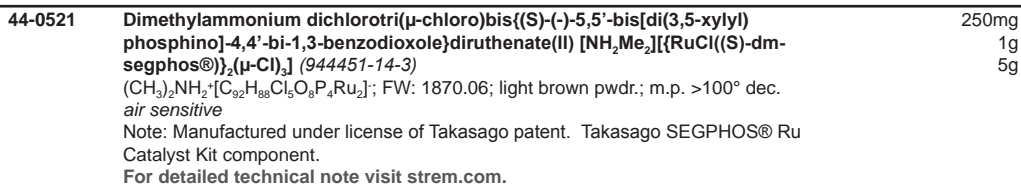
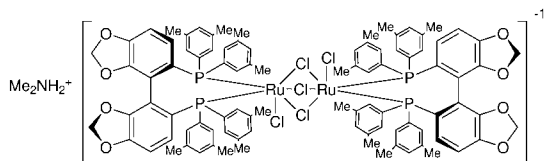
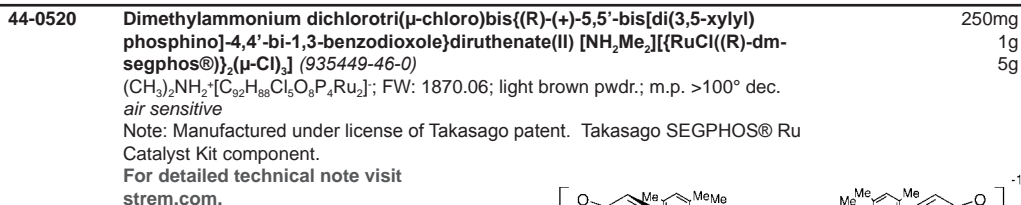
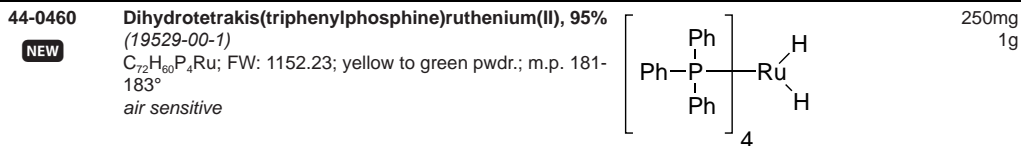

Technical Note:

- See 44-0514 (page 394)

RUTHENIUM (Compounds)

- 44-0518** Dimethylammonium dichlorotri(μ-chloro)bis[(R)-(+)-5,5'-bis(diphenylphosphino)-4,4'-bi-1,3-benzodioxole]diruthenate(II) [NH₂Me₂] 250mg
1g
5g
 {[RuCl((R)-segphos®)₂(μ-Cl)₃] (346457-41-8)}
 (CH₃)₂NH₂⁺[C₇₆H₄₈Cl₅O₈P₄Ru₂]; FW: 1637.57; light brown powdr.; m.p. >100° dec.
air sensitive
 Note: Manufactured under license of Takasago patent. Takasago SEGPHOS® Ru Catalyst Kit component.
 For detailed technical note visit strem.com.

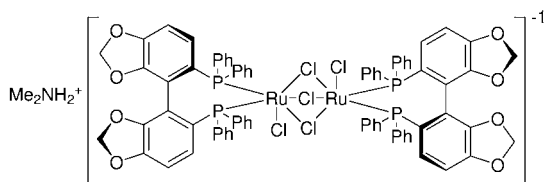

- 44-0519** Dimethylammonium dichlorotri(μ-chloro)bis[(S)-(-)-5,5'-bis(diphenylphosphino)-4,4'-bi-1,3-benzodioxole]diruthenate(II) [NH₂Me₂] 250mg
1g
5g
 {[RuCl((S)-segphos®)₂(μ-Cl)₃] (488809-34-3)}
 (CH₃)₂NH₂⁺[C₇₆H₄₈Cl₅O₈P₄Ru₂]; FW: 1637.57; light brown powdr.; m.p. >100° dec.
air sensitive
 Note: Manufactured under license of Takasago patent. Takasago SEGPHOS® Ru Catalyst Kit component.
 For detailed technical note visit strem.com.

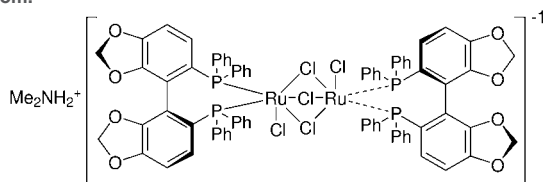

- 44-0510** Dimethylammonium dichlorotri(μ-chloro)bis[(R)-(+)-2,2'-bis(diphenylphosphino)-1,1'-binaphthyl]diruthenate(II) [NH₂Me₂][{RuCl((R)-binap)}₂(μ-Cl)₃] (199684-47-4) 250mg
1g
5g
 (CH₃)₂NH₂⁺[C₈₈H₆₄Cl₅P₄Ru₂]; FW: 1669.83; orange powdr.; m.p. >100° dec.
air sensitive
 Note: Manufactured under license of Takasago patent. Takasago BINAP Ru Dimer Catalyst Kit component.
 For detailed technical note visit strem.com.

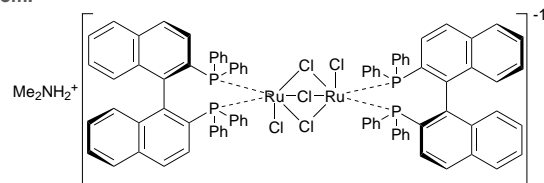

- 44-0511** Dimethylammonium dichlorotri(μ-chloro)bis[(S)-(-)-2,2'-bis(diphenylphosphino)-1,1'-binaphthyl]diruthenate(II) [NH₂Me₂][{RuCl((S)-binap)}₂(μ-Cl)₃] (199541-17-8) 250mg
1g
5g
 (CH₃)₂NH₂⁺[C₈₈H₆₄Cl₅P₄Ru₂]; FW: 1669.83; orange powdr.; m.p. >100° dec.
air sensitive
 Note: Manufactured under license of Takasago patent. Takasago BINAP Ru Dimer Catalyst Kit component.
 For detailed technical note visit strem.com.

RUTHENIUM (Compounds)

44-0516	<p>Dimethylammonium dichlorotri(μ-chloro)bis[(R)-(+)-2,2'-bis(diphenylphosphino)-5,5',6,6',7,7',8,8'-octahydro-1,1'-binaphthyl]diruthenate(II) [NH₂Me₂][{RuCl((R)-H₈-binap)}₂(μ-Cl)₃] (204933-84-6) (CH₃)₂NH₂⁺[C₈₈H₈₀Cl₅P₄Ru₂]; FW: 1685.96; red-brown powdr.; m.p. >100° dec. <i>air sensitive</i> Note: Manufactured under license of Takasago patent. For detailed technical note visit strem.com.</p>	50mg 250mg
44-0517	<p>Dimethylammonium dichlorotri(μ-chloro)bis[(S)-(-)-2,2'-bis(diphenylphosphino)-5,5',6,6',7,7',8,8'-octahydro-1,1'-binaphthyl]diruthenate(II) [NH₂Me₂][{RuCl((S)-H₈-binap)}₂(μ-Cl)₃] (944451-12-1) (CH₃)₂NH₂⁺[C₈₈H₈₀Cl₅P₄Ru₂]; FW: 1685.96; red-brown powdr.; m.p. >100° dec. <i>air sensitive</i> Note: Manufactured under license of Takasago patent. For detailed technical note visit strem.com.</p>	50mg 250mg
44-0512	<p>Dimethylammonium dichlorotri(μ-chloro)bis[(R)-(+)-2,2'-bis(dip-tolylphosphino)-1,1'-binaphthyl]diruthenate(II) [NH₂Me₂][{RuCl((R)-tolbinap)}₂(μ-Cl)₃] (749935-02-2) (CH₃)₂NH₂⁺[C₉₆H₈₀Cl₅P₄Ru₂]; FW: 1782.05; brown powdr.; m.p. >100° dec. <i>air sensitive</i> Note: Manufactured under license of Takasago patent. Takasago BINAP Ru Dimer Catalyst Kit component. For detailed technical note visit strem.com.</p>	250mg 1g 5g
44-0513	<p>Dimethylammonium dichlorotri(μ-chloro)bis[(S)-(-)-2,2'-bis(dip-tolylphosphino)-1,1'-binaphthyl]diruthenate(II) [NH₂Me₂][{RuCl((S)-tolbinap)}₂(μ-Cl)₃] (309735-86-2) (CH₃)₂NH₂⁺[C₉₆H₈₀Cl₅P₄Ru₂]; FW: 1782.05; brown powdr.; m.p. >100° dec. <i>air sensitive</i> Note: Manufactured under license of Takasago patent. Takasago BINAP Ru Dimer Catalyst Kit component.</p>	250mg 1g 5g
Technical Note:		
1. See 44-0512 (page 396)		
44-0186	<p>N-[(1S,2S)-1,2-Diphenyl-2-(4-methylbenzyloxy)ethylamino]ethyl]-4-methylbenzene sulfonamide(chloro)ruthenium(II) (S,S)-Ts-DENETM (1384974-37-1) C₃₁H₃₃ClN₂O₃RuS; FW: 650.19; gray to brown solid <i>air sensitive</i> Note: Manufactured under license of Takasago patent application PCT/JP2011/064490. For detailed technical note visit strem.com.</p>	250mg 1g 5g
96-3705	<p>EnantioTech BIMA^H Ru BINAP Catalyst Kit for Asymmetric Hydrogenation See page 481</p>	
96-3715	<p>EnantioTech BIMA^H Ru DIOP Catalyst Kit for Asymmetric Hydrogenation See page 482</p>	
96-3710	<p>EnantioTech BIMA^H Ru Tol-BINAP Catalyst Kit for Asymmetric Hydrogenation See page 483</p>	

RUTHENIUM (Compounds)

44-0610 NEW	Hexaamineruthenium(II) chloride, 98% (15305-72-3) Ru(NH ₃) ₆ Cl ₂ ; FW: 274.16; pale yellow pwdr. <i>air sensitive</i>	250mg 1g 5g
44-0620	Hexaamineruthenium(III) chloride, 99% (14282-91-8) Ru(NH ₃) ₆ Cl ₃ ; FW: 309.61; pale yellow pwdr.	250mg 1g 5g
44-0700	Hexakis[μ-(acetato-O·O')]-triaqua-μ3-oxotriruthenium(III), min. 95% (Ruthenium(III) acetate) (38998-79-7) [Ru ₃ O(OOCCH ₃) ₆ (H ₂ O) ₃] ⁺ OOCCH ₃ ; FW: 786.57; green pwdr.	1g 5g
44-0780	1-Hydroxytetraphenylcyclopentadienyl(tetraphenyl-2,4-cyclopentadien-1-one)-μ-hydroxotetracarboxydiruthenium(II), 98% SHVO'S CATALYST (104439-77-2) C ₆₂ H ₄₂ O ₈ Ru ₂ ; FW: 1085.13; orange pwdr. For detailed technical note visit strem.com .	100mg 500mg 2g
44-7778	3-Phenyl-1H-inden-1-ylidene[bis(i-butylphoban)]ruthenium(II) dichloride (894423-99-5) C ₃₀ H ₅₆ Cl ₂ P ₂ Ru; FW: 758.78; red pwdr. Note: Sold in collaboration with Umicore for research purposes only. Patent US 10,518,716. For detailed technical note visit strem.com .	250mg 1g
44-0111	{N-[3-(η6-phenyl)propyl]-[(1R-2R)-1,2-diphenyl-1-4-methylbenzenesulfonylamidato(kN')-ethyl-2-amino-(kN)]}ruthenium(II) (R,R)-Teth-TsDpen RuCl WILLIS CATALYST (1192620-83-9) C ₃₀ H ₃₁ ClN ₂ O ₂ RuS; FW: 620.17; orange pwdr. <i>air sensitive</i> Note: Sold in collaboration with JM for research purposes only. For detailed technical note visit strem.com .	100mg 500mg
44-0110	{N-[3-(η6-phenyl)propyl]-[(1S-2S)-1,2-diphenyl-1-4-methylbenzenesulfonylamidato(kN')-ethyl-2-amino-(kN)]}ruthenium(II) (S,S)-Teth-TsDpen RuCl WILLIS CATALYST (851051-43-9) C ₃₀ H ₃₁ ClN ₂ O ₂ RuS; FW: 620.17; orange pwdr. <i>air sensitive</i> Note: Sold in collaboration with JM for research purposes only. For detailed technical note visit strem.com .	100mg 500mg
44-1700	Potassium hexacyanoruthenate(II) hydrate (15002-31-0) See page 342	
93-1987	Potassium pentachlororuthenate(III) hydrate (14404-33-2) See page 343	
44-1750	Potassium perruthenate, 98% (10378-50-4) See page 343	

RUTHENIUM (Compounds)

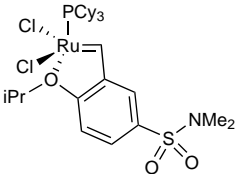
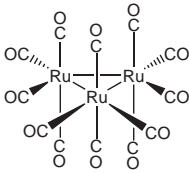
44-0078	{[2-(i-Propoxy)-5-(N,N-dimethylaminosulfonyl)phenyl]methylene}(tricyclohexylphosphine) ruthenium(II) dichloride Zhan Catalyst -1C (918871-44-0) C ₃₀ H ₅₀ Cl ₂ NO ₃ PRuS; FW: 707.74; brown solid Note: Sold under license from Zannan for re-search purposes only. Patents CN1907992A, US 2007/0043180 A1, PCT WO 2007/003135 A1. For detailed technical note visit strem.com .		500mg 2g
44-1800	Ruthenium(III) acetylacetonate, 99% (14284-93-6) Ru(CH ₃ COCHCOCH ₃) ₃ ; FW: 398.40; red to brown xtl.; m.p. 230-235°		1g 5g
44-1825	Ruthenium(III) bromide hydrate (14014-88-1) RuBr ₃ ·XH ₂ O; FW: 340.80; black xtl.		1g 5g
44-1850	Ruthenium carbonyl, 99% (15243-33-1) Ru ₃ (CO) ₁₂ ; FW: 639.34; orange xtl.; m.p. 150° dec. For detailed technical note visit strem.com .		1g 5g 25g
44-5850	Ruthenium(III) chloride, anhydrous (10049-08-8) HAZ RuCl ₃ ; FW: 207.43; black powdr.; m.p. >500° dec. <i>hygroscopic</i>		1g 5g 25g
44-5880	Ruthenium(III) chloride hydrate (40-43% Ru) (99.9%-Ru) (14898-67-0) HAZ RuCl ₃ ·XH ₂ O; FW: 207.43; black powdr.; m.p. 100° (dec.) <i>hygroscopic</i>		1g 5g 25g
44-5885	Ruthenium(III) chloride hydrate (40-43% Ru) (99.99%-Ru) PURATREM [free of Ru(II) and Ru(IV) by electrochemical analysis] (14898-67-0) NEW HAZ RuCl ₃ ·XH ₂ O; FW: 207.43; black powdr. <i>hygroscopic</i>		1g 5g
44-2500	Ruthenium(III) iodide, anhydrous, 98+% (13896-65-6) RuI ₃ ; FW: 481.78; black xtl.		1g 5g
44-3815	Ruthenium(III) nitrosyl chloride monohydrate, 99% (18902-42-6) Ru(NO)Cl ₃ ·H ₂ O; FW: 237.44 (255.46); red xtl. <i>hygroscopic</i>		1g 5g
44-3800	Ruthenium(III) nitrosyl nitrate, solution (1.5% Ru) (34513-98-9) HAZ Ru(NO)(NO ₃) ₃ ; FW: 317.09; orange to brown liq.		50g 250g 1kg
44-1977	Ruthenium(IV) oxide, anhydrous (99.9%-Ru) (12036-10-1) RuO ₂ ; FW: 133.07; black powdr.; m.p. dec.; d. 6.97		1g 5g
44-1980	Ruthenium(IV) oxide hydrate (32740-79-7) RuO ₂ ·XH ₂ O; FW: 133.07; -100 mesh black powdr.; SA: high		1g 5g
44-2000	Ruthenium(VIII) oxide (0.5% stabilized aqueous solution) (20427-56-9) amp HAZ RuO ₄ ; FW: 165.70; yellow liq. <i>heat sensitive, (store cold)</i>		10ml 5 x 10ml
96-6955	Takasago ATH (Asymmetric Transfer Hydrogenation) Catalyst Kit See page 490		
96-6953	Takasago BINAP Ru Acetate Catalyst Kit See page 492		
96-6951	Takasago BINAP Ru Cymene Catalyst Kit See page 493		
96-6954	Takasago BINAP Ru Diamine Catalyst Kit See page 494		
96-6952	Takasago BINAP Ru Dimer Catalyst Kit See page 495		
96-6901	Takasago SEGPPOS® Ru Catalyst Kit See page 496		

RUTHENIUM (Compounds)

44-7760	Tetrabutylammonium perruthenate, min. 97% TBAP (96317-72-5) See page 7	
44-7000	cis-Tetrakis(dimethylsulfoxide)dichlororuthenium(II), 98% (11070-19-2) RuCl ₂ [CH ₃ S(O)CH ₃] ₄ ; FW: 484.49; yellow powd.	250mg 1g 5g
44-7850	Tetrapropylammonium perruthenate, min. 97% TPAP (114615-82-6) See page 8	
44-7785	Tricyclohexylphosphine[1,3-bis(2,4,6-trimethylphenyl)imidazol-2-ylidene][2-thienylmethylene]ruthenium(II) dichloride, min. 95% [catMETium® RF 2] (1190427-49-6) C ₄₄ H ₆₁ Cl ₂ N ₂ PRuS; FW: 852.98; brown powd. Note: Sold in collaboration with Evonik for research purposes only. Patent US 6635768. For detailed technical note visit strem.com .	100mg 500mg 2g
44-7780	Tricyclohexylphosphine[1,3-bis(2,4,6-trimethylphenyl)imidazol-2-ylidene][4,5-dihydroimidazol-2-ylidene][phenylthio]methylene]ruthenium(II) dichloride (1155422-69-7) RuCl ₂ [C ₂₁ H ₂₆ N ₂][C ₇ H ₆ S][P(C ₆ H ₁₁) ₃]; FW: 881.04; purple-brown solid For detailed technical note visit strem.com .	100mg 500mg
44-7775	Tricyclohexylphosphine[1,3-bis(2,4,6-trimethylphenyl)imidazol-2-ylidene][3-phenyl-1H-inden-1-ylidene]ruthenium(II) dichloride, min. 95% [catMETium® RF 1] (254972-49-1) RuCl ₂ [C ₂₁ H ₂₆ N ₂][C ₁₅ H ₁₀][P(C ₆ H ₁₁) ₃]; FW: 947.07; orange to brown powd. Note: Sold in collaboration with Evonik for research purposes only. Patent US 6635768. For use in pharmaceutical applications only. Other uses are unauthorized. For detailed technical note visit strem.com .	100mg 500mg 2g
44-7795	Tricyclohexylphosphine[2,4-dihydro-2,4,5-triphenyl-3H-1,2,4-triazol-3-ylidene][2-thienylmethylene]ruthenium(II) dichloride, min. 95% [catMETium® RF 4] (1190427-51-0) C ₄₃ H ₅₂ Cl ₂ N ₃ PRuS; FW: 845.91; violet to brown powd. Note: Sold in collaboration with Evonik for research purposes only. Patent US 6635768. For detailed technical note visit strem.com .	100mg 500mg 2g

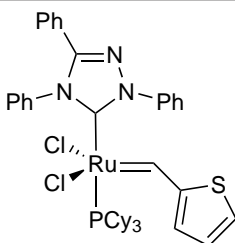
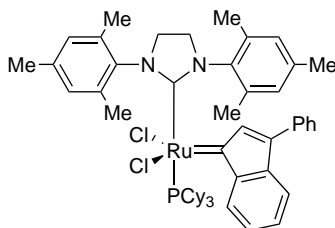
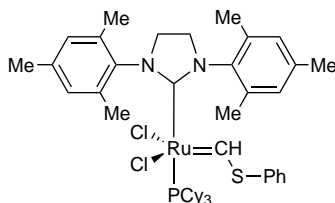
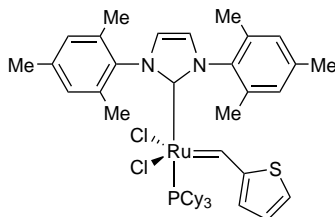

RUTHENIUM (Compounds)

44-7790	<p>Tricyclohexylphosphine[4,5-dimethyl-1,3-bis(2,4,6-trimethylphenyl)imidazol-2-ylidene][2-thienylmethylene]ruthenium(II) dichloride, min. 95% [catME-Tium® RF 3] (1190427-50-9) $C_{46}H_{65}Cl_2N_2PRuS$; FW: 881.04; violet to brown powdr. Note: Sold in collaboration with Evonik for research purposes only. Patent US 6635768. For detailed technical note visit strem.com.</p>		100mg 500mg 2g
44-7777	<p>Tricyclohexylphosphine[3-phenyl-1H-inden-1-ylidene][1,3-bis(2,4,6-trimethylphenyl)-4,5-dihydroimidazol-2-ylidene]ruthenium(II) dichloride, min. 95% (536724-67-1) $C_{54}H_{69}Cl_2N_2PRu$; FW: 949.09; dark red powdr. Note: Sold in collaboration with Umicore for research purposes only. For use in lifesience applications and research purposes only. For detailed technical note visit strem.com.</p>		100mg 500mg
44-7783	<p>Tri(i-propoxy)phosphine(3-phenyl-1H-inden-1-ylidene)[1,3-bis(2,4,6-trimethylphenyl)-4,5-dihydroimidazol-2-ylidene]ruthenium(II) dichloride, min. 95% cis-Caz-1 $C_{45}H_{57}Cl_2N_2O_3PRu$; FW: 876.89; brown powdr. For detailed technical note visit strem.com.</p>		50mg 250mg
44-7870	<p>Tris(acetonitrile)cyclopentadienylruthenium(II) hexafluorophosphate, min. 98% (80049-61-2) $C_5H_5Ru(CH_3CN)_3^+PF_6^-$; FW: 434.30; yellow to orange powdr.; m.p. 117-118° (dec.) <i>air sensitive, (store cold)</i> For detailed technical note visit strem.com.</p>		250mg 1g 5g
44-7880	<p>Tris(acetonitrile)pentamethylcyclopentadienylruthenium(II) hexafluorophosphate, min. 98% (99604-67-8) $[Ru(C_{10}H_{15})(CH_3CN)_3]^+PF_6^-$; FW: 504.42; yellow orange powdr. <i>air sensitive, (store cold)</i> For detailed technical note visit strem.com.</p>		50mg 250mg 1g
44-7890	<p>Tris(acetonitrile)pentamethylcyclopentadienylruthenium(II) trifluoromethanesulfonate, min. 98% (113860-02-9) $[Ru(C_{10}H_{15})(CH_3CN)_3]^+CF_3SO_3^-$; FW: 508.52; orange powdr. <i>air sensitive, (store cold)</i> For detailed technical note visit strem.com.</p>		250mg 1g

RUTHENIUM (Compounds)

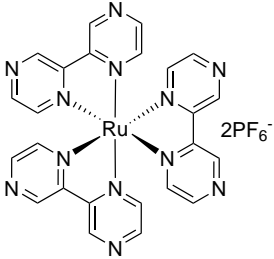
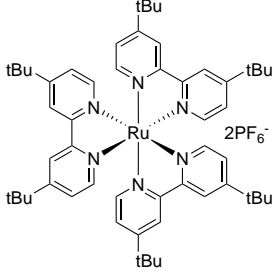
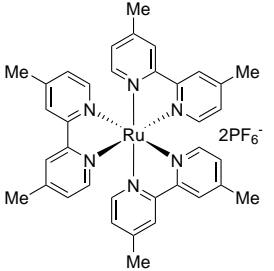
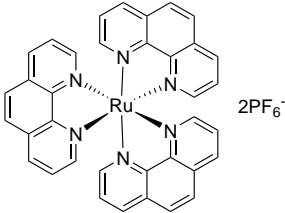
44-7910	Tris(2,2'-bipyrazine)ruthenium(II) hexafluorophosphate, 95% (80907-56-8) C ₂₄ H ₁₈ F ₁₂ N ₁₂ P ₂ Ru; FW: 865.48; red powdr. <i>air sensitive</i> Note: Photocatalyst. For detailed technical note visit strem.com .	50mg 250mg
		
44-7900	Tris(2,2'-bipyridyl)ruthenium(II) chloride hexahydrate, min. 98% (50525-27-4) Ru(C ₁₀ H ₈ N ₂) ₃ Cl ₂ ·6H ₂ O; FW: 640.54 (748.63); orange to red xtl.	1g 5g
44-7940	Tris[4,4'-bis(t-butyl)-2,2'-bipyridine] ruthenium(II) hexafluorophosphate, 95% (75777-87-6) C ₅₄ H ₇₂ F ₁₂ N ₆ RuP ₂ ; FW: 1196.19; red powdr. <i>air sensitive</i> Note: Photocatalyst. For detailed technical note visit strem.com .	50mg 250mg
		
44-7930	Tris(4,4'-dimethyl-2,2'-bipyridine)ruthenium(II) hexafluorophosphate, 95%, DMBPY (83605-44-1) C ₃₆ H ₃₆ F ₁₂ N ₆ RuP ₂ ; FW: 943.71; red powdr. <i>air sensitive</i> Note: Photocatalyst.	50mg 250mg
		
44-7955	Tris(1,10-phenanthroline)ruthenium(II) hexafluorophosphate, 95% (60804-75-3) C ₃₆ H ₂₄ F ₁₂ N ₆ RuP ₂ ; FW: 931.62; red powdr. <i>air sensitive</i> Note: Photocatalyst	50mg 250mg
		
44-8000	Tris(2,2,6,6-tetramethyl-3,5-heptanedionato)ruthenium(III), 99% (99.9%-Ru) [Ru(TMHD)₃] (38625-54-6) Ru(C ₁₁ H ₁₉ O ₂) ₃ ; FW: 650.88; orange powdr.; m.p. 210-213°; b.p. dec. 250° (subl. 120°/0.5mm)	1g 5g

SAMARIUM (Elemental Forms)

93-6236	Samarium chips (99.9% REO) (7440-19-9) Sm; FW: 150.4; m.p. 1072°; b.p. 1778°; d. 7.4 <i>air sensitive, moisture sensitive</i>	10g 50g
93-6240	Samarium foil (99.9% REO) (7440-19-9) Sm; FW: 150.4; 0.62 mm thick (~2.9g/25 x 25 mm); m.p. 1072°; b.p. 1778°; d. 7.4 <i>air sensitive, moisture sensitive</i>	25 x 25mm 50 x 50mm

SAMARIUM (Elemental Forms)

93-6237	Samarium ingot (99.9% REO) (7440-19-9) Sm; FW: 150.4; ingot; m.p. 1072°; b.p. 1778°; d. 7.4 <i>air sensitive, moisture sensitive</i>	25g 100g
93-6235 HAZ	Samarium powder (99.9% REO) (7440-19-9) Sm; FW: 150.4; -40 mesh; m.p. 1072°; b.p. 1778°; d. 7.4 <i>air sensitive, moisture sensitive</i>	1g 10g 50g
62-6235 NEW HAZ	Samarium powder (99.9% REO) 325 mesh (7440-19-9) Sm; FW: 140.4; 325 mesh; m.p. 1072°; b.p. 1778°; d. 7.40 <i>air sensitive, moisture sensitive</i>	5g 25g

SAMARIUM (Compounds)

93-6201	Samarium(III) acetate hydrate (99.9%-Sm) (REO) (100587-91-5) Sm(OOCH ₃) ₃ ·XH ₂ O; FW: 327.53; off-white powdr.	25g 100g
93-6226	Samarium(III) acetylacetonate hydrate (99.9%-Sm) (REO) (14589-42-5) Sm(CH ₃ COCHCOCH ₃) ₃ ·XH ₂ O; FW: 447.69; white to off-white powdr.	25g 100g
62-2000	Samarium(III) carbonate hydrate (99.9%-Sm) (REO) (5895-47-6) Sm ₂ (CO ₃) ₃ ·XH ₂ O; FW: 480.72; white to light yellow powdr.; m.p. >500° dec.	10g 50g
62-3000 amp	Samarium(III) chloride, anhydrous (99.9%-Sm) (REO) (10361-82-7) SmCl ₃ ; FW: 256.76; white to yellow powdr.; m.p. 686°; d. 4.465 <i>hygroscopic</i>	5g 25g 100g
93-6225	Samarium(III) chloride hexahydrate (99.9%-Sm) (REO) (13465-55-9) SmCl ₃ ·6H ₂ O; FW: 256.71 (364.80); light yellow xtl.	25g 100g
93-6205	Samarium(III) fluoride (99.9%-Sm) (REO) (13765-24-7) SmF ₃ ; FW: 207.35; off-white powdr.; m.p. 1306°; b.p. 2323°; d. 6.928 <i>hygroscopic</i>	5g 25g
62-3100 HAZ	Samarium(II) iodide, 0.1M in THF (32248-43-4) SmI ₂ ; FW: 404.21; liq. stabilized with Sm powdr.; d. 0.922 g/ml <i>air sensitive, moisture sensitive</i> Note: Free rubber septum included. For detailed technical note visit strem.com .	50ml 250ml
93-6206	Samarium(III) naphthenate (8-10% Sm) (61790-20-3) viscous liq.	25g 100g
93-6207 HAZ	Samarium(III) nitrate hexahydrate (99.9%-Sm) (REO) (13759-83-6) Sm(NO ₃) ₃ ·6H ₂ O; FW: 336.37 (444.47); yellow xtl. <i>hygroscopic</i>	25g 100g
93-6209	Samarium(III) oxalate hydrate (99.9%-Sm) (REO) (14175-03-2) Sm ₂ (C ₂ O ₄) ₃ ·XH ₂ O; FW: 564.76; white powdr.	10g 50g
93-6211	Samarium(III) oxide (99.9%-Sm) (REO) (12060-58-1) Sm ₂ O ₃ ; FW: 348.70; white to off-white powdr.; d. 8.347	25g 100g 500g
93-6231	Samarium(III) oxide (99.99%-Sm) (REO) PURATREM (12060-58-1) Sm ₂ O ₃ ; FW: 348.70; white to off-white powdr.; d. 8.347	5g 25g
93-6212 HAZ	Samarium(III) perchlorate, 50% aqueous solution (99.9%-Sm) (REO) (13569-60-3) Sm(ClO ₄) ₃ ; FW: 448.70; colorless liq.	2g 10g
93-6214 HAZ	Samarium(III) i-propoxide, min. 97% (99.9%-Sm) (REO) (3504-40-3) Sm(OC ₃ H ₇) ₃ ; FW: 1535.94; cream colored powdr. <i>moisture sensitive</i>	1g 5g 25g
93-6216	Samarium(III) sulfate octahydrate (99.9%-Sm) (REO) (13465-58-2) Sm ₂ (SO ₄) ₃ ·8H ₂ O; FW: 588.89 (733.01); colorless to pale yellow xtl.; d. 2.930	25g 100g
93-6219	Samarium(III) trifluoroacetylacetonate (99.9%-Sm) (REO) (23301-82-8) Sm(CF ₃ COCHCOCH ₃) ₃ ; FW: 609.59; white powdr.	1g 5g
62-3300	Samarium(III) trifluoromethanesulfonate, min. 98% (Samarium triflate) (52093-28-4) Sm(CF ₃ SO ₃) ₃ ; FW: 597.57; white to off-white powdr. <i>hygroscopic</i>	5g 25g

SAMARIUM (Compounds)

62-3500 amp HAZ	Tris(cyclopentadienyl)samarium (99.9%-Sm) (REO) (1298-55-1) (C ₅ H ₅) ₃ Sm; FW: 345.69; orange powdr.; m.p. 356° <i>air sensitive, moisture sensitive</i>	1g 5g
62-4000	Tris(2,2,6,6-tetramethyl-3,5-heptanedionato)samarium(III) (99.9%-Sm) (REO) [Sm(TMHD)]₃ (15492-50-9) Sm(C ₁₁ H ₁₉ O ₂) ₃ ; FW: 700.11; pale yellow xtl.; m.p. 191-193°; b.p. dec. 250° (subl. 183°/1.3mm)	1g 5g

SCANDIUM (Elemental Forms)

93-2122	Scandium lump, vacuum remelted (99.9% REO) (7440-20-2) Sc; FW: 44.956; lump; m.p. 1539°; b.p. 2730°; d. 3.0 <i>air sensitive</i>	500mg 2g
93-2120 HAZ	Scandium powder (99.9% REO) (7440-20-2) Sc; FW: 44.956; powdr.; m.p. 1539°; b.p. 2730°; d. 3.0 <i>air sensitive</i>	100mg 500mg 2g

SCANDIUM (Compounds)

93-2101	Scandium(III) acetate hydrate (99.9%-Sc) (REO) (3804-23-7) Sc(OOCCH ₃) ₃ ·XH ₂ O; FW: 222.10; white xtl.	1g 5g
93-2110	Scandium(III) carbonate hydrate (99.99%-Sc) (REO) PURATREM (5809-49-4) Sc ₂ (CO ₃) ₃ ·XH ₂ O; FW: 269.96; white powdr.	1g 5g
93-2102	Scandium (III) chloride, anhydrous (99.99%-Sc) (REO), sublimed, PURATREM (10361-84-9) ScCl ₃ ; FW: 151.32; white powdr.; m.p. 939°; d. 2.39 <i>hygroscopic</i>	250mg 1g 5g
93-2111	Scandium(III) chloride hexahydrate (99.9%-Sc) (REO) (20662-14-0) ScCl ₃ ·6H ₂ O; FW: 151.32 (259.41); white xtl.	1g 5g
93-2112	Scandium(III) fluoride (99.9%-Sc) (REO) (13709-47-2) ScF ₃ ; FW: 101.95; white powdr.; m.p. 1515° <i>hygroscopic</i>	1g 5g
93-2104 HAZ	Scandium(III) nitrate pentahydrate (99.9%-Sc) (REO) (13465-60-6) Sc(NO ₃) ₃ ·5H ₂ O; FW: 230.97 (321.05); white xtl.	1g 5g
93-2113	Scandium(III) oxide (99.9%-Sc) (REO) (12060-08-1) Sc ₂ O ₃ ; FW: 137.91; white powdr.; d. 3.864	1g 5g 25g
21-2112	Scandium(III) oxide (99.99%-Sc) (REO) PURATREM (12060-08-1) Sc ₂ O ₃ ; FW: 137.91; white powdr. (~7 micron); d. 3.864	1g 5g 25g
21-0750	Scandium(III) oxide, sintered lumps (99.9%-Sc) (REO) (12060-08-1) Sc ₂ O ₃ ; FW: 137.91; 6-25mm irregular pieces	1g 5g
21-2000	Scandium(III) trifluoromethanesulfonate, min. 98% (Scandium triflate) (144026-79-9) Sc(SO ₂ CF ₃) ₃ ; FW: 492.17; white powdr. <i>hygroscopic</i> For detailed technical note visit strem.com .	250mg 1g 5g
21-2004	Scandium(III) trifluoromethanesulfonate (Scandium triflate), Microencapsulated in a Styrene Polymer [~13% Sc(SO₂CF₃)₃] Sc(SO ₂ CF ₃) ₃ ; white solid For detailed technical note visit strem.com .	500mg
21-2023	Scandium(III) trifluoromethanesulfonimide, min. 97% (176726-07-1) Sc(C ₂ F ₈ NO ₂ S ₂) ₃ ; FW: 885.40; white powdr. <i>hygroscopic</i>	250mg 1g
21-1000	Tris(2,2,6,6-tetramethyl-3,5-heptanedionato)scandium(III), 99% (99.9%-Sc) (REO) [Sc(TMHD)]₃ (15492-49-6) Sc(C ₁₁ H ₁₉ O ₂) ₃ ; FW: 594.77; white powdr.; m.p. 150-152°; b.p. dec. 275°	500mg 2g

SELENIUM (Elemental Forms)

93-3416 HAZ	Selenium powder (99.5%) (7782-49-2) Se; FW: 78.96; -200 mesh; m.p. 170-217°; b.p. 690°; d. 4.81	25g 100g 500g
----------------	---	---------------------

SELENIUM (Elemental Forms)

34-0090	Selenium powder (99.99%) (7782-49-2)	100g
HAZ	Se; FW: 78.96; -200 mesh; m.p. 170-217°; b.p. 690°; d. 4.81	500g
93-3417	Selenium shot (99.99%) (7782-49-2)	50g
HAZ	Se; FW: 78.96; gray pellets (~2mm dia.); m.p. 170-217°; b.p. 690°; d. 4.81	250g

SELENIUM (Compounds)

34-0380	Diethyldiselenide, min. 97% (628-39-7)	2g
HAZ	C ₂ H ₅ SeSeC ₂ H ₅ ; FW: 216.04; red-brown liq.; b.p. 85°/21mm <i>air sensitive, (store cold), STENCH</i>	10g 50g
34-0550	Dimethylselenide, 99% (593-79-3)	10g
amp HAZ	(CH ₃) ₂ Se; FW: 109.03; colorless to yellow liq.; b.p. 57-58°; d. 1.4077 <i>air sensitive, heat sensitive, (store cold), STENCH</i>	50g
34-0650	Diphenyldiselenide, 98% (1666-13-3)	5g
HAZ	C ₆ H ₅ SeSeC ₆ H ₅ ; FW: 312.13; yellow powdr.; m.p. 59-62°	25g
34-0700	Diphenylselenide (1132-39-4)	2g
HAZ	(C ₆ H ₅) ₂ Se; FW: 233.17; amber liq.; m.p. 3°; b.p. 165-167°/12 mm; d. 1.338 <i>STENCH</i>	10g
34-1400	Phenylselenium chloride (5707-04-0)	2g
HAZ	C ₆ H ₅ SeCl; FW: 191.52; red xtl.; m.p. 64-65°; b.p. 92°/5 mm <i>moisture sensitive</i>	10g
34-1600	Phenylselenol, 97% (645-96-5)	1g
HAZ	C ₆ H ₅ SeH; FW: 157.07; colorless to light yellow liq.; b.p. 67-68°/12 mm; f.p. 158°F; d. 1.479 <i>air sensitive, STENCH</i>	5g
93-3420	Selenic acid, 40% solution (7783-08-6)	50g
HAZ	H ₂ SeO ₄ ; FW: 144.97; colorless liq.	250g
93-3410	Selenium(IV) bromide, 99% (7789-65-3)	5g
HAZ	SeBr ₄ ; FW: 398.6; reddish black xtl.; m.p. 75° dec. <i>moisture sensitive</i>	25g
93-3404	Selenium(II) chloride (99%-Se) (10025-68-0)	10g
HAZ	Se ₂ Cl ₂ ; FW: 228.53; red liq.; m.p. -85°; b.p. 130° dec.; d. 2.77 <i>moisture sensitive</i>	50g
93-3411	Selenium(IV) chloride (99.8%-Se) (10026-03-6)	10g
HAZ	SeCl ₄ ; FW: 220.77; -8 mesh yellow powdr.; m.p. 196° subl.; b.p. 288° dec.; d. 1.807 <i>moisture sensitive</i>	50g
93-3408	Selenium dichloride oxide, 97% (7791-23-3)	5g
HAZ	SeOCl ₂ ; FW: 165.87; yellow to orange liq.; m.p. 8.5°; b.p. 176.4°; d. 2.42 <i>moisture sensitive</i>	25g
93-3406	Selenium(IV) oxide, 99.8% (7446-08-4)	100g
HAZ	SeO ₂ ; FW: 110.96; off-white powdr.; b.p. 340-350° subl.; d. 3.95	500g
93-3405	Selenium(IV) oxide (99.999%-Se) PURATREM (7446-08-4)	5g
HAZ	SeO ₂ ; FW: 110.96; off-white powdr.; b.p. 340-350° subl.; d. 3.95	25g
93-3415	Selenium(IV) sulfide, min. 94% (7488-56-4)	25g
HAZ	SeS ₂ ; FW: 143.09; red powdr.; m.p. < 100°; b.p. dec.	100g
34-1900	Selenourea, 99+% (630-10-4)	1g
HAZ	NH ₂ CSeNH ₂ ; FW: 123.02; pink solid; m.p. 200° dec. <i>air sensitive, light sensitive, (store cold)</i>	5g 25g
34-0100	Selenous acid (99.999%-Se) PURATREM (7783-00-8)	25g
HAZ	H ₂ SeO ₃ ; FW: 128.97; white xtl.; m.p. 70° dec.; d. 3.004 <i>hygroscopic</i>	100g

SILICON (Elemental Forms)

14-0600	Silicon chips (99.9999%) (7440-21-3)	100g
	Si; FW: 28.09; 1-3 mm; m.p. 1420°; b.p. 2600°; d. 2.42	500g
93-1496	Silicon powder (99+% (7440-21-3)	100g
HAZ	Si; FW: 28.09; -325 mesh; m.p. 1420°; b.p. 2600°; d. 2.42	500g
14-0700	Silicon powder (99.999%) (7440-21-3)	25g
HAZ	Si; FW: 28.09; -325 mesh; m.p. 1420°; b.p. 2600°; d. 2.42	100g 500g

SILICON (Elemental Forms)

14-0655 HAZ	Silicon powder (amorphous), min. 97% (7440-21-3) Si; brown pwdr.; SA: >50 m ² /g <i>air sensitive</i>	5g 25g
14-0650	Silicon powder (nanocrystalline), min. 97% (7440-21-3) See page 165	
93-1495	Silicon random pieces (99.5%) (7440-21-3) Si; FW: 28.09; 1/2" and down; m.p. 1420°; b.p. 2600°; d. 2.42	500g 2kg

SILICON (Compounds)

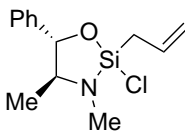
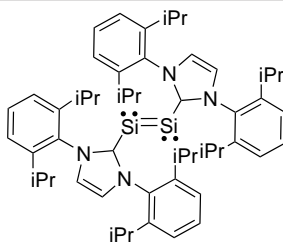
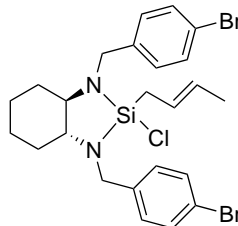
14-1815	(4S,5S)-2-Allyl-2-chloro-3,4-dimethyl-5-phenyl-1-oxa-3-aza-2-silacyclopentane, min. 98% (~2:1 mixture of diastereomers) (447440-43-9) C ₁₃ H ₁₈ ClNOSi; FW: 267.83; colorless oil <i>moisture sensitive, (store cold)</i> Note: Patent WO 03/074534, WO 06/062901. For detailed technical note visit strem.com .		1g 5g
93-1402 HAZ	3-Aminopropyltriethoxysilane, 98% (919-30-2) H ₂ N(CH ₂) ₃ Si(OC ₂ H ₅) ₃ ; FW: 221.38; colorless liq.; b.p. 217°; f.p. 220°F; d. 0.943 <i>moisture sensitive</i> Note: Available prepacked in ALD cylinder- see 98-4036, 98-4037.	100g 500g	
98-4036 HAZ	3-Aminopropyltriethoxysilane, 98%, 93-1402, contained in 50 ml Swagelok® cylinder (96-1070) for CVD/ALD (919-30-2) H ₂ N(CH ₂) ₃ Si(OC ₂ H ₅) ₃ ; FW: 221.38; colorless liq.; m.p. 300°; b.p. 217°; f.p. 220°F; d. 0.943 <i>moisture sensitive</i> Note: High temperature Swagelok® cylinder assembly 96-1071 available at extra cost. See 98-4037.	25g	
98-4037 HAZ	3-Aminopropyltriethoxysilane, 98%, 93-1402, contained in high-temp 50 ml Swagelok® cylinder (96-1071) for CVD/ALD (919-30-2) H ₂ N(CH ₂) ₃ Si(OC ₂ H ₅) ₃ ; colorless liq.; b.p. 217°; f.p. 220°F; d. 0.943 <i>moisture sensitive</i>	25g	
14-1050	1,2-Bis[1,3-bis(2,6-di-i-propylphenyl)imidazol-2-ylidene]disilene (1070876-63-9) C ₅₄ H ₇₂ N ₄ Si ₂ ; FW: 833.35; red xtl. <i>air sensitive</i> Note: Sold under license from the University of Georgia Research Foundation, Inc. for research purposes only. US Patent 8,278,456. For detailed technical note visit strem.com .		50mg 250mg
14-1883	(1R,2R)-(-)-[N,N'-Bis(4-bromobenzyl)-1,2-cyclohexanediamino][(2E)-2-buten-1-yl]chlorosilane, min. 98% (804559-39-5) C ₂₄ H ₂₉ Br ₂ ClN ₂ Si; FW: 568.85; white solid; m.p. 92-96° <i>moisture sensitive</i> Note: Patent WO 03/074534, WO 06/062901.		250mg 1g
14-1884	(1S,2S)-(+)-[N,N'-Bis(4-bromobenzyl)-1,2-cyclohexanediamino][(2E)-2-buten-1-yl]chlorosilane, min. 98% (1072220-37-1) C ₂₄ H ₂₉ Br ₂ ClN ₂ Si; FW: 568.85; white solid; m.p. 92-96° <i>moisture sensitive</i> Note: Patent WO 03/074534, WO 06/062901.	250mg 1g	
14-1060 amp HAZ	Bis(t-butylamino)silane, 97+% BTBAS (186598-40-3) [NH(C ₄ H ₉) ₂ SiH ₂]; FW: 174.36; colorless liq.; b.p. 167°C; f.p. 30°F; d. 0.816 <i>moisture sensitive, (store cold)</i>	1g 5g 25g	

SILICON (Compounds)

14-1072 NEW	Bis(<i>n</i>-butylamino)silane, BTBAS (99.999%-Si) PURATREM (186598-40-3) C ₈ H ₂₂ N ₂ Si; FW: 174.36; colorless liq.; b.p. 167°C; f.p. 30°C; d. 0.816 <i>moisture sensitive</i>	1g 5g 25g
14-7030 HAZ	Bis(diethylamino)silane, 97% BDEAS (27804-64-4) SiH ₂ [N(CH ₂ CH ₃) ₂] ₂ ; FW: 174.36; colorless liq.; b.p. 70° (30mm); d. 0.804 <i>air sensitive, moisture sensitive</i> For detailed technical note visit strem.com .	5g 25g
98-8810 NEW HAZ	Bis(diethylamino)silane, 99% (99.999%-Si) BDEAS PURATREM (27804-64-4) SiH ₂ [N(CH ₂ CH ₃) ₂] ₂ ; FW: 174.36; colorless liq. <i>air sensitive, moisture sensitive</i>	5g 25g
14-1000 HAZ	Bis(trimethylsilyl)acetylene, min. 97% (14630-40-1) (CH ₃) ₃ SiC≡CSi(CH ₃) ₃ ; FW: 170.40; colorless liq.; m.p. 22-23°; b.p. 133-135°; f.p. 37°F; d. 0.752	10g 50g
14-1500 HAZ	Bis(trimethylsilyl)methane, 97% (2117-28-4) [(CH ₃) ₃ Si] ₂ CH ₂ ; FW: 160.41; colorless liq.; m.p. -71°; b.p. 133-134°; f.p. 55°F; d. 0.751	1g 5g
14-1015 HAZ	Bis(trimethylsilyl)sulfide, min. 98% (3385-94-2) (CH ₃) ₃ SiSSi(CH ₃) ₃ ; FW: 178.44; colorless liq.; b.p. 164°; d. 0.846 <i>(store cold), STENCH</i>	1g 5g 25g
14-1775 HAZ	<i>t</i>-Butyldimethylchlorosilane, min. 97% (18162-48-6) (CH ₃) ₂ Si(CH ₂) ₂ Cl; FW: 150.70; white powdr.; m.p. 86-89°; b.p. 125°; f.p. 73°F	10g 50g
14-1800 HAZ	<i>t</i>-Butyldimethylsilyl trifluoromethanesulfonate, 98% (69739-34-0) (C ₄ H ₉)(CH ₃) ₂ Si(SO ₂ CF ₃); FW: 264.34; clear liq.; f.p. 98°F; d. 1.151 <i>moisture sensitive</i>	1g 5g 25g
93-1403 amp HAZ	<i>n</i>-Butyltrichlorosilane (7521-80-4) (C ₄ H ₉)SiCl ₃ ; FW: 191.50; colorless liq.; b.p. 142°; f.p. 130°F; d. 1.160 <i>moisture sensitive</i>	10g 50g
14-1810	(4<i>S</i>,5<i>S</i>)-2-Chloro-3,4-dimethyl-2,5-diphenyl-1-oxa-3-aza-2-silacyclopentane, min. 98% (~2:1 mixture of diastereomers) (680592-40-9) C ₁₆ H ₁₈ ClNOSi; FW: 303.86; colorless oil <i>moisture sensitive, (store cold)</i> Note: Patent WO 03/074534, WO 06/062901. For detailed technical note visit strem.com .	1g 5g
93-1404	3-Chloropropyltrimethoxysilane, min. 97% (2530-87-2) (ClCH ₂ CH ₂ CH ₂)Si(OCH ₃) ₃ ; FW: 198.72; colorless liq.; b.p. 183°; f.p. 173°F; d. 1.077 <i>moisture sensitive</i>	50g 250g
14-1880	(1<i>R</i>,2<i>R</i>)-[1,2-Cyclohexanediamino-<i>N,N'</i>-bis(4-bromobenzyl)allylchlorosilane, min. 98% (546084-25-7) C ₂₃ H ₂₇ Br ₂ ClN ₂ Si; FW: 554.82; white solid <i>moisture sensitive, (store cold)</i> Note: Patent WO 3/074534, WO 06/062901.	250mg 1g

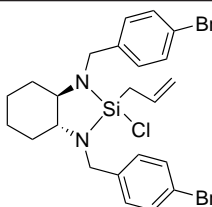
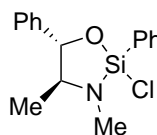
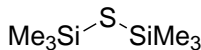
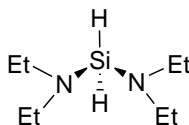

Technical Notes:

1. Reagent used in the enantioselective allylation of aldehydes.
2. Useful reagent for the enantioselective allylation of sterically hindered and functionalized ketones.

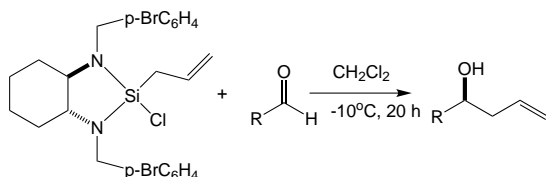

Tech. Note (1)
Ref. (1)

SILICON (Compounds)

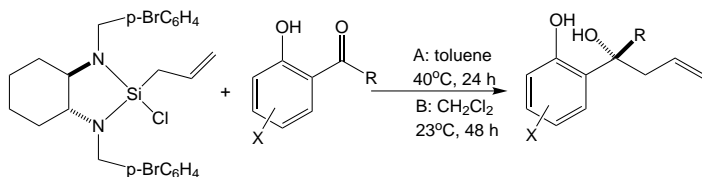

Tech. Note (2)
Ref. (2)

References:

1. *Angew. Chem. Int. Ed.*, **2003**, 42, 946
2. *Angew. Chem. Int. Ed.*, **2006**, 45, 3811

14-1950	Dimethylbis(indenyl)silane, min. 98% (136946-83-3) (C ₁₀ H ₈) ₂ Si(C ₉ H ₇) ₂ ; FW: 288.46; viscous yellow liq.	5g 25g
93-1493	Dimethyldichlorosilane, 99% (75-78-5) HAZ (CH ₃) ₂ SiCl ₂ ; FW: 129.07; colorless liq.; m.p. -76°; b.p. 70.5°; f.p. 3°F; d. 1.070 <i>moisture sensitive</i>	250g 1kg
93-1406	Dimethyldiethoxysilane, 97% (78-62-6) HAZ (CH ₃) ₂ Si(OC ₂ H ₅) ₂ ; FW: 148.30; colorless liq.; m.p. -70°; b.p. 114-115°; f.p. 53°F; d. 0.840 <i>moisture sensitive</i>	50g 250g
93-1497	Dimethylpolysilane (28883-63-8) [(CH ₃) ₂ Si-] _n ; FW: 1100-1700; off-white powdr.	10g 50g
14-1946	2,2-Dimethyl-4,7,10,13-tetraoxa-2-silatetradecane, 99+% Electrolyte Solvent ANL-1S1M3 (864079-63-0) C ₁₁ H ₂₆ O ₄ Si; FW: 250.41; colorless liq. <i>air sensitive, moisture sensitive</i> Note: Use for batteries for medical devices expressly excluded. U.S. Patent: 8,076,032 For detailed technical note visit strem.com .	1g 5g
14-1930	2,2-Dimethyl-3,6,9,12-tetroxa-2-silatridecane, 99+% Electrolyte Solvent ANL-1NM3 (864079-62-9) C ₁₀ H ₂₄ O ₄ Si; FW: 236.38; colorless liq. Note: Use for batteries for medical devices expressly excluded. U.S. Patent: 8,076,032 For detailed technical note visit strem.com .	1g 5g
14-1925	2,2-Dimethyl-3,6,9-trioxa-2-siladecane, 99+% Electrolyte Solvent ANL-1NM2 (62199-57-9) C ₈ H ₂₀ O ₃ Si; FW: 192.33; colorless liq. <i>air sensitive, moisture sensitive</i> Note: U.S. Patent: 8,475,688 For detailed technical note visit strem.com .	500mg 2g
93-1407	Diphenyldichlorosilane, min. 97% (80-10-4) HAZ (C ₆ H ₅) ₂ SiCl ₂ ; FW: 253.22; colorless liq.; m.p. -22°; b.p. 304°; f.p. 316°F; d. 1.204 <i>moisture sensitive</i>	50g 250g
14-2500	Diphenyldimethoxysilane, min. 97% (6843-66-9) (C ₆ H ₅) ₂ Si(OCH ₃) ₂ ; FW: 244.36; colorless liq.; b.p. 161°/15 mm; f.p. 250°F; d. 1.0771 <i>moisture sensitive</i>	50g 250g
93-1485	Diphenylsilane, min. 97% (775-12-2) (C ₆ H ₅) ₂ SiH ₂ ; FW: 184.30; colorless liq.; b.p. 95-97°/13 mm; f.p. 209°F; d. 1.00 <i>air sensitive, moisture sensitive</i>	5g 25g
93-1410	Diphenylsilanediol, min. 95% (947-42-2) HAZ (C ₆ H ₅) ₂ Si(OH) ₂ ; FW: 216.32; white powdr.; m.p. 140° dec.; f.p. 129°F <i>moisture sensitive</i>	25g 50g
15-1823	Diphenyl[3-(triethoxysilyl)propyl]phosphine, 98% (52090-23-0) See page 309	
93-1457	1,3-Divinyltetramethyldisiloxane, min. 97% (2627-95-4) HAZ [CH ₂ =CH(CH ₃) ₂ Si] ₂ O; FW: 186.40; colorless liq.; b.p. 139-140°; f.p. 76°F; d. 0.809 <i>moisture sensitive</i>	25g 100g

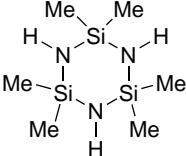
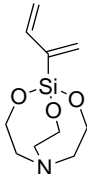
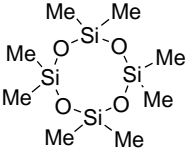

SILICON (Compounds)

93-1411 HAZ	Ethyltrichlorosilane, 98% (115-21-9) $C_2H_5SiCl_3$; FW: 163.52; colorless liq.; m.p. -105.6°; b.p. 98.8°; f.p. 14°F; d. 1.238 <i>moisture sensitive</i>	100g 500g
14-1955 NEW HAZ	Hexakis(ethylamino)disilane (99.995%-Si) PURATREM (532980-53-3) $(C_2H_5NH)_6Si_2$; FW: 320.63; colorless liq.; m.p. -7°; b.p. 257°; d. 1.0 <i>moisture sensitive</i>	1g 5g
14-1510 HAZ	2,2,4,4,6,6-Hexamethylcyclotrisilazane, 97% (1009-93-4) $C_6H_{21}N_3Si_3$; FW: 219.51; colorless liq.	 5g 25g
93-1494 HAZ	Hexamethyldisilane, 97% (1450-14-2) $(CH_3)_3SiSi(CH_3)_3$; FW: 146.40; colorless liq.; b.p. 112-113°; f.p. 29°F; d. 0.715	5g 25g
93-1413 HAZ	Hexamethyldisilazane, min. 97% (999-97-3) $(CH_3)_3SiNHSi(CH_3)_3$; FW: 161.40; colorless liq.; b.p. 126°; f.p. 48°F; d. 0.774 <i>moisture sensitive</i>	100g 500g
93-1486 HAZ	Methyldichlorosilane, min. 97% (75-54-7) CH_3SiCl_2H ; FW: 115.05; colorless liq.; m.p. -93°; b.p. 41.5°; f.p. -26°F; d. 1.110 <i>moisture sensitive</i>	250g 1kg
93-1415 HAZ	Methylphenyldichlorosilane, min. 97% (149-74-6) $(CH_3)(C_6H_5)SiCl_2$; FW: 191.11; colorless liq.; b.p. 205°; f.p. 181°F; d. 1.187 <i>moisture sensitive</i>	100g 500g
93-1416	Methylphenyldimethoxysilane, min. 97% (3027-21-2) $(CH_3)(C_6H_5)Si(OCH_3)_2$; FW: 182.30; colorless liq.; b.p. 199-200°; f.p. 177°F; d. 0.993 <i>moisture sensitive</i>	25g 100g
93-1418 HAZ	Methyltriethoxysilane, 98+% (2031-67-6) $CH_3Si(OC_2H_5)_3$; FW: 178.31; colorless liq.; b.p. 143°; f.p. 75°F; d. 0.896 <i>moisture sensitive</i>	100g 500g
93-1487 HAZ	Methyltrimethoxysilane, min. 95% (1185-55-3) $CH_3Si(OCH_3)_3$; FW: 136.23; colorless liq.; b.p. 102-103°; f.p. 52°F; d. 0.955 <i>moisture sensitive</i>	25g 100g
93-4216	12-Molybdosilic acid hydrate (11089-20-6) See page 138	
14-1960	2,2',2''-Nitrilotris(ethanolato)(buta-1,3-dien-2-yl)silane, min. 98% (1026785-83-0) $C_{10}H_{17}NO_3Si$; FW: 227.33; light yellow powd. <i>moisture sensitive</i> Note: Sold under license from Wake Forest University for research purposes only. PCT US2007/022872.	 250mg 1g
Technical Note: 1. Reagent used in Diels-Alder cross-coupling reactions.		
References: 1. <i>Org. Lett.</i> 2007 , <i>9</i> , 1623		
93-1469	Nonamethyltrisilazane, 98% (1586-73-8) $N[Si(CH_3)_3]_3$; FW: 233.60; white to colorless waxy solid; m.p. 70-71°; b.p. 76°/12 mm; d. 0.8635	5g 25g
14-5400 HAZ	Octamethylcyclotetrasiloxane, 98% (556-67-2) $C_8H_{20}O_4Si_4$; FW: 296.62; colorless liq.; m.p. 17-18°; b.p. 175-176°; d. 0.956 <i>moisture sensitive</i>	 25g 100g

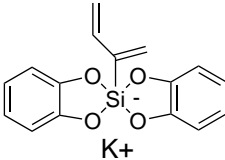
SILICON (Compounds)

93-1419 HAZ	Phenyltrichlorosilane, 97+% (98-13-5) C ₆ H ₅ SiCl ₃ ; FW: 211.55; colorless liq.; b.p. 201°; f.p. 196°F; d. 1.321 <i>moisture sensitive</i>	100g 500g
93-1488	Phenyltrimethoxysilane, 97% (2996-92-1) C ₆ H ₅ Si(OCH ₃) ₃ ; FW: 198.30; colorless liq.; b.p. 211°; f.p. 112°C; d. 1.064 <i>moisture sensitive</i>	50g 250g
14-1965	Potassium bis(1,2-benzenediolato)(1,3-butadien-2-yl)silicate, min. 98% (1021940-25-9) K ⁺ [C ₁₆ H ₁₃ O ₄ Si] ₂ ; FW: 336.46; white xtl. <i>moisture sensitive</i> Note: Sold under license from Wake Forest University for research purposes only. PCT US2007/022872.	250mg 1g
		
Technical Note:		
1. Reagent used in Diels-Alder cross-coupling reactions.		
References:		
1. <i>Org. Lett.</i> , 2007 , 9, 1623		
93-1427	Silica gel, 70-200 mesh (TLC) (63231-67-4) H ₂ SiO ₃ ; FW: 78.10; white powdr.; SA: ~835m ² /g	500g 2kg
93-1423	Silica gel, 6-16 mesh (indicating) (63231-67-4) H ₂ SiO ₃ ; FW: 78.10; blue xtl.	500g 2kg
93-1424	Silica gel, 12-24 mesh (liquid drying) (63231-67-4) H ₂ SiO ₃ ; FW: 78.10; white xtl.; SA: ~835m ² /g	500g 2kg
14-7400	Silica gel, large pore (63231-67-4) H ₂ SiO ₃ ; 8 mesh white gran.; SA: ~300m ² /g; P.Vol. ~1cc/g	250g 1kg
14-7420	Silica gel, large pore (63231-67-4) H ₂ SiO ₃ ; microspheroidal white powdr.; SA: ~300m ² /g; P.Vol. ~1.65cc/g	250g 1kg
14-6052	Silica Nanosprings™ coated with zinc oxide and grown on fiber glass substrate (3.5 x 8cm) (7631-86-9) See page 165	
93-1443 HAZ	Silicon(IV) acetate, min. 95% (562-90-3) Si(OOCC ₂ H ₅) ₄ ; FW: 264.27; white xtl.; m.p. 160° dec.; b.p. 148°/6 mm (110° subl.) <i>moisture sensitive, (store cold)</i>	25g 100g
93-1445 HAZ	Silicon(IV) bromide, 99+% (7789-66-4) SiBr ₄ ; FW: 347.72; colorless liq.; m.p. 5.4°; b.p. 154°; d. 2.772 <i>moisture sensitive</i>	5g 25g
14-1445 NEW HAZ	Silicon(IV) bromide, (99.99% Si) PURATREM (7789-66-4) SiBr ₄ ; FW: 347.72; colorless liq.; m.p. 5.4°; b.p. 154°; d. 2.772 <i>moisture sensitive</i>	5g 25g
93-1432	Silicon carbide, -100 mesh (409-21-2) SiC; FW: 40.10; light gray powdr.; m.p. 2700°; d. 3.22	500g 2kg
14-7126 NEW	Silicon carbide (alpha phase), 0.2-1.2 microns (99%-Si) (409-21-2) SiC; FW: 40.10; light-gray powdr.	100g 500g
14-7123 NEW	Silicon carbide (>90% beta phase), 0.2-5.0 microns (99+%-Si) (409-21-2) SiC; FW: 40.10; light-gray powdr.	50g 250g
14-7120 NEW	Silicon carbide (>90% beta phase), 0.1-1.2 microns (99%-Si) (409-21-2) SiC; FW: 40.10; gray powdr.	50g 250g
98-0147 HAZ	Silicon(IV) chloride, fiber optic grade (99.9999%-Si, 50ppm-Fe) PURATREM (10026-04-7) SiCl ₄ ; FW: 169.90; colorless liq.; m.p. -70°; b.p. 57.6°; d. 1.483 <i>moisture sensitive</i> Note: Available prepacked in ALD cylinder- see 98-4027.	100g 500g

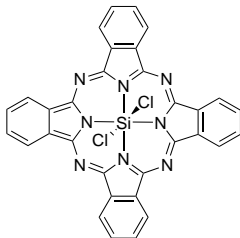
SILICON (Compounds)

98-4027 HAZ	Silicon(IV) chloride, fiber optic grade (99.9999%-Si, 50ppm-Fe) PURATREM, 98-0147, contained in a 50 ml electropolished Swagelok® cylinder (96-1077) for CVD/ALD (10026-04-7) SiCl ₄ ; FW: 169.90; colorless liq.; m.p. -70°; b.p. 57.6°; d. 1.483 <i>moisture sensitive</i>	50g
93-1447 HAZ	Silicon(IV) iodide (99.9%-Si) (13465-84-4) SiI ₄ ; FW: 535.70; off-white powdr.; m.p. 120.5°; b.p. 287.5°; d. 4.198 <i>moisture sensitive</i>	2g 10g
93-1442	Silicon(IV) nitride, < 5 micron (99%-Si) (12033-89-5) Si ₃ N ₄ ; FW: 140.28; light gray powdr.; m.p. 1900°; d. 3.44	50g 250g
14-7410 NEW	Silicon nitride (>90% alpha phase), 0.2-4.0 microns (99%-Si) (12033-89-5) Si ₃ N ₄ ; FW: 140.28; gray powdr.	100g 500g
14-7423 NEW	Silicon nitride, 0.2-2.5 microns (99.99%-Si) PURATREM (12033-89-5) Si ₃ N ₄ ; FW: 140.28; light gray powdr.	50g 250g
93-1478	Silicon(II) oxide, -325 mesh (99.9%-Si) (10097-28-6) SiO; FW: 44.09; brown powdr.; m.p. > 1702°; b.p. 1880°; d. 2.13	25g 100g
93-1477	Silicon(II) oxide, granular +10 mesh (99.9%-Si) (10097-28-6) SiO; FW: 44.09; brown powdr.; m.p. > 1702°; b.p. 1880°; d. 2.13	25g 100g
93-1436	Silicon(IV) oxide, 98% (7631-86-9) SiO ₂ ; FW: 60.09; white powdr. (3-10 microns); SA: 0.7m ² /g; m.p. 1500°; d. 2.6	250g 1kg
93-1434	Silicon(IV) oxide, 99+%, 0.012 micron (fumed colloidal silica) (112945-52-5) SiO ₂ ; FW: 60.09; white powdr.; SA: 200 m ² /g	100g 500g
98-0145	Silicon(IV) oxide, elec. gr. (99.999%-Si) PURATREM (7631-86-9) SiO ₂ ; FW: 60.09; white powdr.; m.p. 1500°; d. 2.6	5g 25g 100g
93-1435	Silicon(IV) oxide, -100 mesh, 99.7% (7631-86-9) SiO ₂ ; FW: 60.09; white powdr.; m.p. 1500°; d. 2.6	250g 1kg
14-2000	Silicon(IV) phthalocyanine dichloride, 85% (19333-10-9) (C ₃₂ H ₁₆ N ₈)SiCl ₂ ; FW: 611.53; purple powdr.; m.p. 430° subl.	1g 5g
		
11-1500	Sodium hexamethyldisilazane, min. 95% (1070-89-9) See page 419	
93-1451	Tetrabutoxysilane, min. 97% (4766-57-8) Si(OC ₄ H ₉) ₄ ; FW: 320.53; colorless liq.; b.p. 115°/3 mm; f.p. 174°F; d. 0.90 <i>moisture sensitive</i>	10g 50g
93-1452	Tetradecyloxysilane (18845-54-0) Si(OC ₁₀ H ₂₁) ₄ ; FW: 657.20; light orange liq.	25g 100g
93-1454 HAZ	Tetraethoxysilane, min. 98% TEOS (78-10-4) Si(OC ₂ H ₅) ₄ ; FW: 208.33; colorless liq.; m.p. -77°; b.p. 165.8°; f.p. 116°F; d. 0.934 <i>moisture sensitive</i>	500g 2kg
14-6990 NEW HAZ	Tetrakis(ethylmethylamino)silane, 98%, TEMAS (477284-75-6) [CH ₃ (CH ₂ CH ₂)N] ₄ Si; FW: 260.57; colorless liq.; b.p. 40°C; d. 0.89 <i>moisture sensitive</i>	1g 5g 25g
14-7000	Tetrakis(trimethylsilyl)silane, 98% TMSS (4098-98-0) Si[Si(CH ₃) ₃] ₄ ; FW: 320.85; off-white powdr.	1g
93-1459 HAZ 	Tetramethoxysilane, 98% (681-84-5) Si(OCH ₃) ₄ ; FW: 152.20; colorless liq.; m.p. 4-5°; b.p. 121-122°; f.p. 84°F; d. 1.032 <i>moisture sensitive</i>	25g 100g

SILICON (Compounds)

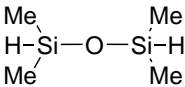
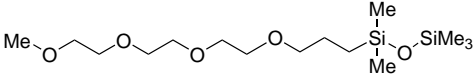
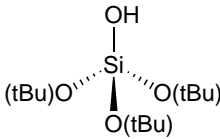
14-7025 NEW HAZ	1,1,3,3-Tetramethyldisiloxane, 99+% TMDSO (99.9999%-Si) PURATREM (3277-26-7) $C_4H_{14}OSi_2$; FW: 134.32; colorless liq.; b.p. 70-71°; f.p. -26°C; d. 0.76 <i>moisture sensitive</i>		25g 100g
14-1943 NEW	2,2,4,4-Tetramethyl-3,8,11,14,17-pentaoxa-2,4-disilaoctadecane, 99+% Electrolyte solvent ANL-2SM3 (855996-83-7) $C_{15}H_{36}O_5Si_2$; FW: 352.61; colorless liq. Note: Use for batteries for medical devices expressly excluded. U.S. Patent: 8,076,031 B1; 14/266,052. For detailed technical note visit strem.com .		5g 25g
93-1458 HAZ	Tetramethylsilane, 99.9+% (NMR grade) (75-76-3) $Si(CH_3)_4$; FW: 88.23; colorless liq.; b.p. 26.5°; f.p. -17°F; d. 0.651 (15°)		25g 100g
14-7028	Tri-t-butoxysilanol (99.9+% -Si) (18166-43-3) $[(CH_3)_3CO]_3SiOH$; FW: 264.43; colorless liq.; m.p. 63-65° <i>moisture sensitive</i> Note: Product sold under, use subject to, terms and conditions of label license at www.strem.com/harvard1 . For detailed technical note visit strem.com .		5g 25g
14-7015	Tri-t-butoxysilanol (99.999%-Si) PURATREM (18166-43-3) $[(CH_3)_3CO]_3SiOH$; FW: 264.43; white solid; m.p. 63-65° <i>moisture sensitive</i> Note: Product sold under, use subject to, terms and conditions of label license at www.strem.com/harvard1 . Available prepacked in ALD cylinder- see 98-6025.		1g 5g
98-6025	Tri-t-butoxysilanol (99.999%-Si) PURATREM 14-7015 contained in 50 ml Swagelok® cylinder (96-1077) for CVD/ALD (18166-43-3) $[(CH_3)_3CO]_3SiOH$; FW: 264.43; white solid <i>moisture sensitive</i> Note: Product sold under, use subject to, terms and conditions of label license at www.strem.com/harvard1 .		25g
93-1417 HAZ	Trichloromethylsilane, min. 97% (75-79-6) CH_3SiCl_3 ; FW: 149.50; colorless liq.; m.p. -77.8°; b.p. 66.4°; f.p. 5°F; d. 1.273 (25°) <i>moisture sensitive</i>		100g 500g
93-1463 amp HAZ	Triethylchlorosilane, 99% (994-30-9) $(C_2H_5)_3SiCl$; FW: 150.73; colorless liq.; b.p. 144°/735 mm; f.p. 85°F; d. 0.8967 (20°) <i>moisture sensitive</i>		5g 25g
14-7750 HAZ	Triethylsilane, 99% (617-86-7) $(C_2H_5)_3SiH$; FW: 116.28; colorless liq.; b.p. 107-108°; f.p. 25°F; d. 0.728 <i>air sensitive</i>		25g 100g
14-7850 HAZ	Triethylsilylacetylene, min. 97% (1777-03-3) $(C_2H_5)_3SiC\equiv CH$; FW: 140.30; colorless liq.; f.p. 63°F; d. 0.783		5g 25g
14-7910 HAZ	Triethylsilyl trifluoromethanesulfonate, 99% (79271-56-0) $CF_3SO_3Si(C_2H_5)_3$; FW: 264.34; colorless liq.; b.p. 85-86°/12mm; f.p. 161°F; d. 1.169 <i>moisture sensitive</i>		5g 25g
14-7990 HAZ	Trifluoromethyltrimethylsilane, min. 97% (81290-20-2) $CF_3Si(CH_3)_3$; FW: 142.20; colorless liq.; b.p. 45°; f.p. 14°F; d. 0.96 <i>moisture sensitive</i>		5g 25g
93-1464 HAZ	Trimethylchlorosilane, min. 97% (75-77-4) $(CH_3)_3SiCl$; FW: 108.65; colorless to pale yellow liq.; m.p. -40°; b.p. 57.3°; f.p. -18°F; d. 0.8536 (27°) <i>moisture sensitive</i>		100g 500g
93-1465 HAZ	Trimethylethoxysilane, min. 97% (1825-62-3) $(CH_3)_3SiOC_2H_5$; FW: 118.30; colorless liq.; b.p. 75-76°; f.p. -4°F; d. 0.757 <i>moisture sensitive</i>		25g 100g

SILICON (Compounds)

14-7925 HAZ	Trimethylsilane, 97% (993-07-7) (CH ₃) ₃ SiH; FW: 74.20; gas; m.p. -135.9°; b.p. 6.7°; f.p. <-4°F; d. 0.638 (6.7°)	100g
14-8200 HAZ	Trimethylsilylacetylene, min. 97% (1066-54-2) (CH ₃) ₃ SiC≡CH; FW: 98.22; colorless liq.; b.p. 53°; f.p. <-30°F; d. 0.709	5g 25g
14-8600 HAZ	Trimethylsilyl trifluoromethanesulfonate, min. 97% (27607-77-8) CF ₃ SO ₂ Si(CH ₃) ₃ ; FW: 222.26; colorless liq.; b.p. 77°/80 mm; f.p. 78°F; d. 1.150 <i>moisture sensitive</i>	5g 25g
14-7950 HAZ	Trimethylsilylcyclopentadiene, 97% (mixture of isomers) (3559-74-8) (C ₅ H ₅)Si(CH ₃) ₃ ; FW: 138.29; colorless liq.; b.p. 138-140°; f.p. 85°F; d. 0.833 <i>moisture sensitive, (store cold)</i>	1g 5g 25g
14-8000 HAZ	Trimethylsilylpentamethylcyclopentadiene (87778-95-8) [C ₅ (CH ₃) ₅]Si(CH ₃) ₃ ; FW: 208.42; light yellow liq.; b.p. 100°/10 mm; d. 0.833 <i>moisture sensitive, (store cold)</i>	1g 5g
14-7020	Tri-t-pentoxysilanol (99.999%-Si) PURATREM (17906-35-3) [CH ₃ CH ₂ C(CH ₃) ₂ O] ₃ SiOH; FW: 306.51; colorless liq. <i>moisture sensitive</i> Note: Product sold under, use subject to, terms and conditions of label license at www.strem.com/harvard1 . ***Limited quantities available.***	1g 5g
93-1466 HAZ	Triphenylchlorosilane, 97% (76-86-8) (C ₆ H ₅) ₃ SiCl; FW: 294.9; white xtl.; m.p. 91-92°; b.p. 378° <i>moisture sensitive</i>	10g 50g
93-1467	Triphenylsilane, min. 97% (789-25-3) (C ₆ H ₅) ₃ SiH; FW: 260.41; off-white powdr.; m.p. 43°; b.p. 152°/2 mm; f.p. 169°F <i>air sensitive, moisture sensitive</i>	10g 50g
93-1468	Triphenylsilanol, min. 98% (791-31-1) (C ₆ H ₅) ₃ SiOH; FW: 276.41; white powdr.; m.p. 153°	2g 10g
14-8750 HAZ	Tris(dimethylamino)silane, 99+% 3DMAS (15112-89-7) [(CH ₃) ₂ N] ₃ SiH; FW: 161.32; colorless to light yellow liq.; b.p. 145-148° (4°/16mm); f.p. 77°F; d. 0.84 Note: Available prepacked in ALD cylinder- see 98-4035.	5g 25g
98-4035 HAZ	Tris(dimethylamino)silane, 99+% 3DMAS, 14-8750, contained in 50 ml Swagelok® cylinder (96-1070) for CVD/ALD (15112-89-7) [(CH ₃) ₂ N] ₃ SiH; FW: 161.32; colorless to light yellow liq.; b.p. 145-148° (4°/16mm); f.p. 77°F; d. 0.84 <i>air sensitive, moisture sensitive</i>	25g
14-9000	Tris(trimethylsilyl)methane, min. 97% (1068-69-5) [(CH ₃) ₃ Si] ₃ CH; FW: 232.65; colorless liq.; b.p. 104°/20mm; f.p. 170°F; d. 0.827	1g 5g
14-9250 HAZ	Vinyltriacetoxysilane (4130-08-9) CH ₂ =CHSi(OOCCH ₃) ₃ ; FW: 232.27; colorless to pale yellow liq.; b.p. 115°/10 mm; d. 1.167 (20°) <i>air sensitive, moisture sensitive</i>	50g 250g
93-1492 HAZ	Vinyltrichlorosilane, min. 97% (75-94-5) CH ₂ =CHSiCl ₂ ; FW: 161.49; colorless liq.; b.p. 92°; f.p. 51°F; d. 1.243 (20°) <i>moisture sensitive</i>	50g 250g
93-1471 HAZ	Vinyltriethoxysilane, min. 97% (78-08-0) CH ₂ =CHSi(OC ₂ H ₅) ₃ ; FW: 190.32; colorless liq.; b.p. 161°; f.p. 94°F; d. 0.9050 (20°) <i>moisture sensitive</i>	100g 500g

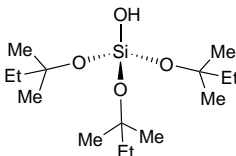
**SILVER (Elemental Forms)**

93-4760	Silver flake (99.9%) (7440-22-4) Ag; FW: 107.87; 100% < 20 micron; m.p. 960.5°; b.p. 2212°; d. 10.49	5g 25g
93-4761	Silver flake (99.9%) (7440-22-4) Ag; FW: 107.87; 90% < 3 micron; m.p. 960.5°; b.p. 2212°; d. 10.49	5g 25g
47-0050	Silver foil (99.9%) (7440-22-4) Ag; FW: 107.87; 1.0mm thick (~6.6g/25 x 25mm); m.p. 960.5°; b.p. 2212°; d. 10.49	25 x 25mm 50 x 50mm 100 x 100mm

SILVER (Elemental Forms)

47-0055	Silver foil (99.9%) (7440-22-4) Ag; FW: 107.87; 0.127mm thick (~3.3g/50 x 50mm); m.p. 960.5°; b.p. 2212°; d. 10.49	50 x 50mm 100 x 100mm 200 x 200mm
	Silver nanoparticles (0.02mg/ml in 2mM sodium citrate) (7440-22-4) See	
	Silver nanoparticles (0.02mg/ml in 2mM sodium citrate) reactant free (7440-22-4) See	
	Silver nanoparticles - surfactant and reactant-free (pure), manufactured via laser ablation (7440-22-4) See page 166	
47-0645	Silver Nano-Porous Catalyst (promoted with zirconium oxide) See page 166	
47-0058	Silver needles (99.999%) (7440-22-4) Ag; FW: 107.87; m.p. 960.5°; b.p. 2212°; d. 10.49	10g 50g 250g
47-2500	Silver on alumina (7440-22-4) Ag on Al ₂ O ₃ ; FW: 107.87; 2-4mm spheres	100g 500g
47-0060	Silver plate (99.95%) (7440-22-4) Ag; FW: 107.87; 3.175mm thick (~83.3g/5 x 5cm); m.p. 960.5°; b.p. 2212°; d. 10.49	5 x 5cm 10 x 10cm
93-4758	Silver powder (99.9%) (7440-22-4) HAZ Ag; FW: 107.87; 4-7 micron; SA: 0.1-0.4 m ² /g; m.p. 960.5°; b.p. 2212°; d. 10.49	5g 25g
93-4759	Silver powder (99.9%) (7440-22-4) HAZ Ag; FW: 107.87; -325 mesh; SA: 0.5-1.0 m ² /g; m.p. 960.5°; b.p. 2212°; d. 10.49	5g 25g
93-4755	Silver powder (99.95%) (7440-22-4) HAZ Ag; FW: 107.87; -100 mesh; m.p. 960.5°; b.p. 2212°; d. 10.49	25g 100g
93-4757	Silver powder (99.999+%) (7440-22-4) HAZ Ag; FW: 107.87; -22 mesh; m.p. 960.5°; b.p. 2212°; d. 10.49	5g 25g
47-0070	Silver rod (99.9%) (7440-22-4) Ag; FW: 107.87; 6.35mm dia. (~3.3g/cm); m.p. 960.5°; b.p. 2212°; d. 10.49	2cm 10cm
47-0080	Silver shot (99.9%) (7440-22-4) Ag; FW: 107.87; 1-5 mm; m.p. 960.5°; b.p. 2212°; d. 10.49	10g 50g
47-0085	Silver shot (99.99%) (7440-22-4) Ag; FW: 107.87; 1-3mm; m.p. 960.5°; b.p. 2212°; d. 10.49	10g 50g
93-4763	Silver shot (99.999%) (7440-22-4) Ag; FW: 107.87; 1-3 mm; m.p. 960.5°; b.p. 2212°; d. 10.49	10g 50g
47-0200	Silver wire (99.9%) (7440-22-4) Ag; FW: 107.87; 2.0 mm dia. (~33g/m); m.p. 960.5°; b.p. 2212°; d. 10.49	50cm 250cm
47-0250	Silver wire (99.9%) (7440-22-4) Ag; FW: 107.87; 1.0 mm dia. (~8.2g/m); m.p. 960.5°; b.p. 2212°; d. 10.49	1m 5m 25m
47-0300	Silver wire, annealed (99.9%) (7440-22-4) Ag; FW: 107.87; 0.5 mm dia. (~2g/m); m.p. 960.5°; b.p. 2212°; d. 10.49	2m 10m 50m
47-0350	Silver wire (99.9%) (7440-22-4) Ag; FW: 107.87; 0.25 mm dia. (~0.52g/m); m.p. 960.5°; b.p. 2212°; d. 10.49	25m 100m

SILVER (Compounds)

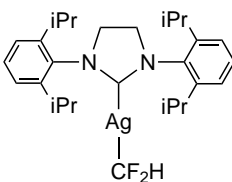
47-2575	[1,3-Bis[2,6-bis(i-propyl)phenyl]-2-imidazolidinylidene]difluoromethylsilver(I) C ₂₈ H ₄₀ AgF ₂ N ₂ ; FW: 550.50 <i>air sensitive</i>		100mg 500mg
93-4739	Potassium silver cyanide (99.9%-Ag) (506-61-6) See page 344		

SILVER (Compounds)

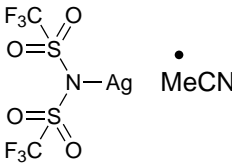
93-4701	Silver acetate, 99% (563-63-3) AgOOCCH ₃ ; FW: 166.92; off-white powdr.; m.p. dec. <i>light sensitive</i>	10g 50g
47-0650	Silver bis(trifluoromethanesulfonyl)imide acetonitrile adduct, min. 97% (189114-61-2) Ag[(N(CF ₃ SO ₂) ₂)]·CH ₃ CN; FW: 388.02; white to off-white solid	500mg 2g
		
93-4705	Silver bromide (99.9%-Ag) (7785-23-1) AgBr; FW: 187.78; yellow powdr.; m.p. 432°; d. 6.473 <i>light sensitive</i>	10g 50g
93-4706	Silver carbonate (99+%-Ag) (534-16-7) Ag ₂ CO ₃ ; FW: 275.75; yellow to pale green powdr.; m.p. 218°; d. 6.077 <i>light sensitive</i>	10g 50g
93-4707	Silver chloride (99.9%-Ag) (7783-90-6) AgCl; FW: 143.32; white powdr.; m.p. 455°; b.p. 1550°; d. 5.56 <i>light sensitive</i>	10g 50g
93-4745	Silver chromate, 99% (7784-01-2) HAZ Ag ₂ CrO ₄ ; FW: 331.73; brown xtl.; d. 5.625	10g 50g
93-4708	Silver cyanide, 99% (506-64-9) HAZ AgCN; FW: 133.84; white to off-white powdr.; m.p. 320° dec.; d. 3.95 <i>light sensitive</i>	10g 50g
93-4709	Silver cyclohexanebutyrate (AAS) (62638-04-4) Ag[OOC(CH ₂) ₃ C ₆ H ₁₁]; FW: 227.11; off-white powdr.	1g 5g
93-4741	Silver 2-ethylhexanoate, 99% (26077-31-6) AgOOCCH(C ₂ H ₅)C ₄ H ₉ ; FW: 251.08; white to off-white powdr. <i>light sensitive</i>	1g 5g
93-4746	Silver(I) fluoride, 98% (7775-41-9) HAZ AgF; FW: 126.87; yellow to brown solid; m.p. 435°; b.p. ~1159°; d. 5.852 <i>light sensitive, hygroscopic</i>	5g 25g
93-4747	Silver(II) fluoride, 98% (7783-95-1) HAZ AgF ₂ ; FW: 145.87; brown powdr.; m.p. 690°; b.p. 700° dec.; d. 4.58 <i>light sensitive, hygroscopic</i>	5g 25g
93-4748	Silver hexafluoroantimonate(V), 98% (26042-64-8) HAZ AgSbF ₆ ; FW: 343.61; white to off-white powdr. <i>hygroscopic</i>	1g 5g 25g
47-0900	Silver hexafluoroarsenate(V), 98.5% (12005-82-2) HAZ AgAsF ₆ ; FW: 296.78; off-white powdr.; m.p. dec. <i>hygroscopic</i>	2g 10g
47-1000	Silver hexafluorophosphate, 99% (26042-63-7) HAZ AgPF ₆ ; FW: 252.83; white xtl. <i>light sensitive, hygroscopic</i>	1g 5g 25g
93-4714	Silver iodide (99.9%-Ag) (7783-96-2) AgI; FW: 234.77; yellow powdr.; m.p. 558°; b.p. 1506°; d. 6.010 <i>light sensitive</i>	10g 50g
47-1050	Silver neodecanoate, min. 97% (68683-18-1) Ag(C ₁₀ H ₁₉ O ₂); FW: 279.13; white to off-white solid	1g 5g
93-4718	Silver nitrate (99.9%-Ag) (ACS) (7761-88-8) HAZ AgNO ₃ ; FW: 169.87; white xtl.; m.p. 212°; b.p. 444° dec.; d. 4.352	25g 100g 500g
47-1325	Silver nitrate (99.9995%-Ag) PURATREM (7761-88-8) HAZ AgNO ₃ ; FW: 169.87; white xtl.; m.p. 212°; b.p. 444° dec.; d. 4.352	10g 50g
93-4719	Silver nitrite, 99% (7783-99-5) HAZ AgNO ₂ ; FW: 153.88; off-white powdr.; m.p. 140° (dec.); d. 4.453	10g 50g
93-4743	Silver(I) oxide, 99+% (99.99%-Ag) PURATREM (20667-12-3) HAZ Ag ₂ O; FW: 231.74; black powdr.; m.p. 300° dec.; d. 7.143	10g 50g

SILVER (Compounds)

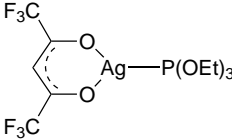
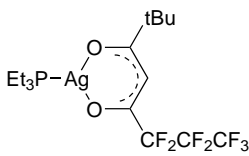
93-4742	Silver(II) oxide (99.9%-Ag) (1301-96-8)	10g
HAZ	AgO; FW: 123.87; black powdr.; m.p. > 100° dec.; d. 7.44	50g
93-4722	Silver perchlorate, anhydrous, min. 97% (7783-93-9)	5g
HAZ	AgClO ₄ ; FW: 207.32; white xtl.; m.p. 486° dec.; d. 2.806 <i>hygroscopic</i>	25g
93-4749	Silver perchlorate monohydrate, 99% (14242-05-8)	10g
HAZ	AgClO ₄ ·H ₂ O; FW: 207.32 (225.34); white xtl. <i>hygroscopic</i>	50g
47-1700	Silver perrhenate, 99% (99.995%-Re) PURATREM (20654-56-2)	1g
HAZ	AgReO ₄ ; FW: 358.07; white powdr.; m.p. 430°; d. 7.05	5g
93-4725	Silver phosphate, 99+% (7784-09-0)	10g
	Ag ₃ PO ₄ ; FW: 418.58; yellow powdr.; m.p. 849°; d. 6.37	50g
93-4731	Silver sulfate, 98+% (ACS) (10294-26-5)	10g
	Ag ₂ SO ₄ ; FW: 311.80; white powdr.; m.p. 652°; b.p. 1085° dec.; d. 5.45	50g
93-4733	Silver telluride (99.99%-Ag/Te) PURATREM (12002-99-2)	1g
	Ag ₂ Te; FW: 343.34; black xtl.; m.p. 955°; d. 8.5	5g
93-4734	Silver tetrafluoroborate, 99% (14104-20-2)	5g
HAZ	AgBF ₄ ; FW: 194.67; off-white powdr.; m.p. 200° dec. <i>light sensitive, hygroscopic</i> Note: Packaged in PFA/FET bottle.	25g
93-4735	Silver thiocyanate, 99% (1701-93-5)	5g
	AgSCN; FW: 165.95; white to off-white powdr.; m.p. dec.	25g
93-4736	Silver trifluoroacetate, min. 98% (2966-50-9)	5g
	AgOOCF ₃ ; FW: 220.88; white to off-white powdr.	25g
47-2000	Silver trifluoromethanesulfonate, 99% (Silver triflate) (2923-28-6)	5g
	AgSO ₃ CF ₃ ; FW: 256.94; off-white powdr. <i>light sensitive, hygroscopic</i> For detailed technical note visit strem.com .	25g 100g
47-2012	Silver trifluoromethanesulfonate (99.95%-Ag) (Silver triflate) (2923-28-6)	1g
NEW	AgSO ₃ CF ₃ ; FW: 256.94; off-white powdr. <i>light sensitive, hygroscopic</i> For detailed technical note visit strem.com .	5g 25g
93-4737	Silver tungstate, 99% (13465-93-5)	10g
	Ag ₂ WO ₄ ; FW: 463.59; white to off-white powdr.	50g
47-2600	2,2,6,6-Tetramethyl-3,5-heptanedionato silver(I) (99.9%-Ag) [Ag(TMHD)] (79827-25-1)	1g
	AgC ₁₁ H ₁₉ O ₂ ; FW: 291.14; gray powdr.; m.p. 178° dec.	5g 25g
47-3010	Triethoxyphosphine(trifluoroacetylacetonate) silver(I), min. 98% (783334-85-0)	1g
	Ag(CF ₃ COCHCOCH ₃)P(OCH ₂ CH ₃) ₃ ; FW: 427.10; yellow solid For detailed technical note visit strem.com .	5g
		
47-3025	Triethylphosphine(6,6,7,7,8,8,8-heptafluoro-2,2-dimethyl-3,5-octanedionato)silver(I), min. 98% (165461-74-5)	1g
	Ag(C ₃ F ₇ COCHCOC(C ₂ H ₅) ₃)P(CH ₂ CH ₃) ₃ ; FW: 521.20; yellow liq. to low melting solid; d. 1.623 <i>light sensitive, (store cold)</i> For detailed technical note visit strem.com .	5g
		
47-3000	Trimethylphosphine(hexafluoroacetylacetonato)silver(I), 99% (99.9%-Ag) (148630-66-4)	1g
	Ag(CF ₃ COCHCOCF ₃)P(CH ₃) ₃ ; FW: 391.00; white to yellow xtl.; m.p. 140-142°; b.p. subl. 95°/0.1mm	5g 25g
47-8000	Vinyltriethylsilane(hexafluoroacetylacetonato)silver(I) (99.9%-Ag) (177279-28-6)	1g
	Ag(CF ₃ COCHCOCF ₃)(C ₈ H ₁₈ Si); FW: 456.45; yellow liq. <i>air sensitive, (store cold)</i>	5g

Technical Note:

1. Precursor for the chemical vapor deposition of pure silver films.

SODIUM (Elemental Forms)

19-1910	Potassium sodium alloy 78:22 (99.95%) (11135-81-2) See page 340	
10-1020	Sodium (99.95%) (breakseal ampoule) (7440-23-5) Na; FW: 22.98; under argon; m.p. 97.8°; b.p. 892°; d. 0.97 HAZ <i>air sensitive, moisture sensitive</i>	1g 5g
93-1020	Sodium (99.95%) (prescored ampoule) (7440-23-5) Na; FW: 22.98; under argon; m.p. 97.8°; b.p. 892°; d. 0.97 HAZ <i>air sensitive, moisture sensitive</i>	1g 5g 25g 50g
93-1079	Sodium dispersion (7440-23-5) Na; FW: 22.98; gray suspension, 40% in mineral oil; m.p. 97.8°; b.p. 892°; d. 0.97 HAZ <i>air sensitive, moisture sensitive</i>	250g
93-1078	Sodium ingot (min. 99.8%) (7440-23-5) Na; FW: 22.98; under oil; m.p. 97.8°; b.p. 892°; d. 0.97 HAZ <i>air sensitive, moisture sensitive</i>	500g 5 x 500g
11-1020	Sodium potassium (K₂Na)-silica gel, 35-40% alkali metal in silica gel (Stage I) HAZ K ₂ Na/SiO ₂ ; black pwdr. <i>moisture sensitive</i>	5g 25g 100g
11-1005	Sodium-silica gel, 35-40% alkali metal in silica gel (Stage I) HAZ Na/SiO ₂ ; black pwdr.; 35-60 mesh <i>moisture sensitive</i> For detailed technical note visit strem.com .	5g 25g 100g

SODIUM (Compounds)

15-1142	2'-Dicyclohexylphosphino-2,6-dimethoxy-3-sulfonato-1,1'-biphenyl hydrate sodium salt (water soluble SPhos), min. 98% (1049726-96-6) See page 292	
15-1827	Diphenyl(m-sulfonatophenyl)phosphine dihydrate sodium salt, min. 90% (63995-75-5) See page 309	
93-1010	Perfluorooctanoic acid, sodium salt (335-95-5) See page 65	
93-1105	Sodium acetate, anhydrous, 99+% (ACS) (127-09-3) NaOOCCH ₃ ; FW: 82.03; white pwdr.; m.p. 324°; d. 1.528 <i>hygroscopic</i>	250g 1kg
93-1106	Sodium acetylacetonate hydrate, min. 98% (15435-71-9) Na(CH ₃ COCHCOCH ₃)·XH ₂ O; FW: 122.09; off-white pwdr.; m.p. 210° dec.	10g 50g
93-1021	Sodium acetylide (18% suspension in xylene) (1066-26-8) HAZ NaC≡CH; FW: 48.02; gray suspension; f.p. 85°F (xylene) <i>air sensitive, moisture sensitive</i>	50g 250g
93-1108	Sodium aluminate, contains ~8% H₂O (99.9%-Al) (1302-42-7) HAZ NaAlO ₂ ; FW: 81.97; white pwdr.; m.p. 1800° <i>hygroscopic</i>	500g 2kg
93-1112	Sodium azide, 98% (26628-22-8) HAZ NaN ₃ ; FW: 65.01; white pwdr.; m.p. 300° dec.; d. 1.846	100g 500g
93-1117	Sodium borodeuteride, 96 atom% D (15681-89-7) HAZ NaBD ₂ ; FW: 41.88; white pwdr.; m.p. ~400° dec.; d. 1.074 <i>moisture sensitive</i>	1g 5g
93-1118	Sodium borohydride, 98% (16940-66-2) HAZ NaBH ₄ ; FW: 37.83; white pwdr.; m.p. ~400° dec.; d. 1.074 <i>moisture sensitive</i>	50g 250g
93-1120	Sodium bromide, 99+% (ACS) (7647-15-6) NaBr; FW: 102.90; white xtl.; m.p. 755°; b.p. 1390°; d. 3.203 <i>hygroscopic</i>	500g 2kg
93-1121	Sodium bromide (99.999%-Na) PURATREM (7647-15-6) NaBr; FW: 102.90; white xtl.; m.p. 755°; b.p. 1390°; d. 3.203 <i>hygroscopic</i>	10g 50g

SODIUM (Compounds)

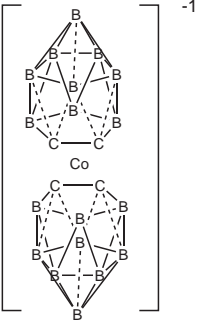
93-1022 HAZ	Sodium t-butoxide, min. 98% (865-48-5) C ₄ H ₉ ONa; FW: 96.11; white to off-white powdr. <i>moisture sensitive</i>	100g 500g
11-1000 HAZ	Sodium cacodylate trihydrate, 98% (6131-99-3) (CH ₃) ₂ As(O)ONa·3H ₂ O; FW: 159.91; white powdr.	25g 100g
93-1125	Sodium carbonate, anhydrous, 99.5+% (ACS) (497-19-8) Na ₂ CO ₃ ; FW: 105.99; white powdr.; m.p. 851°; d. 2.532 <i>hygroscopic</i>	500g 2kg
93-1126 HAZ	Sodium chlorate, 99% (7775-09-9) NaClO ₃ ; FW: 106.44; white powdr.; m.p. 248-261° dec.; d. 2.490	1kg 5 x 1kg
93-1128	Sodium chloride, 99+% (ACS) (7647-14-5) NaCl; FW: 58.44; white xtl.; m.p. 801°; b.p. 1413°; d. 2.165 <i>hygroscopic</i>	1kg 5kg
11-1100	Sodium chloride (99.999%-Na) PURATREM (7647-14-5) NaCl; FW: 58.44; white xtl.; m.p. 801°; b.p. 1413°; d. 2.165	10g 50g 250g
93-1129 HAZ	Sodium chromate tetrahydrate, 99+% (10034-82-9) Na ₂ CrO ₄ ·4H ₂ O; FW: 161.97 (234.07); yellow xtl.	100g 500g
05-2500	Sodium cobalticarborene (99492-72-5) NaCo(B ₃ C ₂ H ₁₁) ₂ ; FW: 346.74; yellow to orange powdr.	1g 5g 25g
		
93-1132 HAZ	Sodium cyanide, min. 98% (143-33-9) NaCN; FW: 49.01; white granules; m.p. 563.7°; b.p. 1496° <i>hygroscopic</i>	500g 2kg
11-2800 HAZ	Sodium cyanoborohydride, 95% (25895-60-7) NaBH ₃ CN; FW: 62.84; off-white powdr.; m.p. > 242° (dec.) <i>moisture sensitive</i>	5g 25g
93-1075 HAZ	Sodium cyclopentadienide, 2-3M in THF (4984-82-1) C ₅ H ₅ Na; FW: 88.09; yellow to red solution; f.p. 1°F (THF); d. 0.939 <i>air sensitive, moisture sensitive, (store cold)</i> Note: Free rubber septum included.	0.1mole 0.5mole
93-1077 HAZ	Sodium dihydrobis(2-methoxyethoxy)aluminate, 70% in toluene (22722-98-1) Na(CH ₃ OCH ₂ CH ₂ O) ₂ AlH ₂ ; FW: 202.16; colorless liq.; f.p. 40°F (toluene); d. 1.034 (20°) <i>air sensitive, moisture sensitive</i> Note: Free rubber septum included.	100g 500g
93-1174	Sodium dihydrogen phosphate monohydrate (99.9%-Na) (10049-21-5) NaH ₂ PO ₄ ·H ₂ O; FW: 120.05 (137.99); white powdr.	250g 1kg
11-2750	Sodium dioctylsulfosuccinate (AOT), min. 95% (577-11-7) See page 168	
11-1140	Sodium dodecylsulfate, 98+% (151-21-3) See page 168	
11-1285	Sodium dodecylsulfate, min. 99% (151-21-3) See page 168	

SODIUM (Compounds)

93-1139 HAZ	Sodium ethoxide, 96% (141-52-6) NaOC ₂ H ₅ ; FW: 68.05; white to yellow powdr. <i>moisture sensitive</i>	50g 250g
93-1163	Sodium 2-ethylhexanoate, min. 97% (19766-89-3) NaOOCCH(C ₂ H ₅)C ₄ H ₉ ; FW: 166.20; white powdr. <i>hygroscopic</i>	25g 100g
11-1230	Sodium 2-ethylhexanoate, 60% in water (19766-89-3) NaOOCCH(C ₂ H ₅)C ₄ H ₉ ; FW: 166.20; colorless liq.	50g 250g
93-1141 HAZ	Sodium fluoride, 99% (ACS) (7681-49-4) NaF; FW: 41.99; white powdr.; m.p. 988°; b.p. 1695°; d. 2.558	100g 500g
11-2000 HAZ	Sodium fluoride (99.99+% Na) PURATREM (7681-49-4) NaF; FW: 41.99; white powdr.; m.p. 988°; b.p. 1695°; d. 2.558	25g 100g
93-1059	Sodium fluorophosphate, 94% (10163-15-2) Na ₂ PO ₃ F; FW: 143.95; white powdr.; m.p. -625°	250g 1kg
77-8890	Sodium hexachloroiridate(IV) hexahydrate, 99% (19567-78-3) Na ₂ IrCl ₆ ·6H ₂ O; FW: 450.91 (559.01); red to black powdr.; m.p. 600° dec. <i>hygroscopic</i>	1g 5g
77-9000	Sodium hexachloroiridate(III) hydrate (123334-23-6) Na ₃ IrCl ₆ ·XH ₂ O; FW: 473.91; greenish-brown solid <i>hygroscopic</i>	1g 5g
93-7612	Sodium hexachloroosmate(IV) hydrate (1307-81-9) Na ₂ OsCl ₆ ·XH ₂ O; FW: 448.90; brown to black powdr. <i>hygroscopic</i>	500mg 2g
76-3520	Sodium hexachloroosmate(IV) hydrate (99.98+% Os) (1307-81-9) Na ₂ OsCl ₆ ·XH ₂ O; FW: 448.90; brown to black powdr. <i>hygroscopic</i>	500mg 2g
93-4612	Sodium hexachloropalladate(IV), 98+% (53823-60-2) Na ₂ PdCl ₆ ; FW: 365.10; orange to red xtl. <i>hygroscopic</i>	1g 5g
78-1995	Sodium hexachloroplatinate(IV) hexahydrate, 98+% (19583-77-8) Na ₂ PtCl ₆ ·6H ₂ O; FW: 453.79 (561.89); orange powdr. <i>hygroscopic</i>	1g 5g
45-2000	Sodium hexachlororhodate(III) hydrate (14972-70-4) Na ₃ RhCl ₆ ·XH ₂ O; FW: 384.59; red xtl. <i>hygroscopic</i>	250mg 1g 5g
93-1140	Sodium hexacyanoferrate(II) decahydrate (14434-22-1) Na ₄ Fe(CN) ₆ ·10H ₂ O; FW: 303.88 (484.04); pale yellow xtl.; d. 1.458	500g 2kg
11-1450	Sodium hexafluoroacetylacetonate, 97% (22466-49-5) Na(CF ₃ COCHCOCF ₃); FW: 230.04; white powdr. <i>hygroscopic</i>	1g 5g 25g
93-1399 HAZ	Sodium hexafluoroaluminate (99.9+% Al) (13775-53-6) Na ₃ AlF ₆ ; FW: 209.95; white powdr.; m.p. 1000°; d. 2.90	2g 10g
93-1006	Sodium hexafluoroantimonate(V), 99% (16925-25-0) NaSbF ₆ ; FW: 258.73; white powdr.; d. 3.375	25g 100g
93-1145	Sodium hexafluoroarsenate(V), 99% (12005-86-6) NaAsF ₆ ; FW: 211.90; white powdr.	5g 25g
93-1146	Sodium hexafluorophosphate, 99% (21324-39-0) NaPF ₆ ; FW: 167.95; white xtl.; d. 3.375 <i>hygroscopic</i>	10g 50g
11-1146 NEW	Sodium hexafluorophosphate 99% (99.99%-Na) PURATREM (21324-39-0) F ₆ NaP; FW: 167.95; white powdr.; d. 2.37 <i>air sensitive, moisture sensitive, hygroscopic</i>	2g 10g
93-1147 HAZ	Sodium hexafluorosilicate, 99% (16893-85-9) Na ₂ SiF ₆ ; FW: 188.05; white powdr.; m.p. dec.; d. 2.679	100g 500g
93-1148	Sodium hexafluorostannate(IV), 99% (16924-51-9) Na ₂ SnF ₆ ; FW: 278.66; white powdr.	5g 25g

SODIUM (Compounds)

93-1007	Sodium hexafluorotitanate(IV), 98% (17116-13-1) Na ₂ TiF ₆ ; FW: 207.87; white powdr.	10g 50g
11-1500 HAZ	Sodium hexamethyldisilazane, min. 95% (1070-89-9) [(CH ₃) ₂ Si] ₂ NNa; FW: 183.38; off-white powdr. <i>moisture sensitive</i>	5g 25g
93-1056	Sodium hexanitritocobaltate(III), (ACS) (13600-98-1) Na ₃ Co(NO ₂) ₆ ; FW: 403.98; orange powdr.	50g 250g
93-1151 HAZ	Sodium hydride, 60% in oil (7646-69-7) NaH; FW: 24.00; gray powdr. <i>air sensitive, moisture sensitive</i>	250g 1kg
93-1053	Sodium hydrogen carbonate, 99.7+% (ACS) (144-55-8) NaHCO ₃ ; FW: 84.01; white powdr.	500g 2kg
93-1173	Sodium hydrogen phosphate, 99+% (ACS) (7558-79-4) Na ₂ HPO ₄ ; FW: 141.96; white powdr.; d. 1.679	500g 2kg
93-1061 HAZ	Sodium hydrogen sulfide, anhydrous (16721-80-5) NaHS; FW: 56.06; off-white powdr.; m.p. 350° <i>hygroscopic</i>	1g 5g 25g
93-1064 HAZ	Sodium hydroxide monohydrate (99.996%-Na) PURATREM (12179-02-1) NaOH·H ₂ O; FW: 40.00 (58.01); white xtl. <i>hygroscopic</i>	10g 50g
93-1063 HAZ	Sodium hydroxide, pellets, 97+% (ACS) (1310-73-2) NaOH; FW: 40.00; white pellets; m.p. 318.4°; b.p. 1390°; d. 2.130 <i>hygroscopic</i>	500g 2kg
93-1156	Sodium iodide, anhydrous, 99% (H₂O < 1%) (7681-82-5) NaI; FW: 149.89; white powdr.; m.p. 651°; b.p. 1304°; d. 3.667 <i>hygroscopic</i>	100g 500g
93-1196 HAZ	Sodium metasilicate, anhydrous, min. 95% (6834-92-0) Na ₂ SiO ₃ ; FW: 122.06; white powdr.; m.p. 1088°; d. 2.4 <i>hygroscopic</i>	500g 2kg
93-1448 HAZ	Sodium metasilicate pentahydrate, 99% (6834-92-0) Na ₂ SiO ₃ ·5H ₂ O; FW: 122.06 (212.14); white powdr.; m.p. 40-48°	500g 2kg
93-2303 HAZ	Sodium metavanadate, min. 96% (13718-26-8) NaVO ₃ ; FW: 121.93; white powdr.; m.p. 630°	100g 500g
93-1159 HAZ	Sodium methoxide, 98+% (124-41-4) NaOCH ₃ ; FW: 54.02; white powdr. <i>moisture sensitive</i>	500g 1kg
93-1160	Sodium molybdate, anhydrous, 98+% (7631-95-0) Na ₂ MoO ₄ ; FW: 205.92; white to off-white powdr.; m.p. 687°; d. 3.28	100g 500g
93-4234	Sodium molybdate dihydrate, 99% (10102-40-6) Na ₂ MoO ₄ ·2H ₂ O; FW: 205.92 (241.95); white powdr.; d. 3.28	100g 500g
42-4234	Sodium molybdate dihydrate, 99.5% (ACS) (10102-40-6) Na ₂ MoO ₄ ·2H ₂ O; FW: 205.92 (241.95); white powdr.; d. 3.28	100g 500g
93-1057	Sodium niobate (99.9%-Nb) (12034-09-2) NaNbO ₃ ; FW: 163.89; white powdr.	5g 25g
93-1161 HAZ	Sodium nitrate, 99+% (ACS) (7631-99-4) NaNO ₃ ; FW: 84.99; white xtl.; m.p. 306.8°; d. 2.261 <i>hygroscopic</i>	500g 2kg
93-1162 HAZ	Sodium nitrite, 97+% (ACS) (7632-00-0) NaNO ₂ ; FW: 69.00; white powdr.; m.p. 271°; b.p. 320° dec.; d. 2.168 <i>hygroscopic</i>	500g 2kg
11-1280	Sodium oleate, 99% (143-19-1) <i>See page 169</i>	
93-1449 HAZ	Sodium orthosilicate (13472-30-5) Na ₄ SiO ₄ ; FW: 184.04; white powdr.; m.p. 1018°	1kg 5kg
93-1165 HAZ	Sodium oxalate, 99+% (62-76-0) Na ₂ C ₂ O ₄ ; FW: 134.00; white powdr.	100g 500g

SODIUM (Compounds)

11-1007 HAZ	Sodium oxide/sodium on alumina, Olefin Isomerization Catalyst (Na ₂ O 11.5-13.5%, Na 1.8-3.0%) Na ₂ O/Na; white solid <i>moisture sensitive</i>	10g 50g
----------------	---	------------

Catalyst benefits:

- Very active and highly selective olefin isomerization catalyst
- Highly resistant to catalyst poisons (tetrahydroindene, cyclopentadiene, etc.)

Uses:

- Diene monomer in the production of EPDM rubber.
- Scent carrier for flavors and fragrances.

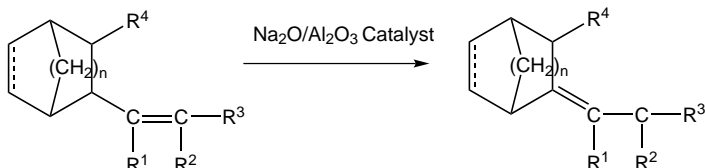

93-1169 HAZ	Sodium perchlorate, anhydrous, 98% (ACS) (7601-89-0) NaClO ₄ ; FW: 122.44; white powdr.; m.p. 482° dec.; d. 2.02 <i>hygroscopic</i>	100g 500g
93-1170 HAZ	Sodium perchlorate monohydrate, 98% (7791-07-3) NaClO ₄ ·H ₂ O; FW: 122.44 (140.48); white powdr.; m.p. 130°; d. 2.02 <i>hygroscopic</i>	100g 500g
93-1050 HAZ	Sodium peroxide, min. 93% (ACS) (1313-60-6) Na ₂ O ₂ ; FW: 77.98; yellow powdr.; m.p. 460° dec.; d. 2.805 <i>moisture sensitive</i>	50g 250g
93-7508 HAZ	Sodium perrhenate (99.9%-Re) (13472-33-8) NaReO ₄ ; FW: 273.19; white powdr.; m.p. 300° (in O ₂); d. 5.39 <i>hygroscopic</i>	1g 5g
93-1175	Sodium phosphate dodecahydrate, 98+% (ACS) (10101-89-0) Na ₃ PO ₄ ·12H ₂ O; FW: 163.94 (380.12); white powdr.	250g 1kg
93-1176	Sodium phthalocyanine (25476-27-1) (C ₃₂ H ₁₆ N ₈)Na ₂ ; FW: 558.51; purple powdr.	5g

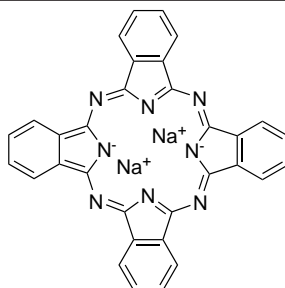

93-3414 HAZ	Sodium selenite, 99% (10102-18-8) Na ₂ SeO ₃ ; FW: 172.94; white powdr.	50g 250g
93-1179	Sodium stannate trihydrate, min. 95% (12209-98-2) Na ₂ SnO ₃ ·3H ₂ O; FW: 212.68 (266.71); white powdr.	100g 500g
93-1180	Sodium stearate, tech. gr. (822-16-2) Na(OOCC ₁₇ H ₃₅); FW: 306.49; white powdr.	1kg
93-1068	Sodium sulfate, anhydrous, 99+% (ACS) (7757-82-6) Na ₂ SO ₄ ; FW: 142.04; white powdr.; m.p. 888°; d. 2.68	250g 1kg 5kg
93-1069	Sodium sulfate, anhydrous (99.999%-Na) PURATREM (7757-82-6) Na ₂ SO ₄ ; FW: 142.04; white powdr.; m.p. 888°; d. 2.68	10g 50g
93-1182 HAZ	Sodium sulfide, anhydrous, min. 95% (1313-82-2) Na ₂ S; FW: 78.04; off-white powdr.; m.p. 950°; d. 1.856 <i>hygroscopic</i>	5g 25g

SODIUM (Compounds)

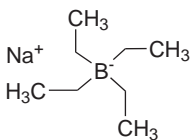
93-1183 HAZ	Sodium sulfide nonahydrate, 98+% (ACS) (1313-84-4) Na ₂ S·9H ₂ O; FW: 78.04 (240.18); colorless to pale yellow solid (store cold)	100g 500g
93-1184	Sodium sulfite, anhydrous, 98+% (ACS) (7757-83-7) Na ₂ SO ₃ ; FW: 126.04; white powdr.; m.p. dec.; d. 2.633	250g 1kg
93-1186	Sodium tellurate(VI) dihydrate, 99.5% (26006-71-3) Na ₂ TeO ₄ ·2H ₂ O; FW: 237.58 (273.61); white powdr.	5g 25g
93-1188	Sodium tetraborate, anhydrous, 99+% (1330-43-4) Na ₂ B ₄ O ₇ ; FW: 201.22; white powdr.; m.p. 741°; b.p. 1575° dec.; d. 2.367	500g 2kg
93-1072	Sodium tetraborate, anhydrous (99.998%-B) (50 ppm K) PURATREM (1330-43-4) Na ₂ B ₄ O ₇ ; FW: 201.22; white powdr.; m.p. 741°; b.p. 1575° dec.; d. 2.367	10g 50g
93-1070	Sodium tetraborate decahydrate, 99.5+% (ACS) (1303-96-4) Na ₂ B ₄ O ₇ ·10H ₂ O; FW: 201.22 (381.37); white xtl.; m.p. 75° dec.; d. 1.73	500g 2kg
79-3505	Sodium tetrabromoaurate(III) hydrate (99.9+% -Au) (52495-41-7) NaAuBr ₄ ·XH ₂ O; FW: 539.59; red to black xtl.	1g 5g
93-4613	Sodium tetrachloropalladate(II) trihydrate, 99% (13820-53-6) Na ₂ PdCl ₄ ·3H ₂ O; FW: 294.19 (348.22); reddish-brown powdr.	2g 10g
93-7810	Sodium tetrachloroplatinate(II) hydrate (207683-21-4) Na ₂ PtCl ₄ ·XH ₂ O; FW: 382.92; reddish-brown powdr.; m.p. 100°	1g 5g
11-0575 amp HAZ 	Sodium tetraethylborate, min. 98% (15523-24-7) NaB(C ₂ H ₅) ₄ ; FW: 150.04; white powdr.; m.p. dec. <i>moisture sensitive, pyrophoric</i>	1g 5g 25g
		
93-1189 HAZ	Sodium tetrafluoroborate, 98% (13755-29-8) NaBF ₄ ; FW: 109.79; white powdr.; m.p. 384° dec.; d. 2.47	500g 2kg
11-0590	Sodium tetrakis[3,5-bis(trifluoromethyl)phenyl]borate, min. 98% NaBARF (79060-88-1) Na+[B(C ₆ H ₃ (CF ₃) ₂) ₄] ⁻ ; FW: 886.20; tan powdr. Note: Can contain <5 mole% water and <5 mole% residual ethers.	50mg 250mg 1g
11-1015	Sodium tetrakis(4-fluorophenyl)borate dihydrate, 97% (207683-22-5) C ₂₄ H ₂₀ BF ₄ NaO ₂ ; FW: 414.18(450.21); white xtl.	250mg 1g 5g
11-1015 NEW	Sodium tetrakis(4-fluorophenyl)borate dihydrate, 97% (207683-22-5) C ₂₄ H ₂₀ BF ₄ NaO ₂ ; FW: 414.18(450.21); white xtl.	250mg 1g 5g
93-0571	Sodium tetraphenylborate, 99.5+% (ACS) (143-66-8) NaB(C ₆ H ₅) ₄ ; FW: 342.23; white powdr.	5g 25g 100g
11-0600	Sodium tetraphenylborate, tech. gr. (min. 95%) (143-66-8) NaB(C ₆ H ₅) ₄ ; FW: 342.23; off-white to pink powdr.	25g 100g
93-1197	Sodium titanate, 95% (12034-36-5) Na ₂ Ti ₃ O ₇ ; FW: 301.68; yellow powdr.; m.p. 1128°; d. 3.35-3.50	100g 500g
11-0595 HAZ	Sodium triacetoxymethylborohydride, min. 95% (56553-60-7) Na(OOCCH ₃) ₃ BH; FW: 211.94; white powdr.; m.p. 106° <i>air sensitive, moisture sensitive, (store cold)</i>	25g 100g
93-1194	Sodium trifluoroacetate, 97+% (2923-18-4) NaOOCF ₃ ; FW: 136.01; white powdr.; m.p. 207-209°	10g 50g
11-0560	Sodium trifluoromethanesulfonimide, min. 97% (91742-21-1) Na(C ₂ F ₆ NO ₄ S ₂); FW: 303.14; white powdr. <i>hygroscopic</i>	250mg 1g 5g
93-1195	Sodium tripolyphosphate, tech. gr., min. 85% (7758-29-4) Na ₅ P ₃ O ₁₀ ; FW: 367.86; white powdr.	500g 2kg
93-7422	Sodium tungstate dihydrate, 99+% (ACS) (10213-10-2) Na ₂ WO ₄ ·2H ₂ O; FW: 293.83 (329.86); white xtl.; m.p. 692°; d. 3.24	100g 500g

SODIUM (Compounds)

11-2700	Sodium(cyclopentadienyl)tris(dimethylphosphito)cobaltate(I), 98% (82149-18-6) Na(C ₅ H ₅)Co[PO(OCH ₃) ₂] ₃ ; FW: 474.14; yellow to orange xtl.	1g 5g
11-1200 amp HAZ	Sodium-i-propylcyclopentadienide (65090-77-9) (C ₃ H ₇)C ₅ H ₄ Na; FW: 130.17; white to off-white xtl. <i>air sensitive, moisture sensitive</i>	5g 25g

STRONTIUM (Elemental Forms)

93-3831 HAZ	Strontium pieces (99%) (7440-24-6) Sr; FW: 87.63; 20-30mm (packed in mineral oil); m.p. 769°; b.p. 1384°; d. 2.54 <i>air sensitive, moisture sensitive</i>	25g 100g
38-0074 amp HAZ	Strontium pieces, dendritic (99.9%) (7440-24-6) Sr; FW: 87.63; ampouled under argon; m.p. 769°; b.p. 1384°; d. 2.54 <i>air sensitive, moisture sensitive</i>	25g

STRONTIUM (Compounds)

38-8400	Bis(6,6,7,7,8,8,8-heptafluoro-2,2-dimethyl-3, 5-octanedionate)strontium hydrate [Sr(FOD)₂] (36885-30-0) Sr(C ₇ F ₇ COCHCOC(CH ₃) ₂) ₂ ·XH ₂ O; FW: 678.00; white powder; b.p. dec. 230° (subl. 100°/0.1mm)	1g 5g 25g
38-1000	Bis(2,2,6,6-tetramethyl-3,5-heptanedionato)strontium hydrate [Sr(TMHD)₂] (199445-30-2) Sr(C ₁₁ H ₁₉ O ₂) ₂ ·XH ₂ O; FW: 454.16; light yellow powder; m.p. 200-203°; b.p. dec. 250° (subl. 230°/0.05mm)	1g 5g 25g
38-1010	Bis(2,2,6,6-tetramethyl-3,5-heptanedionato)strontium tetraglyme adduct (99.99%-Sr) PURATREM (150939-76-7) Sr(C ₁₁ H ₁₉ O ₂) ₂ ·CH ₃ (OCH ₂ CH ₂) ₄ OCH ₃ ; FW: 454.16 (676.44); white xtl.; m.p. 75° Note: This compound is covered by U.S. Patent No. 5,225,561, and is manufactured and sold under license from Advanced Technology Materials, Inc., Danbury, CT.	1g 5g
38-1015	Bis(2,2,6,6-tetramethyl-3,5-heptanedionato)strontium triglyme adduct (99.99%-Sr) PURATREM Sr(C ₁₁ H ₁₉ O ₂) ₂ ·CH ₃ (OCH ₂ CH ₂) ₃ OCH ₃ ; FW: 454.16 (632.39); white xtl.; m.p. 102° Note: This compound is covered by U.S. Patent No. 5,225,561, and is manufactured and sold under license from Advanced Technology Materials, Inc., Danbury, CT.	1g 5g
93-3801	Strontium acetate, reagent (543-94-2) Sr(OOCCCH ₃) ₂ ; FW: 205.71; white powder; d. 2.099	100g 500g
93-3847	Strontium acetylacetonate hydrate, 99% (12193-47-4) Sr(CH ₃ COCHCOC(CH ₃) ₂) ₂ ·XH ₂ O; FW: 285.84; white powder; m.p. 220° dec.	25g 100g
38-3838	Strontium bis(N,N,N',N',N"-pentamethyldiethylenetriamine)bis[BREW] (99.99+%-Sr) PURATREM Sr(C ₉ H ₂₃ N ₃) ₂ [C·HyC(O)CHC(O)C·Hy] ₂ (x=3-4, y=2x+1); pale yellow liq. <i>moisture sensitive</i> Note: 9-11 wt% Sr, ***Limited quantities available. Will discontinue when stock is gone***	1g 5g
Technical Note: 1. See 56-5656 (page 11)		
93-3802	Strontium bromide, anhydrous, 99% (10476-81-0) SrBr ₂ ; FW: 247.44; white powder; m.p. 643°; d. 4.216 <i>hygroscopic</i>	25g 100g
93-3804	Strontium carbonate, min. 97% (contains ~1.0-2.5% barium carbonate) (1633-05-2) SrCO ₃ ; FW: 147.63; white powder; m.p. 1497°; d. 3.70	250g 1kg
93-3803	Strontium carbonate (low alkali and heavy metals) (99.9%-Sr) (1633-05-2) SrCO ₃ ; FW: 147.63; white powder; m.p. 1497°; d. 3.70	50g 250g
38-1100	Strontium carbonate (99.995%-Sr) PURATREM (1633-05-2) SrCO ₃ ; FW: 147.63; white powder; m.p. 1497°; d. 3.70	10g 50g
93-3806	Strontium chloride, anhydrous, min. 95% (10476-85-4) SrCl ₂ ; FW: 158.53; white powder; m.p. 873°; b.p. 1250°; d. 3.052 <i>hygroscopic</i>	250g 1kg

STRONTIUM (Compounds)

93-3807	Strontium chloride hexahydrate, 99% (ACS) (10025-70-4) SrCl ₂ ·6H ₂ O; FW: 158.53 (266.62); white xtl.; m.p. 115°; d. 1.93	100g 500g
38-2400	Strontium 2-ethylhexanoate, ~40% in 2-ethylhexanoic acid (8-12% Sr) (2457-02-5) Sr[OOCCH(C ₂ H ₅)C ₄ H ₉] ₂ ; FW: 374.04; viscous liq.	25g 100g
93-3808	Strontium fluoride, reagent, 99% (7783-48-4) SrF ₂ ; FW: 125.62; white powdr.; m.p. > 1450°; b.p. 2489°; d. 4.24 <i>hygroscopic</i>	100g 500g
93-3843	Strontium fluoride (99.99%-Sr) PURATREM (7783-48-4) SrF ₂ ; FW: 125.62; white powdr.; m.p. > 1450°; b.p. 2489°; d. 4.24 <i>hygroscopic</i>	10g 50g
38-2000	Strontium hexafluoroacetylacetonate (1245785-21-0) Sr(CF ₃ COCHCOCF ₃) ₂ ; FW: 501.75; off-white powdr.; m.p. dec. 260°; b.p. (subl. 220°/0.02mm)	1g 5g 25g
38-3840 HAZ	Strontium hydride (99.5%-Sr) (13598-33-9) SrH ₂ ; FW: 89.64; -60 mesh gray powdr. <i>moisture sensitive</i>	1g 5g
93-3810	Strontium hydroxide octahydrate, tech. gr. (1311-10-0) Sr(OH) ₂ ·8H ₂ O; FW: 121.63 (265.76); white xtl.; d. 1.90 <i>hygroscopic</i>	500g 2kg
38-7000	Strontium neodecanoate, superconductor grade (16-21% Sr) (106705-37-7) Sr(OOCC ₉ H ₁₉ -neo) ₂ ; FW: 430.10; off-white powdr.	10g 50g
93-3814 HAZ	Strontium nitrate, 98+% (10042-76-9) Sr(NO ₃) ₂ ; FW: 211.63; white xtl.; m.p. 570°; d. 2.990 <i>hygroscopic</i>	100g 500g
38-2100 HAZ	Strontium nitrate, 99+% (ACS) (10042-76-9) Sr(NO ₃) ₂ ; FW: 211.63; white xtl.; m.p. 570°; d. 2.990 <i>hygroscopic</i>	25g 250g 1kg
38-3860 HAZ	Strontium nitride (99.5%-Sr) (12033-82-8) Sr ₃ N ₂ ; FW: 290.87; -60 mesh tan powdr. <i>moisture sensitive</i>	1g 5g
93-3815	Strontium oxalate, min. 95% (814-95-9) SrC ₂ O ₄ ; FW: 175.64; white powdr.	100g 500g
38-2250	Strontium oxide (99.9%-Sr) (1314-11-0) SrO; FW: 103.62; white powdr.; m.p. 2430°; d. 4.7 <i>moisture sensitive</i>	10g 50g
93-3817 HAZ	Strontium perchlorate hydrate (99.9%-Sr) (13450-97-0) Sr(ClO ₄) ₂ ·xH ₂ O; FW: 286.52; white xtl.; m.p. < 100° <i>hygroscopic</i>	100g 500g
38-2500 HAZ	Strontium i-propoxide, min. 95% (88863-33-6) Sr(OC ₃ H ₇) ₂ ; FW: 205.80; off-white powdr. <i>moisture sensitive</i>	5g 25g
93-3821	Strontium sulfide (99.9%-Sr) (1314-96-1) SrS; FW: 119.68; -200 mesh powdr.; m.p. > 2000°; d. 3.70 <i>air sensitive, moisture sensitive</i>	10g 50g
93-3823	Strontium titanate, 99+% (12060-59-2) SrTiO ₃ ; FW: 183.51; white to off-white powdr.	250g 1kg
93-3826	Strontium zirconate, 95% (12036-39-4) SrZrO ₃ ; FW: 226.84; white powdr.	250g 1kg

SULFUR (Elemental Forms)

93-1616 HAZ	Sulfur (99.999%) (7704-34-9) S; FW: 32.06; 6mm pieces and down; m.p. 112.8°; b.p. 444.67°; d. 2.07	25g 100g 500g
93-1617 HAZ	Sulfur powder, precipitated, purified (7704-34-9) S; FW: 32.06; -60 mesh powdr.; m.p. 112.8°; b.p. 444.67°; f.p. 405°F; d. 2.07	250g 1kg
93-1618 HAZ	Sulfur powder, sublimed (99+% (7704-34-9) S; FW: 32.06; -100 mesh powdr.; m.p. 112.8°; b.p. 444.67°; f.p. 405°F; d. 2.07	250g 1kg

SULFUR (Compounds)

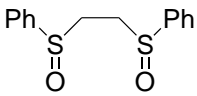
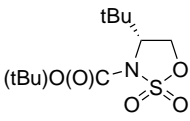
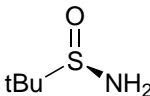
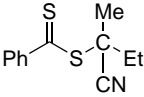
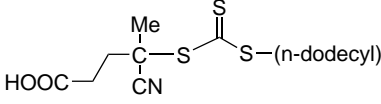
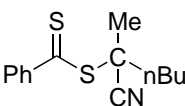
16-0350	1,2-Bis(phenylsulfanyl)ethane, 98% (6099-21-4) C ₁₄ H ₁₄ O ₂ S ₂ ; FW: 278.39; white to off-white powdr. (store cold)		250mg 1g
07-0215	(2S)-(-)-2-[[[3,5-Bis(trifluoromethyl)phenyl]amino]thioxomethyl]amino]-N-(diphenylmethyl)-N,3,3-trimethylbutanamide, 95% (1186602-28-7) See page 188		
07-0283	1-[3,5-Bis(trifluoromethyl)phenyl]-3-[(1R,2R)-(-)-2-(dimethylamino)cyclohexyl]thiourea (R,R-TUC) (620960-26-1) See page 188		
07-0284	1-[3,5-Bis(trifluoromethyl)phenyl]-3-[(1S,2S)-(+)-2-(dimethylamino)cyclohexyl]thiourea (S,S-TUC) (851477-20-8) See page 188		
14-1015	Bis(trimethylsilyl)sulfide, min. 98% (3385-94-2) See page 406		
16-3007	(4R)-4-t-Butyl-1,2,3-oxathiazolidine-2,2-dioxide-3-carboxylic acid t-butyl ester, min. 97% (1313705-92-8) C ₁₁ H ₂₁ NO ₅ S; FW: 279.35; white solid <i>air sensitive</i>		250mg 1g
16-3008	(4S)-4-t-Butyl-1,2,3-oxathiazolidine-2,2-dioxide-3-carboxylic acid t-butyl ester, min. 97% (1206227-45-3) C ₁₁ H ₂₁ NO ₅ S; FW: 279.35; white solid <i>air sensitive</i>		250mg 1g
16-0380	(R)-(+)-t-Butylsulfonamide, min. 97% (196929-78-9) (C ₄ H ₉)S(O)NH ₂ ; FW: 121.20; white powdr.; m.p. 103-107° (store cold) For detailed technical note visit strem.com .		1g 5g 25g
16-0381	(S)-(-)-t-Butylsulfonamide, min. 97% (343338-28-3) (C ₄ H ₉)S(O)NH ₂ ; FW: 121.20; white powdr.; m.p. 97-101° (store cold) For detailed technical note visit strem.com .		1g 5g 25g
16-0517	2-Cyano-2-butylbenzodithiolate (220182-83-2) C ₁₂ H ₁₃ NS ₂ ; FW: 235.37; dark red liq. <i>light sensitive, (store cold)</i> Note: Sold for research purposes only. Not for use in humans or animals. Patents: WO98/01478, WO99/311444. ***Limited quantities available.***		100mg
16-0415	4-Cyano-4-(dodecylsulfanylthiocarbonyl)sulfanylpentanoic acid, min. 97% (870196-80-8) C ₁₉ H ₃₃ NO ₂ S ₃ ; FW: 403.67; pale yellow solid; m.p. 59-62° <i>light sensitive</i> Note: Sold for research purposes only. Not for use in humans or animals. Patents: WO98/01478, WO99/311444. RAFT Agent Kit component. For detailed technical note visit strem.com .		500mg 2g 10g
16-0516	2-Cyano-2-hexylbenzodithiolate (1858249-76-9) C ₁₄ H ₁₇ NS ₂ ; FW: 263.42; dark red liq. <i>light sensitive, (store cold)</i> Note: Sold for research purposes only. Not for use in humans or animals. Patents: WO98/01478, WO99/311444. ***Limited quantities available.***		100mg

SULFUR (Compounds)

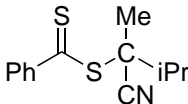
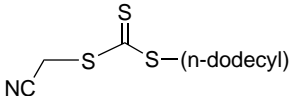
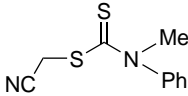
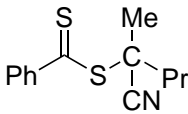
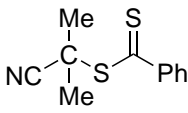
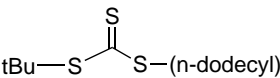
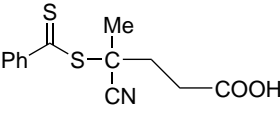
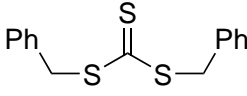
16-0528	2-Cyano-3-methyl-2-butylbenzodithiolate (851729-55-0) C ₁₃ H ₁₅ NS ₂ ; FW: 249.40; dark red liq. <i>light sensitive, (store cold)</i> Note: Sold for research purposes only. Not for use in humans or animals. Patents: WO98/01478, WO99/311444. ***Limited quantities available.***		100mg
16-0425	2-Cyanomethyl-S-dodecyltrithiocarbonate, min. 97% (796045-97-1) C ₁₅ H ₂₇ NS ₃ ; FW: 317.58; yellow-orange solid; m.p. 30-33° <i>light sensitive, (store cold)</i> Note: Sold for research purposes only. Not for use in humans or animals. Patents: WO98/01478, WO99/311444. RAFT Agent Kit component. For detailed technical note visit strem.com .		500mg 2g 10g
16-0423	2-Cyanomethyl-N-methyl-N-phenyldithiocarbamate, min. 97% (76926-16-4) C ₁₀ H ₁₀ N ₂ S ₂ ; FW: 222.33; pale yellow xtl. <i>light sensitive, (store cold)</i> Note: Sold for research purposes only. Not for use in humans or animals. Patents: WO98/01478, WO99/311444. RAFT Agent Kit component. For detailed technical note visit strem.com .		500mg 2g 10g
16-0523	2-Cyano-2-pentylbenzodithiolate (1823273-83-1) C ₁₃ H ₁₅ NS ₂ ; FW: 249.40; dark red liq. <i>light sensitive, (store cold)</i> Note: Sold for research purposes only. Not for use in humans or animals. Patents: WO98/01478, WO99/311444. ***Limited quantities available.***		100mg
16-0430	2-Cyanoprop-2-yl-dithiobenzoate, min. 97% (201611-85-0) C ₁₁ H ₁₁ NS ₂ ; FW: 221.34; purple liq. <i>light sensitive, (store cold)</i> Note: Sold for research purposes only. Not for use in humans or animals. Patents: WO98/01478, WO99/311444. RAFT Agent Kit component. For detailed technical note visit strem.com .		500mg 2g 10g
16-0610	2-(2-Cyanoprop-2-yl)-S-dodecyltrithiocarbonate, min. 97% (870196-83-1) C ₁₇ H ₃₁ NS ₃ ; FW: 345.63; orange liq. <i>light sensitive, (store cold)</i> Note: Sold for research purposes only. Not for use in humans or animals. Patents: WO98/01478, WO99/311444. RAFT Agent Kit component. For detailed technical note visit strem.com .		500mg 2g 10g
16-0422	4-Cyano-4-(thiobenzoylthio)pentanoic acid, min. 97% (201611-92-9) C ₁₃ H ₁₃ NO ₂ S ₂ ; FW: 279.38; pink pwdr. <i>light sensitive, (store cold)</i> Note: Sold for research purposes only. Not for use in humans or animals. Patents: WO98/01478, WO99/311444. RAFT Agent Kit component. For detailed technical note visit strem.com .		500mg 2g 10g
16-0617	S,S-Dibenzyltrithiocarbonate, min. 97% (26504-29-0) C ₁₅ H ₁₄ S ₃ ; FW: 290.47; dark yellow liq. <i>moisture sensitive, (store cold)</i> Note: Sold for research purposes only. Not for use in humans or animals. Patents: WO98/01478, WO99/311444. RAFT Agent Kit component. For detailed technical note visit strem.com .		500mg 2g 10g
16-0450	1,2-Dimercapto-4-methylbenzene, min. 90% (Toluene-3,4-dithiol) (496-74-2) 4-CH ₃ C ₆ H ₃ -1,2-(SH) ₂ ; FW: 156.26; yellow liq.; m.p. 35°; d. 1.179 <i>(store cold)</i>		1g 5g

SULFUR (Compounds)

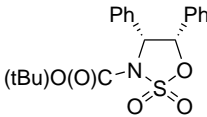
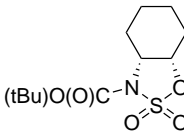
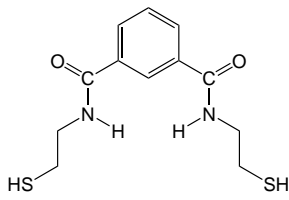
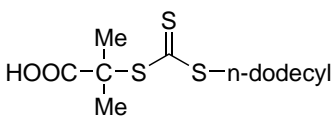
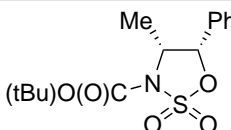
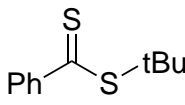
16-3021	(4R,5S)-4,5-Diphenyl-1,2,3-oxathiazolidine-2,2-dioxide-3-carboxylic acid t-butyl ester, min. 97% (1293372-65-2) C ₁₉ H ₂₁ NO ₅ S; FW: 375.44; white solid <i>air sensitive</i>		250mg 1g
16-3020	(4S,5R)-4,5-Diphenyl-1,2,3-oxathiazolidine-2,2-dioxide-3-carboxylic acid t-butyl ester, min. 97% (1091606-63-1) C ₁₉ H ₂₁ NO ₅ S; FW: 375.44; white solid <i>air sensitive</i>		250mg 1g
16-3015	(R,S)-Hexahydro-3H-1,2,3-benzoxathiazole-2,2-dioxide-3-carboxylic acid t-butyl ester, min. 97% (1206227-47-5) C ₁₁ H ₁₉ NO ₅ S; FW: 277.34; white solid <i>air sensitive</i>		250mg 1g
16-3016	(S,R)-Hexahydro-3H-1,2,3-benzoxathiazole-2,2-dioxide-3-carboxylic acid t-butyl ester, min. 97% C ₁₁ H ₁₉ NO ₅ S; FW: 277.34; white solid <i>air sensitive</i>		250mg 1g
16-3025	1,3-(N-Mercaptoethylcarboxamide)benzene, 99% BDET (351994-94-0) C ₁₂ H ₁₆ N ₂ O ₂ S ₂ ; FW: 286.42; white solid; m.p. 132-135°		1g 5g
Technical Note:			
1. Ligand used in a variety of applications involving heavy-metal chelation and amelioration of acute heavy-metal toxicity.			
16-0460	2-Methyl-2-[(dodecylsulfanylthiocarbonyl)sulfanyl]propanoic acid, min. 97% (461642-78-4) C ₁₇ H ₃₂ O ₂ S ₃ ; FW: 364.63; pale yellow solid; m.p. 58-63° <i>light sensitive, (store cold)</i> Note: Sold for research purposes only. Not for use in humans or animals. Patents: WO98/01478, WO99/311444. RAFT Agent Kit component. For detailed technical note visit strem.com .		500mg 2g 10g
16-3002	(4R,5S)-4-Methyl-5-phenyl-1,2,3-oxathiazolidine-2,2-dioxide-3-carboxylic acid t-butyl ester, min. 97% (1380313-48-3) C ₁₄ H ₁₉ NO ₅ S; FW: 313.37; white solid <i>air sensitive</i>		250mg 1g
16-3003	(4S,5R)-4-Methyl-5-phenyl-1,2,3-oxathiazolidine-2,2-dioxide-3-carboxylic acid t-butyl ester, min. 97% (1091606-65-3) C ₁₄ H ₁₉ NO ₅ S; FW: 313.37; white solid <i>air sensitive</i>		250mg 1g
16-0521	2-Methyl-2-propylbenzodithiolate (5925-55-3) C ₁₁ H ₁₄ S ₂ ; FW: 210.36; red-orange liq. <i>light sensitive, (store cold)</i> Note: Sold for research purposes only. Not for use in humans or animals. Patents: WO98/01478, WO99/311444. ***Limited quantities available.***		100mg

SULFUR (Compounds)

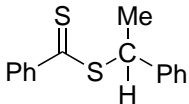
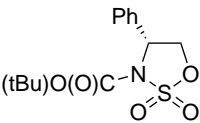
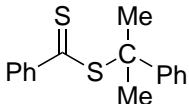
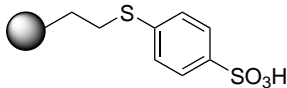
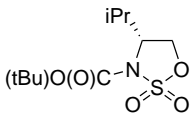
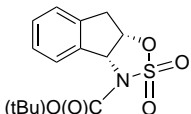
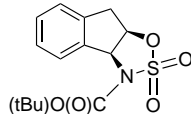
16-0526	2-Phenylethylbenzodithiolate (37912-25-7) C ₁₆ H ₁₄ S ₂ ; FW: 258.40; red-orange liq. <i>light sensitive, (store cold)</i> Note: Sold for research purposes only. Not for use in humans or animals. Patents: WO98/01478, WO99/311444. ***Limited quantities available.***		100mg
16-3030	(4R)-4-Phenyl-1,2,3-oxathiazolidine-2,2-dioxide-3-carboxylic acid t-butyl ester, min. 97% (1209467-60-6) C ₁₃ H ₁₇ NO ₅ S; FW: 299.34; white solid <i>air sensitive, (store cold)</i>		250mg 1g
16-3031	(4S)-4-Phenyl-1,2,3-oxathiazolidine-2,2-dioxide-3-carboxylic acid t-butyl ester, min. 97% (479687-23-5) C ₁₃ H ₁₇ NO ₅ S; FW: 299.34; white solid <i>air sensitive, (store cold)</i>		250mg 1g
16-0513	2-Phenyl-2-propylbenzodithiolate, min. 97% (201611-77-0) C ₁₆ H ₁₆ S ₂ ; FW: 272.43; dark red-purple liq. <i>light sensitive, (store cold)</i> Note: Sold for research purposes only. Not for use in humans or animals. Patents: WO98/01478, WO99/311444. ***Limited quantities available.***		250mg
16-0760	Phenyl sulfonic acid ethyl sulfide Silica (PhosphonicS SPHSA) white to cream solid; SA: 380 m ² /g Note: Sold in collaboration with PhosphonicS Ltd. for research purposes only. Also see 15-0011 page 312		10g 50g
Technical Note:			
1. Applications include esterification, trans-esterification, hydrolysis, rearrangements, dehydration, protection and de-protection, cyclizations, etherifications. At the end of the reaction the solid silica catalyst can simply be filtered from the reaction mixture and reused.			
Particle size range: 315-700 microns			
Average pore size: 60Å			
Functional group loading: 0.5 to 0.8 mmol/g			
References:			
1. <i>Manufacturing Chemist</i> , 2007, July/ August Ed. 27			
16-3010	(4R)-4-i-Propyl-1,2,3-oxathiazolidine-2,2-dioxide-3-carboxylic acid t-butyl ester, min. 97% C ₁₀ H ₁₉ NO ₅ S; FW: 265.33; white solid <i>air sensitive</i>		250mg 1g
16-3011	(4S)-4-i-Propyl-1,2,3-oxathiazolidine-2,2-dioxide-3-carboxylic acid t-butyl ester, min. 97% (1206227-46-4) C ₁₀ H ₁₉ NO ₅ S; FW: 265.33; white solid <i>air sensitive</i>		250mg 1g
96-4700	RAFT Agent Kit for controlling polymerizations at the molecular level See page 544		
16-3006	(4R,5S)-3,3a,8,8a-Tetrahydroindeno[1,2-d]-1,2,3-oxathiazole-2,2-dioxide-3-carboxylic acid t-butyl ester, min. 97% (1391532-95-8) C ₁₄ H ₁₇ NO ₅ S; FW: 311.35; white solid <i>air sensitive</i>		250mg 1g
16-3005	(4S,5R)-3,3a,8,8a-Tetrahydroindeno[1,2-d]-1,2,3-oxathiazole-2,2-dioxide-3-carboxylic acid t-butyl ester, min. 97% (1091606-66-4) C ₁₄ H ₁₇ NO ₅ S; FW: 311.35; white solid <i>air sensitive</i>		250mg 1g

SULFUR (Compounds)

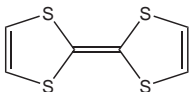
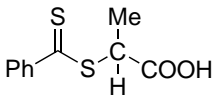
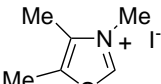
16-2250	Tetrathiafulvalene, 98+% TTF (31366-25-3) C ₆ H ₂ S ₄ ; FW: 204.35; orange xtl.; m.p. 113-116° <i>light sensitive</i>		250mg 1g
16-0532	2-(Thiobenzoylthio)propionic acid, min. 97% (78751-36-7) C ₁₀ H ₁₀ O ₂ S ₂ ; FW: 226.32 <i>light sensitive, (store cold)</i> Note: Sold for research purposes only. Not for use in humans or animals. Patents: WO98/01478, WO99/311444. ***Limited quantities available.***		100mg 500mg
16-2230	3,4,5-Trimethylthiazolium iodide, 99% (62993-85-5) C ₆ H ₁₀ I _{NS} ; FW: 255.12; white solid <i>moisture sensitive</i> For detailed technical note visit strem.com .		1g 5g

TANTALUM (Elemental Forms)

73-0040	Tantalum foil (99.95%) (7440-25-7) Ta; FW: 180.95; 1mm thick (~10.4g/25 x 25mm); m.p. 2996°; b.p. 5425°; d. 16.6	25 x 25mm 50 x 50mm 100 x 100mm
73-0045	Tantalum foil (99.95%) (7440-25-7) Ta; FW: 180.95; 0.5mm thick (~20.8g/50 x 50mm); m.p. 2996°; b.p. 5425°; d. 16.6	50 x 50mm 100 x 100mm 200 x 200mm
73-0050	Tantalum foil (99.95%) (7440-25-7) Ta; FW: 180.95; 0.127mm thick (~5.3g/50 x 50mm); m.p. 2996°; b.p. 5425°; d. 16.6	50 x 50mm 100 x 100mm 200 x 200mm
93-7332 HAZ	Tantalum powder (99.98%, Nb-25ppm) (7440-25-7) Ta; FW: 180.95; -325 mesh; m.p. 2996°; b.p. 5425°; d. 16.6	10g 50g
93-7330 HAZ	Tantalum powder (99.98%, Nb-25ppm) (7440-25-7) Ta; FW: 180.95; avg. particle size 5.7-9.5 micron; m.p. 2996°; b.p. 5425°; d. 16.6	10g 50g
73-0065	Tantalum rod (99.95%) (7440-25-7) Ta; FW: 180.95; 12.5mm dia. (~20.4g/cm); m.p. 2996°; b.p. 5425°; d. 16.6	1cm 5cm 25cm
73-0070	Tantalum rod (99.95%) (7440-25-7) Ta; FW: 180.95; 6.35mm dia. (~5.1g/cm); m.p. 2996°; b.p. 5425°; d. 16.6	5cm 25cm
73-0075	Tantalum wire (99.95%) (7440-25-7) Ta; FW: 180.95; 1mm dia. (~13g/m); m.p. 2996°; b.p. 5425°; d. 16.6	1m 5m 25m
73-0080	Tantalum wire (99.95%) (7440-25-7) Ta; FW: 180.95; 0.5mm dia. (~3.3g/m); m.p. 2996°; b.p. 5425°; d. 16.6	1m 5m 25m
73-0085	Tantalum wire (99.95%) (7440-25-7) Ta; FW: 180.95; 0.25mm dia. (~0.82g/m); m.p. 2996°; b.p. 5425°; d. 16.6	10m 50m

TANTALUM (Compounds)

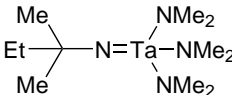
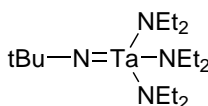
73-0490	t-Amylimidotris(dimethylamino)tantalum(V) TAIMATA (629654-53-1) C ₁₁ H ₂₉ N ₄ Ta; FW: 398.32; colorless solid <i>air sensitive, moisture sensitive</i>		1g 5g
73-0723	(t-Butylimido)tris(diethylamino)tantalum(V), min. 98% (99.99%-Ta) PURATREM TBTDET (169896-41-7) C ₁₆ H ₃₉ N ₄ Ta; FW: 468.45; colorless to pale yellow liq.; d. 1.252 g/ml@25°C <i>air sensitive, moisture sensitive</i> For detailed technical note visit strem.com .		250mg 1g 5g

TANTALUM (Compounds)

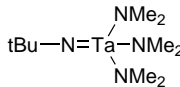
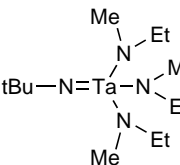
73-0700	t-Butylimidotris(dimethylamino) tantalum(V), min. 98% (69039-11-8) C ₁₀ H ₂₇ N ₃ Ta; FW: 384.30; pale-yellow solid <i>air sensitive, moisture sensitive</i> Note: Available prepacked in ALD cylinder- see 98-4045.		1g 5g
98-4045	t-Butylimidotris(dimethylamino)tantalum(V), min. 98%, 73-0700, contained in 50 ml Swagelok® cylinder (96-1070) for CVD/ALD (69039-11-8) C ₁₀ H ₂₇ N ₃ Ta; FW: 384.30; colorless solid <i>air sensitive, moisture sensitive</i> Note: High temperature Swagelok® cylinder assembly 96-1071 available at extra cost.		10g 25g
73-0735	(t-Butylimido)tris(ethylmethylamino)tantalum(V) (99.99%-Ta) PURATREM (511292-99-2) C ₁₃ H ₃₃ N ₃ Ta; FW: 426.38; yellow liq. <i>air sensitive, moisture sensitive</i>		1g 5g 25g
73-0800	Pentakis(dimethylamino)tantalum(V), 99% (19824-59-0) amp Ta[N(CH ₃) ₂] ₅ ; FW: 401.33; orange xtl.; m.p. >100° (dec.); b.p. subl. 100°/0.1mm <i>moisture sensitive</i>		1g 5g 25g
73-0900	Pentamethylcyclopentadienyltantalum tetrachloride, 98% (71414-47-6) amp [C ₅ (CH ₃) ₅]TaCl ₄ ; FW: 458.00; orange powdr.; m.p. 220° <i>air sensitive, moisture sensitive</i>		1g 5g
93-7305	Tantalum(V) bromide (99.9%-Ta) (13451-11-1) HAZ TaBr ₅ ; FW: 580.49; yellow powdr.; m.p. 265°; b.p. 348.8°; d. 4.67 <i>moisture sensitive</i>		5g 25g
73-0950	Tantalum(V) n-butoxide (99.99+%-Ta) PURATREM (51094-78-1) C ₂₀ H ₄₅ O ₅ Ta; FW: 546.52; colorless to light yellow liq.; d. 1.31 <i>air sensitive, moisture sensitive</i> For detailed technical note visit strem.com .		5g 25g
73-0750	Tantalum carbide (99.5%-Ta) (12070-06-3) TaC; FW: 192.96; -325 mesh powdr. (avg. 10 microns or less); m.p. 3880°		5g 25g 100g
73-1000	Tantalum(V) chloride, anhydrous (99.9%-Ta) (7721-01-9) amp HAZ TaCl ₅ ; FW: 358.21; white to yellow powdr.; m.p. 216-220° (subl. 144°); b.p. 232-235°; d. 3.68 <i>moisture sensitive</i>		10g 50g
93-7324	Tantalum(V) chloride, resublimed (99.99+%-Ta) PURATREM (7721-01-9) amp HAZ TaCl ₅ ; FW: 358.21; white powdr.; m.p. 216° (subl. 144°); b.p. 242°; d. 3.68 <i>moisture sensitive</i>		10g 50g
93-7303	Tantalum(V) ethoxide (99.99+%-Ta) PURATREM (6074-84-6) amp HAZ Ta(OC ₂ H ₅) ₅ ; FW: 406.26; colorless to yellow liq.; m.p. 21°; b.p. 145°/0.1 mm; f.p. 87°F; d. 1.56 <i>moisture sensitive</i>		10g 50g 5 x 50g
73-1080	Tantalum(V) ethoxide (99.9999%-Ta) PURATREM (6074-84-6) amp HAZ Ta(OC ₂ H ₅) ₅ ; FW: 406.26; yellow liq.; m.p. 21°; b.p. 145°/0.1mm; f.p. 87°F; d. 1.56 <i>moisture sensitive</i> Note: Limited quantities available.		1g
93-7325	Tantalum(V) fluoride, 99.5% (7783-71-3) HAZ TaF ₅ ; FW: 275.94; off-white powdr.; m.p. 96.8°; b.p. 229.5°; d. 4.74 <i>moisture sensitive</i> Note: Packaged in PFA/FET bottle.		5g 25g
93-7329	Tantalum(V) methoxide (99.99+%-Ta) PURATREM (865-35-0) HAZ Ta(OCH ₃) ₅ ; FW: 336.12; white powdr.; m.p. 50°; b.p. 189°/10 mm <i>moisture sensitive</i>		2g 10g
73-2000	Tantalum(V) oxide, 99.8% (99.95+%-Ta) (1314-61-0) Ta ₂ O ₅ ; FW: 441.89; white powdr.; m.p. 1800°; d. 8.2		25g 100g

TANTALUM (Compounds)

93-7306	Tantalum(V) oxide, 99.8% (99.99+%-Ta) PURATREM (1314-61-0) Ta ₂ O ₅ ; FW: 441.89; white powdr.; m.p. 1800°; d. 8.2	10g 50g
93-7310	Tantalum silicide (99.5%-Ta) (12039-79-1) TaSi ₂ ; FW: 237.12; -325 mesh gray powdr. (avg. 10 microns or less); m.p. 2200°; d. 9.14	5g 25g
73-5000 HAZ	Tantalum(V) (tetraethoxy)(acetylacetonate) (99.99+%-Ta) PURATREM (20219-33-4) Ta(OC ₂ H ₅) ₄ (CH ₃ COCHCOCH ₃); FW: 460.30; yellow solid; m.p. 45°; b.p. 95°/0.5mm; d. 1.5 <i>moisture sensitive</i>	10g 50g
73-7373	Tantalum(V) (tetraethoxy)[BREW] (99.99+%-Ta) PURATREM Ta(C ₂ H ₅ O) ₄ [C-HyC(O)CHC(O)C-Hy] ₂ (x=3-4, y=2x+1); pale brown liq. <i>moisture sensitive</i> Note: ***Limited quantities available. Will discontinue when stock gone***	1g 5g

TELLURIUM (Elemental Forms)

93-5224 HAZ	Tellurium broken ingot (99.99+%) (13494-80-9) Te; FW: 127.60; m.p. 449.5°; b.p. 989.8°; d. 6.24	25g 100g
52-0070 HAZ	Tellurium broken ingot (99.999%) (13494-80-9) Te; FW: 127.60; 25mm and down; m.p. 449.5°; b.p. 989.8°; d. 6.24	25g 100g 500g
52-0030 HAZ	Tellurium broken ingot (99.9999%) (13494-80-9) Te; FW: 127.60; 2cm and down; m.p. 449.5°; b.p. 989.8°; d. 6.24	10g 50g
93-5222 HAZ	Tellurium powder (99.8%) (13494-80-9) Te; FW: 127.60; -100 mesh; m.p. 449.5°; b.p. 989.8°; d. 6.24	25g 100g 500g
52-5200 HAZ	Tellurium powder (99.9%) (13494-80-9) Te; FW: 127.60; -325 mesh	25g 100g 500g
93-5220 HAZ	Tellurium powder (99.999%) (13494-80-9) Te; FW: 127.60; 60 mesh; m.p. 449.5°; b.p. 989.8°; d. 6.24	10g 50g

TELLURIUM (Compounds)

93-1949	Potassium tellurite(IV) hydrate, 97% (123333-66-4) See page 344	
93-5203 HAZ	Telluric acid (99.5%-Te) (13451-14-4) H ₂ TeO ₄ ·2H ₂ O; FW: 193.61 (229.64); white powdr.; m.p. 136°; b.p. 160° dec.; d. 3.071	5g 25g
52-7000 HAZ	Tellurium(IV) bromide (99.9%-Te) (10031-27-3) TeBr ₄ ; FW: 447.22; -4 mesh powdr.; m.p. 363° <i>moisture sensitive</i>	10g 50g
93-5205 HAZ	Tellurium(IV) chloride (99.9%-Te) (10026-07-0) TeCl ₄ ; FW: 269.41; off-white powdr.; m.p. 224°; b.p. 380°; d. 3.26 <i>moisture sensitive</i>	10g 50g
93-5215	Tellurium(IV) iodide (99.9%-Te) (7790-48-9) TeI ₄ ; FW: 635.22; -4 mesh gran.; m.p. 280°; d. 5.403 <i>moisture sensitive</i>	2g 10g
93-5204	Tellurium(IV) oxide, 99+% (7446-07-3) TeO ₂ ; FW: 159.60; off-white powdr.; m.p. 733°; b.p. 450° subl.	50g 250g
93-5216	Tellurium(IV) oxide (99.999%-Te) PURATREM (7446-07-3) TeO ₂ ; FW: 159.60; off-white powdr.; m.p. 733°; b.p. 450° subl.	10g 50g

TERBIUM (Elemental Forms)

93-6516	Terbium chips (99.9% REO) (7440-27-9) Tb; FW: 158.92; 12mm and down; m.p. 1360°; b.p. 3041°; d. 8.234 <i>air sensitive, moisture sensitive</i>	1g 5g
93-6520	Terbium foil (99.9% REO) (7440-27-9) Tb; FW: 158.92; 0.62 mm thick (~3.2g/25 x 25 mm); m.p. 1360°; b.p. 3041°; d. 8.234 <i>air sensitive, moisture sensitive</i>	25 x 25mm 50 x 50mm

TERBIUM (Elemental Forms)

93-6519	Terbium foil (99.9% REO) (7440-27-9) Tb; FW: 158.92; 0.25 mm thick (~1.30g/25x 25 mm); m.p. 1360°; b.p. 3041°; d. 8.234 <i>air sensitive, moisture sensitive</i>	25 x 25mm 50 x 50mm
93-6517	Terbium ingot (99.9% REO) (7440-27-9) Tb; FW: 158.92; metal piece; m.p. 1360°; b.p. 3041°; d. 8.234 <i>air sensitive, moisture sensitive</i>	2g 10g
93-6515	Terbium powder (99.9% REO) (7440-27-9) HAZ Tb; FW: 158.92; -40 mesh; m.p. 1360°; b.p. 3041°; d. 8.234 <i>air sensitive, moisture sensitive</i>	1g 5g

TERBIUM (Compounds)

93-6501	Terbium(III) acetylacetonate trihydrate (99.9%-Tb) (REO) (14284-95-8) Tb(CH ₃ COCHCOCH ₃) ₃ ·3H ₂ O; FW: 456.26 (510.31); white powdr.; m.p. 168-170° <i>hygroscopic</i>	1g 5g
93-6511	Terbium(III) carbonate hydrate (99.9%-Tb) (REO) (100587-96-0) Tb ₂ (CO ₃) ₃ ·XH ₂ O; FW: 497.88; white powdr.	2g 10g
93-6507	Terbium(III) chloride, anhydrous (99.9%-Tb) (REO) (10042-88-3) TbCl ₃ ; FW: 265.29; off-white powdr.; m.p. 588° <i>hygroscopic</i>	2g 10g
93-6502	Terbium(III) chloride hexahydrate (99.9%-Tb) (REO) (13798-24-8) TbCl ₃ ·6H ₂ O; FW: 265.29 (373.38); white xtl.	5g 25g
65-6502	Terbium(III) chloride hydrate (99.995%-Tb) (REO) PURATREM (13798-24-8) TbCl ₃ ·XH ₂ O; FW: 265.29; white xtl.	5g 25g
93-6508	Terbium(III) nitrate hexahydrate (99.9%-Tb) (REO) (13451-19-9) HAZ Tb(NO ₃) ₃ ·6H ₂ O; FW: 344.94 (453.04); white xtl.	5g 25g
93-6505	Terbium(III,IV) oxide (99.9%-Tb) (REO) (12037-01-3) Tb ₄ O ₇ ; FW: 747.69; brown to black powdr.	5g 25g
93-6512	Terbium(III) perchlorate, 50% aqueous solution (99.9%-Tb) (REO) (14014-09-6) HAZ Tb(ClO ₄) ₃ ; FW: 457.28; colorless liq.	2g 10g
65-6000	Terbium(III) trifluoromethanesulfonate, min. 98% (Terbium triflate) (148980-31-8) Tb(CF ₃ SO ₃) ₃ ; FW: 606.14; white powdr. <i>hygroscopic</i>	1g 5g
65-7000	Tris(i-propylcyclopentadienyl)terbium (99.9%-Tb) (REO) (312696-25-6) amp (C ₅ H ₇ C ₅ H ₄) ₃ Tb; FW: 480.45; yellow solid <i>air sensitive</i>	1g 5g
65-8000	Tris(2,2,6,6-tetramethyl-3,5-heptanedionato)terbium(III), 99% (99.9%-Tb) (REO) [Tb(TMHD)₃] (15492-51-0) Tb(C ₁₁ H ₁₉ O ₂) ₃ ; FW: 708.74; off-white xtl.; m.p. 155-156°; b.p. dec. 275°	1g 5g

THALLIUM (Elemental Forms)

81-0054	Thallium granules (99.9%) (7440-28-0) HAZ Tl; FW: 204.37; 6mm and down (under water); m.p. 303.5°; b.p. 1457°; d. 11.85	25g 100g
---------	---	-------------

THALLIUM (Compounds)

81-0300	Cyclopentadienylthallium, 95% (34822-90-7) HAZ C ₅ H ₅ Tl; FW: 269.47; light brown xtl.; m.p. subl. 75°/0.1mm <i>air sensitive, (store cold)</i>	10g 50g
81-0305	Cyclopentadienylthallium, 99% (99.9%-Tl) sublimed (34822-90-7) HAZ C ₅ H ₅ Tl; FW: 269.47; yellow xtl.; m.p. subl. 75°/0.1mm <i>air sensitive, (store cold)</i>	1g 5g 25g
81-1000	2,2,6,6-Tetramethyl-3,5-heptanedionatothallium(I), 99% [Tl(TMHD)] (56713-38-3) HAZ Tl(C ₁₁ H ₁₉ O ₂); FW: 387.62; white to off-white powdr.; m.p. 159-164°; b.p. dec. 260° (subl. 110°/0.1mm)	1g 5g
93-8136	Thallium(I) acetate (99.9985%-Tl) PURATREM (563-68-8) HAZ TlOOCCH ₃ ; FW: 263.42; white powdr.; m.p. 131° <i>hygroscopic</i>	10g 50g

THALLIUM (Compounds)

93-8101 HAZ	Thallium(III) acetate hydrate (62811-75-0) Tl(OOCCH ₃) ₃ ·XH ₂ O; FW: 381.52; white xtl. <i>light sensitive</i>	10g 50g
93-8115 HAZ	Thallium(I) acetylacetonate, 99% (25955-51-5) Tl(CH ₃ COCHCOCH ₃) ₃ ; FW: 303.50; white powdr.	5g 25g
93-8103 HAZ	Thallium(I) bromide (99.999%-Tl) PURATREM (7789-40-4) TlBr; FW: 284.28; yellow powdr.; m.p. 480°; b.p. 815°; d. 7.557	10g 50g
93-8105 HAZ	Thallium(I) ethoxide, min. 95% (20398-06-5) Tl(OC ₂ H ₅) ₃ ; FW: 249.43; cloudy, dense liq.; m.p. -3°; b.p. 130° dec.; d. 3.493 (20°) <i>moisture sensitive</i> Note: May contain a precipitate.	5g 25g
81-2400 HAZ	Thallium(I) 2-ethylhexanoate, superconductor grade (56-59% Tl) Tl[OOCCH(C ₂ H ₅)C ₄ H ₉]; FW: 347.59; waxy solid	25g 100g
93-8106 HAZ	Thallium(I) fluoride, 99% (7789-27-7) TlF; FW: 223.37; white powdr.; m.p. 327°; b.p. 655°; d. 8.23	10g 50g
81-2500 HAZ	Thallium(I) hexafluoroacetylacetonate, 99% (99.9%-Tl) (15444-43-6) TlCF ₃ COCHCOCF ₃ ; FW: 411.42; yellow xtl.; m.p. 126-128°; b.p. dec. 220° (subl. 140°/0.1mm)	1g 5g
81-3000 HAZ	Thallium(I) hexafluorophosphate, min. 97% (60969-19-9) TlPF ₆ ; FW: 349.34; white xtl.	1g 5g 25g
81-4500 HAZ	Thallium hydrotris(indazol-2-yl)borate, min. 98% (162978-03-2) [C ₂₁ H ₁₈ BN ₃]Tl; FW: 567.60; white powdr.; m.p. 254-256°	250mg 1g
81-5000 HAZ	Thallium hydrotris[3-(2-pyridyl)pyrazol-1-yl]borate, min. 98% (165257-90-9) [C ₂₄ H ₁₈ BN ₃]Tl; FW: 648.66; white powdr.; m.p. 283-285°	250mg 1g
93-8108 HAZ	Thallium(I) iodide (99.999%-Tl) PURATREM (7790-30-9) TlI; FW: 331.27; yellow powdr.; m.p. 440°; b.p. 823°; d. 7.09	5g 25g
93-8109 HAZ	Thallium(I) nitrate (99.5%-Tl) (10102-45-1) TlNO ₃ ; FW: 266.37; white xtl.; m.p. 206°; b.p. 430°	25g 100g
81-6750 HAZ	Thallium(I) nitrate (99.99%-Tl) PURATREM (10102-45-1) TlNO ₃ ; FW: 266.37; white xtl.; m.p. 206°; b.p. 430°	10g 50g 250g
93-8117 HAZ	Thallium(III) oxide (99.5%-Tl) (1314-32-5) Tl ₂ O ₃ ; FW: 456.74; black powdr.; m.p. -717°	25g 100g
81-8100 HAZ	Thallium(III) oxide (99.99%-Tl) PURATREM (1314-32-5) Tl ₂ O ₃ ; FW: 456.74; black powdr.; m.p. -717°	10g 50g
93-8121 HAZ	Thallium(I) sulfate (99.5%-Tl) (7446-18-6) Tl ₂ SO ₄ ; FW: 504.80; white powdr.; m.p. 632°; b.p. dec.; d. 6.77	25g 100g
81-8200 HAZ	Thallium(I) sulfate (99.999%-Tl) PURATREM (7446-18-6) Tl ₂ SO ₄ ; FW: 504.80; white xtl.; m.p. 632°; b.p. dec.; d. 6.77	5g 25g
93-8137 HAZ	Thallium(III) trifluoroacetate, tech. gr. (23586-53-0) Tl(OOCCF ₃) ₃ ; FW: 543.45; white powdr.; m.p. 169° <i>heat sensitive, hygroscopic, (store cold)</i>	5g 25g

THALLIUM (Compounds)

81-8500	Thallium(I) trifluoromethanesulfonate, 99% (Thallium triflate) (73491-36-8)	1g
HAZ	TlSO ₃ CF ₃ ; FW: 353.45; white pwdr. <i>hygroscopic</i>	5g 25g

THORIUM (Compounds)

93-9002	Thorium(IV) fluoride, anhydrous (99.9%-Th) (13709-59-6)	10g
amp	ThF ₄ ; FW: 308.03; white pwdr.; m.p. > 900°; d. 6.32	2 x 25g
HAZ	<i>hygroscopic</i>	
93-9006	Thorium(IV) nitrate hydrate (99.8%-Th) (61443-54-7)	25g
HAZ	Th(NO ₃) ₄ ·xH ₂ O; FW: 480.06; white xtl. <i>hygroscopic</i>	4 x 25g

THULIUM (Elemental Forms)

93-6918	Thulium foil (99.9% REO) (7440-30-4)	25 x 25mm
	Tm; FW: 168.93; 0.25 mm thick (~1.5g/25 x 25 mm); m.p. 1545°; b.p. 1727°; d. 9.332 <i>air sensitive, moisture sensitive</i>	50 x 50mm
93-6917	Thulium pieces (99.9% REO) (7440-30-4)	1g
	Tm; FW: 168.93; broken crystals; m.p. 1545°; b.p. 1727°; d. 9.332 <i>air sensitive, moisture sensitive</i>	5g
93-6915	Thulium powder (99.9% REO) (7440-30-4)	1g
HAZ	Tm; FW: 168.93; -40 mesh; m.p. 1545°; b.p. 1727°; d. 9.332 <i>air sensitive, moisture sensitive</i>	5g

THULIUM (Compounds)

93-6911	Thulium(III) acetate tetrahydrate (99.9%-Tm) (REO) (34431-47-5)	1g
	Tm(OOCCCH ₃) ₃ ·4H ₂ O; FW: 346.07 (418.13); white pwdr.	5g
93-6910	Thulium(III) acetylacetonate trihydrate (99.9%-Tm) (REO) (14589-44-7)	1g
	Tm(CH ₃ COCHCOCH ₃) ₃ ·3H ₂ O; FW: 466.27 (520.32); white pwdr.	5g
93-6901	Thulium(III) chloride, anhydrous (99.9%-Tm) (REO) (13537-18-3)	1g
	TmCl ₃ ; FW: 275.29; off-white pwdr.; m.p. 821° <i>hygroscopic</i>	5g
93-6902	Thulium(III) chloride hydrate (99.9%-Tm) (REO) (19423-86-0)	1g
	TmCl ₃ ·xH ₂ O; FW: 275.29; light green xtl.; m.p. 821° (anhydrous)	5g
93-6913	Thulium(III) nitrate hexahydrate (99.9%-Tm) (REO) (36548-87-5)	1g
HAZ	Tm(NO ₃) ₃ ·6H ₂ O; FW: 354.95 (463.04); off-white xtl.	5g
93-6912	Thulium(III) oxalate hydrate (99.9%-Tm) (REO) (26677-68-9)	1g
	Tm ₂ (C ₂ O ₄) ₃ ·xH ₂ O; FW: 601.93; white pwdr.	5g
93-6904	Thulium(III) oxide (99.9%-Tm) (REO) (12036-44-1)	1g
	Tm ₂ O ₃ ; FW: 385.87; white pwdr.	5g
69-5000	Thulium(III) trifluoromethanesulfonate, min. 98% (Thulium triflate) (141478-68-4)	500mg
	Tm(CF ₃ SO ₃) ₃ ; FW: 616.14; white pwdr. <i>hygroscopic</i>	2g
69-6000	Tris(cyclopentadienyl)thulium (99.9%-Tm) (REO) (1272-26-0)	1g
amp	(C ₅ H ₅) ₃ Tm; FW: 364.22; greenish yellow xtls. <i>air sensitive, moisture sensitive</i>	5g
69-7000	Tris(2,2,6,6-tetramethyl-3,5-heptanedionato)thulium(III), 98% (99.9%-Tm) (REO) [Tm(TMHD)] (15631-58-0)	1g
	Tm(C ₁₁ H ₁₉ O ₂) ₃ ; FW: 718.75; off-white xtl.; m.p. 169-172°; b.p. dec. 280°	5g

TIN (Elemental Forms)

93-5091	Tin foil (99.99%) (7440-31-5)	100 x 25mm
	Sn; FW: 118.70; 0.127 mm thick x 25 mm wide; m.p. 231.9°; b.p. 2260°; d. 7.31	500 x 25mm
50-0250	Tin foil (99.998%) (7440-31-5)	50 x 50mm
	Sn; FW: 118.70; 0.25mm thick (~4.6g/50 x 50mm); m.p. 231.9°; b.p. 2260°; d. 7.31	100 x 100mm
93-5089	Tin powder (99.5%) (7440-31-5)	100g
	Sn; FW: 118.70; -100 mesh; m.p. 231.9°; b.p. 2260°; d. 7.31	500g

TIN (Elemental Forms)

93-5086	Tin powder (99.8%) (7440-31-5) Sn; FW: 118.70; -325 mesh; m.p. 231.9°; b.p. 2260°; d. 7.31	50g 250g
93-5090	Tin powder (99.995%) (7440-31-5) Sn; FW: 118.70; -100 mesh; m.p. 231.9°; b.p. 2260°; d. 7.31	10g 50g
93-5088	Tin shot (99.8%) (7440-31-5) Sn; FW: 118.70; 8-20 mesh; m.p. 231.9°; b.p. 2260°; d. 7.31	50g 250g
50-0070	Tin shot (99.999%) (7440-31-5) Sn; FW: 118.70; 1-3 mm; m.p. 231.9°; b.p. 2260°; d. 7.31	5g 25g
50-0080	Tin shot (99.9999%) (7440-31-5) Sn; FW: 118.70; 3 mm; m.p. 231.9°; b.p. 2260°; d. 7.31	5g 25g 100g

TIN (Compounds)

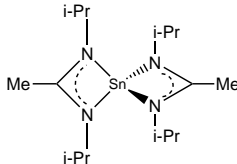
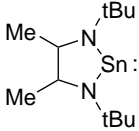
50-1170 amp	Bis(N,N'-di-i-propylacetamidinato)tin(II), 99% (1421599-46-3) Sn(C ₈ H ₁₇ N ₂) ₂ ; FW: 401.18; white xtls. <i>air sensitive, moisture sensitive</i> Note: Product sold under, use subject to, terms and conditions of label license at www.strem.com/harvard2 . For detailed technical note visit strem.com .	250mg 1g 5g	
50-0700 HAZ	Bis(tri-n-butyltin)oxide, 96% (56-35-9) [(n-C ₄ H ₉) ₃ Sn] ₂ O; FW: 596.07; colorless liq.; b.p. 254°/50 mm; f.p. >230°F; d. 1.17 (25°) <i>moisture sensitive</i>	100g 500g	
93-5058	Bis(tri-n-butyltin)sulfate, min. 97% (26377-04-8) [(C ₄ H ₉) ₃ Sn] ₂ SO ₄ ; FW: 676.14; white powdr.	25g 100g	
93-5002 HAZ	Bis(tri-n-butyltin)sulfide, 97% (4808-30-4) [(C ₄ H ₉) ₃ Sn] ₂ S; FW: 612.14; colorless liq.; d. 1.197 g/cm ³ at 20°C	5g 25g 100g	
50-0900 HAZ	Bis(trimethyltin)acetylene, 99% (2117-50-2) (CH ₃) ₃ SnC≡CSn(CH ₃) ₃ ; FW: 351.61; white xtl.; m.p. 56° <i>air sensitive</i>	1g 5g	
93-5078	n-Butyltin hydroxide oxide hydrate, 97% (336879-56-2) C ₄ H ₉ SnOOH·XH ₂ O; FW: 208.81; white powdr.	50g 250g	
93-5004 HAZ	n-Butyltin trichloride, min. 95% (1118-46-3) C ₄ H ₉ SnCl ₃ ; FW: 282.17; colorless to yellow liq.; m.p. -63°; b.p. 98°/10 mm; f.p. 178°F; d. 1.693 <i>moisture sensitive</i>	50g 250g	
50-1150 amp	N,N'-Di-t-butyl-2,3-diamidobutanetin(II), 98% (1268357-44-3) C ₁₂ H ₂₆ N ₂ Sn; FW: 317.06; orange powdr. <i>moisture sensitive, (store cold)</i> Note: ALD Precursor. US Patent Application 61/320,069 filed April 1, 2010. Product sold under, use subject to, terms and conditions of label license at www.strem.com/harvard3 . Available prepacked in ALD cylinder- see 98-4052 page 434 For detailed technical note visit strem.com .	250mg 1g 5g	
98-4052	N,N'-Di-t-butyl-2,3-diamidobutanetin(II), 98%, 50-1150, contained in 50 ml Swagelok® cylinder (96-1070) for CVD/ALD (1268357-44-3) C ₁₂ H ₂₆ N ₂ Sn; FW: 317.06; white to off-white powdr. <i>air sensitive, moisture sensitive, (store cold)</i> Note: ALD Precursor. US Patent Application 61/320,069 filed April 1, 2010. Product sold under, use subject to, terms and conditions of label license at www.strem.com/harvard3 .	5g	
50-1050	Di-n-butyltinbis(acetylacetonate) (22673-19-4) (C ₄ H ₉) ₂ Sn(CH ₃ COCHCOCH ₃) ₂ ; FW: 431.16; pale yellow to amber liq.; m.p. 26°; b.p. 150°/3mm; d. 1.21	100g 500g	
93-5007 HAZ	Di-n-butyltin diacetate, min. 96% (1067-33-0) (C ₄ H ₉) ₂ Sn(OOCCH ₃) ₂ ; FW: 351.01; colorless liq.; m.p. 10°; f.p. >230°F; d. 1.32	100g 500g	

TIN (Compounds)

50-1130 HAZ	Di-n-butyltin dichloride, min. 95% (683-18-1) (n-C ₄ H ₉) ₂ SnCl ₂ ; FW: 303.83; white xtl.; m.p. 39-41°; d. 1.36 <i>air sensitive, moisture sensitive</i>	50g 250g 1kg
50-1140 HAZ	Di-t-butyltin dichloride, 98% (19429-30-2) (t-C ₄ H ₉) ₂ SnCl ₂ ; FW: 303.83; white xtl.; m.p. 42-43°; b.p. 66°/3 mm <i>moisture sensitive</i>	1g 5g
93-5009 HAZ	Di-n-butyltin dilaurate, 98% (77-58-7) (C ₄ H ₉) ₂ Sn(OOCC ₁₁ H ₂₃) ₂ ; FW: 631.55; yellow liq.; m.p. 24°; f.p. >230°F; d. 1.066	250g 1kg
93-5010 HAZ	Di-n-butyltin oxide, 98% (818-08-6) (C ₄ H ₉) ₂ SnO; FW: 248.92; white powdr.; m.p. dec.	100g 500g
93-5015	Dimethyldiphenyltin (1080-43-9) (CH ₃) ₂ Sn(C ₆ H ₅) ₂ ; FW: 302.97; colorless liq.	5g 25g
50-1160 HAZ	Dimethyltin dichloride, min. 95% (753-73-1) (CH ₃) ₂ SnCl ₂ ; FW: 219.67; white xtl.; m.p. 107-108°; b.p. 188-190° <i>moisture sensitive</i>	5g 25g
93-5014	Dimethyltin oxide, min. 97% (2273-45-2) (CH ₃) ₂ SnO; FW: 164.78; white powdr.; m.p. dec.	5g 25g
93-5016	Diphenyltin dichloride, 96% (1135-99-5) (C ₆ H ₅) ₂ SnCl ₂ ; FW: 343.81; white xtl.; m.p. 41-43°; b.p. 333-337° dec. <i>moisture sensitive</i>	10g 50g
93-5017	Diphenyltin oxide, 98% (2273-51-0) (C ₆ H ₅) ₂ SnO; FW: 288.90; white powdr.	5g 25g
93-5018	Diphenyltin sulfide, 99% (20332-10-9) (C ₆ H ₅) ₂ SnS; FW: 304.97; white powdr.	1g 5g
50-1250 HAZ	Divinyltin dichloride, 98% (7532-85-6) (CH ₂ =CH) ₂ SnCl ₂ ; FW: 243.69; colorless liq.; b.p. 54-56°/3 mm <i>moisture sensitive</i>	10g 50g
93-5019 HAZ	Hexa-n-butyltin, min. 95% (813-19-4) (C ₄ H ₉) ₆ SnSn(C ₄ H ₉) ₅ ; FW: 580.08; colorless to yellow liq.; b.p. 198°/10 mm; f.p. >230°F; d. 1.1480 <i>air sensitive</i>	10g 50g
50-1500 HAZ	Hexamethylditin, 99% (661-69-8) (CH ₃) ₆ SnSn(CH ₃) ₅ ; FW: 327.59; colorless, low-melting solid; m.p. 23°; b.p. 85-88°/45 mm; f.p. 142°F; d. 1.58 <i>air sensitive, moisture sensitive, (store cold)</i>	1g 5g 25g
93-5079	Hexaphenylditin, 99+% (1064-10-4) (C ₆ H ₅) ₆ SnSn(C ₆ H ₅) ₅ ; FW: 700.02; white powdr.; m.p. 232.5°; b.p. 280° dec.	2g 10g
50-1600 HAZ	Methyltin trichloride, 98+% (993-16-8) CH ₃ SnCl ₃ ; FW: 240.08; white xtl.; m.p. 43° <i>moisture sensitive</i>	2g 10g
50-1780 HAZ	Phenyltin trichloride, min. 98% (1124-19-2) C ₆ H ₅ SnCl ₃ ; FW: 302.16; colorless liq.; b.p. 130-132°/12 mm; f.p. >230°F; d. 1.839 <i>moisture sensitive</i>	2g 10g
93-5080 HAZ	Tetraallyltin, min. 95% (7393-43-3) Sn(CH ₂ CH=CH ₂) ₄ ; FW: 282.98; light yellow liq.; f.p. 167°F; d. 1.179	2g 10g
93-5049 HAZ	Tetra-n-butyltin, min. 94% (1461-25-2) Sn(C ₄ H ₉) ₄ ; FW: 347.16; colorless liq.; m.p. -97°; b.p. 145°/10 mm; f.p. 225°F; d. 1.0572	50g 250g
50-1800	Tetracyclohexyltin, 99% (1449-55-4) Sn(C ₆ H ₁₁) ₄ ; FW: 451.32; white solid	1g 5g
50-1815 amp HAZ	Tetrakis(dimethylamino)tin(IV), 99% (99.99%-Sn) TDMASn PURATREM (1066-77-9) Sn[N(CH ₃) ₂] ₄ ; FW: 295.01; colorless to pale-yellow liq.; b.p. 51° (15mm); d. 1.169 g/cm ³ <i>moisture sensitive</i> Note: Available prepacked in ALD cylinder- see 98-4050. For detailed technical note visit strem.com .	1g 5g 25g

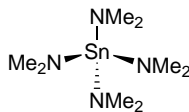

TIN (Compounds)

98-4050 HAZ	Tetrakis(dimethylamino)tin(IV), 99% (99.99%-Sn) TDMASn PURATREM, 50-1815, contained in 50 ml Swagelok® cylinder (96-1070) for CVD/ALD (1066-77-9) Sn[N(CH ₃) ₂] ₄ ; FW: 295.01; colorless to pale-yellow liq.; b.p. 51° (15mm); d. 1.169g/cm ³ <i>moisture sensitive</i>	10g 25g
50-1850	Tetramethyldiacetoxystannoxane (5926-79-4) [(CH ₃) ₂ (CH ₃ CO ₂)Sn] ₂ O; FW: 431.61; white powdr.; m.p. 240° <i>moisture sensitive</i>	1g 5g
50-1900 HAZ 	Tetramethyltin, 98% (594-27-4) Sn(CH ₃) ₄ ; FW: 178.83; colorless liq.; m.p. -54.8°; b.p. 76-78°; f.p. 9°F; d. 1.3149	5g 25g
93-5052	Tetraphenyltin, min. 95% (595-90-4) Sn(C ₆ H ₅) ₄ ; FW: 427.12; white powdr.; m.p. 226°; b.p. > 420°; d. 1.490	100g 500g
50-1950	Tetra-<i>i</i>-propyltin, min. 98% (2949-42-0) Sn(C ₃ H ₇) ₄ ; FW: 291.05; colorless liq.; b.p. 112-114°/18 mm; d. 1.124	2g 10g
93-5053	Tetra-<i>n</i>-propyltin, min. 97% (2176-98-9) Sn(C ₃ H ₇) ₄ ; FW: 291.05; colorless liq.; b.p. 222°; d. 1.1065 (20°)	1g 5g
50-1975	Tin(II) acetate, 99% (638-39-1) Sn(OOCCCH ₃) ₂ ; FW: 236.78; off-white powdr.; m.p. 180°; b.p. subl. 155°/0.1mm	5g 25g
50-1977	Tin(II) acetylacetonate, min. 98% (16009-86-2) Sn(CH ₃ COCHCOCH ₃) ₂ ; FW: 316.93; yellow liq.; b.p. 110°/0.1mm; d. 1.45 <i>moisture sensitive</i>	2g 10g 50g
93-5028 HAZ	Tin(II) bromide, 99% (10031-24-0) SnBr ₂ ; FW: 278.51; gray powdr.; m.p. 232°; b.p. 620°; d. 5.12 <i>moisture sensitive</i>	10g 50g
93-5021 HAZ	Tin(IV) bromide, 99% (7789-67-5) SnBr ₄ ; FW: 438.33; colorless to yellow xtl.; m.p. 31°; b.p. 202°/734 mm; d. 3.34 <i>moisture sensitive</i>	25g 100g
50-2100	Tin(IV) <i>t</i>-butoxide (99.99%-Sn) PURATREM (36809-75-3) Sn(OC ₄ H ₉) ₄ ; FW: 411.17; white solid to turbid colorless liq.; m.p. 45°; b.p. 65°/0.3mm; d. 1.06 <i>moisture sensitive</i>	1g 5g 25g
93-5030 HAZ	Tin(II) chloride, anhydrous, 98% (7772-99-8) SnCl ₂ ; FW: 189.60; white xtl.; m.p. 246.8°; b.p. 623° <i>hygroscopic</i>	100g 500g
93-5031 HAZ	Tin(II) chloride dihydrate, 98% (10025-69-1) SnCl ₂ ·2H ₂ O; FW: 189.60 (225.63); white xtl.; m.p. 37.7°; b.p. dec.; d. 2.710	100g 500g
93-5022 HAZ	Tin(IV) chloride, anhydrous, 98% (7646-78-8) SnCl ₄ ; FW: 260.50; colorless liq.; m.p. -33°; b.p. 114.1°; d. 2.226 <i>moisture sensitive</i>	250g 1kg
50-5022 NEW HAZ	Tin(IV) chloride, anhydrous (99.99-Sn%) PURATREM (7646-78-8) SnCl ₄ ; FW: 260.50; colorless liq.; m.p. -33°; b.p. 114.1°C; d. 2.226 <i>air sensitive, moisture sensitive</i>	5g 25g
93-5023 HAZ	Tin(IV) chloride pentahydrate, 98% (10026-06-9) SnCl ₄ ·5H ₂ O; FW: 260.50 (350.61); off-white lumps	100g 500g
50-2200 amp	Tin(II) ethoxide, min. 99% (14791-99-2) [Sn(C ₂ H ₅ O) ₂] _n ; FW: 208.83; white to off-white powdr.; m.p. 200° dec. <i>moisture sensitive</i>	2g 10g 50g
93-5037	Tin(II) 2-ethylhexanoate, ~90% in 2-ethylhexanoic acid (~28% Sn) (301-10-0) Sn[OOCCH(C ₂ H ₅)C ₄ H ₉] ₂ ; FW: 405.11; viscous liq.; f.p. >287°F	250g 1kg
93-5033 HAZ	Tin(II) fluoride, 97.5% (7783-47-3) SnF ₂ ; FW: 156.69; -40 mesh white powdr.; m.p. 219°; b.p. 850° <i>hygroscopic</i>	50g 250g
93-5024 HAZ	Tin(IV) fluoride, 98.5% (7783-62-2) SnF ₄ ; FW: 194.68; white powdr.; m.p. 705° subl.; d. 4.780 <i>moisture sensitive</i>	1g 5g
50-1980	Tin(II) hexafluoroacetylacetonate (99.9%-Sn) (51319-99-4) Sn(CF ₃ COCHCOCF ₃) ₂ ; FW: 532.81; yellow solid; m.p. 72°; b.p. 125°/2mm	5g 25g

TIN (Compounds)

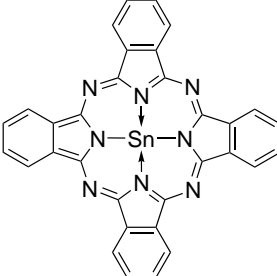
93-5077	Tin(II) iodide, 99% (10294-70-9) SnI ₂ ; FW: 372.50; -6 mesh orange to red powdr.; m.p. 320°; b.p. 720°; d. 5.21 <i>moisture sensitive</i>	5g 25g
93-5025 HAZ	Tin(IV) iodide, 95% (7790-47-8) SnI ₄ ; FW: 626.31; orange xtl.; m.p. 144.5°; b.p. 364.5°; d. 4.473 <i>moisture sensitive</i>	10g 50g
93-5038	Tin(II) oxalate (814-94-8) SnC ₂ O ₄ ; FW: 206.72; white powdr.; m.p. 280° dec.; d. 3.56	50g 250g
93-5039	Tin(II) oxide, 98% (99+% -Sn) (21651-19-4) SnO; FW: 134.69; gray powdr.; m.p. dec.; d. 6.95	50g 250g
93-5026	Tin(IV) oxide (99.9%-Sn) (18282-10-5) SnO ₂ ; FW: 150.69; white powdr.; m.p. 1630°; d. 7.0	100g 500g
50-2500	Tin(IV) oxide (99.998%-Sn) PURATREM (18282-10-5) SnO ₂ ; FW: 150.69; -22 mesh off-white powdr.; m.p. 1630°; d. 7.0	5g 25g
50-0518	Tin(IV) oxide, nanoparticle (30-60 nm), (99.7%-Sn) (18282-10-5) See page 166	
93-5072	Tin(II) phthalocyanine (15304-57-1) (C ₃₂ H ₁₆ N ₈)Sn; FW: 631.24; purple powdr.	250mg 1g
		
93-5012	Tin(IV) phthalocyanine dichloride (18253-54-8) (C ₃₂ H ₁₆ N ₈)SnCl ₂ ; FW: 702.15; purple powdr. <i>moisture sensitive</i>	1g 5g
93-5044	Tin(II) sulfate, 95+% (7488-55-3) SnSO ₄ ; FW: 214.75; white powdr.; m.p. > 360°	100g 500g
93-5046	Tin(II) tartrate hydrate, min. 95% (815-85-0) SnC ₄ H ₄ O ₆ ·XH ₂ O; FW: 266.76; off-white powdr.	5g 25g
50-2750	Tin(II) trifluoromethanesulfonate, 99% (Tin triflate) (62086-04-8) Sn(CF ₃ SO ₃) ₂ ; FW: 416.82; white powdr.; m.p. dec. <i>hygroscopic</i>	2g 10g
50-3015 HAZ	Tributyl(1-ethoxyvinyl)tin, 97% (97674-02-7) (C ₄ H ₉) ₃ Sn(C ₄ H ₇ O); FW: 361.16; colorless liq. For detailed technical note visit strem.com .	1g 5g 25g
93-5054 HAZ	Tri-n-butyltin acetate, 98% (56-36-0) (C ₄ H ₉) ₃ SnOOCCH ₃ ; FW: 349.08; white powdr.; m.p. 87°; d. 1.27 <i>moisture sensitive</i>	100g 500g
93-5056 HAZ	Tri-n-butyltin chloride, 96% (1461-22-9) (C ₄ H ₉) ₃ SnCl; FW: 325.49; colorless liq.; b.p. 172°/5 mm; f.p. 210°F; d. 1.207 (20°) <i>moisture sensitive</i>	50g 250g
93-5081 HAZ	Tri-n-butyltin hydride, min. 95% (688-73-3) (C ₄ H ₉) ₃ SnH; FW: 291.04; colorless liq.; b.p. 78°/0.8 mm; f.p. 104°F; d. 1.103 (20°) <i>air sensitive, (store cold)</i>	25g 100g
50-3000 HAZ	Triethyltin bromide, min. 97% (2767-54-6) (C ₂ H ₅) ₃ SnBr; FW: 285.78; colorless liq.; m.p. -13.5°; b.p. 73-74°/2.9 mm; f.p. 211°F; d. 1.630 <i>moisture sensitive</i>	1g 5g
50-3008 HAZ	Triethyltin chloride, 98% (994-31-0) (C ₂ H ₅) ₃ SnCl; FW: 241.33; colorless liq.; m.p. 15.5°; b.p. 206°; d. 1.429 <i>moisture sensitive</i>	5g 25g

TIN (Compounds)

50-3500 HAZ	Trimethyltin bromide, min. 97% (1066-44-0) (CH ₃) ₃ SnBr; FW: 243.70; white xtl.; m.p. 27°; b.p. 61°/13 mm <i>moisture sensitive</i>	2g 10g
93-5084 HAZ	Trimethyltin chloride, min. 98% (1066-45-1) (CH ₃) ₃ SnCl; FW: 199.25; white xtl.; m.p. 37°; b.p. 154°; f.p. 207°F <i>moisture sensitive, (store cold)</i>	5g 25g
93-5085	Trimethyltin hydroxide, 98% (56-24-6) (CH ₃) ₃ SnOH; FW: 180.80; white powdr.; m.p. 118°; b.p. 80° subl. <i>air sensitive</i>	2g 10g 50g
93-5059 HAZ	Triphenyltin acetate, 97% (900-95-8) (C ₆ H ₅) ₃ SnOOCCH ₃ ; FW: 409.05; white powdr.; m.p. 123°	25g 100g
93-5060 HAZ	Triphenyltin chloride, min. 95% (639-58-7) (C ₆ H ₅) ₃ SnCl; FW: 385.46; white powdr.; m.p. 106°; b.p. 249°/13.5 mm <i>moisture sensitive</i>	50g 250g
93-5061	Triphenyltin fluoride, min. 97% (379-52-2) (C ₆ H ₅) ₃ SnF; FW: 368.99; white powdr. <i>moisture sensitive</i>	5g 25g
50-4200 HAZ	Tri-i-propyltin chloride, min. 98% (14101-95-2) (C ₃ H ₇) ₃ SnCl; FW: 283.43; colorless liq.	1g 5g
93-5063 HAZ	Tri-n-propyltin chloride, 98+% (2279-76-7) (C ₃ H ₇) ₃ SnCl; FW: 283.41; colorless liq.; m.p. -23.5°; b.p. 123°/13 mm; d. 1.2678 (28°) <i>moisture sensitive</i>	5g 25g

TITANIUM (Elemental Forms)

22-0175	Titanium crystals (99.99+%) (7440-32-6) Ti; FW: 47.90; irregular needles; m.p. 1660°; d. 4.5	10g 50g
93-2244	Titanium foil (99.6+%) (7440-32-6) Ti; FW: 47.90; 0.025 mm thick x 100 mm wide; d. 4.5	100 x 100mm 500 x 100mm
22-0151	Titanium foil (99.7%) (7440-32-6) Ti; FW: 47.90; 0.127mm thick x 170mm wide; m.p. 1660°; d. 4.5	170 x 170mm 500 x 170mm
	Titanium nanoparticles - surfactant and reactant-free (pure), manufactured via laser ablation (7440-32-6) See page 167	
93-2267 HAZ	Titanium powder (99%) (7440-32-6) Ti; FW: 47.90; -325 mesh; d. 4.5 <i>pyrophoric</i>	50g 250g
22-0160 HAZ	Titanium powder (99.4%) (7440-32-6) Ti; FW: 47.90; -150 mesh; m.p. 1660°; d. 4.5 <i>pyrophoric</i>	50g 250g
93-2260 HAZ	Titanium powder (99.7%) (7440-32-6) Ti; FW: 47.90; -100 mesh; d. 4.5 <i>pyrophoric</i>	25g 100g 500g
93-2269	Titanium rod (99.5%) (7440-32-6) Ti; FW: 47.90; 6.4 mm dia (~1.5g/cm); d. 4.5	10cm 50cm
93-2270	Titanium rod (99.5%) (7440-32-6) Ti; FW: 47.90; 3.2 mm dia (~0.4g/cm); d. 4.5	10cm 50cm
93-2243 HAZ	Titanium sponge (99.5%) (7440-32-6) Ti; FW: 47.90; random pieces; d. 4.5	100g 500g
93-2268 HAZ	Titanium sponge, crystals (99.8%) (7440-32-6) Ti; FW: 47.90; 5-10mm pieces; d. 4.5	100g 500g
93-2254	Titanium wire (99.7%) (7440-32-6) Ti; FW: 47.90; 0.65 mm dia.; d. 4.5	2.5m 10m
93-2253	Titanium wire (99.7%) (7440-32-6) Ti; FW: 47.90; 0.5 mm dia.; d. 4.5	2.5m 10m
93-2252	Titanium wire (99.7%) (7440-32-6) Ti; FW: 47.90; 0.37 mm dia.; d. 4.5	10m 50m
93-2256	Titanium wire (99.97%) (7440-32-6) Ti; FW: 47.90; 0.75 mm dia.; d. 4.5	25cm 100cm

TITANIUM (Elemental Forms)

93-2250	Titanium wire (99.97%) (7440-32-6) Ti; FW: 47.90; 0.25 mm dia.; d. 4.5	50cm 250cm
93-2249	Titanium wire (99.97%) (7440-32-6) Ti; FW: 47.90; 0.127 mm dia.; d. 4.5	1m 5m
93-2255	Titanium wire (99.99%) (7440-32-6) Ti; FW: 47.90; 0.5 mm dia. (~0.45g/50 cm); d. 4.5	50cm 250cm

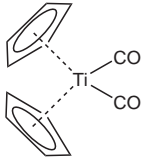
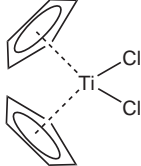
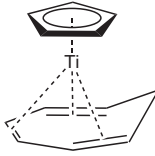

TITANIUM (Compounds)

22-0170	Bis(t-butylcyclopentadienyl)titanium dichloride, min. 98% (79269-71-9) [(C ₄ H ₉)C ₅ H ₄] ₂ TiCl ₂ ; FW: 361.19; red xtl. <i>moisture sensitive</i>	1g 5g 25g
22-0180 amp HAZ	Bis(cyclopentadienyl)dicarbonyl titanium(II), min. 98% (12129-51-0) (C ₅ H ₅) ₂ Ti(CO) ₂ ; FW: 234.09; red xtl. <i>air sensitive</i> For detailed technical note visit strem.com .	1g 5g
		
22-0200	Bis(cyclopentadienyl)titanium dichloride, 99+% (Titanocene dichloride) (1271-19-8) (C ₅ H ₅) ₂ TiCl ₂ ; FW: 249.00; red xtl.; m.p. 289-291° <i>air sensitive, moisture sensitive</i> For detailed technical note visit strem.com .	25g 100g
		
22-0250	Bis(ethylcyclopentadienyl)titanium(IV) dichloride, min. 98% (35625-75-3) [(C ₂ H ₅)C ₅ H ₄] ₂ TiCl ₂ ; FW: 305.08; red-brown xtl. <i>moisture sensitive</i>	1g 5g
22-0300	Bis(pentamethylcyclopentadienyl)titanium dichloride, 99% (11136-36-0) [(CH ₃) ₅ C ₅] ₂ TiCl ₂ ; FW: 389.23; red-brown xtl. <i>moisture sensitive</i>	1g 5g
22-0320	Bis(i-propylcyclopentadienyl)titanium dichloride, min. 98% (12130-65-3) [(C ₃ H ₇)C ₅ H ₄] ₂ TiCl ₂ ; FW: 333.14; red xtl. <i>moisture sensitive</i>	1g 5g
22-0340	Bis(2,2,6,6-tetramethyl-3,5-heptanedionato)oxotitanium(IV), min. 95% [OTi(TMHD) ₂] (152248-67-4) OTi(C ₁₁ H ₁₉ O ₂) ₂ ; FW: 430.42; off-white powdr.; m.p. 120° dec.	500mg 2g 10g
22-0380 HAZ	Chlorotitanium triisopropoxide, 97% (20717-86-6) TiCl(OC ₃ H ₇) ₃ ; FW: 260.62; fused solid to pale yellow liq.; m.p. 35-40°; f.p. 72°F; d. 1.091 <i>moisture sensitive</i>	25g 100g
22-0450 HAZ	Cyclopentadienyl(cycloheptatrienyl)titanium(II), 99% (51203-49-7) Ti(C ₅ H ₅)(C ₇ H ₇); FW: 204.09; blue xtl. <i>air sensitive</i> Note: CVD Precursor.	500mg 2g
		
22-0400 HAZ	Cyclopentadienyltitanium trichloride, 99% (1270-98-0) C ₅ H ₅ TiCl ₃ ; FW: 219.35; yellow xtl.; m.p. 198-200° <i>moisture sensitive</i>	1g 5g 25g
22-0600	Dichlorobis(2,2,6,6-tetramethyl-3,5-heptanedionato)titanium(IV), 99% (53293-32-6) (C ₁₁ H ₁₉ O ₂) ₂ TiCl ₂ ; FW: 485.33; orange xtl.; m.p. 127-129°; b.p. dec. 215° <i>moisture sensitive</i>	1g 5g 25g
22-0700	Dimethylbis(t-butylcyclopentadienyl)titanium(IV), min. 98% (79376-38-8) [(C ₄ H ₉)C ₅ H ₄] ₂ Ti(CH ₃) ₂ ; FW: 320.35; yellow-orange powdr. <i>air sensitive, moisture sensitive</i>	1g 5g 25g

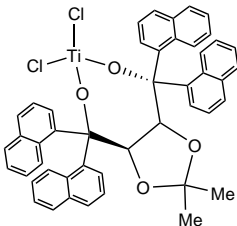
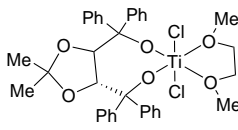
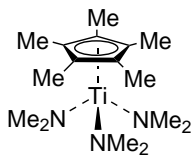
TITANIUM (Compounds)

22-0761	(4R,5R)-(-)-2,2-Dimethyl- $\alpha,\alpha,\alpha',\alpha'$ -tetra(1-naphthyl)-1,3-dioxolane-4,5-dimethanolatotitanium(IV) dichloride acetonitrile adduct (197389-47-2) [C ₄₇ H ₃₆ O ₄] ₂ TiCl ₂ ·CH ₃ CN; FW: 783.58 (824.63); yellow powdr. <i>air sensitive, moisture sensitive</i> For detailed technical note visit strem.com .		250mg 1g
22-0780	(4R,5R)-(-)-2,2-Dimethyl- $\alpha,\alpha,\alpha',\alpha'$ -tetraphenyl-1,3-dioxolane-4,5-dimethanolato[1,2-bis(dimethoxy)ethane]titanium(IV) dichloride acetonitrile adduct (328123-04-2) [C ₃₇ H ₂₈ O ₄] ₂ [C ₄ H ₁₀ O ₂] ₂ TiCl ₂ ·CH ₃ CN; FW: 673.45 (714.50); white xtl. <i>air sensitive, moisture sensitive</i> For detailed technical note visit strem.com .		250mg 1g
22-0800	Di(i-propoxide)bis(2,2,6,6-tetramethyl-3,5-heptanedionato)titanium(IV), min. 98% (144665-26-9) (C ₁₁ H ₁₈ O ₂) ₂ (C ₃ H ₇ O) ₂ Ti; FW: 532.60; white powdr. <i>moisture sensitive</i>		1g 5g 25g
93-2230 HAZ	Hexafluorotitanic acid, 60% aqueous solution (17439-11-1) H ₂ TiF ₆ ; FW: 163.91; colorless liq.		500g 2 x 1kg
22-0900 HAZ	Hydrotris(pyrazol-1-ylborato)trichlorotitanium(IV), min. 95% (58097-69-1) C ₉ H ₁₀ BCl ₃ N ₆ Ti; FW: 367.27; yellow to orange powdr. <i>moisture sensitive</i>		250mg 1g
22-0950 amp HAZ	Indenyltitanium trichloride, 99% (84365-55-9) C ₉ H ₇ TiCl ₃ ; FW: 269.39; purple xtl. <i>air sensitive, moisture sensitive</i>		1g 5g 25g
22-1075 HAZ	Pentamethylcyclopentadienyltitanium trichloride, 98% (12129-06-5) (C ₅ (CH ₃) ₅)TiCl ₃ ; FW: 289.47; red xtl.; m.p. 225° <i>moisture sensitive</i>		1g 5g
22-1078 amp	Pentamethylcyclopentadienyltitanium trimethoxide, min. 97% (123927-75-3) [C ₅ (CH ₃) ₅ Ti(OCH ₃) ₃]; FW: 276.21; yellow liq.; d. 1.081 <i>moisture sensitive</i>		1g 5g
22-6015 HAZ	Pentamethylcyclopentadienyltris(dimethylamino)titanium(IV), 99% (154940-96-2) [(CH ₃) ₅ C ₅]Ti[N(CH ₃) ₂] ₃ ; FW: 315.32; red xtl. <i>moisture sensitive</i> For detailed technical note visit strem.com .		250mg 1g 5g
22-1080 HAZ	Tetrachlorobis(tetrahydrofuran)titanium(IV), min. 97% (31011-57-1) TiCl ₄ (C ₄ H ₈ O) ₂ ; FW: 333.91; yellow xtl.; m.p. 126-128° <i>moisture sensitive</i>		5g 25g 100g
22-1050 amp HAZ	Tetrakis(diethylamino)titanium(IV), 99% (4419-47-0) Ti[N(C ₂ H ₅) ₂] ₄ ; FW: 336.40; yellow to orange liq.; b.p. 133°/1.2mm; f.p. -18°F; d. 0.938 <i>moisture sensitive</i> Note: Available prepacked in ALD cylinder- see 98-4043.		5g 25g
98-4043 HAZ	Tetrakis(diethylamino)titanium(IV), 99%, 22-1050, contained in 50 ml Swagelok® cylinder (96-1070) for CVD/ALD (4419-47-0) Ti[N(C ₂ H ₅) ₂] ₄ ; FW: 336.40; yellow to orange liq.; b.p. 133°/1.2mm; f.p. -18°F; d. 0.938 <i>moisture sensitive</i> Note: High temperature Swagelok® cylinder assembly 96-1071 available at extra cost.		10g 25g

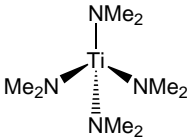
TITANIUM (Compounds)

93-2240 amp HAZ	Tetrakis(dimethylamino)titanium(IV), 99% TDMAT (3275-24-9) $Ti[N(CH_3)_2]_4$; FW: 224.20; yellow to orange liq.; b.p. 50°/0.5 mm; f.p. -22°F; d. 0.96 <i>moisture sensitive</i> Note: Available prepacked in ALD cylinder- see 98-4015, 98-4016.		1g 5g 25g
22-2240 NEW HAZ	Tetrakis(dimethylamino)titanium(IV), 99% TDMAT (99.99%-Ti) PURATREM (3275-24-9) $Ti[N(CH_3)_2]_4$; FW: 224.20; yellow to orange liq.; f.p. -22°F <i>air sensitive, moisture sensitive</i>		1g 5g 25g
98-4015 HAZ	Tetrakis(dimethylamino)titanium(IV), 99% TDMAT, 93-2240, contained in 50 ml Swagelok® cylinder (96-1070) for CVD/ALD (3275-24-9) $Ti[N(CH_3)_2]_4$; FW: 224.20; yellow to orange liq.; b.p. 50°/0.5 mm; f.p. -22°F; d. 0.96 <i>moisture sensitive</i> Note: High temperature Swagelok® cylinder assembly 96-1071 available at extra cost. See 98-4016.		25g
98-4016 HAZ	Tetrakis(dimethylamino)titanium(IV), 99% TDMAT, 93-2240, contained in high-temp 50 ml Swagelok® cylinder (96-1071) for CVD/ALD (3275-24-9) $Ti[N(CH_3)_2]_4$; FW: 224.20; yellow to orange liq.; b.p. 50°/0.5 mm; f.p. -22°F; d. 0.96 <i>moisture sensitive</i>		25g
22-1060 NEW amp HAZ	Tetrakis(ethylmethylamino)titanium, 99% (99.99%-Ti) PURATREM (308103-54-0) $C_{12}H_{32}N_4Ti$; FW: 280.28; yellow to orange liq. <i>moisture sensitive</i>		2g 10g
93-2242	Titanium boride, 99% (12045-63-5) TiB_2 ; FW: 69.52; gray powdr.; m.p. 2900°; d. 4.50		25g 100g
22-1175 NEW	Titanium boride, hexagonal crystalline solid, 0.7-10.0 microns, 99% (12045-63-5) TiB_2 ; FW: 69.52; dark-gray solid		50g 250g
93-2221 HAZ	Titanium(IV) bromide, min. 98% (7789-68-6) $TiBr_4$; FW: 367.54; orange xtl.; m.p. 39°; b.p. 230°; d. 2.6 <i>moisture sensitive</i>		5g 25g 100g
93-2204	Titanium(IV) n-butoxide, 98+% (5593-70-4) $Ti(OC_4H_9)_4$; FW: 340.35; colorless liq.; m.p. -55°; b.p. 312° (206°/10mm); f.p. 170°F; d. 0.994 (25°) <i>moisture sensitive</i>		500g 2kg
22-1170	Titanium(IV) t-butoxide (99.95%-Ti) (3087-39-6) $Ti(OC_4H_9)_4$; FW: 340.35; colorless liq.; b.p. 70°/0.2mm; d. 0.89 <i>moisture sensitive</i>		5g 25g
93-2205	Titanium carbide, 99% (12070-08-5) TiC ; FW: 59.91; 2 micron gray powdr.; m.p. ~3140°; b.p. 4820°; d. 4.93		100g 500g
22-1180 HAZ	Titanium(III) chloride, Al reduced, 98+% (12003-13-3) $TiCl_3 \cdot 1/3AlCl_3$; FW: 198.72; purple xtl. <i>air sensitive, moisture sensitive</i>		100g 500g
22-1150 HAZ 	Titanium(IV) chloride, 99% (7550-45-0) $TiCl_4$; FW: 189.73; pale yellow liq.; m.p. -25°; b.p. 136°; d. 1.726 <i>moisture sensitive</i> Note: Available prepacked in ALD cylinder- see 98-4033.		250g 1kg
98-4033 HAZ 	Titanium(IV) chloride, 99%, 22-1150, contained in 50 ml Swagelok® cylinder (96-1070) for CVD/ALD (7550-45-0) $TiCl_4$; FW: 189.73; pale yellow liq.; m.p. -25°; b.p. 136°; d. 1.726 <i>moisture sensitive</i> Note: High temperature Swagelok® cylinder assembly 96-1071 available at extra cost.		25g
93-2203 HAZ	Titanium (di-i-propoxide)bis(acetylacetonate) (75% in isopropanol) (17927-72-9) $Ti(OC_3H_7)_2(CH_3COCHCOCH_3)_2$; FW: 364.27; orange liq.; f.p. 72°F (isopropanol); d. 0.995 <i>moisture sensitive</i>		500g

TITANIUM (Compounds)

22-2222	Titanium(IV) (di-i-propoxide)bis[BREW] (99.99+%Ti) PURATREM Ti(OC ₃ H ₇) ₂ [C·HyC(O)CHC(O)C·Hy] ₂ (x=3-4, y=2x + 1); red-orange liq. <i>moisture sensitive</i> Note: 8-11 wt% Ti, ***Limited quantities available. Will discontinue when stock gone***	1g 5g
93-2209 HAZ	Titanium(IV) ethoxide (contains 5-15% isopropanol) (3087-36-3) Ti(OC ₂ H ₅) ₄ ; FW: 228.14; colorless liq.; b.p. 122°/1 mm; f.p. 84°F; d. 1.107 (20°) <i>moisture sensitive</i>	25g 100g 500g
22-2209 amp HAZ	Titanium(IV) ethoxide (99.99%-Ti) PURATREM (3087-36-3) Ti(OC ₂ H ₅) ₄ ; FW: 228.14; xtl. to pale orange liq.; m.p. 54°; b.p. 138°/5mm; f.p. 84°F; d. 1.088 <i>moisture sensitive</i>	5g 25g
93-2224 HAZ	Titanium(III) fluoride, min. 98% (13470-08-1) TiF ₃ ; FW: 104.90; purplish-brown powdr.; m.p. 1200°; b.p. 1400°; d. 3.40 <i>moisture sensitive</i>	5g 25g
93-2222 HAZ	Titanium(IV) fluoride, 98% (7783-63-3) TiF ₄ ; FW: 123.89; white powdr.; m.p. > 400°; b.p. 284° subl.; d. 2.798 <i>moisture sensitive</i>	10g 50g
93-2211 HAZ	Titanium(II) hydride, min. 95% (99+%Ti) (7704-98-5) TiH ₂ ; FW: 49.92; -325 mesh gray powdr.; m.p. 450° (dec.); d. 3.9 <i>air sensitive, moisture sensitive</i>	25g 100g 500g
93-2223 HAZ	Titanium(IV) iodide (99.99%-Ti) PURATREM (7720-83-4) TiI ₄ ; FW: 555.52; black xtl.; m.p. 150°; b.p. 377.1°; d. 4.3 <i>moisture sensitive</i>	1g 5g
93-2213	Titanium nitride (99+%Ti) (25583-20-4) TiN; FW: 61.91; -325 mesh gray powdr.; m.p. 2930°; d. 5.22	25g 100g
22-1190 NEW	Titanium nitride, 1.3-1.9 microns (99+%Ti) (25583-20-4) TiN; FW: 61.91; gray powdr.; m.p. 2930°; d. 5.22	100g 500g
93-2212	Titanium(II) oxide, optical grade, pellets (99.9+%Ti) (12137-20-1) TiO; FW: 63.90; bronze pellets (~1g/pellet); m.p. 1700°; b.p. > 3000°; d. 4.95	5g 25g 100g
93-2206	Titanium(IV) oxide, 99+% (13463-67-7) TiO ₂ ; FW: 79.90; 1.0-1.3 micron white powdr.; m.p. 1830-1850°; b.p. 2500-3000°; d. 4.26	250g 1kg
93-2207	Titanium(IV) oxide (99.99+%Ti) PURATREM (13463-67-7) TiO ₂ ; FW: 79.90; white powdr.; m.p. 1830-1850°; b.p. 2500-3000°; d. 4.26	25g 100g
93-2225	Titanium(IV) oxide bis(acetylacetonate), min. 95% (14024-64-7) TiO(CH ₃ COCHCOCH ₃) ₂ ; FW: 262.12; yellow powdr.; m.p. 184° dec.	5g 25g 100g
22-1400	Titanium(IV) oxide nanopowder Anatase (1317-80-2) See page 167	
93-2208	Titanium(IV) oxide, sintered lumps, 99.5% (13463-67-7) TiO ₂ ; FW: 79.90; white lump; m.p. 1830-1850°; b.p. 2500-3000°; d. 4.26	25g 100g
93-2216 HAZ	Titanium(IV) i-propoxide, min. 98% (546-68-9) Ti[OCH(CH ₃) ₂] ₄ ; FW: 284.25; colorless to pale yellow liq.; m.p. 20°; b.p. 58°/1 mm; f.p. 81°F; d. 0.9550 <i>moisture sensitive</i> Note: Available prepacked in ALD cylinder- see 98-4030. For detailed technical note visit strem.com .	250g 1kg
98-4030 HAZ	Titanium(IV) i-propoxide, min. 98%, 93-2216, contained in 50 ml Swagelok® cylinder (96-1070) for CVD/ALD (546-68-9) Ti[OCH(CH ₃) ₂] ₄ ; FW: 284.25; colorless liq.; m.p. 20°; b.p. 58°/1mm; f.p. 81°F; d. 0.9550 <i>moisture sensitive</i> Note: High temperature Swagelok® cylinder assembly 96-1071 available at extra cost.	25g
93-2218	Titanium silicide (99+%Ti) (12039-83-7) TiSi ₂ ; FW: 104.03; -325 mesh gray to black powdr.; m.p. 1540°; d. 4.39	25g 100g
93-2220 HAZ	Titanium(IV) sulfide (99.8%-Ti) (12039-13-3) TiS ₂ ; FW: 112.03; -200 mesh yellow to brown powdr.; d. 3.22 <i>moisture sensitive</i>	1g 5g 25g

TITANIUM (Compounds)

22-3500	Trichlorotris(tetrahydrofuran)titanium(III), min. 97% (18039-90-2)	5g
amp	TiCl ₃ (C ₄ H ₈ O) ₃ ; FW: 370.56; pale blue xtl.	25g
HAZ	air sensitive, moisture sensitive	100g
22-5500	(Trimethyl)pentamethylcyclopentadienyltitanium(IV), min. 97% (107333-47-1)	250mg
amp	(CH ₃) ₅ C ₅ Ti(CH ₃) ₃ ; FW: 228.22; yellow xtl.	1g
HAZ	air sensitive, light sensitive, moisture sensitive, (store cold)	5g
22-6000	Tris(2,2,6,6-tetramethyl-3,5-heptanedionato)titanium(III), min. 97% [Ti(TMHD)₃] (181418-64-4)	1g
amp	Ti(C ₁₁ H ₁₉ O ₂) ₃ ; FW: 597.70; purple xtl.; b.p. subl. 75°/0.1mm	5g
	air sensitive, moisture sensitive	25g

TUNGSTEN (Elemental Forms)

93-7456	Tungsten powder (99.9%) (7440-33-7)	50g
HAZ	W; FW: 183.85; 12 micron; m.p. 3410°; b.p. 5660°; d. 19.3	250g
93-7455	Tungsten powder (99.9+%) (7440-33-7)	50g
HAZ	W; FW: 183.85; -100 mesh; m.p. 3410°; b.p. 5660°; d. 19.3	250g
93-7437	Tungsten powder (99.95%) (7440-33-7)	50g
HAZ	W; FW: 183.85; 0.6-0.9 microns; m.p. 3410°; b.p. 5660°; d. 19.3	250g
74-0075	Tungsten rod annealed (99.98%) (7440-33-7)	25cm
	W; FW: 183.85; 3.175mm dia. (~1.53g/cm); m.p. 3410°; b.p. 5660°; d. 19.3	100cm
		5 x 100cm
93-7450	Tungsten wire (99.95%) (7440-33-7)	5m
	W; FW: 183.85; 0.5 mm dia.; m.p. 3410°; b.p. 5660°; d. 19.3	25m
93-7452	Tungsten wire (99.95%) (7440-33-7)	20m
	W; FW: 183.85; 0.2 mm dia.; m.p. 3410°; b.p. 5660°; d. 19.3	100m
93-7438	Tungsten wire (99.95%) (7440-33-7)	50m
	W; FW: 183.85; 0.127 mm dia.; m.p. 3410°; b.p. 5660°; d. 19.3	250m
93-7439	Tungsten wire (99.95%) (7440-33-7)	100m
	W; FW: 183.85; 0.05 mm dia.; m.p. 3410°; b.p. 5660°; d. 19.3	
93-7451	Tungsten wire (99.95%) (7440-33-7)	100m
	W; FW: 183.85; 0.025 mm dia.; m.p. 3410°; b.p. 5660°; d. 19.3	500m

TUNGSTEN (Compounds)

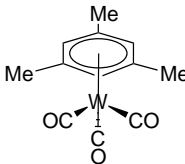
74-1000	Ammonium tetrathiotungstate(VI), 99% (99.9+%-W) (13862-78-7)	
	See page 7	
74-1910	Bis(acetonitrile)tetracarbonyltungsten(0) (16800-45-6)	1g
NEW	C ₈ H ₁₆ N ₂ O ₄ W; FW: 377.98; yellow solid	5g
	air sensitive	
74-1225	Bis(t-butylimido)bis(dimethylamino)tungsten(VI), min. 97% BTBMW (406462-43-9)	1g
	C ₁₂ H ₃₀ N ₄ W; FW: 414.23; yellow liq.; b.p. 81°C (0.02mm); d. 1.305	5g
	air sensitive, moisture sensitive	
	For detailed technical note visit strem.com .	
74-1200	Bis(cyclopentadienyl)tungsten dichloride, 99% (12184-26-8)	1g
amp	(C ₅ H ₅) ₂ WCl ₂ ; FW: 384.94; green powdr.	5g
	moisture sensitive	
74-1350	Mesitylene tungsten tricarbonyl, 98% (12129-69-0)	1g
	C ₉ H ₁₂ W(CO) ₃ ; FW: 388.08; yellow xtl.; m.p. 165° dec.	5g
		
93-7422	Sodium tungstate dihydrate, 99+% (ACS) (10213-10-2)	
	See page 421	

TUNGSTEN (Compounds)

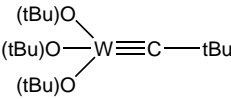
74-1800 amp	Tris(t-butoxy)(2,2-dimethylpropylidene)tungsten(VI), 98% Schrock Alkyne Metathesis Catalyst (78234-36-3) (C ₄ H ₉ O) ₃ W≡C(CH ₃) ₂ ; FW: 472.31; off-white to tan powdr. <i>air sensitive, moisture sensitive, (store cold)</i> For detailed technical note visit strem.com .		100mg 500mg
74-2000	Tungsten boride (99.5%-W) (WB) (12007-09-9) WB; FW: 194.66; -325 mesh black powdr. (10 micron or less avg. particle size)		10g 50g
93-7431	Tungsten carbide (99.5%-W) (12070-12-1) WC; FW: 195.86; <1 micron gray powdr.; m.p. ~2870°; b.p. 6000°; d. 15.63		50g 250g
74-2201	Tungsten carbonyl, 99% (<0.1%-Mo) (14040-11-0) W(CO) ₆ ; FW: 351.92; white to off-white powdr.; m.p. 169-170° dec.		5g 25g
74-2200	Tungsten carbonyl, 99% (<0.3%-Mo) (14040-11-0) W(CO) ₆ ; FW: 351.92; white xtl.; m.p. 169-170° dec. For detailed technical note visit strem.com .		5g 25g 100g
74-2202	Tungsten carbonyl, 99% (99.9+%-W) sublimed (14040-11-0) W(CO) ₆ ; FW: 351.92; white xtl.; m.p. 169-170° dec.		5g 25g
74-2348 amp HAZ	Tungsten(IV) chloride, 97% (13470-13-8) WCl ₄ ; FW: 325.66; gray powdr.; d. 4.624 <i>moisture sensitive</i>		5g 25g
74-2350 amp HAZ	Tungsten(VI) chloride (99.9%-W) (13283-01-7) WCl ₆ ; FW: 396.57; purple xtl.; m.p. 275°; b.p. 346.7° <i>moisture sensitive</i>		25g 100g 5 x 100g
74-7430	Tungsten(IV) oxide (99.9%-W) (12036-22-5) WO ₂ ; FW: 215.85; brown powdr.; m.p. 1500-1600°; d. 12.11		10g 50g
74-7435	Tungsten(IV) oxide (99.9+%-W) (WO₂.9 Blue Sub-oxide) (12037-58-0) WO _{2.75-2.90} ; FW: 215.85; blue powdr.		10g 50g
93-7427	Tungsten(VI) oxide (min. 99.8%-W) (1314-35-8) WO ₃ ; FW: 231.85; yellowish-green powdr.; m.p. 1473°; d. 7.16		100g 500g
74-3105	Tungsten(VI) oxide (99.995%-W) PURATREM (1314-35-8) WO ₃ ; FW: 231.85; yellow powdr.; m.p. 1473°; d. 7.16		10g 50g
93-7411	Tungsten(VI) oxide, sintered lumps (99.99%-W) PURATREM (1314-35-8) WO ₃ ; FW: 231.85; yellowish-green pieces; m.p. 1473°; d. 7.16		10g 50g
74-3180 NEW	Tungsten(VI) oxychloride, 98% (13520-78-0) WOCl ₄ ; FW: 341.65; orange needles <i>air sensitive, moisture sensitive</i>		1g 5g 25g
93-7424	Tungsten(IV) sulfide (99.5%-W) (12138-09-9) WS ₂ ; FW: 247.98; black powdr.; m.p. 1250° dec.; d. 7.5		50g 250g
93-7410	Tungstic acid, 99% (7783-03-1) H ₂ WO ₄ ; FW: 249.86; yellow powdr.; m.p. 100° dec.; d. 5.5		50g 250g
93-7402 HAZ	12-Tungstophosphoric acid hydrate, 99+% (12501-23-4) H ₃ [PW ₁₂ O ₄₀] _n ·XH ₂ O; FW: 2880.20; white xtl. <i>hygroscopic</i>		25g 100g 500g

VANADIUM (Elemental Forms)

23-0050	Vanadium foil (99.5%) (7440-62-2) V; FW: 50.94; 0.127mm thick (~3.87g/50x100mm); m.p. 1717°; b.p. 3000°; d. 6.11	50 x 100mm 100 x 200mm
93-2340	Vanadium powder (99.5%) (7440-62-2) V; FW: 50.94; -20 mesh; m.p. 1717°; b.p. 3000°; d. 6.11	5g 25g
93-2341	Vanadium powder (99.5%) (7440-62-2) V; FW: 50.94; -325 mesh; m.p. 1717°; b.p. 3000°; d. 6.11	5g 25g
23-0080	Vanadium rod (99.5%) (7440-62-2) V; FW: 50.94; 12.7mm dia. (~7.74g/cm); m.p. 1717°; b.p. 3000°; d. 6.11	2cm 10cm
93-2343	Vanadium slugs (99.9%) (7440-62-2) V; FW: 50.94; 6.35 mm x 12.7 mm; m.p. 1717°; b.p. 3000°; d. 6.11	5g 25g
93-2344	Vanadium turnings (99.7%) (7440-62-2) V; FW: 50.94; 2.54 cm and down; m.p. 1717°; b.p. 3000°; d. 6.11	5g 25g

VANADIUM (Compounds)

23-0200 HAZ	Bis(cyclopentadienyl)vanadium dichloride (Vanadocene dichloride), 95% (12083-48-6) $(C_5H_5)_2VCl_2$; FW: 252.04; green xtl.; m.p. 250° dec.; d. 1.60 <i>moisture sensitive, (store cold)</i>	1g 5g 25g
23-0180 amp HAZ	Bis(cyclopentadienyl)vanadium, sublimed, 95% (Vanadocene) (1277-47-0) $(C_5H_5)_2V$; FW: 181.13; purple xtl.; b.p. (subl. 200°/0.1mm) <i>air sensitive, moisture sensitive</i>	1g 5g
23-0350 amp	Cyclopentadienylvanadium tetracarbonyl, min. 97% (12108-04-2) $C_5H_5V(CO)_4$; FW: 228.08; orange to red xtl.; m.p. 138°; b.p. (subl. 80-110°/0.1mm) <i>air sensitive, (store cold)</i>	1g 5g
96-6770	PhosphonicS Metal Oxidation Catalyst Kit See page 488	
23-0515 NEW HAZ	Tetrakis(diethylamino)vanadium(IV), min. 95% TDEAV (219852-96-7) $V[N(CH_2CH_3)_2]_4$; FW: 339.46; green liq. <i>air sensitive, moisture sensitive, (store cold)</i>	250mg 1g 5g
23-0500 HAZ	Tetrakis(dimethylamino)vanadium(IV), min. 95% TDMAV (19824-56-7) $V[N(CH_3)_2]_4$; FW: 227.25; dark solid; m.p. 55-60° <i>air sensitive, moisture sensitive, (store cold)</i> For detailed technical note visit strem.com .	250mg 1g 5g
23-0365 NEW	Tetrakis(ethylmethylamino)vanadium(IV), 98% TEMAV (791114-66-4) $C_{12}H_{32}N_4V$; FW: 283.35; dark green liq. <i>air sensitive, moisture sensitive</i>	250mg 1g 5g
23-2250 HAZ	Vanadium(III) acetylacetonate, 98% (13476-99-8) $V(CH_3COCHCOCH_3)_3$; FW: 348.27; brown xtl.; m.p. 178°; b.p. subl. (170°/0.05mm) <i>air sensitive, moisture sensitive</i>	25g 100g
23-2202	Vanadium(IV) bis(acetylacetonato)oxide, 98% (Vanadyl acetylacetonate) (3153-26-2) $VO(C_5H_7O_2)_2$; FW: 265.16; bluish green powdr.; m.p. 250° dec. For detailed technical note visit strem.com .	50g 250g
93-2335 HAZ	Vanadium(III) bromide (99.7%-V) (13470-26-3) $VBBr_3$; FW: 290.67; -20 mesh black powdr.; d. 4.00 <i>moisture sensitive</i>	1g 5g 25g
23-4300 HAZ	Vanadium(III) chloride, anhydrous, min. 95% (7718-98-1) VCl_3 ; FW: 157.30; purple powdr.; d. 3.00 <i>moisture sensitive</i>	10g 50g
23-4350 HAZ	Vanadium(III) chloride tetrahydrofuran adduct (19559-06-9) $VCl_3(C_4H_8O)_3$; FW: 373.61; red xtl. <i>moisture sensitive, (store cold)</i> For detailed technical note visit strem.com .	5g 25g
93-2320	Vanadium nitride (99%-V) (24646-85-3) VN; FW: 64.95; black powdr.; m.p. 2320°; d. 6.13	2g 10g
93-2312 HAZ	Vanadium(III) oxide, 95% (1314-34-7) V_2O_3 ; FW: 149.88; black powdr.; m.p. 1970°; d. 4.87	50g 250g
93-2309	Vanadium(IV) oxide, 99+% (12036-21-4) VO_2 ; FW: 82.94; black powdr.; m.p. 1967°; d. 4.339	2g 10g 50g
93-2306 HAZ	Vanadium(V) oxide, 98% (1314-62-1) V_2O_5 ; FW: 181.88; orange to brown powdr.; m.p. 690°; b.p. 1750° dec.; d. 3.357	100g 500g
93-2321 HAZ	Vanadium(V) oxide, 99.5% (1314-62-1) V_2O_5 ; FW: 181.88; -60 mesh orange to brown powdr.; m.p. 690°; b.p. 1750° dec.; d. 3.357	100g 500g
93-2337 HAZ	Vanadium(V) oxide (99.99%-V) PURATREM (1314-62-1) V_2O_5 ; FW: 181.88; -22 mesh orange powdr.; m.p. 690°; b.p. 1750° dec.; d. 3.357	5g 25g

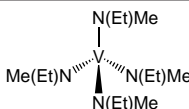
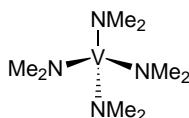

VANADIUM (Compounds)

93-2334 HAZ	Vanadium(IV) sulfate oxide hydrate (123334-20-3) VOSO ₄ ·XH ₂ O; FW: 163.00; blue lumps	25g 100g
93-2305 HAZ	Vanadium(V) trichloride oxide, min. 99% (7727-18-6) VOCl ₃ ; FW: 173.30; orange liq.; m.p. -77°; b.p. 126.7°; d. 1.829 <i>moisture sensitive</i>	100g 500g
93-2332 HAZ	Vanadium(V) trifluoride oxide, 98+% (13709-31-4) VOF ₃ ; FW: 123.94; yellow to orange powdr.; m.p. 300°; b.p. 480°; d. 2.459 <i>moisture sensitive</i>	5g 25g
23-5000 HAZ	Vanadium(V) tri-i-propoxy oxide, 98+% VTIP (5588-84-1) VO(OC ₃ H ₇) ₃ ; FW: 244.20; light yellow to light green liq.; b.p. 60-61°/0.5mm; f.p. 113°F; d. 1.035 <i>moisture sensitive</i>	5g 25g 100g
23-4380	Vanadyl(III) ethyl/butyl phosphonate Silica (PhosphonicS POVO) blue-green solid; SA: >350 m ² /g Note: Sold in collaboration with PhosphonicS Ltd. for research purposes only. PhosphonicS Metal Oxidation Catalyst Kit component.	5g 25g

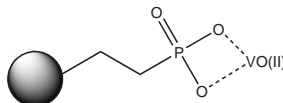

Technical Note:

- Catalyst used for oxidation of a wide variety allylic alcohols.

Particle size range: 70-200 microns

Average pore size: 60Å

Effective loadings: 0.3 to 0.5 mmol/g

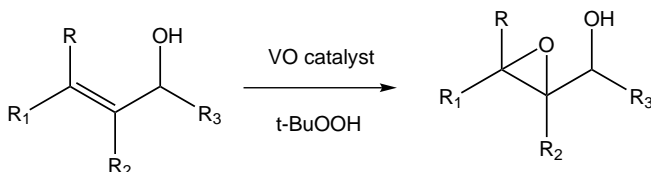

References:

- Tetrahedron Lett.*, **2004**, 45, 4465

23-6000	Vanadyl meso-tetraphenylporphine (14705-63-6) (C ₄₄ H ₂₈ N ₄)VO; FW: 679.67; purple xtl.	500mg 2g
23-4400	Vanadyl naphthenate, 35% in naphthenic acid (2.8-3.2% V) (68553-60-6) viscous liq.; f.p. > 350°F; d. 1.04	100g 500g 2.5kg
23-5841	Vanadyl octaethylporphine (27860-55-5) (C ₃₆ H ₄₄ N ₄)VO; FW: 599.71; red to purple xtl.	250mg 1g

XENON (Compounds)

54-1500 HAZ	Xenon(II) fluoride, 99.5% (13709-36-9) XeF ₂ ; FW: 169.30; white xtl.; m.p. 128-130°; d. 4.32 <i>moisture sensitive, (store cold)</i> Note: Packaged in PFA/FET bottle.	2g 10g
----------------	--	-----------

Technical Note:

- Xenon difluoride is a powerful fluorinating and oxidizing agent. Useful in the direct fluorination of alkenes and aromatics. Commercial uses include an etchant for silicon.

YTTERBIUM (Elemental Forms)

93-7031	Ytterbium chips (99.9% REO) (7440-64-4) Yb; FW: 173.04; chips; b.p. 1427° <i>air sensitive, moisture sensitive</i>	5g 25g
93-7035	Ytterbium foil (99.9% REO) (7440-64-4) Yb; FW: 173.04; 0.64 mm thick (~2.8g/25 x 25 mm); m.p. 824°; b.p. 1427°; d. 6.97 <i>air sensitive, moisture sensitive</i>	25 x 25mm 50 x 50mm

YTTERBIUM (Elemental Forms)

93-7033	Ytterbium foil (99.9% REO) (7440-64-4) Yb; FW: 173.04; 0.127 mm thick (~0.55g/25 x 25 mm); m.p. 824°; b.p. 1427°; d. 6.97 <i>air sensitive, moisture sensitive</i>	25 x 25mm 50 x 50mm
93-7032	Ytterbium ingot (99.9% REO) (7440-64-4) Yb; FW: 173.04; ingot; m.p. 824°; b.p. 1427°; d. 6.97 <i>air sensitive, moisture sensitive</i> For detailed technical note visit strem.com .	5g 25g
93-7030 HAZ	Ytterbium powder (99.9% REO) (7440-64-4) Yb; FW: 173.04; -20 to -40 mesh; m.p. 824°; b.p. 1427°; d. 6.97 <i>air sensitive, moisture sensitive</i>	2g 10g

YTTERBIUM (Compounds)

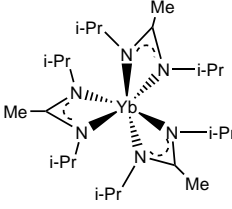
70-0075 amp HAZ	Tris(cyclopentadienyl)ytterbium (99.9%-Yb) (REO) (1295-20-1) (C ₅ H ₅) ₃ Yb; FW: 368.33; green xtl.; m.p. 273°; b.p. subl. 150° (vac.) <i>air sensitive, moisture sensitive</i>	1g 5g
70-1000	Tris(N,N'-di-i-propylacetamidinato)ytterbium(III), 99% Yb(C ₈ H ₁₇ N ₂) ₃ ; FW: 596.74; white to off-white pwdr. <i>air sensitive, moisture sensitive</i> Note: ALD precursor. Product sold under, use subject to, terms and conditions of label license at www.strem.com/harvard2 .	250mg 1g 5g
		
70-0200	Tris(6,6,7,7,8,8,8-heptafluoro-2,2-dimethyl-3,5-octanedionato)ytterbium(III), 99% (99.9%-Yb) (REO) [Yb(FOD)₃] (18323-96-1) Yb[C ₃ F ₇ COCHCOC(CH ₃) ₂] ₃ ; FW: 1058.59; off-white pwdr. <i>hygroscopic</i>	1g 5g
70-0100	Tris(2,2,6,6-tetramethyl-3,5-heptanedionato) ytterbium(III), 99% (99.9%-Yb) (REO) [Yb(TMHD)₃] (15492-52-1) Yb(C ₁₁ H ₁₉ O ₂) ₃ ; FW: 722.86; off-white xtl.; m.p. 167-169°; b.p. dec. 300° Note: Volatile precursor for the ALD, CVD and MOCVD deposition of ytterbium oxide.	1g 5g
93-7001	Ytterbium(III) acetate hydrate (99.9%-Yb) (REO) (15280-58-7) Yb(OOCCCH ₃) ₃ ·XH ₂ O; FW: 350.24; white pwdr.; d. 2.09	10g 50g
70-2202	Ytterbium(III) acetylacetonate hydrate (99.9%-Yb) (REO) (14284-98-1) Yb(CH ₃ COCHCOCH ₃) ₃ ·XH ₂ O; FW: 470.37; pwdr.	5g 25g
93-7025	Ytterbium(III) chloride, anhydrous (99.9%-Yb) (REO) (10361-91-8) YbCl ₃ ; FW: 279.40; white pwdr.; m.p. 854° <i>hygroscopic</i>	1g 5g 25g
93-7003	Ytterbium(III) chloride hexahydrate (99.9%-Yb) (REO) (10035-01-5) YbCl ₃ ·6H ₂ O; FW: 279.40 (387.49); white xtl.; d. 2.575	10g 50g
70-7003	Ytterbium(III) chloride hydrate (99.99+%-Yb) (REO) PURATREM (19423-87-1) YbCl ₃ ·XH ₂ O; FW: 279.40; white xtl.; d. 2.575	5g 25g
93-7004	Ytterbium(III) fluoride (99.9%-Yb) (REO) (13760-80-0) YbF ₃ ; FW: 230.04; white pwdr.; m.p. 1157°; b.p. 2200°; d. 8.168 <i>hygroscopic</i>	5g 25g
70-7004	Ytterbium(III) fluoride (99.99%-Yb) (REO) PURATREM (13760-80-0) YbF ₃ ; FW: 230.04; white pwdr.; m.p. 1157°; b.p. 2200°; d. 8.168 <i>hygroscopic</i>	5g 25g
70-2500	Ytterbium(III) hexafluoroacetylacetonate dihydrate (99.9%-Yb) (REO) (81849-60-7) Yb(CF ₃ COCHCOCF ₃) ₃ ·2H ₂ O; FW: 794.19 (830.22); white to off-white solid	1g 5g
93-7006 HAZ	Ytterbium(III) nitrate pentahydrate (99.9%-Yb) (REO) (35725-34-9) Yb(NO ₃) ₃ ·5H ₂ O; FW: 359.07 (449.15); white xtl.	5g 25g
93-7008	Ytterbium(III) oxide (99.9%-Yb) (REO) (1314-37-0) Yb ₂ O ₃ ; FW: 394.09; white pwdr.; m.p. 2227°; d. 9.17	25g 100g

YTTERBIUM (Compounds)

93-7010 HAZ	Ytterbium(III) perchlorate, 50% aqueous solution (99.9%-Yb) (REO) (13498-08-3) Yb(ClO ₄) ₃ ; FW: 471.39; colorless liq.	2g 10g
70-5000 amp HAZ	Ytterbium(III) i-propoxide (99.9%-Yb) (REO) (6742-69-4) Yb(OC ₃ H ₇) ₃ ; FW: 350.31; off-white powdr.; m.p. 200° dec.; b.p. subl. 190-200°/0.2mm <i>moisture sensitive</i>	1g 5g
93-7027	Ytterbium(III) sulfate octahydrate (99.9%-Yb) (REO) (10034-98-7) Yb ₂ (SO ₄) ₃ ·8H ₂ O; FW: 634.26 (778.39); white xtl.; d. 3.286	5g 25g
70-6000	Ytterbium(III) trifluoromethanesulfonate hydrate (Ytterbium triflate) (252976-51-5) Yb(SO ₃ CF ₃) ₃ ·XH ₂ O; FW: 620.25; white powdr. <i>hygroscopic</i>	1g 5g 25g

YTTRIUM (Elemental Forms)

93-3941	Yttrium chips (99.9% REO) (7440-65-5) Y; FW: 88.90; chips; m.p. 1522°; b.p. 3380°; d. 4.47 <i>air sensitive, moisture sensitive</i>	5g 25g
93-3945	Yttrium foil (99.9% REO) (7440-65-5) Y; FW: 88.90; 0.64 mm thick (~1.8g/25 x 25mm); m.p. 1522°; b.p. 3380°; d. 4.47 <i>air sensitive, moisture sensitive</i>	25 x 25mm 50 x 50mm
93-3944	Yttrium foil (99.9% REO) (7440-65-5) Y; FW: 88.90; 0.25 mm thick (~0.7g/25 x 25mm); m.p. 1522°; b.p. 3380°; d. 4.47 <i>air sensitive, moisture sensitive</i>	25 x 25mm 50 x 50mm
93-3943	Yttrium foil (99.9% REO) (7440-65-5) Y; FW: 88.90; 0.127 mm thick (~0.36g/25 x 25mm); m.p. 1522°; b.p. 3380°; d. 4.47 <i>air sensitive, moisture sensitive</i>	25 x 25mm 50 x 50mm
93-3942	Yttrium ingot (99.9% REO) (7440-65-5) Y; FW: 88.90; ingot; m.p. 1522°; b.p. 3380°; d. 4.47 <i>air sensitive, moisture sensitive</i> For detailed technical note visit strem.com .	10g 50g
93-3940 HAZ	Yttrium powder (99.9% REO) (7440-65-5) Y; FW: 88.90; -40 mesh; m.p. 1522°; b.p. 3380°; d. 4.47 <i>air sensitive, moisture sensitive</i>	5g 25g

YTTRIUM (Compounds)

03-2010	Lithium tris(S-(-)-1,1'-binaphthyl-2,2'-diolato)yttrate(III) tetrahydrofuran adduct, min. 97% (500995-67-5) See page 119	
39-1500 amp	Tris[N,N-bis(trimethylsilyl)amide]yttrium(III), min. 98% (99.9%-Y) (REO) (41836-28-6) {[(CH ₃) ₃ Si] ₂ N ₂ Y; FW: 570.06; white to off-white powdr.; m.p. 180-184°; b.p. subl. 105°/10 ⁻⁴ mm <i>air sensitive, moisture sensitive</i> Note: Available prepacked in ALD cylinder- see 98-4018. For detailed technical note visit strem.com .	1g 5g 25g
98-4018	Tris[N,N-bis(trimethylsilyl)amide]yttrium(III), min. 98% (99.9%-Y) (REO), 39-1500, contained in 50 ml Swagelok® cylinder (96-1070) for CVD/ALD (41836-28-6) {[(CH ₃) ₃ Si] ₂ N ₂ Y; FW: 570.06; white to off-white powdr.; m.p. 180-184°; b.p. subl. 105°/10 ⁻⁴ mm <i>air sensitive, moisture sensitive</i>	10g
39-4950 amp	Tris(butylcyclopentadienyl)yttrium (99.9%-Y) (REO) (312739-77-8) (C ₈ H ₈ C ₅ H ₇) ₃ Y; FW: 452.52; yellow liq. <i>air sensitive</i>	1g 5g
39-5000 amp HAZ	Tris(cyclopentadienyl)yttrium (99.9%-Y) (REO) (1294-07-1) (C ₅ H ₅) ₃ Y; FW: 284.20; off-white powdr.; m.p. 295°; b.p. subl. 200° (vac.) <i>air sensitive, moisture sensitive</i>	1g 5g
39-1550 NEW amp	Tris(N,N'-di-i-propylformamidinato)yttrium(III), 97% C ₂₁ H ₄₅ N ₆ Y; FW: 470.53; light beige-yellow solid <i>air sensitive, moisture sensitive</i> Note: Product sold under, use subject to, terms and conditions of label license at www.strem.com/harvard2	250mg 1g 5g

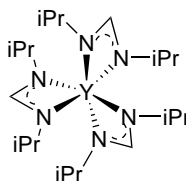

YTTRIUM (Compounds)

39-5100 amp HAZ	Tris(n-propylcyclopentadienyl)yttrium (99.9%-Y) (REO) (329735-73-1) (C ₃ H ₇ C ₅ H ₄) ₃ Y; FW: 410.44; yellow solid <i>air sensitive, moisture sensitive</i>	1g 5g
39-1000	Tris(2,2,6,6-tetramethyl-3,5-heptanedionato)yttrium(III), 98+% (99.9%-Y) (REO) [Y(TMHD)]₃ (15632-39-0) Y(C ₁₁ H ₁₉ O ₂) ₃ ; FW: 638.72; white to off-white xtl.; m.p. 170-173°; b.p. dec. 290° (subl. 95°/0.05mm)	1g 5g 25g
39-1015	Tris(2,2,6,6-tetramethyl-3,5-heptanedionato)yttrium(III) triglyme adduct (99.9%-Y) (REO) Y(C ₁₁ H ₁₉ O ₂) ₃ ·CH ₃ (OCH ₂ CH ₂) ₃ OCH ₃ ; FW: 638.72 (816.94); white xtl.; m.p. 77°; b.p. 100°/0.1mm	1g 5g
93-3930	Yttrium(III) acetate hydrate (99.9%-Y) (REO) (23363-14-6) Y(OOCCH ₃) ₃ ·XH ₂ O; FW: 266.06; white xtl.	25g 100g
93-3901	Yttrium(III) acetylacetonate hydrate (99.9%-Y) (REO) (207801-29-4) Y(CH ₃ COCHCOCH ₃) ₃ ·XH ₂ O; FW: 386.24; white to yellow xtl.	5g 25g 100g
93-3934	Yttrium(III) carbonate trihydrate (99.9%-Y) (REO) (5970-44-5) Y ₂ (CO ₃) ₃ ·3H ₂ O; FW: 357.83 (411.88); white powdr.	25g 100g
93-3935	Yttrium(III) chloride, anhydrous (99.9%-Y) (REO) (10361-92-9) YCl ₃ ; FW: 195.26; white powdr.; m.p. 721°; d. 2.67 <i>hygroscopic</i>	10g 50g
93-3903	Yttrium(III) chloride hexahydrate (99.9%-Y) (REO) (10025-94-2) YCl ₃ ·6H ₂ O; FW: 195.26 (303.26); white xtl.; d. 2.18	25g 100g
39-2400	Yttrium(III) 2-ethylhexanoate (15-17% Y), superconductor grade (99.9%-Y) (REO) (103470-68-4) Y[OOCCH(C ₂ H ₅)C ₄ H ₉] ₃ ; FW: 518.16; white powdr.	10g 50g
93-3936	Yttrium(III) fluoride (99.9%-Y) (REO) (13709-49-4) YF ₃ ; FW: 145.90; white powdr.; m.p. 1152°; d. 4.01 <i>hygroscopic</i>	10g 50g
39-2500	Yttrium(III) hexafluoroacetylacetonate, hydrate (99.9%-Y) (REO) (18911-76-7) Y(CF ₃ COCHCOCF ₃) ₃ ·XH ₂ O; FW: 710.10; white xtl.; m.p. 166-170°; b.p. dec. 240° (subl. 100°/0.2mm)	1g 5g 25g
93-3908	Yttrium(III) naphthenate, ~60% in toluene (7-13% Y) (99.9%-Y) (REO) (61790-20-3) viscous liq.	5g 25g
39-7000	Yttrium(III) neodecanoate, superconductor grade (12-16% Y) (99.9%-Y) (REO) (68683-17-0) Y(OOC ₁₀ H ₁₉) ₃ ; FW: 602.63; off-white powdr.	10g 50g 250g
93-3937 HAZ	Yttrium(III) nitrate hexahydrate (99.9%-Y) (REO) (13494-98-9) Y(NO ₃) ₃ ·6H ₂ O; FW: 274.92 (383.01); white xtl.	50g 250g
39-2940 HAZ	Yttrium(III) nitrate hexahydrate (99.999%-Y) (REO) PURATREM (13494-98-9) Y(NO ₃) ₃ ·6H ₂ O; FW: 274.92 (383.01); white xtl.	25g 100g
93-3931	Yttrium(III) oxalate hydrate (99.9%-Y) (REO) (13266-82-5) Y ₂ (C ₂ O ₄) ₃ ·XH ₂ O; FW: 441.87; white xtl.	25g 100g
93-3911	Yttrium(III) oxide (99.9%-Y) (REO) (1314-36-9) Y ₂ O ₃ ; FW: 225.81; white powdr.; m.p. 2410°; d. 5.01	25g 100g 500g
93-3910	Yttrium(III) oxide (99.99%-Y) (REO) PURATREM (1314-36-9) Y ₂ O ₃ ; FW: 225.81; white powdr.; m.p. 2410°; d. 5.01	50g 250g
93-3925	Yttrium(III) oxide (99.999%-Y) (REO) PURATREM (1314-36-9) Y ₂ O ₃ ; FW: 225.81; white powdr.; m.p. 2410°; d. 5.01	10g 50g 1kg
39-2990 NEW	Yttrium(III) oxide, 0.5-2.0 microns (99.95%-Y) (1314-36-9) Y ₂ O ₃ ; FW: 225.81; white powdr.; m.p. 2410°; d. 5.01	50g 250g
93-3913 HAZ	Yttrium(III) perchlorate, 50% aqueous solution (99.9%-Y) (REO) (14017-56-2) Y(ClO ₄) ₃ ; FW: 387.26; colorless liq.	10g 50g
39-2980	Yttrium(III) phosphate hydrate (99.99%-Y) (REO) PURATREM (34054-55-2) YPO ₄ ·XH ₂ O; FW: 183.88; white powdr.	5g 25g

YTTRIUM (Compounds)

93-3932 HAZ	Yttrium(III) i-propoxide (2172-12-5) Y[OCH(CH ₃) ₂] ₃ ; FW: 266.17; off-white pwdr. <i>moisture sensitive</i>	1g 5g 25g
39-3000 HAZ	Yttrium(III) i-propoxide (20-25% in toluene) (2172-12-5) Y[OCH(CH ₃) ₂] ₃ ; FW: 266.17; yellowish-brown liq.; f.p. 40°F (toluene) <i>moisture sensitive</i>	5g 25g 100g
93-3916	Yttrium(III) sulfate octahydrate (99.9%-Y) (REO) (7446-33-5) Y ₂ (SO ₄) ₃ ·8H ₂ O; FW: 465.99 (610.12); white xtl.; d. 2.558	25g 100g
39-4050	Yttrium(III) trifluoromethanesulfonate, min. 98% (Yttrium triflate) (52093-30-8) Y(CF ₃ SO ₃) ₃ ; FW: 536.12; white pwdr. <i>hygroscopic</i>	5g 25g

ZINC (Elemental Forms)

30-1500	Nano Zinc Metallic Powder (7440-66-6) See page 167	
93-3056 HAZ	Zinc dust (97.5%) (7440-66-6) Zn; FW: 65.38; -325 mesh; m.p. 419.58°; b.p. 907°; d. 7.14 <i>moisture sensitive</i>	250g 1kg 5kg
30-0045	Zinc foil (99.9%) (7440-66-6) Zn; FW: 65.38; 0.62mm thick x 15cm wide (~66g/10cm x 15cm); m.p. 419.58°; b.p. 907°; d. 7.14	10 x 15cm 50 x 15cm 250 x 15cm
30-0040	Zinc foil (99.9+%) (7440-66-6) Zn; FW: 65.38; 1.6mm thick, 15cm x 15cm (~225g/pc); m.p. 419.58°; b.p. 907°; d. 7.14	1pc 5pcs
30-0047	Zinc foil (99.98%) (7440-66-6) Zn; FW: 65.38; 0.25 mm thick x 30 cm wide (~265g/50cm x 30cm); m.p. 419.58°; b.p. 907°; d. 7.14	50 x 30cm 250 x 30cm
93-3060 HAZ	Zinc powder (99.9%) (7440-66-6) Zn; FW: 65.38; -325 mesh; m.p. 419.58°; b.p. 907°; d. 7.14 <i>moisture sensitive</i>	500g 4 x 500g
30-0050 HAZ	Zinc powder (99.999%) (7440-66-6) Zn; FW: 65.38; -40 mesh; m.p. 419.58°; b.p. 907°; d. 7.14 <i>moisture sensitive</i>	5g 25g
93-3055	Zinc rod (99.99+%) (7440-66-6) Zn; FW: 65.38; 1.27 cm dia. (~9g/cm); m.p. 419.58°; b.p. 907°; d. 7.14	100g 500g
30-0060	Zinc rod (99.9999%) (7440-66-6) Zn; FW: 65.38; 10 mm dia. (~5.6g/cm); m.p. 419.58°; b.p. 907°; d. 7.14	50mm 250mm
30-0080	Zinc shot (99.99%) (7440-66-6) Zn; FW: 65.38; 2-14 mesh; m.p. 419.58°; b.p. 907°; d. 7.14	250g 1kg
30-0070	Zinc shot (99.999%) (7440-66-6) Zn; FW: 65.38; 1-5 mm; m.p. 419.58°; b.p. 907°; d. 7.14	50g 250g 1kg
30-0090	Zinc wire (99.9999%) (7440-66-6) Zn; FW: 65.38; 1.0 mm dia. (~5.6g/m); m.p. 419.58°; b.p. 907°; d. 7.14	1m 5m

ZINC (Compounds)

30-0500	Bis(2,2,6,6-tetramethyl-3,5-heptanedionato)zinc, 99% [Zn(TMHD)]₂ (14363-14-5) Zn(C ₁₁ H ₁₉ O ₂) ₂ ; FW: 431.93; white xtl.; m.p. 144°; b.p. dec. 250°	1g 5g 25g
30-3020 HAZ	2,2,6,6-Bis(tetramethylpiperidine)zinc, magnesium chloride, lithium chloride complex 0.35M (12wt% ±2wt%) in toluene/tetrahydrofura (207788-38-3) C ₁₈ H ₃₆ Zn; FW: 317.87; amber to brown liq. <i>air sensitive, moisture sensitive</i> Note: A product of Rockwood Lithium. Sold for R&D purposes only.	.025mole

ZINC (Elemental Forms)

30-3055	Bis[4,4,4-trifluoro-1-(2-thienyl-1,3-butanedionato)zinc TMEDA adduct, 99% (873585-38-7) $C_{22}H_{24}F_9N_2O_4S_2Zn$; FW: 623.95; white pwdr. <i>hygroscopic</i> Note: Useful reagent for the MOCVD of zinc oxide.		1g 5g
93-3030	Diethylzinc, min. 95% (557-20-0) $Zn(C_2H_5)_2$; FW: 123.49; colorless liq.; m.p. -28°; b.p. 124°; f.p. -1°F; d. 1.18 <i>moisture sensitive, pyrophoric</i> Note: Available prepacked in ALD cylinder- see 98-4000, 98-4005.	100g	
98-4000	Diethylzinc, min. 95%, 93-3030, contained in 50 ml Swagelok® cylinder (96-1070) for CVD/ALD (557-20-0) $Zn(C_2H_5)_2$; FW: 123.49; colorless liq.; m.p. -28°; b.p. 124°; f.p. -1°F; d. 1.18 <i>moisture sensitive, pyrophoric</i> Note: High temperature Swagelok® cylinder assembly 96-1071 available at extra cost. See 98-4005.	25g	
98-4005	Diethylzinc, min. 95%, 93-3030, contained in high-temp 50 ml Swagelok® cylinder (96-1071) for CVD/ALD (557-20-0) $Zn(C_2H_5)_2$; FW: 123.49; colorless liq. <i>moisture sensitive, pyrophoric</i>	25g	
30-3029	Diethylzinc, min. 95% (10 wt% in hexanes) (Sure/Seal™ Bottle) (557-20-0) $Zn(C_2H_5)_2$; FW: 123.49; colorless liq. <i>air sensitive, moisture sensitive</i>	50g 250g	
97-4525	Diethylzinc, elec. gr. (99.9998%-Zn) PURATREM (557-20-0) $Zn(C_2H_5)_2$; FW: 123.49; colorless liq.; m.p. -28°; b.p. 124°; f.p. -1°F; d. 1.18 <i>moisture sensitive, pyrophoric</i>	100g	
97-5061	Dimethylzinc, 99% (544-97-8) $Zn(CH_3)_2$; FW: 95.44; colorless liq.; m.p. -42°; b.p. 46°; f.p. -1°F; d. 1.386 (20°) <i>moisture sensitive, pyrophoric</i> Note: Available prepacked in ALD cylinder- see 98-4001.	5g 25g 100g	
98-4001	Dimethylzinc, 99%, 97-5061, contained in 50 ml Swagelok® cylinder (96-1070) for CVD/ALD (544-97-8) $Zn(CH_3)_2$; FW: 95.44; colorless liq.; m.p. -42°; b.p. 46°; f.p. -1°F; d. 1.386 (20°) <i>moisture sensitive, pyrophoric</i>	25g	
30-5062	Dimethylzinc, min. 99% (10 wt% in hexanes) (Sure/Seal™ bottle) (544-97-8) $Zn(CH_3)_2$; FW: 95.44; colorless liq. <i>air sensitive, moisture sensitive</i>	50g 250g	
97-5060	Dimethylzinc, elec. gr. (99.999%-Zn) PURATREM (544-97-8) $Zn(CH_3)_2$; FW: 95.44; colorless liq.; m.p. -42°; b.p. 46°; f.p. -1°F; d. 1.386 (20°) <i>moisture sensitive, pyrophoric</i> Note: Available prepacked in ALD cylinder- see 98-4002.	50g 100g	
98-4002	Dimethylzinc, elec. gr. (99.999%-Zn) PURATREM, 97-5060, contained in 50 ml electropolished Swagelok® cylinder (96-1077) for CVD/ALD (544-97-8) $Zn(CH_3)_2$; FW: 95.44; colorless liq.; m.p. -42°; b.p. 46°; f.p. -1°F; d. 1.386 (20°) <i>moisture sensitive, pyrophoric</i>	10g	
30-0600 amp HAZ	Diphenylzinc, 99% (1078-58-6) $Zn(C_6H_5)_2$; FW: 219.58; white xtl.; m.p. 107°; b.p. 280-285°/760 mm <i>air sensitive, moisture sensitive</i>	1g 5g	

ZINC (Compounds)

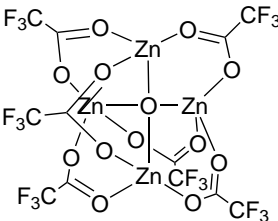
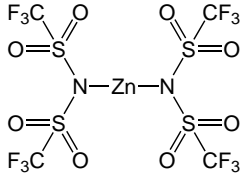
30-4050	Oxo[hexa(trifluoroacetato)]tetrazinc trifluoroacetic acid adduct ZnTAC₂₄TM (1299489-47-6) Zn ₄ (CF ₃ COO) ₆ (O)(CF ₃ COOH); FW: 955.65; white solid <i>moisture sensitive</i> Note: Manufactured under license of Takasago patent. For detailed technical note visit strem.com .		5g 25g
93-3001	Zinc acetate dihydrate, 98+% (ACS) (5970-45-6) Zn(OOCCH ₃) ₂ ·2H ₂ O; FW: 186.46 (219.50); white xtl.		250g 1kg
93-3031	Zinc acetylacetonate hydrate, 98% (108503-47-5) Zn(CH ₃ COCHCOCH ₃) ₂ ·XH ₂ O; FW: 263.59; white powdr.		50g 250g
30-3050	Zinc arsenide (99.5%-Zn) (12006-40-5) Zn ₃ As ₂ ; FW: 346.01; 1/8" gray pieces		5g 25g
30-1350	Zinc bis(trifluoromethylsulfonyl)imide, min. 97% (168106-25-0) Zn[(CF ₃ SO ₂) ₂ N] ₂ ; FW: 625.69; white powdr. <i>hygroscopic</i> For detailed technical note visit strem.com .		1g 5g
93-3032	Zinc bromide, 98+% (7699-45-8) HAZ ZnBr ₂ ; FW: 225.19; white powdr.; m.p. 394°; b.p. 650°; d. 4.201 <i>hygroscopic</i>		100g 500g
30-3032	Zinc bromide (99.9%-Zn) (7699-45-8) HAZ ZnBr ₂ ; FW: 225.19; white powdr.; m.p. 394°; b.p. 650°; d. 4.201 <i>hygroscopic</i>		50g 250g
30-3033	Zinc bromide (99.999%-Zn) PURATREM (7699-45-8) HAZ ZnBr ₂ ; FW: 225.19; white powdr.; m.p. 394°; b.p. 650°; d. 4.201 <i>hygroscopic</i>		5g 25g
93-3005	Zinc carbonate hydroxide (5263-02-5) 3Zn(OH) ₂ ·2ZnCO ₃ ; FW: 548.92; white powdr.; d. 4.398		100g 500g
93-3052	Zinc chloride (99.99%-Zn) PURATREM (7646-85-7) amp HAZ ZnCl ₂ ; FW: 136.28; -10 mesh spheres; m.p. 283°; b.p. 732°; d. 2.91		10g 50g
30-3012	Zinc chloride 2.2M (25wt% ±1wt%) in 2-methyltetrahydrofuran (7646-85-7) HAZ ZnCl ₂ ; FW: 136.28; liq. <i>air sensitive, moisture sensitive</i> Note: A product of Rockwood Lithium. Sold for R&D purposes only.		0.25mole 1mole
30-3006	Zinc chloride, anhydrous, min. 97% (ACS) (7646-85-7) HAZ ZnCl ₂ ; FW: 136.28; white powdr.; m.p. 283°; b.p. 732°; d. 2.91 <i>hygroscopic</i>		100g 500g
93-3033	Zinc cyclohexanebutyrate dihydrate (AAS) (38582-18-2) Zn[OOC(CH ₂) ₃ C ₆ H ₁₁] ₂ ·2H ₂ O; FW: 403.87 (439.90); white powdr.		5g
93-3038	Zinc 2-ethylhexanoate, ~80% in mineral spirits (14-15% Zn) (136-53-8) Zn[OOCCH(C ₂ H ₅)C ₄ H ₉] ₂ ; FW: 351.79; off-white, viscous liq.; f.p. 104°F; d. 1.07		100g 500g
30-3038	Zinc 2-ethylhexanoate, 99% (~18% Zn, 1% Diethylene glycol monomethyl ether) (136-53-8) Zn[OOCCH(C ₂ H ₅)C ₄ H ₉] ₂ ; FW: 351.79; slightly yellow viscous liq.; f.p. 260°F		100g 500g
93-3011	Zinc fluoride, anhydrous, 99% (7783-49-5) ZnF ₂ ; FW: 103.37; white xtl.; m.p. 872°; b.p. ~1500°; d. 4.95 <i>hygroscopic</i>		25g 100g
93-3012	Zinc fluoride tetrahydrate, 98% (13986-18-0) ZnF ₂ ·4H ₂ O; FW: 103.37 (175.43); white xtl.; d. 2.255		50g 250g
93-3035	Zinc hexafluoroacetylacetonate hydrate, min. 98% (16743-33-2) Zn(CF ₃ COCHCOCF ₃) ₂ ·XH ₂ O; FW: 479.47; white powdr.; m.p. 157-158°		1g 5g

ZINC (Compounds)

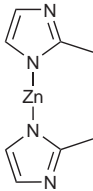
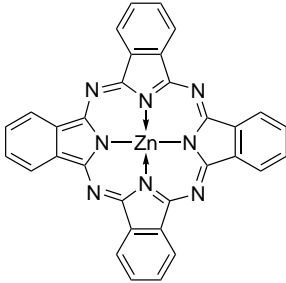
93-3014 HAZ	Zinc iodide, 98+% (10139-47-6) ZnI ₂ ; FW: 319.18; white to pale yellow powdr.; m.p. 445°; b.p. 624° dec.	50g 250g
30-3500	Zinc meso-tetraphenylporphine (14074-80-7) (C ₄₄ H ₂₈ N ₄)Zn; FW: 678.10; purple xtl.	250mg 1g 5g
30-4015 HAZ	Zinc 2-methylimidazole MOF (ZIF-8) (59061-53-9) C ₈ H ₁₀ N ₄ Zn; FW: 227.58; white solid For detailed technical note visit strem.com .	1g 5g
		
93-3036	Zinc molybdate, 98+% (13767-32-3) ZnMoO ₄ ; FW: 225.32; off-white powdr.	2g 10g
93-3037 HAZ	Zinc naphthenate, 65% in mineral spirits (10% Zn) (12001-85-3) viscous liq.; f.p. >100°F; d. 1.01	500g 2kg
93-3015 HAZ	Zinc nitrate hexahydrate, min. 98% (10196-18-6) Zn(NO ₃) ₂ ·6H ₂ O; FW: 189.41 (297.47); white xtl.; m.p. 36.4°; d. 2.065	100g 500g 2kg
93-3017	Zinc oxide, 99.7% (1314-13-2) ZnO; FW: 81.37; white powdr. (mean partical size 0.31 microns); m.p. 1975°; d. 5.606	500g 2kg
93-3016	Zinc oxide (99.999%-Zn) PURATREM (1314-13-2) ZnO; FW: 81.37; white powdr.; m.p. 1975°; d. 5.606	10g 50g
30-2700	Zinc oxide, catalyst (85-95% ZnO, 3-7% Al₂O₃, 0.5-3% CaO) (1314-13-2) ZnO; FW: 81.37; 3/16" extrusions; SA: ~35 m ² /g	100g 500g
30-1405	Zinc oxide nanopowder (1314-13-2) See page 167	
93-3039	Zinc oxide, sintered tablets (99.9%-Zn) (1314-13-2) ZnO; FW: 81.37; ~10-12mm dia. x 4-5mm thick (~2.3g ea.); m.p. 1975°; d. 5.606	25g 100g
93-3018 HAZ	Zinc perchlorate hexahydrate, 99% (10025-64-6) Zn(ClO ₄) ₂ ·6H ₂ O; FW: 264.27 (372.36); white xtl.; m.p. 106°; b.p. 200° dec.; d. 2.252	100g 500g
93-3020	Zinc phosphate hydrate (7543-51-3) Zn ₃ (PO ₄) ₂ ·XH ₂ O; FW: 386.05; white powdr.; d. 3.04	500g 2kg
30-3000	Zinc phthalocyanine, min. 95% (14320-04-8) (C ₃₂ H ₁₆ N ₈)Zn; FW: 577.91; purple powdr.	2g 10g
		
30-3095	Zinc i-propoxide, 99% (13282-39-8) Zn(OC ₃ H ₇) ₂ ; FW: 183.56; white powdr. <i>moisture sensitive</i>	1g 5g
30-3090	Zinc protoporphyrin (15442-64-5) (C ₃₄ H ₃₂ N ₄ O ₄)Zn; FW: 626.03; purple xtl.	10mg 50mg
93-3041	Zinc selenide (99.99%-Zn) PURATREM (1315-09-9) ZnSe; FW: 144.33; yellow, granular solid; m.p. > 1100°; d. 5.42	5g 25g 100g
93-3023	Zinc selenide (99.999%-Zn) PURATREM (1315-09-9) ZnSe; FW: 144.33; yellow powdr.; m.p. > 1100°; d. 5.42	10g 50g

ZINC (Compounds)

93-3045	Zinc sulfate monohydrate, 99% (7446-19-7) ZnSO ₄ ·H ₂ O; FW: 161.43 (179.45); white powdr.	250g 1kg
93-3025	Zinc sulfide (99.9%-Zn) (1314-98-3) ZnS; FW: 97.43; white powdr.; m.p. 1700°; d. 4.10	25g 100g
30-3024	Zinc sulfide (99.99%-Zn) (fused granules) PURATREM (1314-98-3) ZnS; FW: 97.43; 2.5-5.0mm granules; m.p. 1700°; d. 4.10	5g 25g 100g
93-3046	Zinc telluride (99.99%-Zn) PURATREM (1315-11-3) ZnTe; FW: 192.97; gray powdr.; m.p. 1240°; d. 6.34	10g 50g
93-3010	Zinc tetrafluoroborate hydrate, 98% (13826-88-5) Zn(BF ₄) ₂ ·XH ₂ O; FW: 238.98; white xtl.	25g 100g
30-4000 HAZ	Zinc trifluoromethanesulfonate, min. 98% (Zinc triflate) (54010-75-2) Zn(SO ₃ CF ₃) ₂ ; FW: 363.54; white powdr. <i>hygroscopic</i> For detailed technical note visit strem.com .	5g 25g

ZIRCONIUM (Elemental Forms)

40-0055	Zirconium crystal bar turnings (99.5%) (7440-67-7) Zr; FW: 91.22; 1.0mm thick x 7mm wide; m.p. 1852°; b.p. 3577°; d. 6.506	10g 50g
93-4046 HAZ	Zirconium foil (99.5%) (7440-67-7) Zr; FW: 91.22; 0.025 mm thick x 300 mm wide; m.p. 1852°; b.p. 3577°; d. 6.506	100 x 300mm 400 x 300mm
40-0070	Zirconium foil (99.8%) (7440-67-7) Zr; FW: 91.22; 1.0mm thick (~16.3g/50 x 50mm); m.p. 1852°; b.p. 3577°; d. 6.506	50 x 50mm 100 x 100mm 100 x 425mm
40-0075	Zirconium foil (99.8%) (7440-67-7) Zr; FW: 91.22; 0.25mm thick x 125mm wide (20.6g/100 x 125mm); m.p. 1852°; b.p. 3577°; d. 6.506	100 x 125mm 500 x 125mm 2000 x 125mm
93-4047 HAZ	Zirconium powder (99.5%) (7440-67-7) Zr; FW: 91.22; -50 mesh powdr.; m.p. 1852°; b.p. 3577°; d. 6.506 <i>air sensitive</i>	100g 500g
93-4049	Zirconium rod (99.2+%) (7440-67-7) Zr; FW: 91.22; 12.7 mm dia. (~8.2g/cm); m.p. 1852°; b.p. 3577°; d. 6.506	5cm 30cm
40-0080	Zirconium rod (99.8%) (7440-67-7) Zr; FW: 91.22; 6.2 mm dia. (2g/cm); m.p. 1852°; b.p. 3577°; d. 6.506	5cm 30cm

ZIRCONIUM (Compounds)

40-0900 amp	Bis(n-butylcyclopentadienyl)zirconium dichloride, min. 98% (73364-10-0) [(C ₄ H ₉)C ₅ H ₄] ₂ ZrCl ₂ ; FW: 404.53; off-white powdr. <i>moisture sensitive</i>	1g 5g
40-0750	Bis(t-butylcyclopentadienyl)zirconium dichloride, min. 98% (32876-92-9) [(C ₄ H ₉)C ₅ H ₄] ₂ ZrCl ₂ ; FW: 404.53 <i>moisture sensitive</i>	1g 5g
40-1000	Bis(cyclopentadienyl)dimethylzirconium, min. 97% (12636-72-5) (C ₅ H ₅) ₂ Zr(CH ₃) ₂ ; FW: 251.48; white xtl. <i>air sensitive, (store cold)</i>	1g 5g
40-1040	Bis(cyclopentadienyl)zirconium chloride hydride (Schwartz's Reagent), 95% (37342-97-5) (C ₅ H ₅) ₂ ZrClH; FW: 257.87; off-white powdr.; m.p. > 300° <i>light sensitive, moisture sensitive</i> For detailed technical note visit strem.com .	1g 5g 25g

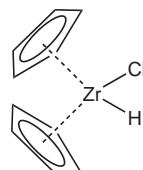

ZIRCONIUM (Compounds)

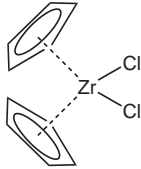
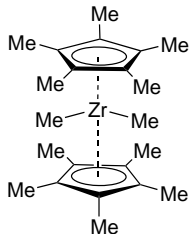
93-4002	Bis(cyclopentadienyl)zirconium dichloride, 99% (Zirconocene dichloride) (1291-32-3) (C ₅ H ₅) ₂ ZrCl ₂ ; FW: 292.32; white to off-white powdr. <i>moisture sensitive</i> For detailed technical note visit strem.com.		5g 25g 100g
40-1030 amp	Bis(ethylcyclopentadienyl)zirconium dichloride, min. 97% (73364-08-6) [(C ₂ H ₅)C ₅ H ₄] ₂ ZrCl ₂ ; FW: 348.43; pale yellow powdr. <i>moisture sensitive</i>		1g 5g 25g
40-1041 amp HAZ	Bis(indenyl)zirconium dichloride, min. 98% (12148-49-1) (C ₉ H ₇) ₂ ZrCl ₂ ; FW: 392.44; yellow powdr. <i>moisture sensitive</i>		1g 5g 25g
40-1042 amp HAZ	Bis(2-methylindenyl)zirconium dichloride, 98% (165688-64-2) [(CH ₃)C ₉ H ₆] ₂ ZrCl ₂ ; FW: 420.49; yellow powdr. <i>moisture sensitive</i>		1g 5g
40-1054 NEW	Bis(pentamethylcyclopentadienyl)dimethylzirconium(IV), 99% (67108-80-9) [(CH ₃) ₅ C ₅] ₂ Zr(CH ₃) ₂ ; FW: 391.75; white to off-white xtl. <i>air sensitive, moisture sensitive</i> For detailed technical note visit strem.com.		250mg 1g 5g
40-1044	Bis(pentamethylcyclopentadienyl)zirconium dichloride, 99% (54039-38-2) [(CH ₃) ₅ C ₅] ₂ ZrCl ₂ ; FW: 432.56; pale yellow xtl. <i>moisture sensitive</i>		1g 5g
40-1050 amp	Bis(i-propylcyclopentadienyl)zirconium dichloride, 98% (58628-40-3) [(C ₃ H ₇)C ₅ H ₄] ₂ ZrCl ₂ ; FW: 376.48; off-white powdr. <i>moisture sensitive</i>		1g 5g
40-1056	(+)-Bis[1-((1'R,2'R,5'R)-2'-i-propyl-5'-methylcyclohexyl)indenyl]zirconium(IV) dichloride (148347-90-4) (C ₁₉ H ₂₆) ₂ ZrCl ₂ ; FW: 668.93; orange powdr. <i>moisture sensitive</i> For detailed technical note visit strem.com.		100mg 500mg
40-1060 amp	Bis(tetramethylcyclopentadienyl)zirconium dichloride, min. 97% (119445-90-8) [(CH ₃) ₄ C ₅ H ₄] ₂ ZrCl ₂ ; FW: 404.53; off-white powdr. <i>moisture sensitive</i>		1g 5g 25g
40-1080	n-Butylcyclopentadienylzirconium trichloride (329735-75-3) [(C ₄ H ₉)C ₅ H ₄] ₂ ZrCl ₃ ; FW: 318.78; dark orange solid <i>moisture sensitive, (store cold)</i>		1g 5g
40-1100 amp	Cyclopentadienylzirconium trichloride, min. 98% (34767-44-7) (C ₅ H ₅)ZrCl ₃ ; FW: 262.67; off-white to tan powdr.; m.p. 237° dec. <i>moisture sensitive</i>		1g 5g
40-1110	Dimethylbis(t-butylcyclopentadienyl)zirconium, min. 98% (68193-40-8) [(C ₄ H ₉)C ₅ H ₄] ₂ Zr(CH ₃) ₂ ; FW: 363.70; pale yellow powdr. <i>air sensitive, moisture sensitive</i>		250mg 1g 5g
40-1115	[Dimethylbis(cyclopentadienyl)silyl]zirconium dichloride, min. 98% (86050-32-0) [(CH ₃) ₂ Si(C ₅ H ₅) ₂] ₂ ZrCl ₂ ; FW: 348.46; yellow xtl. <i>moisture sensitive</i> Note: Product sold under, use subject to, terms and conditions of label license at www.strem.com/harvard1 .		1g 5g
40-1120	Dimethylbis(indenyl)zirconium, min. 98% (49596-04-5) (C ₉ H ₇) ₂ Zr(CH ₃) ₂ ; FW: 351.60; off-white powdr. <i>air sensitive, moisture sensitive</i>		1g 5g

ZIRCONIUM (Compounds)

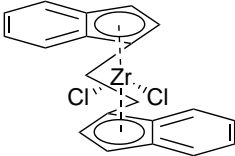
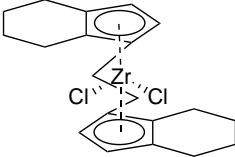
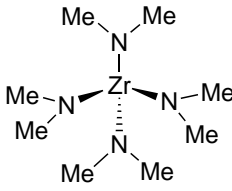
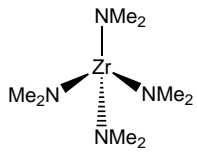
40-1142	rac-Dimethylsilylbis(1-indenyl)zirconium dichloride, min. 97% (121009-93-6) (CH ₃) ₂ Si(C ₉ H ₆) ₂ ZrCl ₂ ; FW: 448.53; orange powdr. <i>moisture sensitive</i> For detailed technical note visit strem.com .	100mg 500mg	
40-1150	rac-Ethylenebis(indenyl)zirconium(IV) dichloride (100080-82-8) C ₂₀ H ₁₆ ZrCl ₂ ; FW: 418.48; yellow to orange powdr. <i>moisture sensitive</i>		1g 5g
40-1400	rac-Ethylenebis(4,5,6,7-tetrahydro-1-indenyl) zirconium dichloride (100163-29-9) C ₂₄ H ₄ (C ₉ H ₁₀) ₂ ZrCl ₂ ; FW: 426.54; white to pale yellow powdr. <i>moisture sensitive</i> For detailed technical note visit strem.com .		100mg 500mg
40-1500 amp	Pentamethylcyclopentadienylzirconium trichloride, 99% (75181-07-6) (CH ₃) ₅ C ₅ ZrCl ₃ ; FW: 332.81; pale yellow xtl. <i>moisture sensitive</i>	1g 5g	
40-1650 amp HAZ	Tetrabenzylzirconium, min. 95% (24356-01-2) (C ₆ H ₅ CH ₂) ₄ Zr; FW: 455.75; yellow to orange solid <i>air sensitive, heat sensitive, moisture sensitive, (store cold)</i>	250mg 1g 5g	
40-1700 HAZ	Tetrachlorobis(tetrahydrofuran)zirconium (21959-01-3) ZrCl ₄ ·2C ₄ H ₈ O; FW: 377.25; white xtl. <i>moisture sensitive</i>	10g 50g	
93-4040 amp HAZ	Tetrakis(diethylamino)zirconium, 99% (13801-49-5) Zr[(N(CH ₂ CH ₃) ₂) ₄]; FW: 379.74; yellow liq.; b.p. 112°/0.1mm; d. 1.026 <i>moisture sensitive, (store cold)</i>	5g 25g	
40-4100 HAZ	Tetrakis(dimethylamino)zirconium, 99% TDMAZ (19756-04-8) Zr[(N(CH ₃) ₂) ₄]; FW: 267.53; light yellow xtl.; m.p. 57-60°; b.p. 80°/0.1mm <i>moisture sensitive, (store cold)</i> Note: Product sold under, use subject to, terms and conditions of label license at www.strem.com/harvard1 . Available prepacked in ALD cylinder- see 98-4012 page 456.		1g 5g 25g
98-4012 HAZ	Tetrakis(dimethylamino)zirconium, 99% TDMAZ, 40-4100, contained in 50 ml Swagelok® cylinder (96-1070) for CVD/ALD (19756-04-8) Zr[(N(CH ₃) ₂) ₄]; FW: 267.53; light yellow xtl.; m.p. 57-60°; b.p. 80°/0.1mm <i>moisture sensitive, (store cold)</i> Note: Product sold under, use subject to, terms and conditions of label license at www.strem.com/harvard1 .	25g	
40-4115 NEW amp HAZ	Tetrakis(dimethylamino)zirconium(IV), 99% (99.99%-Zr) PURATREM TDMAZ (19756-04-8) Zr[(N(CH ₃) ₂) ₄]; FW: 267.53; light-yellow xtl.; m.p. 57-60°; b.p. 80° (0.1mm) <i>moisture sensitive, (store cold)</i> Note: Product sold under, use subject to, terms and conditions of label license at www.strem.com/harvard1 .		1g 5g 25g
98-4042 NEW HAZ	Tetrakis(dimethylamino)zirconium(IV), 99% (99.99%-Zr) TDMAZ, 40-4115, contained in 50ml Swagelok® cylinder (96-1070) for CVD/ALD (19756-04-8) Zr[(N(CH ₃) ₂) ₄]; FW: 267.53; light yellow xtl. <i>moisture sensitive, (store cold)</i> Note: Product sold under, use subject to, terms and conditions of label license at www.strem.com/harvard1	25g	

ZIRCONIUM (Compounds)

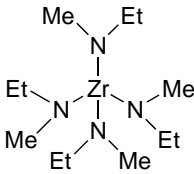
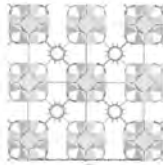
40-1710 amp HAZ	Tetrakis(ethylmethylamino)zirconium(IV), 99% TEMAZ (175923-04-3) Zr[N(CH ₃)(CH ₂ CH ₃) ₂] ₄ ; FW: 323.63; light yellow liq.; d. 1.0499 <i>moisture sensitive</i> Note: Product sold under, use subject to, terms and conditions of label license at www.strem.com/harvard1 . Available prepacked in ALD cylinder- see 98-4039.		1g 5g 25g
98-4039 HAZ	Tetrakis(ethylmethylamino)zirconium(IV) 99% TEMAZ, 40-1710, contained in 50 ml Swagelok® cylinder (96-1070) for CVD/ALD (175923-04-3) Zr[N(CH ₃)(CH ₂ CH ₃) ₂] ₄ ; FW: 323.63; light yellow liq. <i>moisture sensitive</i> Note: High temperature Swagelok® cylinder assembly 96-1071 available at extra cost. Product sold under, use subject to, terms and conditions of label license at www.strem.com/harvard1		10g 25g
40-5000	Tetrakis(2,2,6,6-tetramethyl-3,5-heptanedionato) zirconium(IV), 99% [Zr(TMHD)] ₄ (18865-74-2) Zr(C ₁₁ H ₁₉ O ₂) ₄ ; FW: 824.30; white xtl.; m.p. 318-320°; b.p. subl. 180°/0.1mm		1g 5g 25g
93-4005	Zirconium(IV) acetylacetonate, min. 98% (17501-44-9) Zr(CH ₃ COCHCOCH ₃) ₄ ; FW: 487.66; white powdr.; m.p. 190°		25g 100g
93-4021 HAZ	Zirconium(IV) bromide, 98% (99+%-Zr) (13777-25-8) ZrBr ₄ ; FW: 410.86; off-white powdr.; m.p. 450° (15 atm); d. 4.201 <i>moisture sensitive</i>		5g 25g
40-1749 amp	Zirconium(IV) t-butoxide, 99% (2081-12-1) Zr(OC ₄ H ₉) ₄ ; FW: 383.68; slightly yellow liq.; b.p. 90°/5mm; f.p. 185°F; d. 0.96 <i>moisture sensitive, (store cold)</i>		5g 25g 4 x 25g
40-1750 amp	Zirconium(IV) t-butoxide (99.99%-Zr) PURATREM (2081-12-1) Zr(OC ₄ H ₉) ₄ ; FW: 383.68; slightly yellow liq.; b.p. 90°/5mm; f.p. 185°F; d. 0.96 <i>moisture sensitive, (store cold)</i>		2g 10g 2 x 25g
93-4003 HAZ	Zirconium(IV) n-butoxide (76-80% in n-butanol) (1071-76-7) Zr(OC ₄ H ₉) ₄ ; FW: 383.68; orange liq.; f.p. 101°F; d. 1.063 <i>moisture sensitive</i>		50g 250g 1kg
93-4006 HAZ	Zirconium carbide (99+%-Zr) (12070-14-3) ZrC; FW: 103.23; 3 micron black powdr.; m.p. 3540°; b.p. 5100°; d. 6.73		25g 100g
93-4007	Zirconium(IV) carbonate, basic hydrate (12671-00-0) [Zr ₃ (CO ₃) ₃ O ₅ ·H ₂ O]; FW: 431.68; white powdr.		500g 2kg
93-4045 HAZ	Zirconium(IV) chloride (99.5+%-Zr) (10026-11-6) ZrCl ₄ ; FW: 233.03; white powdr.; m.p. 437° (25 atm); b.p. 331° subl.; d. 2.803 <i>moisture sensitive</i>		50g 250g
40-4046 HAZ	Zirconium(IV) chloride, sublimed grade (99.95+%-Zr) (10026-11-6) ZrCl ₄ ; FW: 233.03; white powdr.; m.p. 437° (25 atm); b.p. 331° subl.; d. 2.803 <i>moisture sensitive</i>		50g 250g 1kg
40-1105	Zirconium 1,4-dicarboxybenzene MOF (UiO-66) (1072413-89-8) C ₄₈ H ₂₈ O ₃₂ Zr ₆ ; FW: 1664.06; white powdr.; SA: > 1100m ² Note: Sold under license from Inven2 AS for research purposes only. EP 09738396 and US 12/989,641. For detailed technical note visit strem.com .		500mg 2g
93-4036 HAZ	Zirconium(IV) dichloride oxide hydrate (99.9%-Zr) (15461-27-5) ZrOCl ₂ ·XH ₂ O; FW: 178.13; white powdr.; d. 1.910		25g 100g
40-2500 HAZ	Zirconium(IV) dichloride oxide hydrate (99.99+%-Zr) PURATREM (15461-27-5) ZrOCl ₂ ·XH ₂ O; FW: 178.13; white xtl.		25g 100g
93-4042 HAZ	Zirconium(IV) dinitrate oxide hydrate (14985-18-3) ZrO(NO ₃) ₂ ·XH ₂ O; FW: 231.23; white powdr.		50g 250g
93-4043 HAZ	Zirconium(IV) ethoxide, 99+% (18267-08-8) Zr(OC ₂ H ₅) ₄ ; FW: 271.47; white powdr.; m.p. 171-173° <i>moisture sensitive</i>		5g 25g

ZIRCONIUM (Compounds)

93-4023	Zirconium(IV) fluoride, 98% (7783-64-4) ZrF ₄ ; FW: 167.21; white powdr.; m.p. ~600° subl.; d. 4.43 <i>moisture sensitive</i>	25g 100g
93-4024	Zirconium(IV) fluoride (99.9%-Zr) (7783-64-4) ZrF ₄ ; FW: 167.21; -4 mesh white powdr.; m.p. ~600° subl.; d. 4.43 <i>moisture sensitive</i>	10g 50g
40-3000	Zirconium(IV) hexafluoroacetylacetonate (19530-02-0) Zr(CF ₃ COCHCOCF ₃) ₄ ; FW: 919.47; white to off-white xtl.; m.p. 41-43°; b.p. 225° <i>hygroscopic</i>	5g 25g
93-4025	Zirconium(IV) iodide (99.5%-Zr) (13986-26-0) ZrI ₄ ; FW: 598.84; reddish-brown powdr.; m.p. 499° (6.3 atm) <i>moisture sensitive</i>	1g 5g
93-4034	Zirconium nitride, 98% (25658-42-8) ZrN; FW: 105.23; brown powdr.; m.p. 2980°; d. 7.09	10g 50g
93-4013	Zirconium(IV) oxide, 99+% (1314-23-4) ZrO ₂ ; FW: 123.22; white powdr.; m.p. 2715°; d. 5.6	250g 1kg
40-4000	Zirconium(IV) oxide-yttria stabilized, 99% (64417-98-7) ZrO ₂ /10-15% Y ₂ O ₃ ; -325 mesh (44 microns or less) powdr.	100g 500g
40-4002	Zirconium(IV) oxide-yttria stabilized, 99% (64417-98-7) ZrO ₂ /10-15% Y ₂ O ₃ ; -150 + 325 mesh powdr.	100g 500g
40-4003	Zirconium(IV) oxide-yttria stabilized (99.95%-Zr) (64417-98-7) ZrO ₂ /5.2% Y ₂ O ₃ ; < 3 micron powdr. (precipitated)	100g 500g
93-4017 HAZ	Zirconium(IV) n-propoxide (23-28% free alcohol) (23519-77-9) Zr(OC ₃ H ₇) ₄ ; FW: 327.56; yellow liq.; f.p. 83°F; d. 1.05 <i>moisture sensitive</i>	250g 1kg
40-4016 HAZ	Zirconium(IV) i-propoxide (isopropanol adduct) (99.9%-Zr) (14717-56-7) Zr(OC ₃ H ₇) ₄ ·C ₃ H ₇ OH; FW: 327.56 (387.67); white xtl.; b.p. dec. <i>moisture sensitive</i>	10g 50g
93-4019	Zirconium silicate, 98% (10101-52-7) ZrSiO ₄ ; FW: 183.30; white to off-white powdr.; m.p. 2550°; d. 4.56	250g 1kg
93-4020	Zirconium(IV) sulfate oxide hydrate (62010-10-0) ZrO(OH) _{0.8} (SO ₄) _{0.6} ·XH ₂ ; FW: ~178.0; white powdr.	500g 2kg
40-4750	Zirconium(IV) sulfate tetrahydrate (99.99+%-Zr) PURATREM (7446-31-3) Zr(SO ₄) ₂ ·4H ₂ O; FW: 283.33 (355.39); white xtl.; m.p. 100° (-3H ₂ O)	25g 100g
93-4033	Zirconium(IV) sulfide, 99% (12039-15-5) ZrS ₂ ; FW: 155.35; -200 mesh reddish-brown powdr.; m.p. 1550°; d. 3.87	2g 10g
93-4026	Zirconium(IV) trifluoroacetylacetonate, 99% (17499-68-2) Zr(CF ₃ COCHCOCF ₃) ₄ ; FW: 703.54; white powdr.; m.p. 125-128°; b.p. dec. 235° (subl. 130°/0.05mm)	1g 5g 25g
40-2750 HAZ	Zirconyl 2-ethylhexanoate in mineral spirits (~6% Zr) (22464-99-9) liq.; f.p. 104°F	100g 500g

Index of Kits

Biocatalyst Kits		Page #
96-4050	CalB immo KIT™ - Immobilized enzyme.....	462
96-4065	Lipase immo Kit - Immobilized enzymes.....	462
96-0224	Novozymes Endoprotease Screening Kit (contains 6 endoprotease enzymes).....	463
96-0220	Novozymes Lipase Screening Kit (contains 9 lipase enzymes).....	463
96-1580	Provivi Carbene/Nitrene Transferase Screening Kit.....	464

Catalyst & Organocatalyst Kits		Page #
96-0400	Apeiron Ruthenium Metathesis Catalyst Kit.....	466
96-6715	BASF Blocking Group Removal Catalyst Kit.....	467
96-6717	BASF Heterogeneous Catalyst Kit.....	467
96-6719	BASF Palladium Catalyst Kit.....	468
96-6721	BASF Platinum Catalyst Kit.....	468
96-3735	[1,1'-Bis(dialkyl/diarylphosphino)ferrocene]palladium(II) dichloro Catalyst Kit.....	468
96-5503	Buchwald Palladacycle Precatalyst Kit 1 (Chloro-2-aminoethylphenyl- Palladacycles Gen. 1).....	469
96-5508	Buchwald Palladacycle Precatalyst Kit 3 (Chloro- 2'-amino-1,1'-biphenyl-2-yl - Palladacycles Gen. 2).....	470
96-5505	Buchwald Palladacycle Precatalyst Kit 2a (Methanesulfonato-2'-amino-1,1'-biphenyl-2-yl- Palladacycles Gen. 3).....	471
96-5506	Buchwald Palladacycle Precatalyst Kit 2b (Methanesulfonato-2'-amino-1,1'-biphenyl-2-yl- Palladacycles Gen. 3).....	473
96-5512	Buchwald Palladacycle Precatalyst Kit 4 (Methanesulfonato-2'-methylamino-1,1'-biphenyl-2-yl- Palladacycles Gen. 4).....	475
96-7650	CATHy Catalyst Kit for Asymmetric Transfer Hydrogenation of Ketones and Imines.....	476
96-5900	Chiral Quest Catalyst and Ligand Toolbox Kit for Asymmetric Hydrogenation.....	478
96-1575	Cinchona Alkaloid-Derived Organocatalyst Kit - (enantiopure primary amines) for Iminium-Enamime Activation.....	478
96-4730	(R,R)-Duphos and BPE Rhodium Catalyst Kit for Asymmetric Hydrogenation.....	479
96-4731	(S,S)-Duphos and BPE Rhodium Catalyst Kit for Asymmetric Hydrogenation.....	480
96-3705	Enantiotech BIMAH Ru BINAP Catalyst Kit for Asymmetric Hydrogenation.....	481
96-3715	Enantiotech BIMAH Ru DIOP Catalyst Kit for Asymmetric Hydrogenation.....	482
96-3710	Enantiotech BIMAH Ru Tol-BINAP Catalyst Kit for Asymmetric Hydrogenation.....	483
96-6670	Evonik Heterogeneous Catalyst Kit.....	484
96-6674	Evonik Heterogeneous Catalyst Kit for Selective Hydrogenation.....	484
96-6672	Evonik Heterogeneous Palladium Catalyst Kit.....	484
96-3745	Iridicycle Catalyst Kit.....	486
96-3790	Kit of CatKits - Single-Use Vials for Low Catalyst Loading Experiments.....	486
96-3750	Maruoka Chiral Phase-Transfer Phosphonium Organocatalyst Kit.....	487
96-4650	Palladium Kit.....	488
96-6770	PhosphonicS Metal Oxidation Catalyst Kit.....	488
96-7710	SpinPHOX-Ir Catalyst Kit for enantioselective hydrogenation.....	489
96-6955	Takasago ATH (Asymmetric Transfer Hydrogenation) Catalyst Kit.....	490
96-6953	Takasago BINAP Ru Acetate Catalyst Kit.....	492
96-6951	Takasago BINAP Ru Cymene Catalyst Kit.....	493
96-6954	Takasago BINAP Ru Diamine Catalyst Kit.....	494
96-6952	Takasago BINAP Ru Dimer Catalyst Kit.....	495
96-6901	Takasago SEGPPOS® Ru Catalyst Kit.....	496

Ionic Liquid Kits		Page #
96-6500	Ionic Liquid Kit 1: Hydrophobic (water-immiscible) Kit.....	498
96-6510	Ionic Liquid Kit 2:BMIM Kit.....	499
96-6520	Ionic Liquid Kit 3: CYPHOS® IL Phosphonium Salt Kit.....	499

Ligand Kits		Page #
96-3810	AntPhos and WingPhos Kit.....	500
96-3730	1,1'-Bis(dialkyl/diarylphosphino)ferrocene Ligand Kit.....	501
96-5500	Buchwald Biaryl Phosphine Ligand Master Kit for Aromatic Carbon-Heteroatom Bond Formation, Suzuki Coupling and Negishi Cross-coupling.....	501

Index of Kits

Ligand Kits		Page #
96-5485	Buchwald Biaryl Phosphine Ligand Mini Kit 1 for Aromatic Carbon-Heteroatom Bond Formation, Suzuki Coupling and Negishi Cross-coupling.....	504
96-5490	Buchwald Biaryl Phosphine Ligand Mini Kit 2 for Aromatic Carbon-Heteroatom Bond Formation, Suzuki Coupling and Negishi Cross-coupling	505
96-5495	Buchwald Biaryl Phosphine Ligand Mini Kit 3 for Aromatic Carbon-Heteroatom Bond Formation, Suzuki Coupling and Negishi Cross-coupling	505
96-0445	Chiral SpiroPAP Ligand Kit.....	507
96-0070	Chiral SpiroSAP Ligand Kit.....	508
96-5650	DSM MonoPhos™ Ligand Kit.....	509
96-3700	EnantioTech BIMAHLigand Kit for Asymmetric Hydrogenation.....	510
96-4100	Garphos™ Ligand Kit.....	510
96-3760	NHC Ligand Kit 1: Chiral N-Heterocyclic Carbenes.....	512
96-3765	NHC Ligand Kit 2: "Free" Carbenes.....	512
96-3770	NHC Ligand Kit 3: Variety of N-Heterocyclic Carbenes.....	513
96-3775	NHC Ligand Kit 4: Bis Carbenes.....	514
96-3780	PhenCar-Phos Ligand Kit.....	515
96-1650	Phosphine Ligand Kit for Palladium-Catalyzed Carbon-Carbon and Carbon-Heteroatom Bond Formation.....	515
96-7050	PINAP Ligand Kit.....	516
96-2310	SKP Ligand Kit for asymmetric-allylic amination and cyclopropanation.....	517
96-6651	Solvias cataCXium® Ligand Kit for C-X coupling reactions.....	518
96-3650	Solvias Josiphos Ligand Kit.....	519
96-3652	Solvias MandyPhos™ Ligand Kit.....	521
96-3651	Solvias Walphos Ligand Kit.....	522
96-3655	Solvias (R)-MeO-BIPHEP Ligand Kit.....	523
96-3656	Solvias (S)-MeO-BIPHEP Ligand Kit.....	524
96-0060	Spiro Bisphosphine Ligand Kit.....	525
96-0065	Spiro Monophosphite and Monophosphoramidite Ligand Kit.....	526
96-6950	Takasago BINAP Ligand Kit.....	527
96-6900	Takasago SEGPPOS® Ligand Kit.....	528
96-3740	UREAphos and METAMORPhos Ligand Kit for Asymmetric Hydrogenation.....	529

Metal Scavenging Kits		Page #
96-6700	BASF Metals Scavenging Agent Kit (MSA Kit).....	531
96-6750	PhosphonicS Metals Scavenging Kit.....	531

Nanomaterial Kits		Page #
96-0800	Cadmium selenide CANdot® quantum dot (CdSe core) kit, 50umol/L in hexanes, 525-625nm peak emissions.....	533
96-0813	Cadmium selenide/cadmium sulfide CANdot® quantum rod kit (CdSe/CdS elongated core/shell), 5 mg/ml in hexanes, 560nm, 590nm, 620nm peak emissions.....	533
96-1549	Gold Gemini Nanorods Kit, CTAB Free (Wavelength 650-850 nm).....	534
96-1547	Gold Nanoparticles Kit (5nm-40nm diameter, OD 1, stabilized suspension citrate buffer).....	534
96-1545	Gold Nanoparticles Kit, Reactant-Free (5nm-40nm diameter, OD 1, suspension in phosphate-buffered saline, 515-530nm abs. max.).....	535
96-1530	Gold Nanorods Kit (Axial Diameter - 25 nm, wavelength 550-700 nm).....	535
96-1535	Gold Nanorods Kit (Axial Diameter - 10 nm, wavelength 700-808 nm).....	535
96-1540	Gold Nanospheres Kit (30-90 nm).....	535
96-7410	Graphene Quantum Dots (GQDs) Master Kit.....	536
96-7420	Graphene Quantum Dots(GQDs) Mini Kit (Powders).....	536
96-7425	Graphene Quantum Dots in water (GQDs) Mini Kit (Liquids).....	537

Index of Kits

Other Kits		Page #
96-0350	Biological Hydrogen Peroxide Imaging Kit (FBBBE, CBBE).....	537
96-7054	Cucurbituril Kit.....	539
96-0255	Enzyme carrier Lifetech™ ECRKIT1.....	540
96-1525	Long-Chain n-Alkylphosphonic Acid Kit.....	540
96-0397	Nitric Oxide Sensor (Extracellular) Kit ("NO-ON") (FL2A) (Cell-impermeable NO fluorescent probe).....	540
96-0293	Nitric Oxide Sensor (Intracellular) Kit ("NO-ON") (FL) (Cell-trappable NO fluorescent probe).....	542
96-0396	Nitric Oxide Sensor (Intracellular) Kit ("NO-ON") (FL2E) (Cell-trappable NO fluorescent probe).....	543
96-7052	Paracyclophane Kit.....	544
96-4700	RAFT Agent Kit for controlling polymerizations at the molecular level.....	544

BIOCATALYST KITS - CalB immo KIT™ - Immobilized Enzyme

96-4050

CalB immo KIT™ - Immobilized enzyme**NEW**

Store in dry conditions (2-8°C). Do not freeze. Shelf Life: 1 year;
 Sold in collaboration with Purolite for research purposes only.
 Components also available for individual sale.
 Contains the following:

07-3130	CalB immo Plus™ - Immobilized enzyme	10g	See page 14
07-3142	CalB immo 8285™ - Immobilized enzyme	10g	See page 14
07-3148	CalB immo 8806™ - Immobilized enzyme	10g	See page 14
07-3152	CalB immo 5587™ - Immobilized enzyme	10g	See page 14
07-3155	CalB immo 1090™ - Immobilized enzyme	10g	See page 13
07-3159	CalB immo 5872™ - Immobilized enzyme	10g	See page 14

Item #	Immobilized on	Immobilization	Enzyme activity (PLU/g dry)
07-3130	DVB/methacrylate	Adsorption	>9,000
07-3142	Epoxy/butyl methacrylate	Covelent	>10,000
07-3148	Octadecyl methacrylate	Adsorption	>10,000
07-3152	Styrene/DVB copolymer	Adsorption	>4,000
07-3155	Macroporous styrene/DVB	Adsorption	>8,000
07-3159	Styrene/DVB	Adsorption	>3,500

Appearance: White to slightly yellow spherical beads, free from foreign matter

Principal Applications: Screening of immobilized lipases for process development, Esterifications (regio- and stereo-selective), Transesterification, Amidation, Fats and oils modification

Advantages: Fast screening in process development, Wide selection of enzyme carriers for different applications

BIOCATALYST KITS - Lipase immo Kit - Immobilized Enzymes

96-4065

Lipase immo Kit - Immobilized enzymes**NEW**

The KIT contains 10g of each of the following:

- CalB immo Plus™ (Lipase from *Candida antarctica* B)*07-3130*
- CalA immo (Lipase from *Candida antarctica* A)
- TL immo (Lipase from *Thermomyces lanuginosa*)
- RM immo (Lipase from *Rhizomucor miehei*)
- CR immo (Lipase from *Candida rugosa*)
- PS immo (Lipase from *Pseudomonas cepacia*)

A selection of immobilized lipases on different Lifetech™ ECR enzyme carrier resins for screening purposes.

Store in dry conditions (2-8°C). Do not freeze.

Sold in collaboration with Purolite for research purposes only.

Principal Applications: Esterifications (regio- and stereo-selective), Transesterification, Kinetic resolution of racemic alcohols, amines, esters and triacylglycerides, Fats and oils modification, Hydrolysis of esters

Advantages: Fast screening in process development, Wide selection of immobilized lipases, Optimal for all applications in organic solvents.

BIOCATALYST KITS - Novozymes Endoprotease Screening Kit

96-0224

Novozymes Endoprotease Screening Kit (contains 6 endoprotease enzymes)**NEW**

Store at 0-10°C. DO NOT FREEZE. Sold in collaboration with Novozymes A/S. Novozymes does not promote nor support the use of enzymes as Active Pharmaceutical Ingredients or excipients. www.strem.com/novozymes
Components also available for individual sale.

Contains the following:

06-3110	Alcalase® 2.4 L FG (9014-01-1)	10g	See page 13
06-3112	Alcalase® 2.5 L (9014-01-1)	10g	See page 13
06-3115	Esperase® 8.0 L (9014-01-1)	10g	See page 20
06-3137	Savinase® 12 T (9014-01-1)	10g	See page 22
06-3150	Savinase® 16 L (9014-01-1)	10g	See page 22
06-3160	Neutrase® 0.8 L (9080-56-2)	10g	See page 21

Item#	Density	Activity	Formulation	Optimal Conditions	Substrate Specificity
06-3110	1.17	2.4 AU-A/g	Liquid	30-65°C, pH 7-9	Serine endopeptidase
06-3112	1.08	2.5 AU-A/g	Liquid	30-65°C, pH 7-10	Serine endopeptidase
06-3115	1.07	8 KNPU-E/g	Liquid	pH 8-12.5	Serine endopeptidase
06-3137	1.13	12 KNPU S/g	Granulate	30-70°C, pH 8-10	Serine endopeptidase
06-3150	1.16	16 KNPU S/g	Liquid	30-70°C, pH 8-10	Serine endopeptidase
06-3160	1.26	0.8 AU/g	Liquid	40-50°C, pH 7	Metalloprotease

Optimal storage is 0-10°C/32-50°F. If stored above 25°C/77°F the samples should be used within 3 months.

BIOCATALYST KITS - Novozymes Lipase Screening Kit

96-0220

Novozymes Lipase Screening Kit (contains 9 lipase enzymes)**NEW**

Store at 0-10°C. DO NOT FREEZE. Sold in collaboration with Novozymes A/S. Novozymes does not promote nor support the use of enzymes as Active Pharmaceutical Ingredients or excipients. www.strem.com/novozymes
Components also available for individual sale.

Contains the following:

06-3100	NovoCor® AD L (9001-62-1)	10g	See page 21
06-3105	Lipozyme® CALB L (9001-62-1)	10g	See page 20
06-3118	Palatase® 20000 L (9001-62-1)	5g	See page 22
06-3120	Novozym® 40086 (9001-62-1)	5g	See page 21
06-3123	Novozym® 435 (9001-62-1)	5g	See page 21
06-3125	Resinase® HT (9001-62-1)	10g	See page 22
06-3135	Novozym® 51032 (9001-62-1)	10g	See page 21
06-3140	Lipozyme® TL 100 L (9001-62-1)	10g	See page 20
06-3155	Lipozyme® TL IM (9001-62-1)	10g	See page 21

Item#	Density	Activity	Formulation	Optimal Conditions	Substrate Specificity
06-3100	1.17	6000 LU/g	Liquid	30-60°C, pH 5-9	Sterically hindered esters
06-3105	1.20	5000 LU/g	Liquid	30-60°C, pH 5-9	Esters and alcohols
06-3118	1.19	20000 LU/g	Liquid	30-50°C, pH 7-10	Esters
06-3120	0.33	275 IUN/g	Immobilized Granulate	30-50°C, pH 7-10	Esters
06-3123	0.40	10000 PLU/g	Immobilized Granulate	30-60°C, pH 5-9	Esters and alcohols
06-3125	1.05	50 KLU/g	Liquid	up to 90°C, pH 5-8	Esters
06-3135	1.04	15 KLU/g	Liquid	35-70°C, pH 7-10	Esters
06-3140	1.05	100 KLU/g	Liquid	20-50°C, pH 7-10	Esters and diesters
06-3155	0.40	250 IUN/g	Immobilized Granulate	50-75°C, pH 6-8	Esters

Optimal storage is 0-10°C/32-50°F. If stored above 25°C/77°F the samples should be used within 3 months.

BIOCATALYST KITS - Provivi Carbene/Nitrene Transferase Screening Kit

96-1580

Provivi Carbene/Nitrene Transferase Screening Kit

Store dry at -20°C. Sold under license from Provivi for research purposes only.

NEW

HAZ

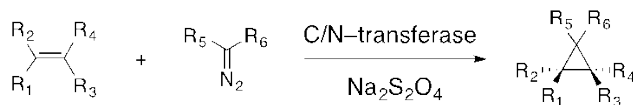
1. Reactions Catalyzed

Synthesis of cyclopropanes via carbene transfer catalyzed by carbene/nitrene transferases.

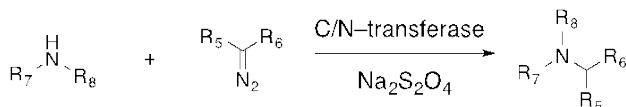

Synthesis of substituted amines via carbene transfer catalyzed by carbene/nitrene transferases.

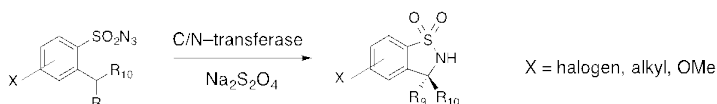

Synthesis of substituted benzosultams via nitrene transfer catalyzed by carbene/nitrene transferases.

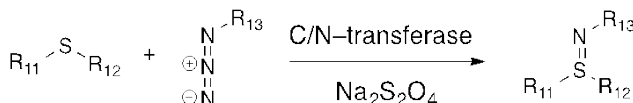

Synthesis of sulfimides via nitrene transfer catalyzed by carbene/nitrene transferases.

2. Provivi C/N Transferase Screening Kit General Information

Provivi's proprietary enzymes can efficiently activate diazo and azide compounds to generate iron-carbenoids and iron-nitrenoids, respectively, through a mode of activation that has never been observed in nature. These intermediates can then react with a variety of substrates such as olefins, N-H bonds, C-H bonds, and sulfides, offering wide synthetic utility. After identifying initial activity on a reaction of interest, these enzymes can be further engineered and optimized (e.g. via directed evolution) to achieve high activity and stereoselectivity for a reaction of interest.

All reactions are best performed under anaerobic conditions. Cyclopropanes are synthesized by the reaction of a diazo carbene precursor (e.g. ethyl diazoacetate) with an olefin in the presence of a carbene/nitrene transferase as catalyst. The cyclopropanation instructions described in this technical note can be readily adapted for the other carbene and nitrene transfer reactions outlined above.

3. Provivi C/N Transferase Screening Kit Contents

- 24 vials (2 vials of each of 12 different enzymes, containing 50 nMoles of enzyme, enough for two screens) packed as lyophilized powders containing potassium phosphate in 2 ml screwcap vials
- 2 x 20 ml bottles containing 0.12 mMoles (25 mg) of 85% sodium dithionite (sodium hydrosulfite)

Each kit contains 12 different carbene/nitrene transfer enzymes as lyophilized powders together with potassium phosphate buffer. When reconstituted by the addition of deionized water and sodium dithionite as specified in the Screening Protocol in Section 4, each enzyme will be ready for immediate use under the desired reaction screening conditions: 50 nM/ml enzyme in 50mM potassium phosphate buffer, 10 mM sodium dithionite, pH 7.

Enzymes	PRVV-009	PRVV-010	PRVV-011	PRVV-013	PRVV-019	PRVV-032
		PRVV-034	PRVV-036	PRVV-040	PRVV-041	PRVV-042

The enzymes should be stored dry at -20°C, and should be stable for more than 1 year under these conditions. We recommend that solutions of the enzymes be used the same day as they are prepared and not stored for extended periods of time. If storage of enzyme solutions is needed, we recommend storage at 4°C for periods of 1-2 days. For longer periods we recommend flash freezing the solutions and storage at -20°C.

BIOCATALYST KITS - Provivi Carbene/Nitrene Transferase Screening Kit**4. Screening Protocol**

1. Add 12ml of deionized (DI) water to the bottle containing sodium sithionite and dissolve by inversion.
2. Purge the sodium dithionite solution with nitrogen or argon by bubbling for 5 minutes. Sodium dithionite solutions should be made immediately prior to use and kept anaerobic, as sodium dithionite undergoes air oxidation over time.
3. Add 1 ml of purged dithionite solution to each enzyme vial.
4. Add alkene (either neat or dissolved as 20% w/v in methanol or ethanol) to achieve a 1% w/v final concentration (50 microliters of a 20% methanol/ethanol solution; final concentration of 10 mg alkene per ~1 ml reaction mixture). Do not worry if the alkene is not completely soluble. The reaction should still take place.
5. Add the diazo compound last (either neat or dissolved as 20% w/v in methanol or ethanol; ethyl diazoacetate is the most common choice and recommended as a positive control if another carbene precursor is used) to achieve 0.5% w/v final concentration (25 microliters of a 20% methanol/ethanol solution; 5mg diazo compound per ~1 ml reaction mixture) to initiate the reaction.
6. Allow reaction to proceed with mixing by shaking up to 800 rpm, taking samples at regular time points to analyze for product formation starting at 30 minutes. The reaction should be largely complete within 1-2 hours.
7. Samples may be quenched by the addition of each time point sample to an equal volume of extraction solvent (dichloromethane, hexane, and similar are recommended) for analysis by GC or HPLC. For a 1 ml reaction volume, samples of 0.2 ml can be withdrawn and diluted into 0.2 ml extraction solvent. If the product is water soluble, and/or if analysis will be by HPLC, quenching can be done by dilution of the sample into an equal volume of acetonitrile.

For tech support and questions: enzymes@provivi.com

5. Recommended Literature

Farwell, C.C., McIntosh, J.A., Hyster, T.K., Wang, Z.J. & Arnold, F.H., Enantioselective Imidation of Sulfides via Enzyme-Catalyzed Intermolecular Nitrogen-Atom Transfer *Journal of the American Chemical Society* **136**, 8766-8771 (2014).

Wang, Z.J., Renata, H., Peck, N.E., Farwell, C.C., Coelho, P.S. & Arnold, F.H., Improved Cyclopropanation Activity of Histidine-Ligated Cytochrome P450 Enables the Enantioselective Formal Synthesis of Levomilnacipran. *Angewandte Chemie Int Ed.* **126**, 6928-6931 (2014).

Wang, Z.J., Peck, N.E., Renata, H. & Arnold, F.H., Cytochrome P450-Catalyzed Insertion of Carbenoids into N-H Bonds. *Chemical Science (Royal Society of Chemistry : 2010)* **5**, 598-601 (2014).

Coelho, P.S., Brustad, E.M., Kannan, A. & Arnold, F.H., Olefin Cyclopropanation via Carbene Transfer Catalyzed by Engineered Cytochrome P450 Enzymes. *Science (New York, N. Y.)* **339**, 307-310 (2013).

Coelho, P.S., Wang, Z.J., Ener, M.E., Baril, S.A., Kannan, A., Arnold, F.H. & Brustad, E.M., A serine-substituted P450 catalyzes highly efficient carbene transfer to olefins in vivo. *Nature Chemical Biology* **9**, 485-487 (2013).

McIntosh J. A., Coelho, P.S., Farwell, C.C., Wang, Z.J., Lewis, J.C., Brown, T.R. & Arnold, F.H., Enantioselective intramolecular C-H amination catalyzed by engineered cytochrome P450 enzymes in vitro and in vivo. *Angewandte Chemie (International ed. in English)* **52**, 9309-9312 (2013).

CATALYST & ORGANOCATALYST KITS - Apeiron Ruthenium Metathesis Catalyst Kit

96-0400

Apeiron Ruthenium Metathesis Catalyst Kit

Sold in collaboration with Apeiron Synthesis, Inc.

Components also available for individual sale. Contains the following:

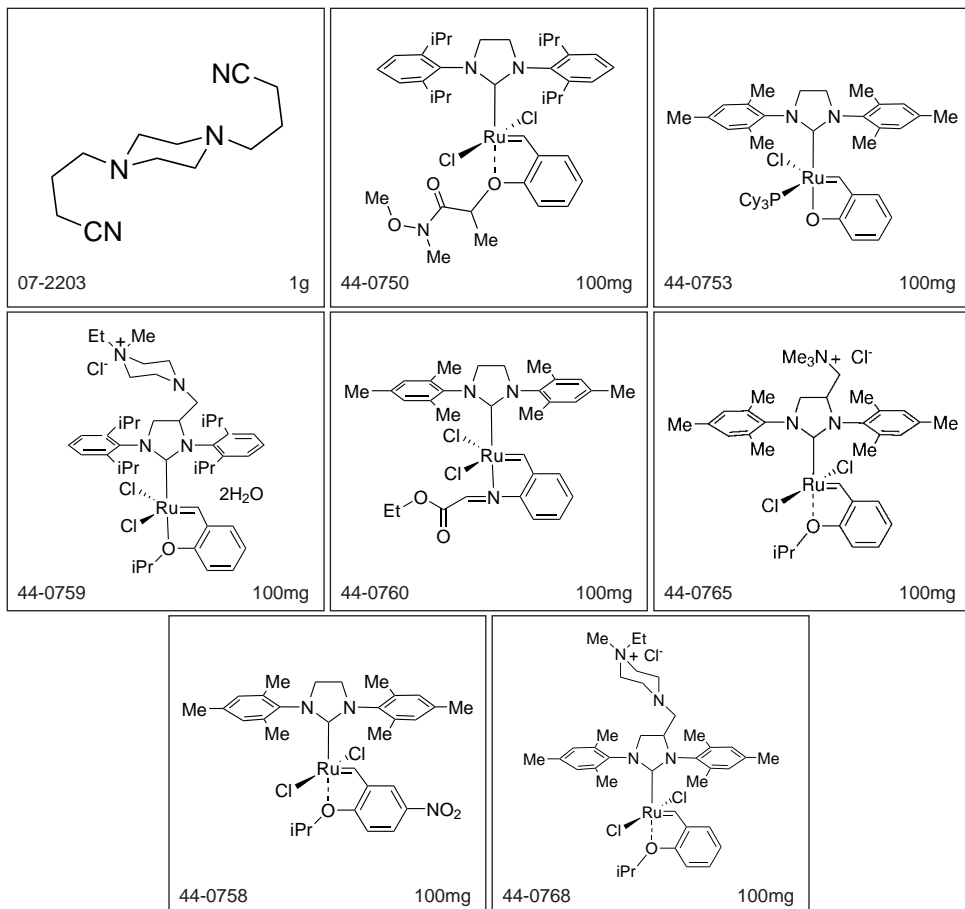
NEW

07-2203	1,4-Bis(2-isocyanopropyl)piperazine (ShatchCat Metal Scavenger) (51641-96-4)	1g	See page 128
44-0750	[1,3-Bis(2,6-di-i-propylphenyl)imidazolidin-2-ylidene] {2-[(1-methoxy(methyl)amino)-1-oxopropan-2-yl]oxy}benzylidene} ruthenium(II) dichloride GreenCat (1448663-06-6)	100mg	See page 365
44-0753	[1,3-Bis(2,4,6-trimethylphenyl)imidazolidin-2-ylidene] (tricyclohexylphosphine)-(2-oxobenzylidene)ruthenium(II) chloride LatMet (1407229-58-6)	100mg	See page 368
44-0758	[1,3-Bis(2,4,6-trimethylphenyl)imidazolidin-2-ylidene]-(2-i-propoxy-5-nitrobenzylidene)ruthenium(II) dichloride Nitro-Grela (502964-52-5)	100mg	See page 365
44-0759	(1,3-Bis(2,6-diisopropylphenyl)-4-((4-ethyl-4-methylpiperazin-1-ium-1-yl)methyl)imidazolidin-2-ylidene)(2-isopropoxybenzylidene) ruthenium(II) chloride dihydrate FixCat (1799947-97-9)	100mg	See page 391
44-0760	Dichloro(1,3-dimesitylimidazolidin-2-ylidene){2-[(ethoxy-2-oxoethylidene)amino]benzylidene} ruthenium(II) HeatMet	100mg	See page 368
44-0765	[1,3-Bis(2,4,6-trimethylphenyl)-4-[(trimethylammonio)methyl]imidazolidin-2-ylidene]-(2-i-propoxybenzylidene)dichlororuthenium(II) chloride StickyCat Cl (1452227-72-3)	100mg	See page 367
44-0768	[1,3-Bis(2,4,6-trimethylphenyl)-4-[(4-ethyl-4-methylpiperazin-1-ium-1-yl)methyl]imidazolidin-2-ylidene]-(2-i-propoxybenzylidene) dichlororuthenium(II) chloride AquaMet (1414707-08-6)	100mg	

CATALYST & ORGANOCATALYST KITS - BASF Blocking Group Removal Catalyst Kit**96-6715 BASF Blocking Group Removal Catalyst Kit**

Sold in collaboration with BASF for research purposes only.

Components also available for individual sale.

Contains the following:

46-1905	Palladium, 10% on activated wood carbon, reduced, 50% water wet (Escat™ 1931) (7440-05-3)	10g	See page 224
46-1906	Palladium, 10% on activated wood carbon, unreduced, 50% water wet (Escat™ 1921) (7440-05-3)	10g	See page 224
46-1907	Palladium, 3% on activated carbon, reduced, 50% water wet paste (Escat™ 1911) (7440-05-3)	10g	See page 222
46-1908	Palladium, 5% on activated carbon, reduced, 50% water wet paste (Escat™ 1941) (7440-05-3)	10g	See page 222
46-1909	Palladium, 5% on activated carbon, reduced, 50% water wet paste (Escat™ 1961) (7440-05-3)	10g	See page 222
46-1911	Palladium, 5% on activated carbon, reduced, 50% water wet paste (Escat™ 1971) (7440-05-3)	10g	See page 222

CATALYST & ORGANOCATALYST KITS - BASF Heterogeneous Catalyst Kit**96-6717 BASF Heterogeneous Catalyst Kit**

HAZ

Product offered is commercial grade, sold in collaboration with BASF for research purposes only.

Components also available for individual sale.

Contains the following:

44-4065	Ruthenium, 5% on activated carbon, reduced, 50% water wet paste (Escat™ 4401) (7440-18-8)	5g	See page 362
45-1875	Rhodium, 5% on activated wood carbon, reduced, 50% water wet paste (Escat™ 3401) (7440-16-6)	1g	See page 348
46-1707	Palladium, 20% on activated carbon (Pearlman's catalyst), unreduced, 50% water wet paste (Escat™ 1951) (7440-05-3)	5g	See page 222
46-1710	Palladium, 0.6% on activated carbon, 50% water-wet paste (NanoSelect LF 100) (7440-05-3)	5g	See page 223
46-1901	Palladium, 5% on activated peat carbon, reduced, 50% water wet paste (Escat™ 1621) (7440-05-3)	10g	See page 223
46-1902	Palladium, 5% on activated wood carbon, reduced, dry (Escat™ 1431) (7440-05-3)	10g	See page 223
46-1903	Palladium, 5% on activated wood carbon, reduced, 50% water wet paste (Escat™ 1421) (7440-05-3)	10g	See page 224
46-1904	Palladium, 5% on activated wood carbon, unreduced, 50% water wet paste (Escat™ 1471) (7440-05-3)	10g	See page 224
46-1905	Palladium, 10% on activated wood carbon, reduced, 50% water wet (Escat™ 1931) (7440-05-3)	10g	See page 224
46-1951	Palladium, 5% on alumina powder, reduced, dry (Escat™ 1241) (7440-05-3)	5g	See page 224
78-1611	Platinum, 5% on activated wood carbon, reduced, dry (Escat™ 2431) (7440-06-4)	5g	See page 334
78-1612	Platinum, 5% on activated wood carbon, reduced, 50% water wet paste (Escat™ 2421) (7440-06-4)	5g	See page 334
78-1613	Platinum, 5% on activated carbon, unreduced, 50% water wet paste (Escat™ 2441) (7440-06-4)	5g	See page 334

CATALYST & ORGANOCATALYST KITS - BASF Palladium Catalyst Kit

96-6719 HAZ	BASF Palladium Catalyst Kit Product offered is commercial grade, sold in collaboration with BASF for research purposes only. Components also available for individual sale. Contains the following:		
46-1707	Palladium, 20% on activated carbon (Pearlman's catalyst), unreduced, 50% water wet paste (Escat™ 1951) (7440-05-3)	5g	See page 222
46-1710	Palladium, 0.6% on activated carbon, 50% water-wet paste (NanoSelect LF 100) (7440-05-3)	5g	See page 223
46-1901	Palladium, 5% on activated peat carbon, reduced, 50% water wet paste (Escat™ 1621) (7440-05-3)	10g	See page 223
46-1902	Palladium, 5% on activated wood carbon, reduced, dry (Escat™ 1431) (7440-05-3)	10g	See page 223
46-1903	Palladium, 5% on activated wood carbon, reduced, 50% water wet paste (Escat™ 1421) (7440-05-3)	10g	See page 224
46-1904	Palladium, 5% on activated wood carbon, unreduced, 50% water wet paste (Escat™ 1471) (7440-05-3)	10g	See page 224
46-1905	Palladium, 10% on activated wood carbon, reduced, 50% water wet (Escat™ 1931) (7440-05-3)	10g	See page 224
46-1906	Palladium, 10% on activated wood carbon, unreduced, 50% water wet (Escat™ 1921) (7440-05-3)	10g	See page 224
46-1951	Palladium, 5% on alumina powder, reduced, dry (Escat™ 1241) (7440-05-3)	5g	See page 224

CATALYST & ORGANOCATALYST KITS - BASF Platinum Catalyst Kit

96-6721 HAZ	BASF Platinum Catalyst Kit Product offered is commercial grade, sold in collaboration with BASF for research purposes only. Components also available for individual sale. Contains the following:		
78-1611	Platinum, 5% on activated wood carbon, reduced, dry (Escat™ 2431) (7440-06-4)	5g	See page 334
78-1612	Platinum, 5% on activated wood carbon, reduced, 50% water wet paste (Escat™ 2421) (7440-06-4)	5g	See page 334
78-1613	Platinum, 5% on activated carbon, unreduced, 50% water wet paste (Escat™ 2441) (7440-06-4)	5g	See page 334
78-1614	Platinum, 3% on activated wood carbon, reduced, 70% water wet paste (Escat™ 2931) (7440-06-4)	5g	See page 334
78-1661	Platinum, 5% on alumina powder, reduced, dry (Escat™ 2941) (7440-06-4)	5g	See page 334
78-1892	Platinum(IV) oxide hydrate (~80-82% Pt) (99.95+%-Pt) ADAMS' CATALYST [BASF C7018] (52785-06-5)	1g	See page 338

CATALYST & ORGANOCATALYST KITS - [1,1'-Bis(dialkyl/diarylphosphino)ferrocene]palladium(II) dichloro Catalyst Kit

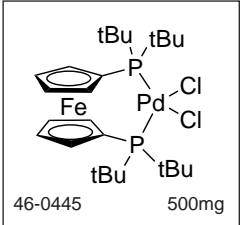
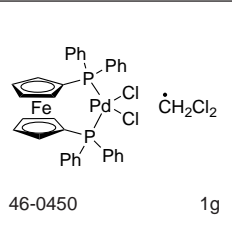
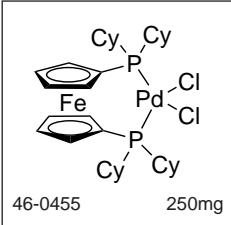
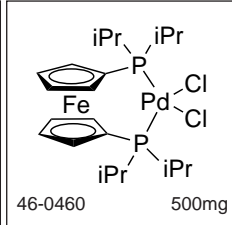
96-3735	[1,1'-Bis(dialkyl/diarylphosphino)ferrocene]palladium(II) dichloro Catalyst Kit Components also available for individual sale. Contains the following:		
	46-0445	500mg	
	46-0450	1g	
	46-0455	250mg	
	46-0460	500mg	
46-0445	Dichloro[1,1'-bis(di-t-butylphosphino)ferrocene]palladium(II), 99% (95408-45-0)	500mg	See page 236
46-0450	Dichloro 1,1'-bis(diphenylphosphino)ferrocene palladium (II) dichloromethane, 99% (95464-05-4)	1g	See page 238
46-0455	Dichloro[1,1'-bis(dicyclohexylphosphino)ferrocene]palladium(II), dichloromethane adduct, 99% (917511-90-1)	250mg	See page 237
46-0460	Dichloro[1,1'-bis(di-i-propylphosphino)ferrocene]palladium(II), 99% (215788-65-1)	500mg	See page 238

CATALYST & ORGANOCATALYST KITS - Buchwald Palladacycle Precatalyst Kit 1

96-5503 **Buchwald Palladacycle Precatalyst Kit 1**
(Chloro-2-aminoethylphenyl- Palladacycles Gen. 1)
 Patents US 6,395,916, US 6,307,087.
 Components also available for individual sale.
 Contains the following:

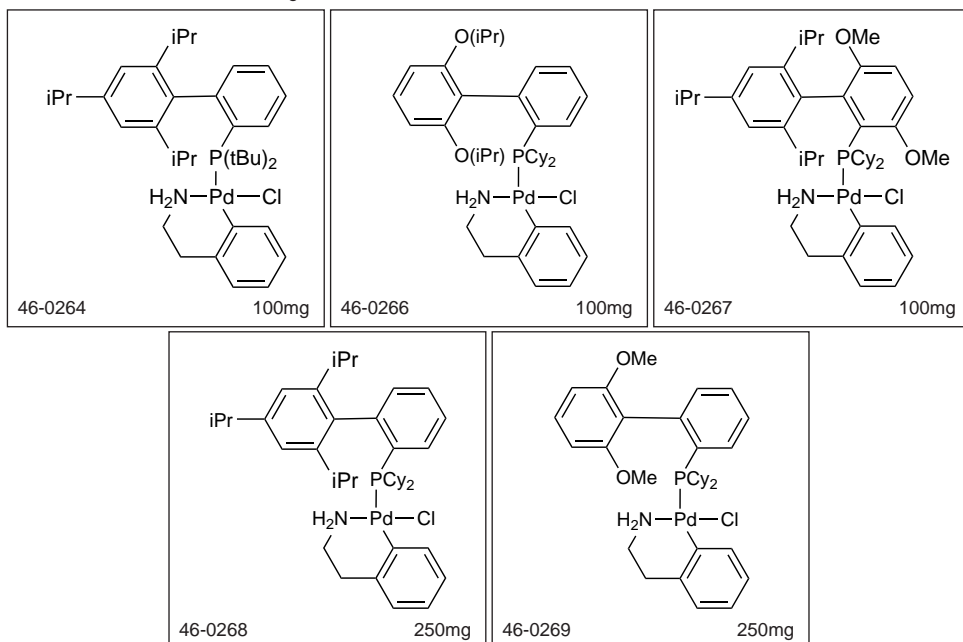

46-0264	Chloro(2-di- <i>t</i> -butylphosphino-2',4',6'-tri- <i>i</i> -propyl-1,1'-biphenyl)[2-(2-aminoethyl)phenyl] palladium(II), min. 98% [<i>t</i> -BuXPhos Palladacycle Gen. 1] (1142811-12-8)	100mg	See page 231
46-0266	Chloro(2-dicyclohexylphosphino-2',6'-di- <i>i</i> -propoxy-1,1'-biphenyl)[2-(2-aminoethyl)phenyl]palladium(II), methyl- <i>t</i> -butylether adduct, min. 98% [RuPhos Palladacycle Gen. 1] (1028206-60-1)	100mg	See page 232
46-0267	Chloro[2-(dicyclohexylphosphino)-3,6-dimethoxy-2',4',6'-tri- <i>i</i> -propyl-1,1'-biphenyl][2-(2-aminoethyl)phenyl]palladium(II), min. 98% [BrettPhos Palladacycle Gen. 1] (1148148-01-9)	100mg	See page 231
46-0268	Chloro(2-dicyclohexylphosphino-2',4',6'-tri- <i>i</i> -propyl-1,1'-biphenyl)[2-(2-aminoethyl)phenyl] palladium(II) methyl- <i>t</i> -butylether adduct, min. 98% [XPhos Palladacycle Gen. 1] (1028206-56-5)	250mg	See page 232
46-0269	Chloro(2-dicyclohexylphosphino-2',6'-dimethoxy-1,1'-biphenyl)[2-(2-aminoethyl)phenyl]palladium(II) methyl- <i>t</i> -butylether adduct, min. 98% [SPhos Palladacycle Gen. 1] (1028206-58-7)	250mg	See page 231

CATALYST & ORGANOCATALYST KITS - Buchwald Palladacycle Precatalyst Kit 3

96-5508 **Buchwald Palladacycle Precatalyst Kit 3 (Chloro-2'-amino-1,1'-biphenyl-2-yl - Palladacycles Gen. 2)**
 Patents: US 6,395,916, US 6,307,087.
 Components also available for individual sale.
 Contains the following:

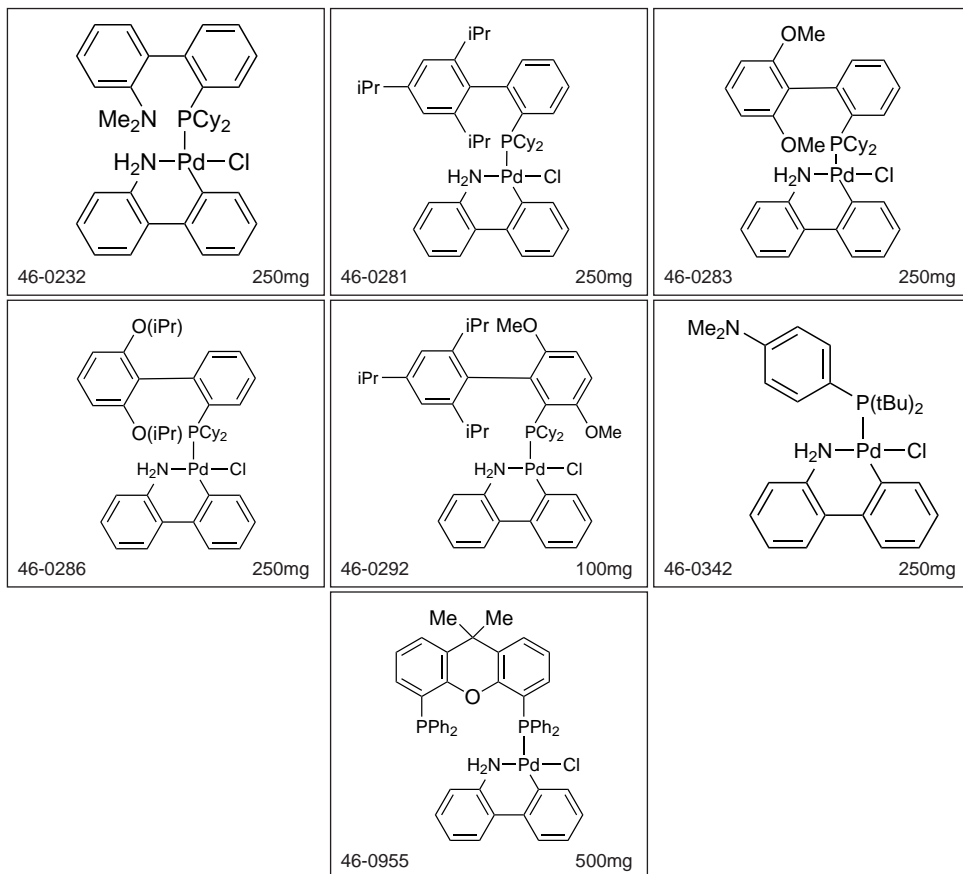

46-0232	Chloro[2-(dicyclohexylphosphino)-2'-(N,N-dimethylamino)-1,1'-biphenyl](2'-amino-1,1'-biphenyl-2-yl)palladium(II), min. 98% [DavePhos Palladacycle Gen. 2]	250mg	See page 232
46-0281	Chloro[2-(dicyclohexylphosphino)-2',4',6'-tri-i-propyl-1,1'-biphenyl](2'-amino-1,1'-biphenyl-2-yl)palladium(II), min. 98% [XPhos Palladacycle Gen. 2] (1310584-14-5)	250mg	See page 232
46-0283	Chloro[2-(dicyclohexylphosphino)-2',6'-dimethoxy-1,1'-biphenyl](2'-amino-1,1'-biphenyl-2-yl)palladium(II) min. 98% [SPhos Palladacycle Gen. 2] (1375325-64-6)	250mg	See page 231
46-0286	Chloro[2-(dicyclohexylphosphino)-2',6'-di-i-propoxy-1,1'-biphenyl](2'-amino-1,1'-biphenyl-2-yl)palladium(II), min. 98% [RuPhos Palladacycle Gen. 2] (1375325-68-0)	250mg	See page 232
46-0292	Chloro[2-(dicyclohexylphosphino)-3,6-dimethoxy-2',4',6'-tri-i-propyl-1,1'-biphenyl](2'-amino-1,1'-biphenyl-2-yl)palladium(II), min. 98% [BrettPhos Palladacycle Gen. 2] (1451002-39-3)	100mg	See page 231
46-0342	Chloro[[4-(N,N-dimethylamino)phenyl]di-tert-butylphosphino](2'-amino-1,1'-biphenyl-2-yl)palladium(II), min. 98% [Amphos Palladacycle Gen. 2]	250mg	See page 233
46-0955	Chloro[9,9-dimethyl-4,5-bis(diphenylphosphino)xanthene][2'-amino-1,1'-biphenyl]palladium(II) dichloromethane adduct, min. 98% [Xantphos Palladacycle Gen. 2] (1375325-77-1)	500mg	See page 233

CATALYST & ORGANOCATALYST KITS - Buchwald Palladacycle Precatalyst Kit 2a

96-5505 Buchwald Palladacycle Precatalyst Kit 2a (Methanesulfonato-2'-amino-1,1'-biphenyl-2-yl- Palladacycles Gen. 3)

Patents: US 6,395,916, US 6,307,087.

Components also available for individual sale.

Contains the following:

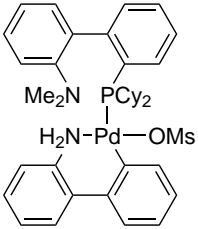
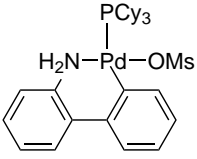
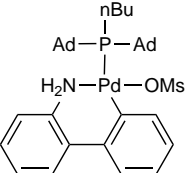
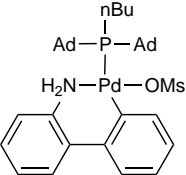
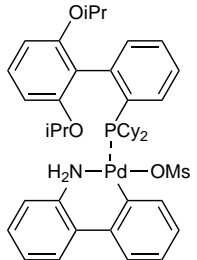
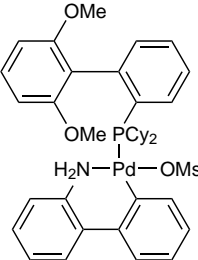
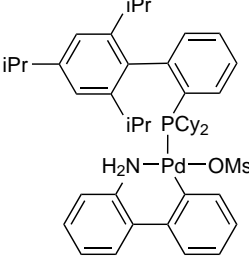
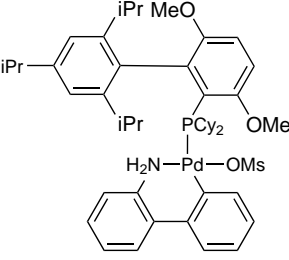
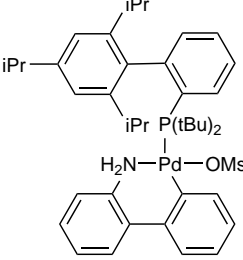
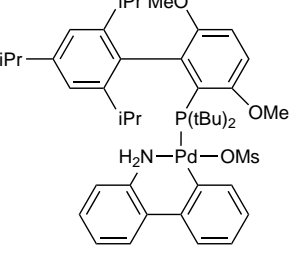
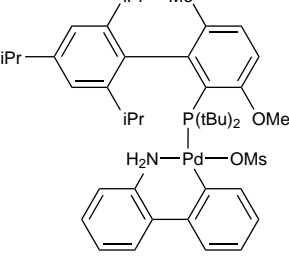
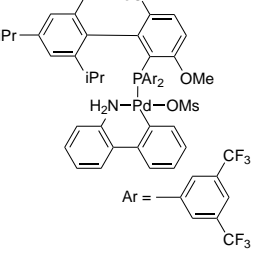
 <p>46-0237 250mg</p>	 <p>46-0239 250mg</p>	 <p>46-0278 250mg</p>
 <p>46-0278 250mg</p>	 <p>46-0314 250mg</p>	 <p>46-0318 250mg</p>
 <p>46-0320 250mg</p>	 <p>46-0322 100mg</p>	 <p>46-0323 250mg</p>
 <p>46-0325 100mg</p>	 <p>46-0335 100mg</p>	 <p>46-0340 100mg</p>

CATALYST & ORGANOCATALYST KITS - Buchwald Palladacycle Precatalyst Kit 2a

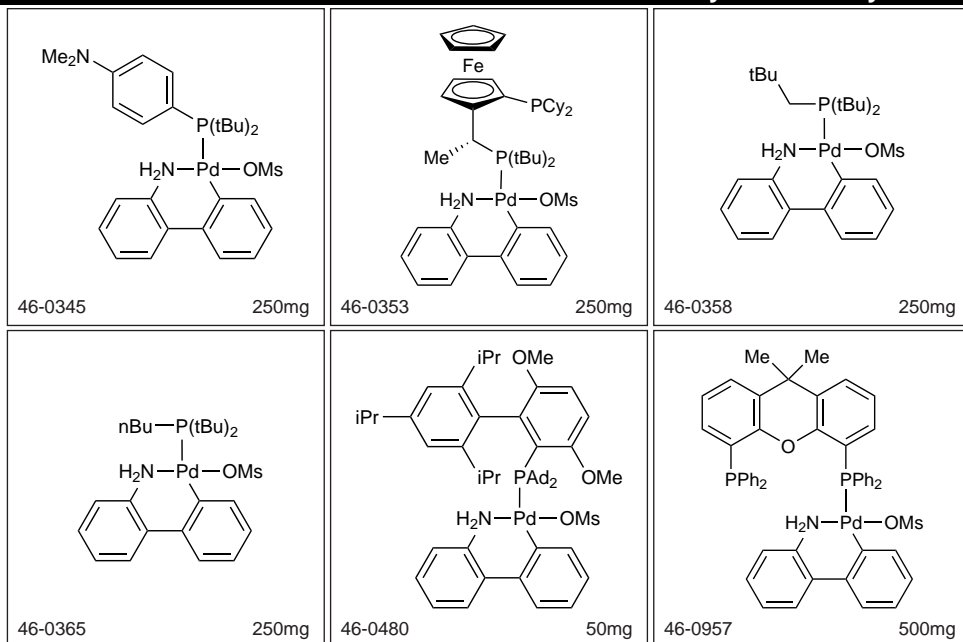

46-0237	Methanesulfonato[2-(dicyclohexylphosphino)-2'-(N,N-dimethylamino)-1,1'-biphenyl](2'-amino-1,1'-biphenyl-2-yl)palladium(II) CH ₂ Cl ₂ adduct, min. 98% [DavePhos Palladacycle Gen. 3] (1445085-87-9)	250mg	See page 244
46-0239	Methanesulfonato(tricyclohexylphosphine)(2'-amino-1,1'-biphenyl-2-yl)palladium(II) dichloromethane adduct, min. 98% [PCy ₃ Palladacycle Gen. 3] (1445086-12-3)	250mg	See page 246
46-0278	Methanesulfonato(diadamantyl-n-butylphosphino)-2'-amino-1,1'-biphenyl-2-yl)palladium(II) dichloromethane adduct, min. 95% [cataCXium® A Palladacycle Gen. 3]	250mg	See page 241
46-0314	Methanesulfonato(2-dicyclohexylphosphino-2',6'-di-i-propoxy-1,1'-biphenyl)(2'-amino-1,1'-biphenyl-2-yl)palladium(II), min. 98% [RuPhos Palladacycle Gen. 3] (1445085-77-7)	250mg	See page 244
46-0318	Methanesulfonato(2-dicyclohexylphosphino-2',6'-dimethoxy-1,1'-biphenyl)(2'-amino-1,1'-biphenyl-2-yl)palladium(II) dichloromethane adduct min. 98% [SPhos Palladacycle Gen. 3] (1445085-82-4)	250mg	See page 243
46-0320	Methanesulfonato(2-dicyclohexylphosphino-2',4',6'-tri-i-propyl-1,1'-biphenyl)(2'-amino-1,1'-biphenyl-2-yl)palladium(II) dichloromethane adduct, min. 98% [Xphos Palladacycle Gen. 3] (1445085-55-1)	250mg	See page 245
46-0322	Methanesulfonato(2-dicyclohexylphosphino-3,6-dimethoxy-2',4',6'-tri-i-propyl-1,1'-biphenyl)(2'-amino-1,1'-biphenyl-2-yl)palladium(II), min. 98% [BrettPhos Palladacycle Gen. 3] (1470372-59-8)	100mg	See page 244
46-0323	Methanesulfonato(2-di-t-butylphosphino-2',4',6'-tri-i-propyl-1,1'-biphenyl)(2'-amino-1,1'-biphenyl-2-yl)palladium(II), min. 98% [t-BuXPhos Palladacycle Gen. 3] (1447963-75-8)	250mg	See page 243
46-0325	Methanesulfonato(2-(di-t-butylphosphino)-3,6-dimethoxy-2',4',6'-tri-i-propyl-1,1'-biphenyl)(2'-amino-1,1'-biphenyl-2-yl)palladium(II), dichloromethane adduct, min. 98% [t-BuBrettPhos Palladacycle Gen. 3] (1536473-72-9)	100mg	See page 242
46-0335	Methanesulfonato(2-(di-t-butylphosphino)-3-methoxy-6-methyl-2',4',6'-tri-i-propyl-1,1'-biphenyl)(2'-amino-1,1'-biphenyl-2-yl)palladium(II), min. 98% [RockPhos Palladacycle Gen. 3] (2009020-38-4)	100mg	See page 242
46-0340	Methanesulfonato[2-bis(3,5-di(trifluoromethyl)phenyl)phosphino]-3,6-dimethoxy-2',4',6'-tri-i-propyl-1,1'-biphenyl)(2'-amino-1,1'-biphenyl-2-yl)palladium(II), min. 98% [JackiePhos Palladacycle Gen. 3]	100mg	See page 241

CATALYST & ORGANOCATALYST KITS - Buchwald Palladacycle Precatalyst Kit 2a

46-0345	Methanesulfonato[[4-(N,N-dimethylamino)phenyl]di-t-butylphosphino](2'-amino-1,1'-biphenyl-2-yl)palladium(II), min. 98% [Amphos Palladacycle Gen. 3] (1820817-64-8)	250mg	See page 245
46-0353	Methanesulfonato[(R)-(-)-1-[(S)-2-(dicyclohexylphosphino)ferrocenyl]ethyl]di-t-butylphosphino(2'-amino-1,1'-biphenyl-2-yl)palladium(II), min. 98% [Josiphos Palladacycle Gen. 3] (1702311-34-9)	100mg	See page 245
46-0358	Methanesulfonato(di-t-butylneopentylphosphino)(2'-amino-1,1'-biphenyl-2-yl)palladium(II), min. 98% [DTBNpP Palladacycle Gen. 3] (1507403-89-5)	250mg	See page 242
46-0365	Methanesulfonato[di-t-butyl(n-butyl)phosphino](2'-amino-1,1'-biphenyl-2-yl)palladium(II) dichloromethane adduct, min. 98% [P(t-Bu) ₂ (n-Bu) Palladacycle Gen. 3] (1445086-17-8)	250mg	See page 241
46-0480	Methanesulfonato[2-(di-1-adamantylphosphino)-3,6-dimethoxy-2',4',6'-tri-i-propyl-1,1'-biphenyl](2'-amino-1,1'-biphenyl-2-yl)palladium(II), min. 98% [AdBrettPhos Palladacycle Gen. 3] (1445972-29-1)	50mg	See page 241
46-0957	Methanesulfonato[9,9-dimethyl-4,5-bis(diphenylphosphino)xanthene][2'-amino-1,1'-biphenyl]palladium(II) dichloromethane adduct, min. 98% [Xantphos Palladacycle Gen. 3] (1445085-97-1)	500mg	See page 246

CATALYST & ORGANOCATALYST KITS - Buchwald Palladacycle Precatalyst Kit 2b**96-5506 Buchwald Palladacycle Precatalyst Kit 2b (Methanesulfonato-2'-amino-1,1'-biphenyl-2-yl- Palladacycles Gen. 3)****NEW**

Patents: US 6,395,916, US 6,307,087.
Components also available for individual sale.
Contains the following:

 46-0348 50mg	 46-0357 100mg	 46-0387 250mg	 46-0392 500mg
 46-0487 500mg	 46-0935 250mg	 46-0959 100mg	 46-2128 250mg
 46-2135 250mg	 46-2153 250mg	 46-2158 250mg	 46-2163 100mg

46-0348	Methanesulfonato[2-diethylphosphino-2',6'-bis(dimethylamino)-1,1'-biphenyl](2'-amino-1,1'-biphenyl-2-yl)palladium(II), min. 98% [EtCPhos Palladacycle Gen. 3]	50mg	See page 245
---------	---	------	--------------

CATALYST & ORGANOCATALYST KITS - Buchwald Palladacycle Precatalyst Kit 2b

46-0357	Methanesulfonato(2-di-t-butylphosphino-1,1'-binaphthyl)(2'-amino-1,1'-biphenyl-2-yl)palladium(II), min. 95% [TrixiePhos Palladacycle Gen. 3]	100mg	See page 242
46-0387	Methanesulfonato(tri-t-butylphosphino)(2'-amino-1,1'-biphenyl-2-yl)palladium(II), 98% [P(t-Bu) ₃ Palladacycle Gen. 3] (1445086-17-8)	250mg	See page 246
46-0392	Methanesulfonato(1,3,5,7-tetramethyl-8-phenyl-2,4,6-tri-oxa-8-phosphaadamantane)(2'-amino-1,1'-biphenyl-2-yl)palladium(II) dichloromethane adduct, min. 98% [MeCgPPh Palladacycle Gen. 3]	500mg	See page 246
46-0487	Methanesulfonato(2-dicyclohexylphosphino-2',6'-bis(dimethylamino)-1,1'-biphenyl)(2'-amino-1,1'-biphenyl-2-yl)palladium(II), 98% [CPhos Palladacycle Gen. 3] (1447963-73-6)	100mg	See page 243
46-0935	Methanesulfonato[N-[2-(di-1-adamantylphosphino)phenyl]morpholine](2'-amino-1,1'-biphenyl-2-yl)palladium(II) dichloromethane adduct, min. 98% [Mor-Dalphos Palladacycle Gen. 3]	250mg	See page 241
46-0959	Methanesulfonato[4,6-bis(diphenylphosphino)phenoxazine](2'-amino-1,1'-biphenyl-2-yl)palladium(II), 98% [NiXantphos Palladacycle Gen. 3] (1602922-03-1)	100mg	See page 240
46-2128	Methanesulfonato[1,1'-bis(diphenylphosphino)ferrocene]](2'-amino-1,1'-biphenyl-2-yl)palladium(II), min. 98% [DPPF Palladacycle Gen. 3] (1445086-28-1)	250mg	See page 240
46-2135	Methanesulfonato[2-(di-t-butylphosphino)-2'-(N,N-dimethylamino)-1,1'-biphenyl](2'-amino-1,1'-biphenyl-2-yl)palladium(II) dichloromethane adduct, min. 98% [t-BuDavePhos Palladacycle Gen. 3] (1445085-92-6)	250mg	See page 242
46-2153	Methanesulfonato[2,2'-bis(diphenylphosphino)-1,1'-binaphthyl](2'-amino-1,1'-biphenyl-2-yl)palladium(II), min. 98% [BINAP Palladacycle Gen. 3]	250mg	See page 240
46-2158	Methanesulfonato(1,1'-bis(di-t-butylphosphino)ferrocene)(2'-amino-1,1'-biphenyl-2-yl)palladium(II), min. 98% [DTBPF Palladacycle Gen. 3]	250mg	See page 240
46-2163	Methanesulfonato(2-di-t-butylphosphino-3,4,5,6-tetramethyl-2',4',6'-tri-i-propylbiphenyl)(2'-amino-1,1'-biphenyl-2-yl)palladium(II), min. 95% [Me4 t-ButylXPhos Palladacycle Gen. 3] (1507403-85-1)	100mg	See page 243

CATALYST & ORGANOCATALYST KITS - Buchwald Palladacycle Precatalyst Kit 4

96-5512

Buchwald Palladacycle Precatalyst Kit 4 (Methanesulfonato-2'-methylamino-1,1'-biphenyl-2-yl)- Palladacycles Gen. 4)**NEW**

Patents: PCT/US2013/030779, US Serial No. 13/799620

Components also available for individual sale.

Contains the following:

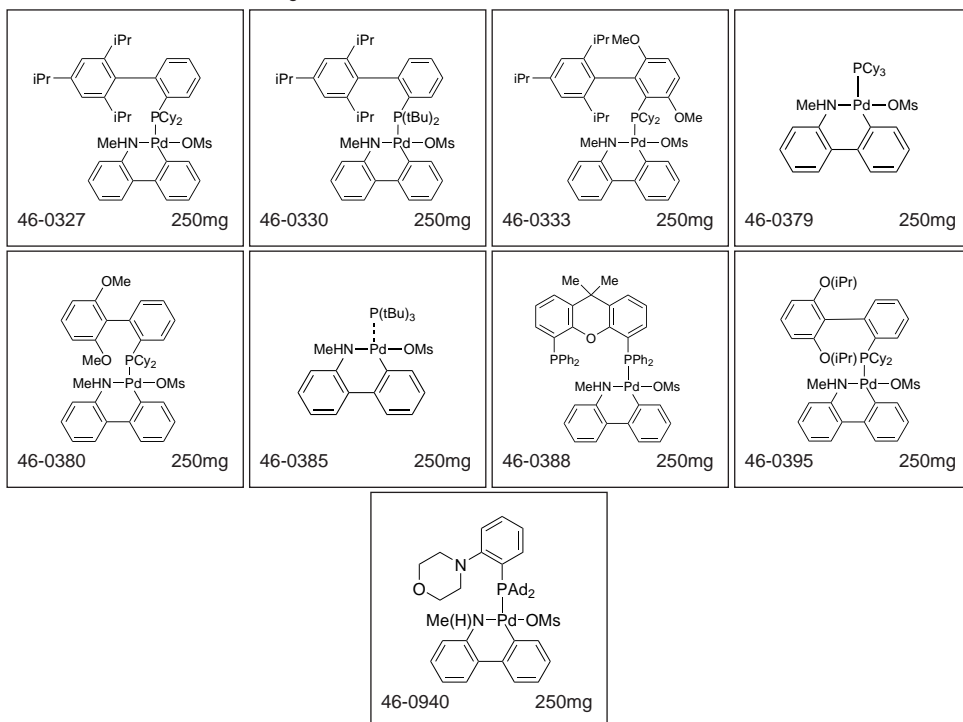

46-0327	Methanesulfonato(2-dicyclohexylphosphino-2',4',6'-tri-i-propyl-1,1'-biphenyl)(2'-methylamino-1,1'-biphenyl-2-yl)palladium(II), min. 98% [XPhos Palladacycle Gen. 4] (1599466-81-5)	250mg	See page 245
46-0330	Methanesulfonato(2-di-t-butylphosphino-2',4',6'-tri-i-propyl-1,1'-biphenyl)(2'-methylamino-1,1'-biphenyl-2-yl)palladium(II) dichloromethane adduct, min. 98% [t-BuXphos Palladacycle Gen. 4] (1599466-89-3)	250mg	See page 243
46-0333	Methanesulfonato(2-dicyclohexylphosphino-3,6-dimethoxy-2',4',6'-tri-i-propyl-1,1'-biphenyl)(2'-methylamino-1,1'-biphenyl-2-yl)palladium(II), min. 98% [BrettPhos Palladacycle Gen. 4] (1599466-83-7)	250mg	See page 244
46-0379	Methanesulfonato(tricyclohexylphosphino)(2'-methylamino-1,1'-biphenyl-2-yl)palladium(II), 98% [PCy ₃ Palladacycle Gen. 4]	250mg	See page 247
46-0380	Methanesulfonato(2-dicyclohexylphosphino-2',6'-dimethoxy-1,1'-biphenyl)(2'-methylamino-1,1'-biphenyl-2-yl)palladium(II) dichloromethane adduct min. 98% [SPhos Palladacycle Gen. 4] (1599466-87-1)	250mg	See page 244
46-0385	Methanesulfonato(tri-t-butylphosphino)(2'-methylamino-1,1'-biphenyl-2-yl)palladium(II), 98% [P(t-Bu) ₃ Palladacycle Gen. 4] (1621274-11-0)	250mg	See page 246
46-0388	Methanesulfonato(9,9-dimethyl-4,5-bis(diphenylphosphino)xanthene)(2'-methylamino-1,1'-biphenyl-2-yl)palladium(II), 98% [Xantphos Palladacycle Gen. 4] (1621274-19-8)	250mg	See page 246
46-0395	Methanesulfonato(2-dicyclohexylphosphino-2',6'-di-i-propoxy-1,1'-biphenyl)(2'-methylamino-1,1'-biphenyl-2-yl)palladium(II), min. 98% [RuPhos Palladacycle Gen. 4] (1599466-85-9)	250mg	See page 245
46-0940	Methanesulfonato(N-[2-(di-1-adamantylphosphino)phenyl]morpholine)(2'-methylamino-1,1'-biphenyl-2-yl)palladium(II) dichloromethane adduct, min. 98% MorDalphos Palladacycle Gen. 4	250mg	See page 241

CATALYST & ORGANOCATALYST KITS - CATHy™ Catalyst Kit**96-7650 CATHy™ Catalyst Kit for Asymmetric Transfer Hydrogenation of Ketones and Imines**

For asymmetric transfer hydrogenation of ketones and imines.
Components also available for individual sale.
Contains the following:

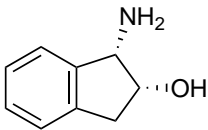
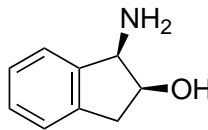
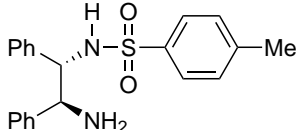
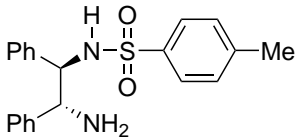
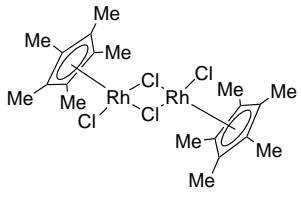
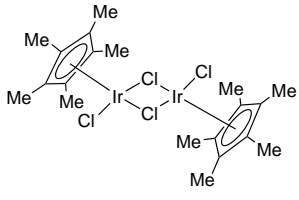
		
07-0200 1g	07-0201 1g	07-2370 500mg
		
07-2371 500mg	45-0195 500mg	77-1060 500mg

Chiral Bidentate Nitrogen Ligands

07-0200	(1S,2R)-(-)-cis-1-Aminoindan-2-ol, 98% (126456-43-7)	1g	See page 178
07-0201	(1R,2S)-(+)-cis-1-Aminoindan-2-ol, 98% (136030-00-7)	1g	See page 178
07-2370	(1S,2S)-(+)-N-(4-toluenesulfonyl)-1,2-diphenylethylenediamine, 98% (S,S)-TsDPEN (167316-27-0)	500mg	See page 210
07-2371	(1R,2R)-(-)-N-(4-toluenesulfonyl)-1,2-diphenylethylenediamine, 98% (R,R)-TsDPEN (144222-34-4)	500mg	See page 210

Rhodium & Iridium Components

45-0195	Dichloro(pentamethylcyclopentadienyl)rhodium(III) dimer, 99% (12354-85-7)	500mg	See page 357
77-1060	Dichloro(pentamethylcyclopentadienyl)iridium(III) dimer, 98% (12354-84-6)	500mg	See page 90

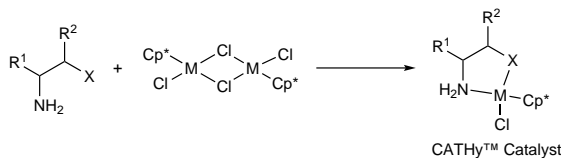
Catalyst Preparation**Technical Notes:**

1. Catalyst for asymmetric ketone reduction in organic and aqueous media
2. Catalyst for asymmetric imine reduction in organic and aqueous media
3. Catalyst for asymmetric oxidative lactonizations of meso-diols
4. Catalyst for asymmetric transfer hydrogenation of quinolines

CATALYST & ORGANOCATALYST KITS - CATHy™ Catalyst Kit

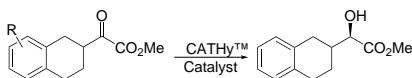
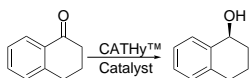

Tech. Note (1)
Ref. (1-7)

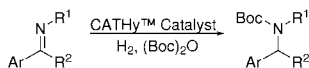
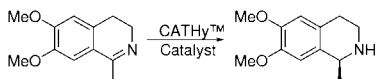
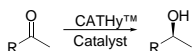

Tech. Note (2)
Ref. (1, 8-10)

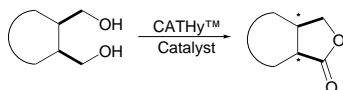
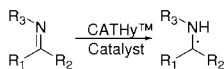
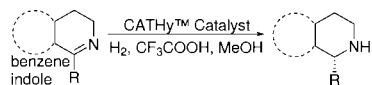

Tech. Note (3)
Ref. (11)



Tech. Note (4)
Ref. (12-13)

References:

1. Blacker A.J., Mellor B.J. WO9842643A1, filed 26/03/97, Avecia Ltd.; Blacker A.J. Conf. Proceedings: The Scale up of Chemical Processes. Jersey 1998 ISBN 0953399400;
2. *Tetrahedron*, **2006**, 62, 1864
3. *Org. Lett.*, **2007**, 9, 2565
4. *Chem. Eur. J.* **2008**, 14, 2209
5. *J. Org. Chem.* **2010**, 75, 2981
6. *J. Org. Chem.* **2015**, 80, 4419
7. *J. Organometal. Chem.* **2016**, 810, 12
8. *Chem. Eur. J.* **2011**, 17, 1109
9. *Org. Lett.* **2015**, 17, 2878
10. *Chem. Commun.*, **2016**, 52, 362
11. *Organometallics* **2002**, 21, 3493
12. *Org. Lett.*, **2008**, 10, 5265
13. *Angew. Chem. Int. Ed.* **2009**, 48, 6524

CATALYST & ORGANOCATALYST KITS - Chiral Quest Catalyst & Ligand Toolbox Kit**96-5900 Chiral Quest Catalyst and Ligand Toolbox Kit for Asymmetric Hydrogenation**

Components also available for individual sale. Contains the following:

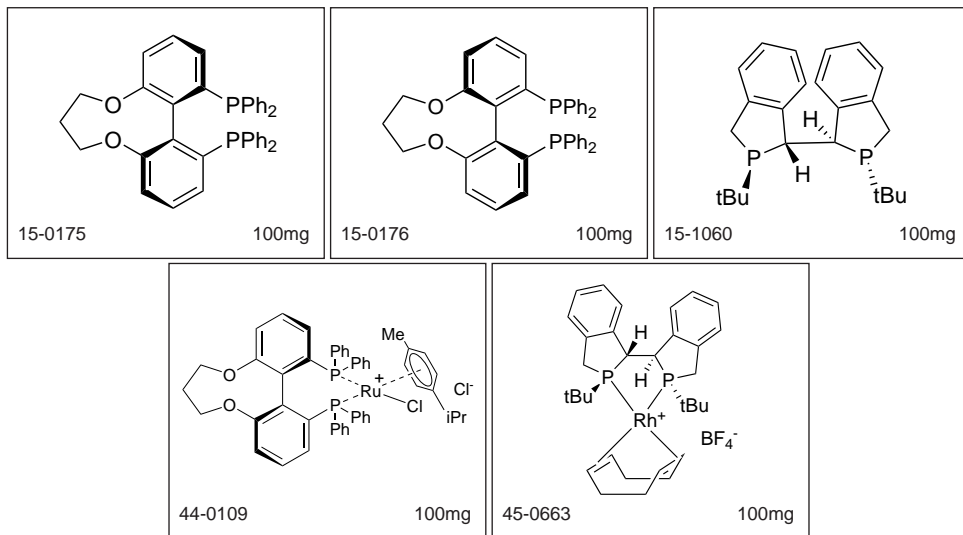

15-0175	R(-)-1,13-Bis(diphenylphosphino)-7,8-dihydro-6H-dibenzo[f,h][1,5]dioxonin, 97% (R)-C ₃ -TUNEPHOS (301847-89-2)	100mg	See page 268
15-0176	(S)-(+)-1,13-Bis(diphenylphosphino)-7,8-dihydro-6H-dibenzo[f,h][1,5]dioxonin, 95% (S)-C ₃ -TUNEPHOS (486429-99-6)	100mg	See page 268
15-1060	(1R,1'R,2S,2'S)-(+)-2,2'-Di-t-butyl-2,3,2',3'-tetrahydro-1,1'-bi-1H-isophosphindole, min. 98% (R,R,S,S)-DUANPHOS (528814-26-8)	100mg	See page 291
44-0109	Chloro((R)-(-)-1,13-bis(diphenylphosphino)-7,8-dihydro-6H-dibenzo[f,h][1,5]dioxonin)(p-cymene)ruthenium(II) chloride (R)-C ₃ -TUNEPHOS-Ru	100mg	See page 374
45-0663	(1R,1'R,2S,2'S)-(+)-2,2'-Di-t-butyl-2,3,2',3'-tetrahydro-1,1'-bi-1H-isophosphindole(1,5-cyclooctadiene)rhodium(I) tetrafluoroborate, min. 98% (R,R,S,S)-DUANPHOS-Rh	100mg	See page 357

CATALYST & ORGANOCATALYST KITS -Cinchona Alkaloid-Derived Organocatalyst Kit**96-1575 Cinchona Alkaloid-Derived Organocatalyst Kit - (enantiopure primary amines) for Iminium-Enamime Activation**

Components also available for individual sale.

Contains the following:

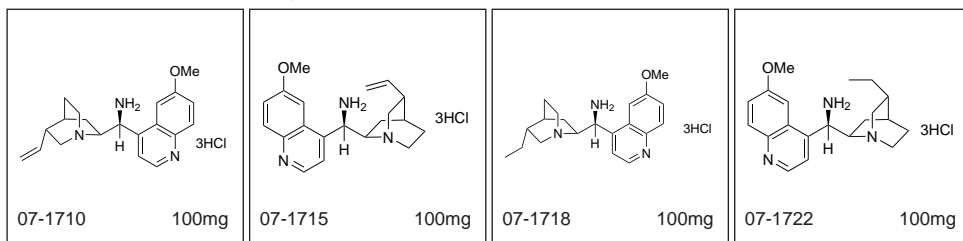

07-1710	(8α, 9S)-6'-Methoxycinchonan-9-amine trihydrochloride, min. 90% (1231763-32-8)	100mg	See page 202
07-1715	(8α, 9R)-6'-Methoxycinchonan-9-amine trihydrochloride, min. 90%	100mg	See page 202
07-1718	(8α, 9S)-10,11-Dihydro-6'-methoxycinchonan-9-amine trihydrochloride, min. 90% (852913-53-2)	100mg	See page 196
07-1722	(9R)-10,11-Dihydro-6'-methoxycinchonan-9-amine trihydrochloride, min. 90% (931098-92-9)	100mg	See page 196

CATALYST & ORGANOCATALYST KITS - (R,R)-Duphos & BPE Rhodium Catalyst Kit**96-4730 (R,R)-Duphos and BPE Rhodium Catalyst Kit for Asymmetric Hydrogenation**

Components also available for individual sale.

Contains the following:

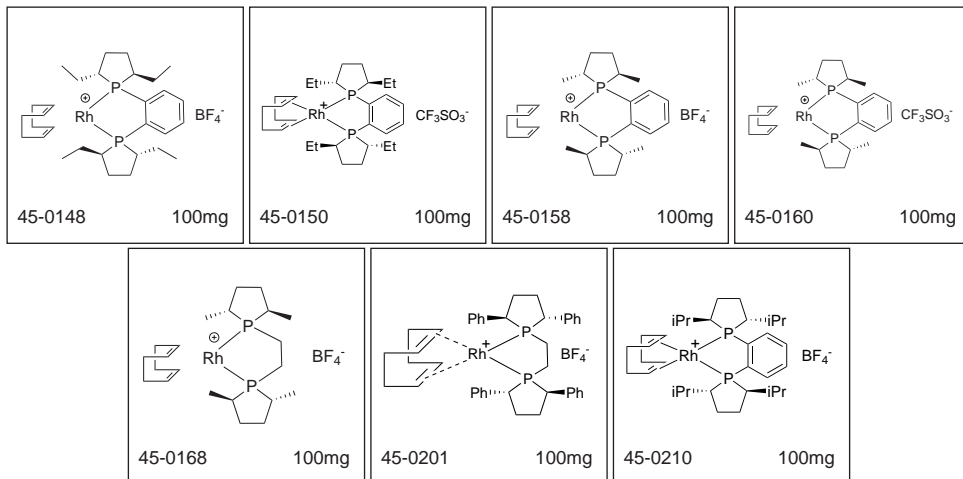

45-0148	(-)-1,2-Bis((2R,5R)-2,5-diethylphospholano)benzene(1,5-cyclooctadiene)rhodium(I) tetrafluoroborate, 98+% (R,R)-Et-DUPHOS-Rh (228121-39-9)	100mg	See page 349
45-0150	(-)-1,2-Bis((2R,5R)-2,5-diethylphospholano)benzene(1,5-cyclooctadiene)rhodium(I) trifluoromethanesulfonate, 98+% (R,R)-Et-DUPHOS-Rh (136705-77-6)	100mg	See page 349
45-0158	(-)-1,2-Bis((2R,5R)-2,5-dimethylphospholano)benzene(1,5-cyclooctadiene)rhodium(I) tetrafluoroborate, 98+% (R,R)-Me-DUPHOS-Rh (210057-23-1)	100mg	See page 350
45-0160	(-)-1,2-Bis((2R,5R)-2,5-dimethylphospholano)benzene(1,5-cyclooctadiene)rhodium(I)trifluoromethanesulfonate, 98+% (R,R)-Me-DUPHOS-Rh (187682-63-9)	100mg	See page 351
45-0168	(+)-1,2-Bis((2R,5R)-2,5-dimethylphospholano)ethane(1,5-cyclooctadiene) rhodium(I) tetrafluoroborate, 98+% (R,R)-Me-BPE-Rh (305818-67-1)	100mg	See page 351
45-0201	(-)-1,2-Bis((2R,5R)-2,5-diphenylphospholano)ethane(1,5-cyclooctadiene)rhodium(I) tetrafluoroborate, min. 98% (R,R)-Ph-BPE-Rh (528565-84-6)	100mg	See page 353
45-0210	(+)-1,2-Bis((2R,5R)-2,5-di-i-propylphospholano)benzene(1,5-cyclooctadiene)rhodium(I) tetrafluoroborate, min. 98% (R,R)-i-Pr-DUPHOS-Rh (569650-64-2)	100mg	See page 354

CATALYST & ORGANOCATALYST KITS - (S,S)-Duphos & BPE Rhodium Catalyst Kit**96-4731 (S,S)-Duphos and BPE Rhodium Catalyst Kit for Asymmetric Hydrogenation**

Components also available for individual sale.

Contains the following:

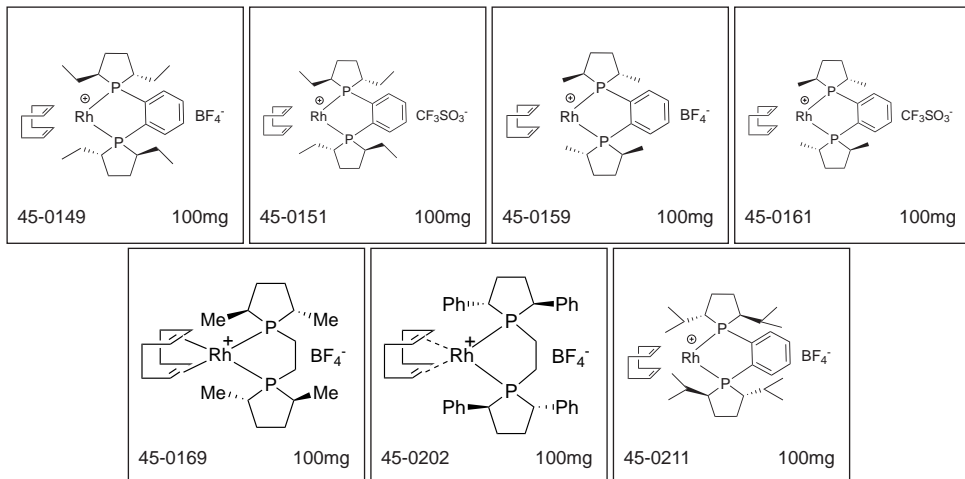

45-0149	(+)-1,2-Bis((2S,5S)-2,5-diethylphospholano)benzene(1,5-cyclooctadiene)rhodium(I) tetrafluoroborate, 98+% (S,S)-Et-DUPHOS-Rh (213343-64-7)	100mg	See page 349
45-0151	(+)-1,2-Bis((2S,5S)-2,5-diethylphospholano)benzene(1,5-cyclooctadiene)rhodium(I) trifluoromethanesulfonate, 98+% (S,S)-Et-DUPHOS-Rh (142184-30-3)	100mg	See page 349
45-0159	(+)-1,2-Bis((2S,5S)-2,5-dimethylphospholano)benzene(1,5-cyclooctadiene)rhodium(I) tetrafluoroborate, 98+% (S,S)-Me-DUPHOS-Rh (205064-10-4)	100mg	See page 350
45-0161	(+)-1,2-Bis((2S,5S)-2,5-dimethylphospholano)benzene(1,5-cyclooctadiene)rhodium(I)trifluoromethanesulfonate, 98+% (S,S)-Me-DUPHOS-Rh (136705-75-4)	100mg	See page 351
45-0169	(-)-1,2-Bis((2S,5S)-2,5-dimethylphospholano)ethane(1,5-cyclooctadiene)rhodium(I) tetrafluoroborate, 98+% (S,S)-Me-BPE-Rh (213343-65-8)	100mg	See page 351
45-0202	(+)-1,2-Bis((2S,5S)-2,5-diphenylphospholano)ethane(1,5-cyclooctadiene)rhodium(I) tetrafluoroborate, min. 98% (S,S)-Ph-BPE-Rh (849950-53-4)	100mg	See page 353
45-0211	(-)-1,2-Bis((2S,5S)-2,5-di-i-propylphospholano)benzene(1,5-cyclooctadiene)rhodium(I) tetrafluoroborate, min. 98% (S,S)-i-Pr-DUPHOS-Rh	100mg	See page 354

CATALYST & ORGANOCATALYST KITS - Enantiotech BIMAH Ru BINAP Catalyst Kit**96-3705 Enantiotech BIMAH Ru BINAP Catalyst Kit for Asymmetric Hydrogenation**

Sold under license from Enantiotech for research purposes.

PCT/CN2008/073648, CN 200810038929.

Components also available for individual sale.

Contains the following:

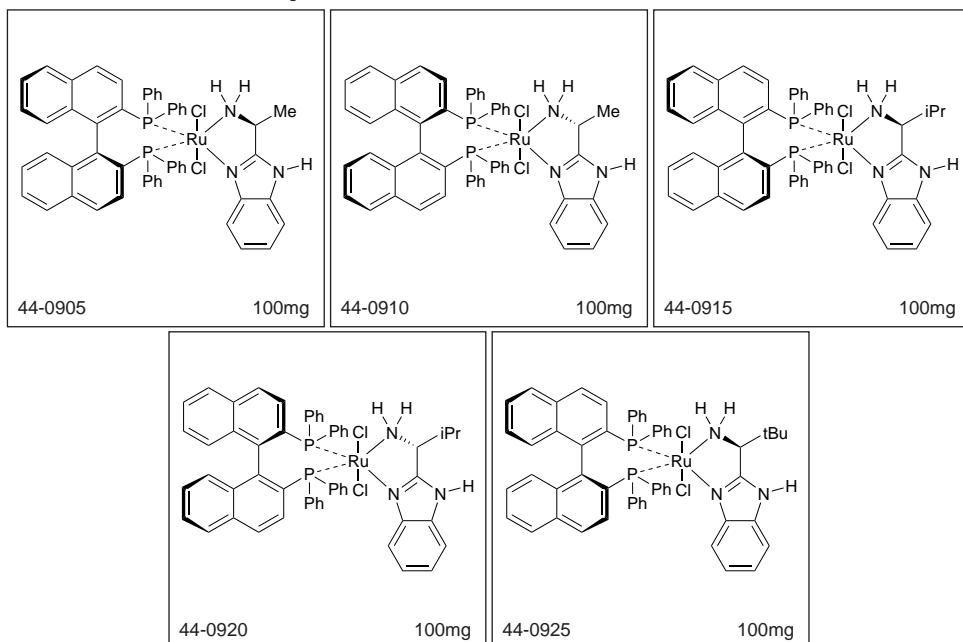

44-0905	Dichloro[(S)-(-)-2,2'-bis(diphenylphosphino)-1,1'-binaphthyl][(S)-(-)-2-(α -methylmethanamine)-1H-benzimidazole]ruthenium(II), min. 95% (1443051-87-3)	100mg	See page 385
44-0910	Dichloro[(R)-(+)-2,2'-bis(diphenylphosphino)-1,1'-binaphthyl][(S)-(+)-2-(α -methylmethanamine)-1H-benzimidazole]ruthenium(II), min. 95%	100mg	See page 385
44-0915	Dichloro[(S)-(-)-2,2'-bis(diphenylphosphino)-1,1'-binaphthyl][(S)-(-)-2-(α -(i-propyl)methanamine)-1H-benzimidazole]ruthenium(II), min. 95%	100mg	See page 386
44-0920	Dichloro[(R)-(+)-2,2'-bis(diphenylphosphino)-1,1'-binaphthyl][(R)-(+)-2-(α -(i-propyl)methanamine)-1H-benzimidazole]ruthenium(II), min. 95%	100mg	See page 385
44-0925	Dichloro[(S)-(-)-2,2'-bis(diphenylphosphino)-1,1'-binaphthyl][(S)-(-)-2-(α -(t-butyl)methanamine)-1H-benzimidazole]ruthenium(II), min. 95%	100mg	See page 384

CATALYST & ORGANOCATALYST KITS - EnantioTech BIMA Ru DIOP Catalyst Kit**96-3715 EnantioTech BIMA Ru DIOP Catalyst Kit for Asymmetric Hydrogenation**

Sold under license from EnantioTech for research purposes only.

PCT/CN2008/073648, CN 200810038929.

Components also available for individual sale.

Contains the following:

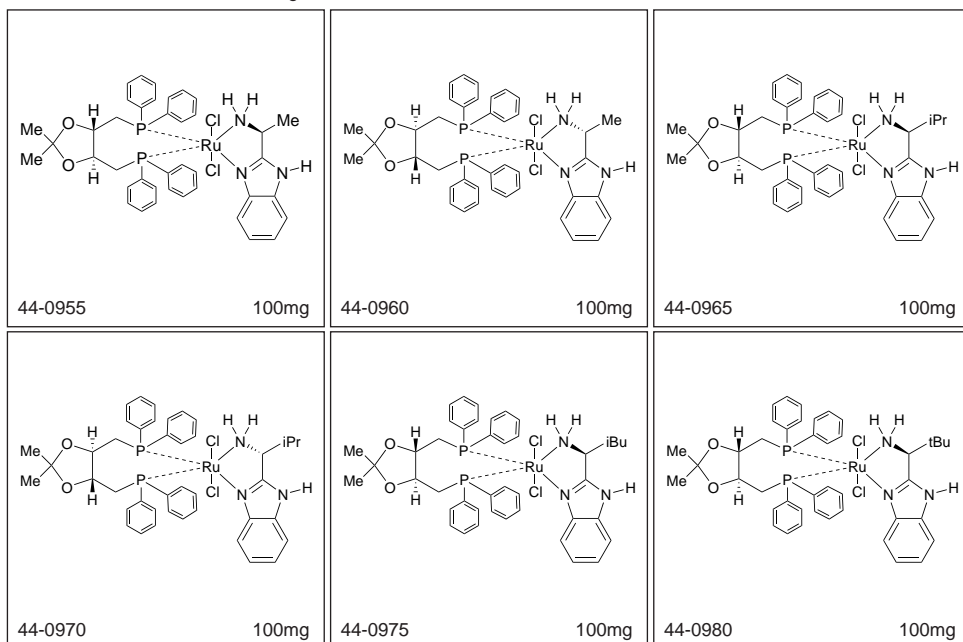

44-0955	Dichloro[(4S,5S)-(+)-4,5-bis(diphenylphosphinomethyl)-2,2-dimethyl-1,3-dioxolane][(S)-(-)-2-(alpha-methylmethanamine)-1H-benzimidazole] ruthenium(II), min. 98% (1280730-21-3)	100mg	See page 387
44-0960	Dichloro[(4R,5R)-(-)-4,5-bis(diphenylphosphinomethyl)-2,2-dimethyl-1,3-dioxolane][(R)-(+)-2-(alpha-methylmethanamine)-1H-benzimidazole] ruthenium(II), min. 95% (1280732-29-7)	100mg	See page 387
44-0965	Dichloro[(4S,5S)-(+)-4,5-bis(diphenylphosphinomethyl)-2,2-dimethyl-1,3-dioxolane][(S)-(-)-2-(i-propyl)methanamine)-1H-benzimidazole] ruthenium(II), min. 95% (1443051-97-5)	100mg	See page 387
44-0970	Dichloro[(4R,5R)-(-)-4,5-bis(diphenylphosphinomethyl)-2,2-dimethyl-1,3-dioxolane][(R)-(+)-2-(i-propyl)methanamine)-1H-benzimidazole] ruthenium(II), min. 95%	100mg	See page 387
44-0975	Dichloro[(4S,5S)-(+)-4,5-bis(diphenylphosphinomethyl)-2,2-dimethyl-1,3-dioxolane][(S)-(-)-2-(i-butyl)methanamine)-1H-benzimidazole] ruthenium(II), min. 95% (1574321-76-8)	100mg	See page 386
44-0980	Dichloro[(4S,5S)-(+)-4,5-bis(diphenylphosphinomethyl)-2,2-dimethyl-1,3-dioxolane][(S)-(-)-2-(t-butyl)methanamine)-1H-benzimidazole] ruthenium(II), min. 97% (1443051-98-6)	100mg	See page 386

CATALYST & ORGANOCATALYST KITS - EnantioTech BIMA Ru Tol-BINAP Catalyst Kit**96-3710 EnantioTech BIMA Ru Tol-BINAP Catalyst Kit for Asymmetric Hydrogenation**

Sold under license from EnantioTech for research purposes only.

PCT/CN2008/073648, CN 200810038929.

Components also available for individual sale.

Contains the following:

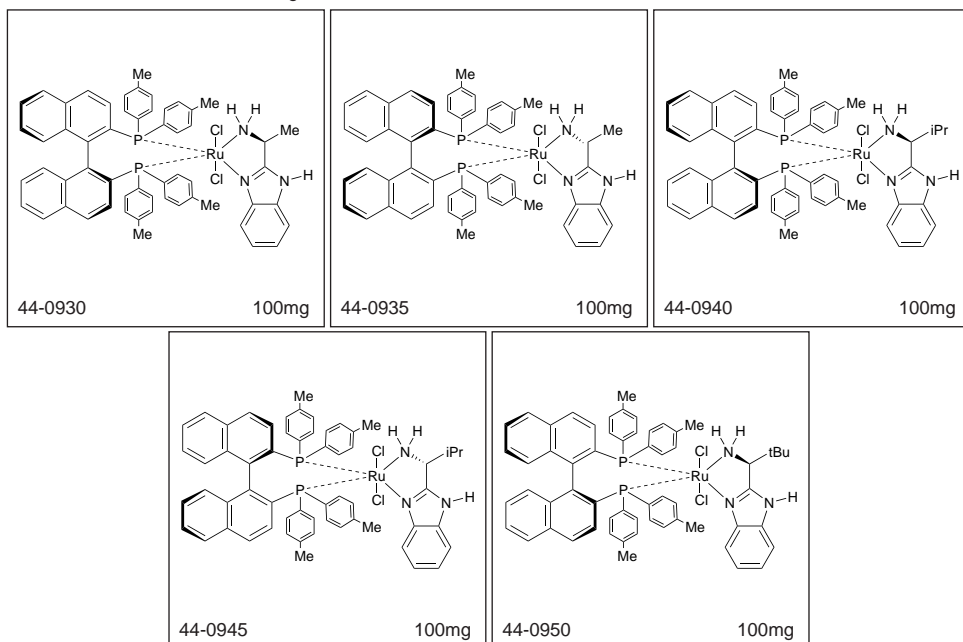

44-0930	Dichloro[(S)-(-)-2,2'-bis(di-p-tolylphosphino)-1,1'-binaphthyl][(S)-(-)-2-(α -methylmethanamine)-1H-benzimidazole]ruthenium(II), min. 97%	100mg	See page 388
44-0935	Dichloro[(R)-(+)-2,2'-bis(di-p-tolylphosphino)-1,1'-binaphthyl][(R)-(+)-2-(α -methylmethanamine)-1H-benzimidazole]ruthenium(II), min. 95%	100mg	See page 388
44-0940	Dichloro[(S)-(-)-2,2'-bis(di-p-tolylphosphino)-1,1'-binaphthyl][(S)-(-)-2-(α -(i-propyl) methanamine)-1H-benzimidazole]ruthenium(II), min. 95%	100mg	See page 389
44-0945	Dichloro[(R)-(+)-2,2'-bis(di-p-tolylphosphino)-1,1'-binaphthyl][(R)-(+)-2-(α -(i-propyl) methanamine)-1H-benzimidazole]ruthenium(II), min. 95%	100mg	See page 388
44-0950	Dichloro[(S)-(-)-2,2'-bis(di-p-tolylphosphino)-1,1'-binaphthyl][(S)-(-)-2-(α -(t-butyl) methanamine)-1H-benzimidazole]ruthenium(II), min. 97%	100mg	See page 388

CATALYST & ORGANOCATALYST KITS - Evonik Heterogeneous Catalyst Kit**96-6670****Evonik Heterogeneous Catalyst Kit**Sold in collaboration with Evonik for research purposes only.
Components also available for individual sale. Contains the following:

44-4060	Ruthenium, 5% on activated carbon, (50-70% wetted powder) Evonik Noblyst® P3060 (7440-18-8)	10g	See page 362
45-1863	Rhodium, 5% on activated carbon (50-70% wetted powder) Evonik Noblyst® P3053 (7440-16-6)	10g	See page 348
46-1703	Palladium, 5% on activated carbon (50-70% wetted powder) Evonik Noblyst® P1086 (7440-05-3)	10g	See page 223
46-1706	Palladium, 10% on activated carbon, Pearlman (50-70% wetted powder) Evonik Noblyst® P1070 (7440-05-3)	10g	See page 222
46-1740	Palladium, 5% on activated carbon (50-70% wetted powder) Evonik Noblyst® P1090 (7440-05-3)	10g	See page 223
46-1743	Palladium, 5% on activated carbon (50-70% wetted powder) Evonik Noblyst® P1093 (7440-05-3)	10g	See page 223
46-1747	Palladium, 5% on activated carbon (50-70% wetted powder) Evonik Noblyst® P1092 (7440-05-3)	10g	See page 223
46-1750	Palladium, 5% on activated carbon (50-70% wetted powder) Evonik Noblyst® P1109 (7440-05-3)	10g	See page 223
78-1530	Platinum, 5% on activated carbon (50-70% wetted powder) Evonik Noblyst® P2058 (7440-06-4)	10g	See page 333
78-1534	Platinum, 5% on activated carbon (50-70% wetted powder) Evonik Noblyst® P2060 (7440-06-4)	10g	See page 333
78-1536	Platinum 1% and vanadium 2%, on activated carbon (50-70% wetted powder) Evonik Noblyst® P8078 (7440-06-4)	10g	See page 336
78-1540	Platinum, 3% on activated carbon, sulfided (50-70% wetted powder) Evonik Noblyst® P2065 (7440-06-4)	10g	See page 333

CATALYST & ORGANOCATALYST KITS - Evonik Heterogeneous Catalyst Kit for Selective Hydrogenation**96-6674****Evonik Heterogeneous Catalyst Kit for Selective Hydrogenation**Sold in collaboration with Evonik for research purposes only.
Components also available for individual sale. Contains the following:

44-4060	Ruthenium, 5% on activated carbon, (50-70% wetted powder) Evonik Noblyst® P3060 (7440-18-8)	10g	See page 362
45-1863	Rhodium, 5% on activated carbon (50-70% wetted powder) Evonik Noblyst® P3053 (7440-16-6)	10g	See page 348
78-1530	Platinum, 5% on activated carbon (50-70% wetted powder) Evonik Noblyst® P2058 (7440-06-4)	10g	See page 333
78-1534	Platinum, 5% on activated carbon (50-70% wetted powder) Evonik Noblyst® P2060 (7440-06-4)	10g	See page 333
78-1536	Platinum 1% and vanadium 2%, on activated carbon (50-70% wetted powder) Evonik Noblyst® P8078 (7440-06-4)	10g	See page 336
78-1540	Platinum, 3% on activated carbon, sulfided (50-70% wetted powder) Evonik Noblyst® P2065 (7440-06-4)	10g	See page 333

CATALYST & ORGANOCATALYST KITS - Evonik Heterogeneous Palladium Catalyst Kit**96-6672****Evonik Heterogeneous Palladium Catalyst Kit**Sold in collaboration with Evonik for research purposes only.
Components also available for individual sale. Contains the following:

46-1703	Palladium, 5% on activated carbon (50-70% wetted powder) Evonik Noblyst® P1086 (7440-05-3)	10g	See page 223
46-1706	Palladium, 10% on activated carbon, Pearlman (50-70% wetted powder) Evonik Noblyst® P1070 (7440-05-3)	10g	See page 222
46-1740	Palladium, 5% on activated carbon (50-70% wetted powder) Evonik Noblyst® P1090 (7440-05-3)	10g	See page 223
46-1743	Palladium, 5% on activated carbon (50-70% wetted powder) Evonik Noblyst® P1093 (7440-05-3)	10g	See page 223
46-1747	Palladium, 5% on activated carbon (50-70% wetted powder) Evonik Noblyst® P1092 (7440-05-3)	10g	See page 223
46-1750	Palladium, 5% on activated carbon (50-70% wetted powder) Evonik Noblyst® P1109 (7440-05-3)	10g	See page 223

CATALYST & ORGANOCATALYST KITS - Evonik Heterogeneous Catalyst Kits Table

96-6670 - Heterogeneous Catalyst Kit												
Stream Item #	96-6672 - Palladium Catalyst Kit						96-6674 - Selective Hydrogenation Kit					
	46-1706	46-1703	46-1740	46-1747	46-1743	46-1750	78-1530	78-1534	78-1540	45-1863	44-4060	78-1536
Evonik Item #	E 101 NEW	E 101 RW	E 105 NW	E 105 NNW	E 105 OW	E 107 MA	F 1015 REV	F 105 NW	F 1082 QHA/W	G 106 NW	H 108 PW	CF 1082 B/W
Nobylis® nomenclature Application/ Catalyst	Nobylis® P 1070 10% Pd	Nobylis® P 1086 5% Pd	Nobylis® P 1090 5% Pd	Nobylis® P 1092 5% Pd	Nobylis® P 1093 5% Pd	Nobylis® P 1109 5% Pd	Nobylis® P 2058 5% Pt	Nobylis® P 2080 5% Pt	Nobylis® P 2065 3% Pt	Nobylis® P 3053 5% Rh	Nobylis® P 3080 5% Ru	Nobylis® P 3078 1% Pt
Hydrogenation of C=C Double Bonds	●	●	○	○	●	○	○	○	○	○	○	○
Hydrogenation of CN Bonds	○	○	○	○	○	○	○	○	○	○	○	○
Reduction of the C=O Group	○	○	○	○	○	○	○	○	○	○	○	○
Hydrogenation of Nitro Groups	●	●	●	●	○	○	●	○	○	○	○	●
Hydrogenolysis Reactions (De protections, Dehalogenations, etc.)	○	○	●	●	○	○	○	○	○	○	○	○
Reductive Alkylation and Amination	○	○	○	○	●	○	○	○	●	○	○	○
Hydrogenation of (Hetero)Aromatic Rings	○	○	○	○	○	○	○	○	○	○	○	○
Oxidations (Alcohols and Sugars)	○	○	○	○	○	○	○	○	○	○	○	○
CC Coupling Reactions	○	○	○	○	○	○	○	○	○	○	○	○
											○ recommended	
											● preferred	

Note: Please refer to the different reaction classes in the Evonik manual for more detailed information regarding selectivity, activity and reaction conditions. This sample kit is designed as an entry point to find a suitable catalyst. Please contact one of our technical specialists for further recommendations. Most often the catalyst performance can be improved significantly by tailoring the catalyst to your requirements.

The recommendations given above are believed to be accurate at the time of publication but EVONIK makes no warranty with respect thereto, including but not limited to any results to be obtained or the infringement of any proprietary right.

CATALYST & ORGANOCATALYST KITS - Iridicycle Catalyst Kit**96-3745 Iridicycle Catalyst Kit**

Sold in collaboration with Yorkshire Process Technology for research purposes only. Developed by Prof. J. Xiao, Liverpool University.
 Patents GB 1206572.8 and GB 1206573.6
 Components also available for individual sale.
 Contains the following:

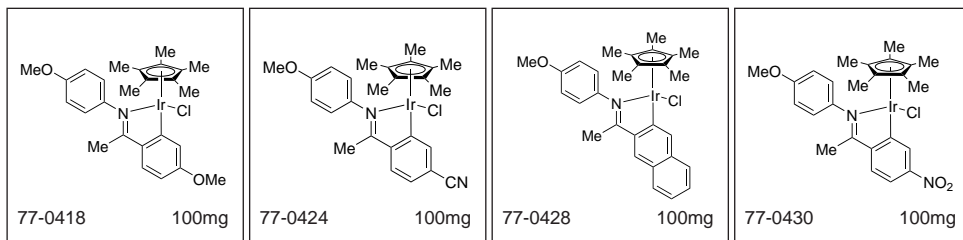

77-0418	Chloro(pentamethylcyclopentadienyl){5-methoxy-2-[(4-methoxyphenyl)imino-kN]ethyl}phenyl-kC}iridium(III), 99% Iridicycle-MeO (1258964-48-5)	100mg	See page 88
77-0424	Chloro(pentamethylcyclopentadienyl){5-cyano-2-[(4-methoxyphenyl)imino-kN]ethyl}phenyl-kC}iridium(III), 99% Iridicycle-CN (1258964-46-3)	100mg	See page 87
77-0428	Chloro(pentamethylcyclopentadienyl){2-[(4-methoxyphenyl)imino-kN]ethyl}naphthyl-kC}iridium(III), 99% Iridicycle-Naphth (1469467-94-4)	100mg	See page 88
77-0430	Chloro(pentamethylcyclopentadienyl){5-nitro-2-[(4-methoxyphenyl)imino-kN]ethyl}phenyl-kC}iridium(III), 99% Iridicycle-NO2 (1439402-25-1)	100mg	See page 88

CATALYST & ORGANOCATALYST KITS - Kit of CatKits - Single-Use Vial**96-3790 Kit of CatKits - Single-Use Vials for Low Catalyst Loading Experiments**

Components also available for individual sale.
 Contains the following:

46-2030	Palladium(II) acetate/1,1'-bis(di-t-butylphosphino)ferrocene/potassium phosphate admixture [CatKit single-use vials - 2.02 wt% Pd(OAc) ₂]	5 x 1vial	See page 247
46-2033	Palladium(II) acetate/2-dicyclohexylphosphino-2,6-dimethoxy-1,1'-bi-phenyl (SPhos)/potassium phosphate admixture [CatKit single-use vials - 1.96 wt% Pd(OAc) ₂]	5 x 1vial	See page 247
46-2038	trans-Dichlorobis(triphenylphosphine)palladium(II)/potassium phosphate admixture [CatKit single-use vials - 6.32 wt% Pd complex] (13965-03-2)	5 x 1vial	See page 239
46-2040	trans-Dichlorobis(tricyclohexylphosphine)palladium(II)/potassium phosphate admixture [CatKit single-use vials - 6.62 wt% Pd complex] (29934-17-6)	5 x 1vial	See page 238

Components	46-2040	46-2038	46-2030	46-2033
Metal Precursor			Pd(OAc) ₂	Pd(OAc) ₂
Ligand	---	---		
Base	K ₃ PO ₄	K ₃ PO ₄	K ₃ PO ₄	K ₃ PO ₄

This Kit contains 4 different types of Single-Use Vials. Each type has 5 x 1 vials.

CATALYST & ORGANOCATALYST KITS - Maruoka Chiral Phase-Transfer Phosphonium Organocatalyst Kit

96-3750

Maruoka Chiral Phase-Transfer Phosphonium Organocatalyst Kit

Components also available for individual sale.

Contains the following:

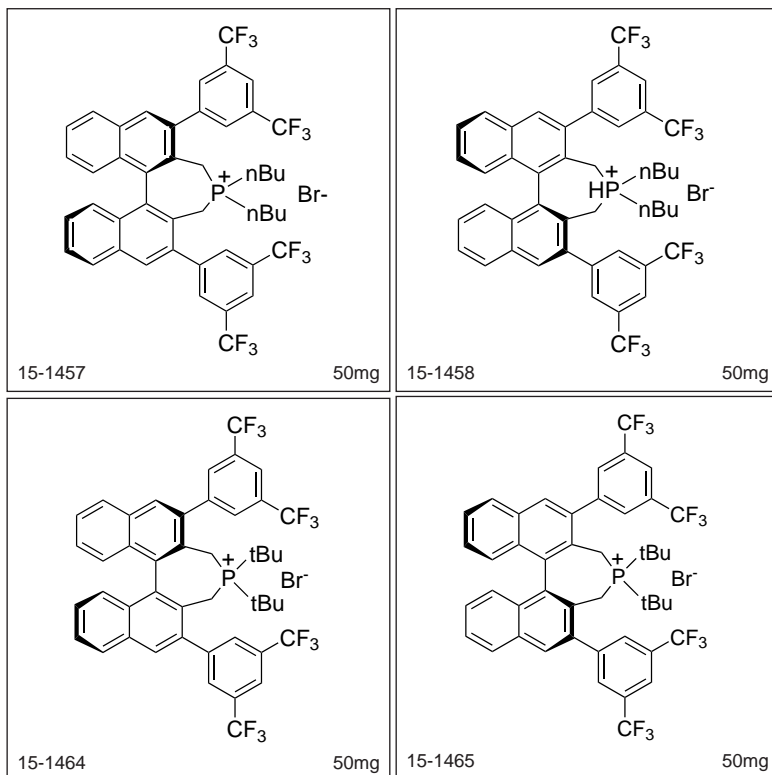

15-1457	(11bR)-(+)-4,4-Dibutyl-2,6-bis[3,5-bis(trifluoromethyl)phenyl]-4,5-dihydro-3H-dinaphtho[2,1-c:1',2'-e]phosphepinium bromide, 99% R-MARUOKA CAT P-NB	50mg	See page 286
15-1458	(11bS)-(-)-4,4-Dibutyl-2,6-bis[3,5-bis(trifluoromethyl)phenyl]-4,5-dihydro-3H-dinaphtho[2,1-c:1',2'-e]phosphepinium bromide, 99% S-Maruko CAT P-NB (1110711-01-7)	50mg	See page 286
15-1464	(11bR)-(+)-4,4-Di-t-butyl-2,6-bis[3,5-bis(trifluoromethyl)phenyl]-4,5-dihydro-3H-dinaphtho[2,1-c:1',2'-e]phosphepinium bromide, 99% R-MARUOKA CAT P-TB	50mg	See page 286
15-1465	(11bS)-(-)-4,4-Di-t-butyl-2,6-bis[3,5-bis(trifluoromethyl)phenyl]-4,5-dihydro-3H-dinaphtho[2,1-c:1',2'-e]phosphepinium bromide, 99% S-MARUOKA CAT P-TB	50mg	See page 286

CATALYST & ORGANOCATALYST KITS - Palladium Kit

96-4650

Palladium Kit

For a variety of catalytic organic transformations.

Components also available for individual sale.

Contains the following:

46-0100	Allylpalladium chloride dimer, min. 98% (12012-95-2)	500mg	See page 226
46-0400	Dichlorobis(benzonitrile)palladium(II), 99% (14220-64-5)	1g	See page 236
46-1780	Palladium(II) acetate, min. 98% (99.9+%Pd) (3375-31-3)	1g	See page 247
46-1850	Palladium(II) chloride (99.9%-Pd) (7647-10-1)	1g	See page 248
46-2150	Tetrakis(triphenylphosphine)palladium(0), 99% (99.9+%Pd) (14221-01-3)	5g	See page 248
46-3000	Tris(dibenzylideneacetone)dipalladium(0) (51364-51-3)	5g	See page 249
46-3010	Tris(dibenzylideneacetone)dipalladium(0) chloroform adduct (52522-40-4)	500mg	See page 249

CATALYST & ORGANOCATALYST KITS - PhosphonicS Metal Oxidation Catalyst Kit

96-6770

PhosphonicS Metal Oxidation Catalyst Kit

Sold in collaboration with PhosphonicS Ltd. for research purposes only.

Components also available for individual sale.

Contains the following:

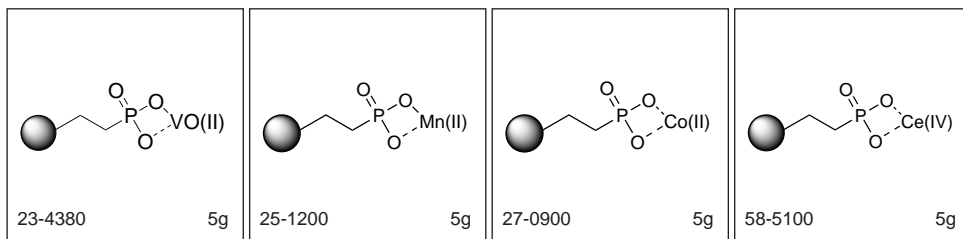

23-4380	Vanadyl(II) ethyl/butyl phosphonate Silica (PhosphonicS POVO)	5g	See page 446
25-1200	Manganese(II) ethyl/butyl phosphonate Silica (PhosphonicS POMn)	5g	See page 126
27-0900	Cobalt(II) ethyl/butyl phosphonate Silica (PhosphonicS POCe)	5g	See page 49
58-5100	Cerium(IV) ethyl/butyl phosphonate Silica (PhosphonicS POCE)	5g	See page 41

Reactions such as allylic and benzylic oxidations, alcohol oxidations and epoxidations are key chemical transformations in organic synthesis. In general these reactions are conducted by the use of stoichiometric, or even higher concentrations, of inorganic oxidants. Typical oxidizing agents include potassium permanganate, manganese dioxide, chromium trioxide, potassium chromate, potassium dichromate and peracids. These hazardous reagents produce large volumes of toxic wastes that are becoming increasingly costly to treat and dispose. In addition, difficulties are often encountered in the work up of reactions and purification of the products. There is a need for new heterogeneous oxidation catalysts that are not only effective, but exhibit ease of recovery and recyclability. PhosphonicS has developed a number of novel heterogeneous oxidation catalysts for a wide range of applications in the pharmaceutical, fine chemicals and petrochemical industries. Reactions include allylic and benzylic oxidations, epoxidations and the selective oxidations of alcohols to ketones and sulfides to sulfoxides.

CATALYST & ORGANOCATALYST KITS - SpinPHOX-Ir Catalyst Kit**96-7710 SpinPHOX-Ir Catalyst Kit for enantioselective hydrogenation**

Sold in collaboration with SIOC for research purposes only.

Patents CN200910051314.3, CN 101555259.

Components also available for individual sale.

Contains the following:

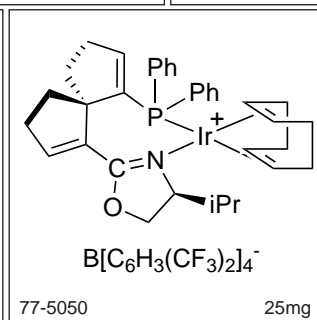
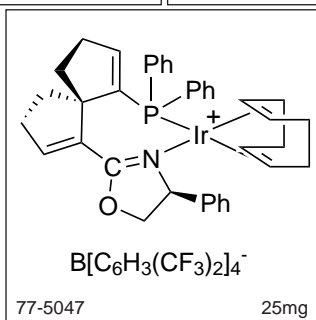
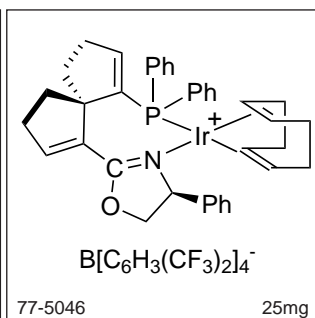
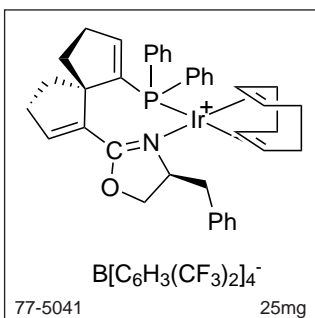
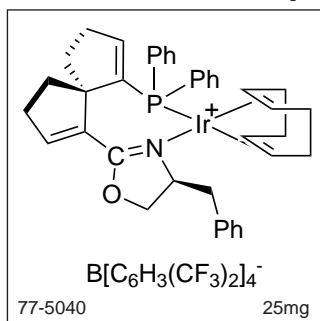

77-5040	1,5-Cyclooctadiene((4S)-(+)-2-[(5S)-6-(diphenylphosphino)spiro[4.4]nona-1.6-dien-1-yl]-4,5-dihydro-4-benzoxazole)iridium(I) tetrakis[3,5-bis(trifluoromethyl)phenyl]borate, 97% (S,S)-(COD) Ir[Bn-SpinPHOX] (1194050-19-5)	25mg	See page 89
77-5041	1,5-Cyclooctadiene((4S)-(-)-2-[(5R)-6-(diphenylphosphino)spiro[4.4]nona-1.6-dien-1-yl]-4,5-dihydro-4-benzoxazole)iridium(I) tetrakis[3,5-bis(trifluoromethyl)phenyl]borate, 97% (R,S)-(COD) Ir[Bn-SpinPHOX] (1195511-56-8)	25mg	See page 89
77-5046	1,5-Cyclooctadiene((4S)-(+)-2-[(5S)-6-(diphenylphosphino)spiro[4.4]nona-1.6-dien-1-yl]-4,5-dihydro-4-phenyloxazole)iridium(I) tetrakis[3,5-bis(trifluoromethyl)phenyl]borate, 97% (S,S)-(COD) Ir[Ph-SpinPHOX] (1194050-21-9)	25mg	See page 89
77-5047	1,5-Cyclooctadiene((4S)-(-)-2-[(5R)-6-(diphenylphosphino)spiro[4.4]nona-1.6-dien-1-yl]-4,5-dihydro-4-phenyloxazole)iridium(I) tetrakis[3,5-bis(trifluoromethyl)phenyl]borate, 97% (R,S)-(COD) Ir[Ph-SpinPHOX] (1195511-59-1)	25mg	See page 89
77-5050	1,5-Cyclooctadiene((4S)-(+)-2-[(5S)-6-(diphenylphosphino)spiro[4.4]nona-1.6-dien-1-yl]-4,5-dihydro-4-(i-propyl)oxazole)iridium(I) tetrakis[3,5-bis(trifluoromethyl)phenyl]borate, 97% (S,S)-(COD) Ir[iPr-SpinPHOX] (1194050-23-1)	25mg	See page 89

CATALYST & ORGANOCATALYST KITS - Takasago ATH Catalyst Kit**96-6955 Takasago ATH (Asymmetric Transfer Hydrogenation) Catalyst Kit**

Manufactured under license of Takasago patent US7129367B2.

Components also available for individual sale.

Contains the following:

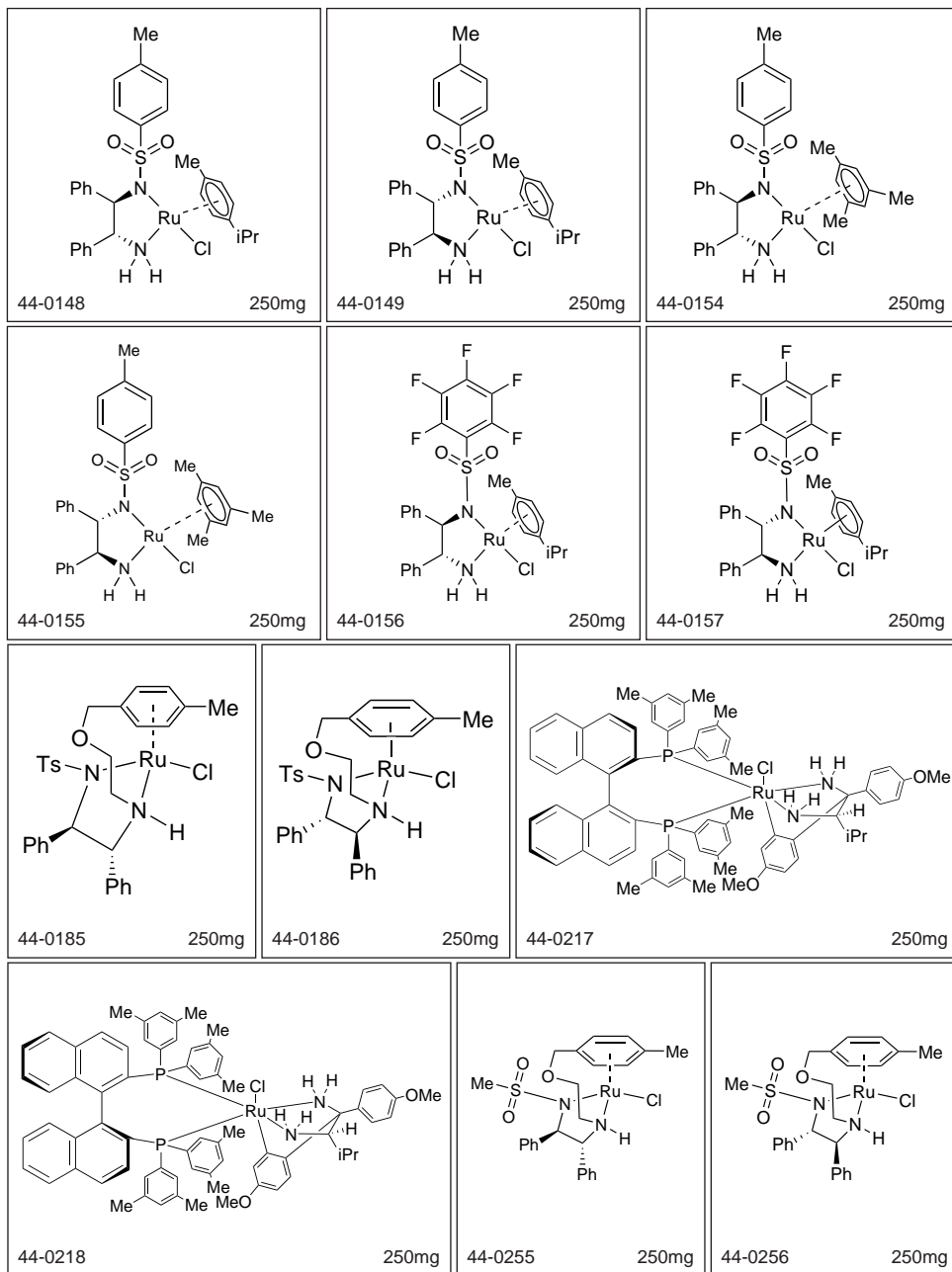

CATALYST & ORGANOCATALYST KITS - Takasago ATH Catalyst Kit

44-0148	Chloro{[(1R,2R)-(-)-2-amino-1,2-diphenylethyl](4-toluenesulfonyl)amido}(p-cymene)ruthenium(II), min. 95% RuCl[(R,R)-Tsdpen](p-cymene) (192139-92-7)	250mg	See page 370
44-0149	Chloro{[(1S,2S)-(+)-2-amino-1,2-diphenylethyl](4-toluenesulfonyl)amido}(p-cymene)ruthenium(II), min. 90% RuCl[(S,S)-Tsdpen](p-cymene) (192139-90-5)	250mg	See page 370
44-0154	Chloro{[(1R,2R)-(-)-2-amino-1,2-diphenylethyl](4-toluenesulfonyl)amido}(mesitylene)ruthenium(II), min. 90% RuCl[(R,R)-Tsdpen(mesitylene) (174813-82-2)	250mg	See page 371
44-0155	Chloro{[(1S,2S)-(+)-2-amino-1,2-diphenylethyl](4-toluenesulfonyl)amido}(mesitylene)ruthenium(II), min. 90% RuCl[(S,S)-Tsdpen](mesitylene) (174813-81-1)	250mg	See page 371
44-0156	Chloro{[(1R,2R)-(-)-2-amino-1,2-diphenylethyl](pentafluorophenylsulfonyl)amido}(p-cymene)ruthenium(II), min. 90% RuCl[(R,R)-Fsdpen](p-cymene) (1026995-71-0)	250mg	See page 370
44-0157	Chloro{[(1S,2S)-(+)-2-amino-1,2-diphenylethyl](pentafluorophenylsulfonyl)amido}(p-cymene)ruthenium(II), min. 90% RuCl[(S,S)-Fsdpen](p-cymene) (1026995-72-1)	250mg	See page 370
44-0185	Chloro{N-[(1R,2R)-1,2-diphenyl-2-(2-(4-methylbenzyloxy)ethylamino)ethyl]-4-methylbenzene sulfonamide(chloro)ruthenium(II) (R,R)-Ts-DENEB™ (1333981-84-2)	250mg	See page 378
44-0186	N-[(1S,2S)-1,2-Diphenyl-2-(2-(4-methylbenzyloxy)ethylamino)ethyl]-4-methylbenzene sulfonamide(chloro)ruthenium(II) (S,S)-Ts-DENEB™ (1384974-37-1)	250mg	See page 396
44-0217	Chloro{(R)-(+)-2,2'-bis[di(3,5-xylyl)phosphino]-1,1'-binaphthyl} [(2R)-(-)-1-(4-methoxyphenyl)-1'-(4-methoxyphenyl)-kC]-3-methyl-1,2-butanediamine)ruthenium(II) (R)-RUCY™-XylBINAP (1384974-38-2)	250mg	See page 376
44-0218	Chloro{(S)-(-)-2,2'-bis[di(3,5-xylyl) phosphino]-1,1'-binaphthyl} [(2S)-(+)-1-(4-methoxyphenyl)-1'-(4-methoxyphenyl)-kC]-3-methyl-1,2-butanediamine)ruthenium(II) (S)-RUCY™-XylBINAP (1312713-89-5)	250mg	See page 376
44-0255	Chloro{N-[(1R,2R)-2-[(S)-[2-[[1,2,3,4,5,6-η]-4-methylphenyl]methoxy]ethyl]amino]-1,2-diphenylethylmethanesulfonamidato)ruthenium(II) Ru-(R,R)-Ms-DENEB (1333981-86-4)	250mg	See page 379
44-0256	Chloro{N-[(1S,2S)-2-[(R)-[2-[[1,2,3,4,5,6-η]-4-methylphenyl]methoxy]ethyl]amino]-1,2-diphenylethylmethanesulfonamidato)ruthenium(II) Ru-(S,S)-Ms-DENEB (1361318-83-3)	250mg	See page 379

CATALYST & ORGANOCATALYST KITS - Takasago BINAP Ru Acetate Catalyst Kit

96-6953

Takasago BINAP Ru Acetate Catalyst Kit

Manufactured under license of Takasago patent.

Components also available for individual sale.

Contains the following:

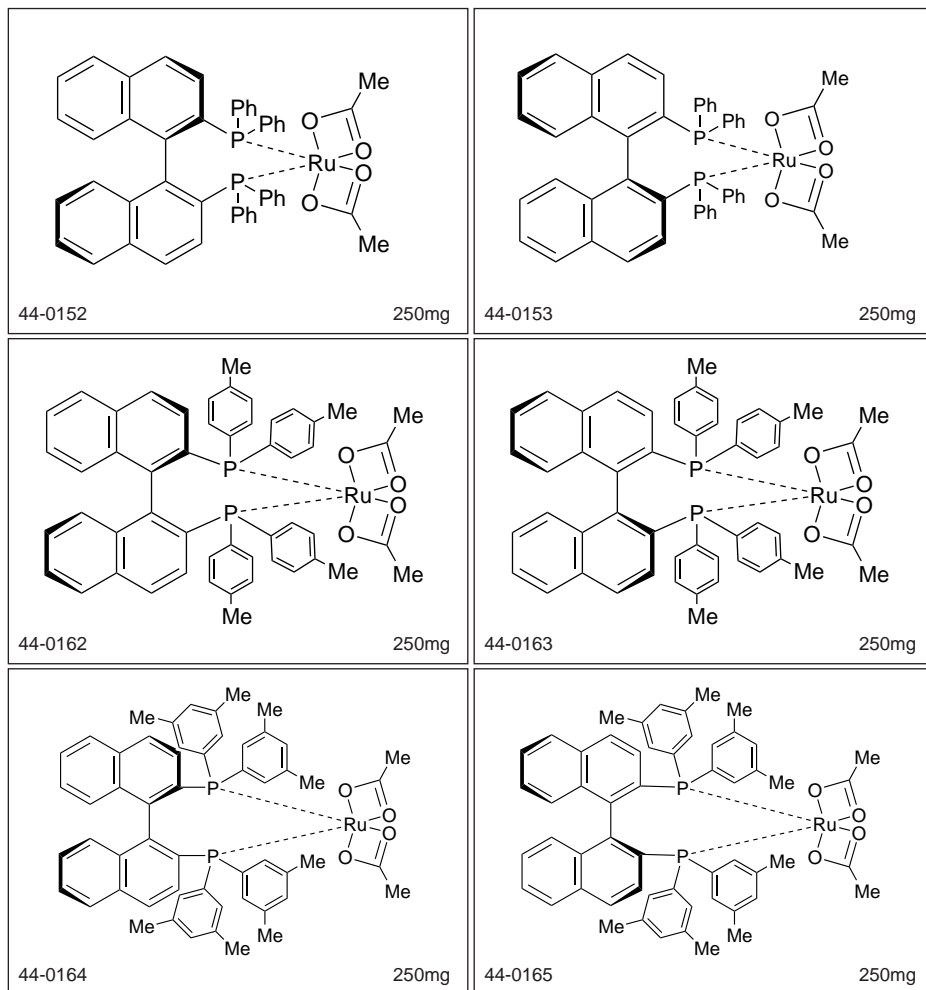

44-0152	Diacetato[(R)-(+)-2,2'-bis(diphenylphosphino)-1,1'-binaphthyl]ruthenium(II) Ru(OAc) ₂ [(R)-binap] (325146-81-4)	250mg	See page 380
44-0153	Diacetato[(S)-(-)-2,2'-bis(diphenylphosphino)-1,1'-binaphthyl]ruthenium(II) Ru(OAc) ₂ [(S)-binap] (261948-85-0)	250mg	See page 380
44-0162	Diacetato[(R)-(+)-2,2'-bis(di-p-tolylphosphino)-1,1'-binaphthyl]ruthenium(II) Ru(OAc) ₂ [(R)-tolbinap] (116128-29-1)	250mg	See page 381
44-0163	Diacetato[(S)-(-)-2,2'-bis(di-p-tolylphosphino)-1,1'-binaphthyl]ruthenium(II) Ru(OAc) ₂ [(S)-tolbinap] (106681-15-6)	250mg	See page 381
44-0164	Diacetato[(R)-(+)-2,2'-bis(di(3,5-xylyl)phosphino)-1,1'-binaphthyl]ruthenium(II) Ru(OAc) ₂ [(R)-xybinap] (374067-50-2)	250mg	See page 381
44-0165	Diacetato[(S)-(-)-2,2'-bis(di(3,5-xylyl)phosphino)-1,1'-binaphthyl]ruthenium(II) Ru(OAc) ₂ [(S)-xybinap] (374067-49-9)	250mg	See page 381

CATALYST & ORGANOCATALYST KITS - Takasago BINAP Ru Cymene Catalyst Kit

96-6951 Takasago BINAP Ru Cymene Catalyst Kit
 Manufactured under license of Takasago patent.
 Components also available for individual sale.
 Contains the following:

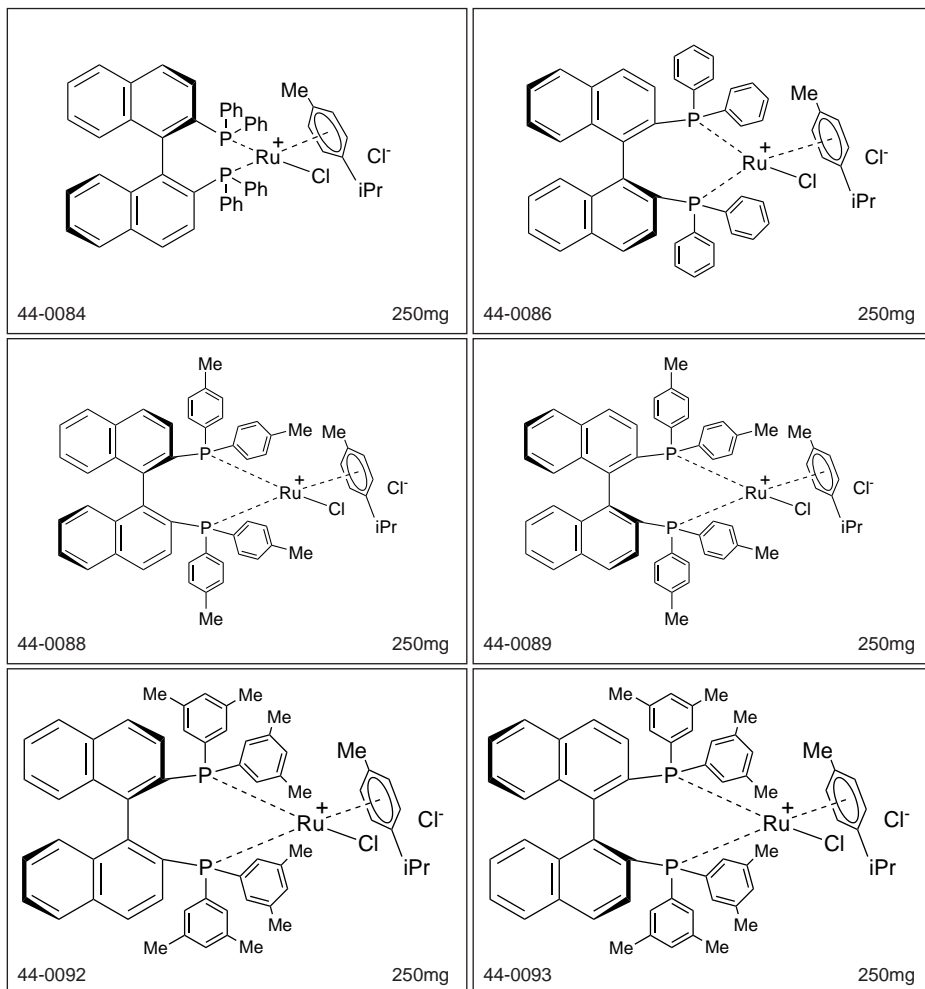

44-0084	Chloro[(R)-(+)-2,2'-bis(diphenylphosphino)-1,1'-binaphthyl](p-cymene)ruthenium(II) chloride [RuCl(p-cymene)((R)-binap)]Cl (145926-28-9)	250mg	See page 373
44-0086	Chloro[(S)-(-)-2,2'-bis(diphenylphosphino)-1,1'-binaphthyl](p-cymene)ruthenium(II) chloride [RuCl(p-cymene)((S)-binap)]Cl (130004-33-0)	250mg	See page 373
44-0088	Chloro[(R)-(+)-2,2'-bis(di-p-tolylphosphino)-1,1'-binaphthyl](p-cymene)ruthenium(II) chloride [RuCl(p-cymene)((R)-tolbinap)]Cl (131614-43-2)	250mg	See page 375
44-0089	Chloro[(S)-(-)-2,2'-bis(di-p-tolylphosphino)-1,1'-binaphthyl](p-cymene)ruthenium(II) chloride [RuCl(p-cymene)((S)-tolbinap)]Cl (228120-95-4)	250mg	See page 375
44-0092	Chloro[(R)-(+)-2,2'-bis(di(3,5-xylyl)phosphino)-1,1'-binaphthyl](p-cymene)ruthenium(II) chloride [RuCl(p-cymene)((R)-xybinap)]Cl (944451-24-5)	250mg	See page 375
44-0093	Chloro[(S)-(-)-2,2'-bis(di(3,5-xylyl)phosphino)-1,1'-binaphthyl](p-cymene)ruthenium(II) chloride [RuCl(p-cymene)((S)-xybinap)]Cl (944451-25-6)	250mg	See page 375

CATALYST & ORGANOCATALYST KITS - Takasago BINAP Ru Diamine Catalyst Kit

96-6954

Takasago BINAP Ru Diamine Catalyst Kit

Manufactured under license of Takasago patent.

Components also available for individual sale.

Contains the following:

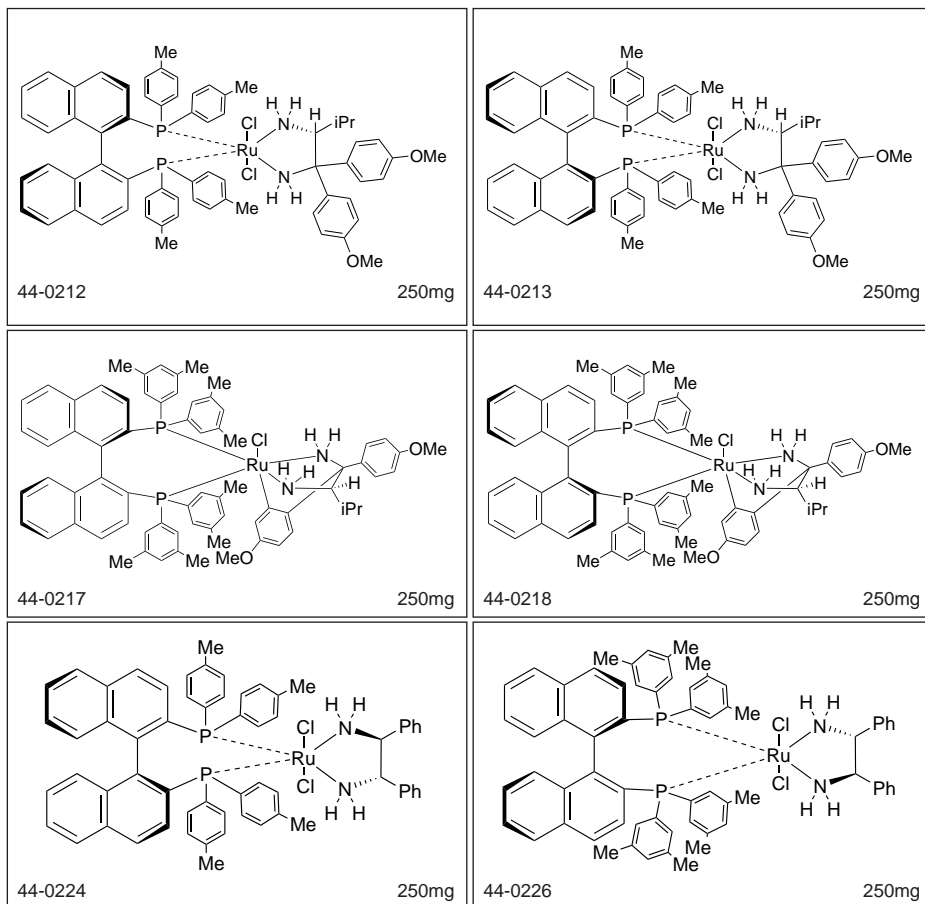

44-0212	Dichloro((R)-(+)-2,2'-bis[di(3,5-xylyl)phosphino]-1,1'-binaphthyl)((2R)-(-)-1,1-bis(4-methoxyphenyl)-3-methyl-1,2-butanediamine)ruthenium(II) RuCl ₂ [(R)-xylbinap][(R)-daipen] (220114-32-9)	250mg	See page 390
44-0213	Dichloro((S)-(-)-2,2'-bis[di(3,5-xylyl)phosphino]-1,1'-binaphthyl)[(2S)-(+)-1,1-bis(4-methoxyphenyl)-3-methyl-1,2-butanediamine]ruthenium(II) RuCl ₂ [(S)-xylbinap][(S)-daipen] (220114-01-2)	250mg	See page 390
44-0217	Chloro((R)-(+)-2,2'-bis[di(3,5-xylyl)phosphino]-1,1'-binaphthyl)[(2R)-(-)-1-(4-methoxyphenyl)-1'-(4-methoxyphenyl-kC)-3-methyl-1,2-butanediamine]ruthenium(II) (R)-RUCY™-XylBINAP (1384974-38-2)	250mg	See page 376
44-0218	Chloro((S)-(-)-2,2'-bis[di(3,5-xylyl)phosphino]-1,1'-binaphthyl)[(2S)-(+)-1-(4-methoxyphenyl)-1'-(4-methoxyphenyl-kC)-3-methyl-1,2-butanediamine]ruthenium(II) (S)-RUCY™-XylBINAP (1312713-89-5)	250mg	See page 376
44-0224	Dichloro((S)-(-)-2,2'-bis[di(3,5-xylyl)phosphino]-1,1'-binaphthyl)[(1S,2S)-(-)-1,2-diphenylethylenediamine]ruthenium(II) RuCl ₂ [(S,S)-xylbinap][(S,S)-dpen] (220114-03-4)	250mg	See page 390
44-0226	Dichloro((R)-(+)-2,2'-bis[di(3,5-xylyl)phosphino]-1,1'-binaphthyl)[(1R,2R)-(+)-1,2-diphenylethylenediamine]ruthenium(II) RuCl ₂ [(R,R)-xylbinap][(R,R)-dpen] (220114-38-5)	250mg	See page 390

CATALYST & ORGANOCATALYST KITS - Takasago BINAP Ru Dimer Catalyst Kit

96-6952 Takasago BINAP Ru Dimer Catalyst Kit
 Manufactured under license of Takasago patent.
 Components also available for individual sale.
 Contains the following:

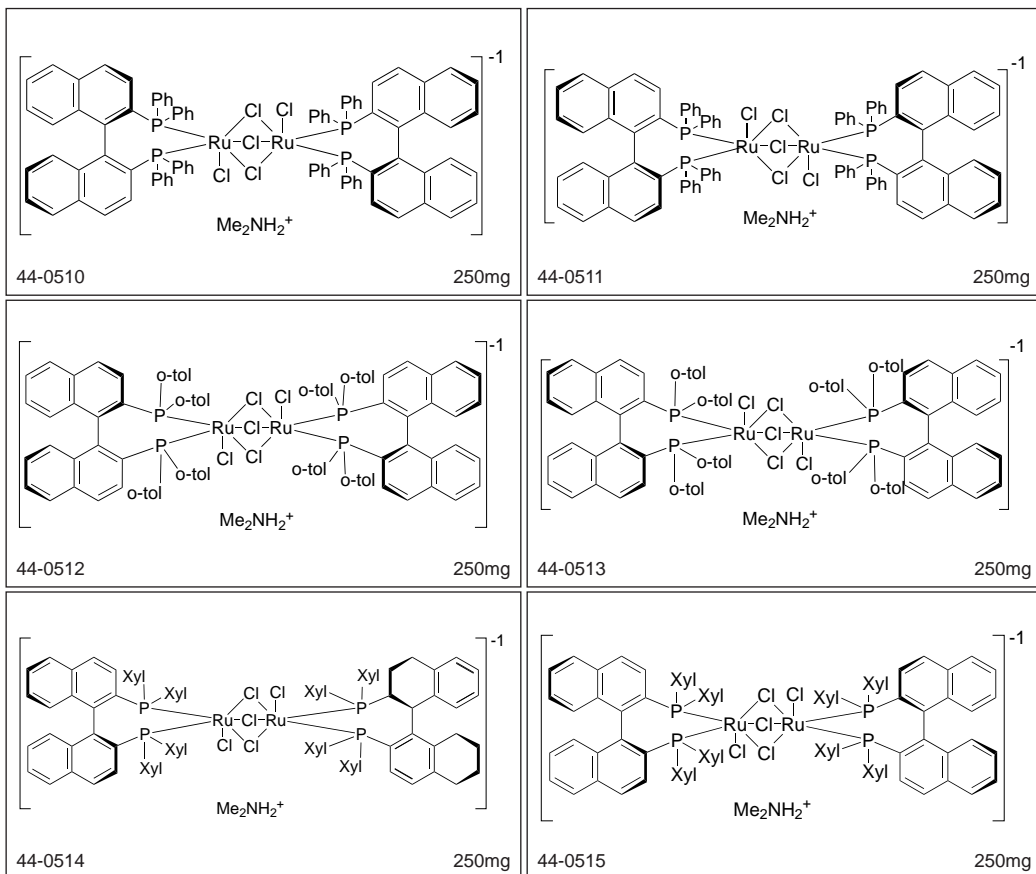

44-0510	Dimethylammonium dichlorotri(μ-chloro)bis[(R)-(+)-2,2'-bis(diphenylphosphino)-1,1'-binaphthyl]diruthenate(II) [NH ₂ Me ₂][{RuCl((R)-binap)} ₂ (μ-Cl) ₃] (199684-47-4)	250mg	See page 395
44-0511	Dimethylammonium dichlorotri(μ-chloro)bis[(S)-(-)-2,2'-bis(diphenylphosphino)-1,1'-binaphthyl]diruthenate(II) [NH ₂ Me ₂][{RuCl((S)-binap)} ₂ (μ-Cl) ₃] (199541-17-8)	250mg	See page 395
44-0512	Dimethylammonium dichlorotri(μ-chloro)bis[(R)-(+)-2,2'-bis(di-p-tolylphosphino)-1,1'-binaphthyl]diruthenate(II) [NH ₂ Me ₂][{RuCl((R)-tolbinap)} ₂ (μ-Cl) ₃] (749935-02-2)	250mg	See page 396
44-0513	Dimethylammonium dichlorotri(μ-chloro)bis[(S)-(-)-2,2'-bis(di-p-tolylphosphino)-1,1'-binaphthyl]diruthenate(II) [NH ₂ Me ₂][{RuCl((S)-tolbinap)} ₂ (μ-Cl) ₃] (309735-86-2)	250mg	See page 396
44-0514	Dimethylammonium dichlorotri(μ-chloro)bis[(R)-(+)-2,2'-bis(di(3,5-xyllyl)phosphino)-1,1'-binaphthyl]diruthenate(II) [NH ₂ Me ₂][{RuCl((R)-xylbinap)} ₂ (μ-Cl) ₃] (944451-08-5)	250mg	See page 394
44-0515	Dimethylammonium dichlorotri(μ-chloro)bis[(S)-(-)-2,2'-bis(di(3,5-xyllyl)phosphino)-1,1'-binaphthyl]diruthenate(II) [NH ₂ Me ₂][{RuCl((S)-xylbinap)} ₂ (μ-Cl) ₃] (944451-10-9)	250mg	See page 394

CATALYST & ORGANOCATALYST KITS - Takasago SEGPHOS® Ru Catalyst Kit

96-6901

Takasago SEGPHOS® Ru Catalyst Kit

Manufactured under license of Takasago patent.

Components also available for individual sale.

Contains the following:

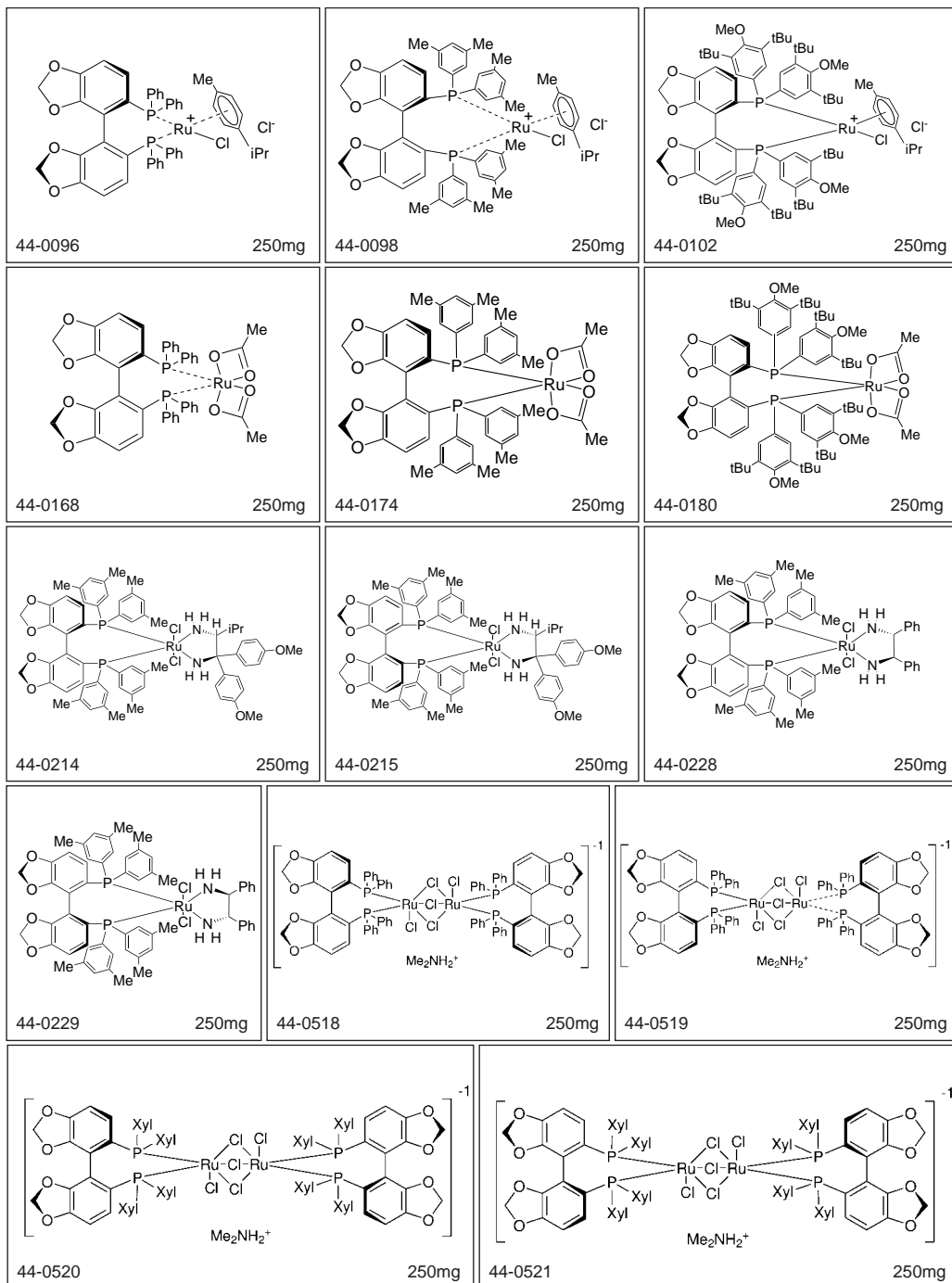

CATALYST & ORGANOCATALYST KITS - Takasago SEGPHOS® Ru Catalyst Kit



44-0096	Chloro[(R)(+)-5,5'-bis(diphenylphosphino)-4,4'-bi-1,3-benzodioxole](p-cymene)ruthenium(II) chloride [RuCl(p-cymene)((R)-segphos®)Cl (944451-28-9)]	250mg	See page 371
44-0097	Chloro[(S)(-)-5,5'-bis(diphenylphosphino)-4,4'-bi-1,3-benzodioxole](p-cymene)ruthenium(II) chloride [RuCl(p-cymene)((S)-segphos®)Cl (944451-29-0)]	250mg	See page 372
44-0098	Chloro[(R)(+)-5,5'-bis[di(3,5-xylyl)phosphino]-4,4'-bi-1,3-benzodioxole](p-cymene)ruthenium(II) chloride [RuCl(p-cymene)((R)-dm-segphos®)Cl (944451-30-3)]	250mg	See page 375
44-0099	Chloro[(S)(-)-5,5'-bis[di(3,5-xylyl)phosphino]-4,4'-bi-1,3-benzodioxole](p-cymene)ruthenium(II) chloride [RuCl(p-cymene)((S)-dm-segphos®)Cl (944451-31-4)]	250mg	See page 375
44-0102	Chloro[(R)(-)-5,5'-bis[di(3,5-di-t-butyl-4-methoxyphenyl)phosphino]-4,4'-bi-1,3-benzodioxole](p-cymene)ruthenium(II) chloride [RuCl(p-cymene)((R)-dtbm-segphos®)Cl (944451-32-5)]	250mg	See page 371
44-0103	Chloro[(S)(+)-5,5'-bis[di(3,5-di-t-butyl-4-methoxyphenyl)phosphino]-4,4'-bi-1,3-benzodioxole](p-cymene)ruthenium(II) chloride [RuCl(p-cymene)((S)-dtbm-segphos®)Cl (944451-33-6)]	250mg	See page 371
44-0168	Diacetato[(R)(+)-5,5'-bis(diphenylphosphino)-4,4'-bi-1,3-benzodioxole]ruthenium(II) Ru(OAc) ₂ [(R)-segphos®] (944450-48-0)	250mg	See page 380
44-0169	Diacetato[(S)(-)-5,5'-bis(diphenylphosphino)-4,4'-bi-1,3-benzodioxole]ruthenium(II) Ru(OAc) ₂ [(S)-segphos®] (373650-12-5)	250mg	See page 380
44-0174	Diacetato[(R)(+)-5,5'-bis[di(3,5-xylyl)phosphino]-4,4'-bi-1,3-benzodioxole]ruthenium(II) Ru(OAc) ₂ [(R)-dm-segphos®] (944450-49-1)	250mg	See page 381
44-0176	Diacetato[(S)(-)-5,5'-bis[di(3,5-xylyl)phosphino]-4,4'-bi-1,3-benzodioxole]ruthenium(II) Ru(OAc) ₂ [(S)-dm-segphos®] (944450-50-4)	250mg	See page 381
44-0180	Diacetato[(R)(-)-5,5'-bis[di(3,5-di-t-butyl-4-methoxyphenyl)phosphino]-4,4'-bi-1,3-benzodioxole]ruthenium(II) Ru(OAc) ₂ [(R)-dtbm-segphos®] (1025477-38-6)	250mg	See page 379
44-0181	Diacetato[(S)(+)-5,5'-bis[di(3,5-di-t-butyl-4-methoxyphenyl)phosphino]-4,4'-bi-1,3-benzodioxole]ruthenium(II) Ru(OAc) ₂ [(S)-dtbm-segphos®] (1025476-84-9)	250mg	See page 380
44-0214	Dichloro[(R)(+)-5,5'-bis[di(3,5-xylyl)phosphino]-4,4'-bi-1,3-benzodioxole][(2R)(-)-1,1-bis(4-methoxyphenyl)-3-methyl-1,2-butanediamine]ruthenium(II) RuCl ₂ [(R)-dm-segphos®][(R)-daipen] (944450-43-5)	250mg	See page 389
44-0215	Dichloro[(S)(-)-5,5'-bis[di(3,5-xylyl)phosphino]-4,4'-bi-1,3-benzodioxole][(2S)(+)-1,1-bis(4-methoxyphenyl)-3-methyl-1,2-butanediamine]ruthenium(II) RuCl ₂ [(S)-dm-segphos®][(S)-daipen] (944450-44-6)	250mg	See page 389
44-0228	Dichloro[(R)(+)-5,5'-bis[di(3,5-xylyl)phosphino]-4,4'-bi-1,3-benzodioxole][(1R,2R)(+)-1,2-diphenylethylenediamine]ruthenium(II) RuCl ₂ [(R)-dm-segphos®][(R,R)-dpen] (944450-45-7)	250mg	See page 389
44-0229	Dichloro[(S)(-)-5,5'-bis[di(3,5-xylyl)phosphino]-4,4'-bi-1,3-benzodioxole][(1S,2S)(-)-1,2-diphenylethylenediamine]ruthenium(II) RuCl ₂ [(S)-dm-segphos®][(S,S)-dpen] (944450-46-8)	250mg	See page 389
44-0518	Dimethylammonium dichlorotri(μ-chloro)bis[(R)(+)-5,5'-bis(diphenylphosphino)-4,4'-bi-1,3-benzodioxole]diruthenate(II) [NH ₂ Me] ₂ [[RuCl((R)-segphos®)] ₂ (μ-Cl)] ₃ (346457-41-8)	250mg	See page 395
44-0519	Dimethylammonium dichlorotri(μ-chloro)bis[(S)(-)-5,5'-bis(diphenylphosphino)-4,4'-bi-1,3-benzodioxole]diruthenate(II) [NH ₂ Me] ₂ [[RuCl((S)-segphos®)] ₂ (μ-Cl)] ₃ (488809-34-3)	250mg	See page 395
44-0520	Dimethylammonium dichlorotri(μ-chloro)bis[(R)(+)-5,5'-bis[di(3,5-xylyl)phosphino]-4,4'-bi-1,3-benzodioxole]diruthenate(II) [NH ₂ Me] ₂ [[RuCl((R)-dm-segphos®)] ₂ (μ-Cl)] ₃ (935449-46-0)	250mg	See page 394
44-0521	Dimethylammonium dichlorotri(μ-chloro)bis[(S)(-)-5,5'-bis[di(3,5-xylyl)phosphino]-4,4'-bi-1,3-benzodioxole]diruthenate(II) [NH ₂ Me] ₂ [[RuCl((S)-dm-segphos®)] ₂ (μ-Cl)] ₃ (944451-14-3)	250mg	See page 394

IONIC LIQUID KITS - Ionic Liquid Kit 1: Hydrophobic (Water-Immiscible) Kit

96-6500 Ionic Liquid Kit 1: Hydrophobic (water-immiscible) Kit

Components also available for individual sale.

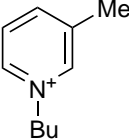
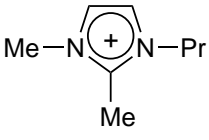
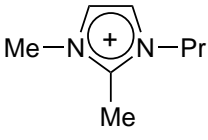
Contains the following:

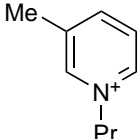
 <p>$[N(SO_2CF_3)_2]^-$</p> <p>07-0180 1g</p>	 <p>$[NH(SO_2CF_3)_2]^-$</p> <p>07-0465 1g</p>	 <p>$(CF_3SO_2)_3C^-$</p> <p>07-0470 500mg</p>
 <p>$[(CF_3CF_2SO_2)_2N]^-$</p> <p>07-0578 500mg</p>	 <p>$[N(SO_2CF_3)_2]^-$</p> <p>07-0579 1g</p>	 <p>$[N(SO_2CF_3)_2]^-$</p> <p>07-1775 1g</p>

07-0180	N-Butyl-3-methylpyridinium bis(trifluoromethylsulfonyl)imide, 99% [BMPIm] (344790-86-9)	1g	See page 82
07-0465	1,2-Dimethyl-3-propylimidazolium bis(trifluoromethylsulfonyl)imide, 99% [DMPIm] (169051-76-7)	1g	See page 82
07-0470	1,2-Dimethyl-3-propylimidazolium tris(trifluoromethylsulfonyl)methide, 99% [DMPiMe] (169051-77-8)	500mg	See page 82
07-0578	1-Ethyl-3-methylimidazolium bis(pentafluoroethylsulfonyl)imide, 99% [EMiBetj] (216299-76-2)	500mg	See page 82
07-0579	1-Ethyl-3-methylimidazolium bis(trifluoromethylsulfonyl)imide, 99% [EMIm] (174899-82-2)	1g	See page 82
07-1775	N-Propyl-3-methylpyridinium bis(trifluoromethylsulfonyl)imide, 99% [PMPIm] (817575-06-7)	1g	See page 83

IONIC LIQUID KITS: Ionic Liquid Kit 2: BMIM Kit**96-6510 Ionic Liquid Kit 2: BMIM Kit**

Components also available for individual sale.

Contains the following:

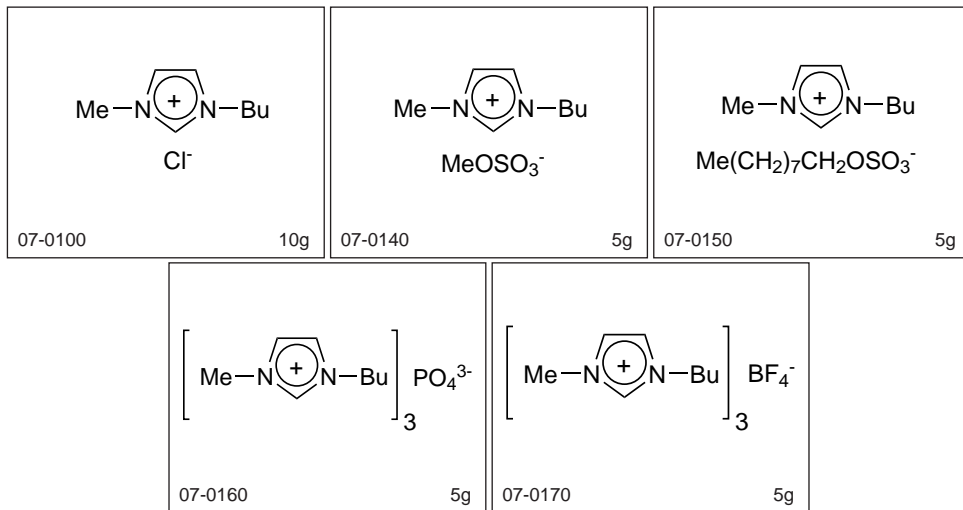

07-0100	1-Butyl-3-methylimidazolium chloride, 98% [BMIM]Cl (79917-90-1)	10g	See page 81
07-0140	1-Butyl-3-methylimidazolium methanesulfonate, 98% [BMIM] [MeSO ₃] (401788-98-5)	5g	See page 81
07-0150	1-Butyl-3-methylimidazolium octylsulfate, 98% [BMIM] [OctSO ₃] (445473-58-5)	5g	See page 81
07-0160	1-Butyl-3-methylimidazolium phosphate, 99% [BMIM] ₃ [PO ₄]	5g	See page 81
07-0170	1-Butyl-3-methylimidazolium tetrafluoroborate, 98% [BMIM] [BF ₄] (174501-65-6)	5g	See page 81

IONIC LIQUID KITS - Ionic Liquid Kit 3: CYPHOS® IL Phosphonium Salt Kit**96-6520 Ionic Liquid Kit 3: CYPHOS® IL Phosphonium Salt Kit**

Components also available for individual sale.

Contains the following:

15-6370	Trihexyl(tetradecyl)phosphonium bis(trifluoromethanesulfonyl)amide, min. 97% CYPHOS® IL 109 (460092-03-9)	10g	See page 83
15-6374	Trihexyl(tetradecyl)phosphonium bis(2,4,4-trimethylpentyl)phosphinate, min. 95% CYPHOS® IL 104 (465527-59-7)	10g	See page 83
15-6378	Trihexyl(tetradecyl)phosphonium bromide, min. 95% CYPHOS® IL 102 (654057-97-3)	10g	See page 84
15-6382	Trihexyl(tetradecyl)phosphonium chloride, min. 93% CYPHOS® IL 101 (258864-54-9)	10g	See page 84
15-6386	Trihexyl(tetradecyl)phosphonium decanoate, min. 95% CYPHOS® IL 103 (465527-65-5)	10g	See page 84
15-6390	Trihexyl(tetradecyl)phosphonium dicyanamide, min. 95% CYPHOS® IL 105	10g	See page 84
15-6394	Trihexyl(tetradecyl)phosphonium hexafluorophosphate, min. 98% CYPHOS® IL 110 (374683-44-0)	10g	See page 84

CYPHOS® IL Registered trademark of Cytec.

References:

1. The Strem Chemiker, Vol. XX, No. 1, 2003 for technical note.

LIGAND KITS - AntPhos and WingPhos Kit

96-3810

AntPhos and WingPhos Kit

Sold in collaboration with Zejun for research purposes only.

Patents ZL201310020371.1, CN 201610056390.

Components also available for individual sale.

Contains the following:

	15-1960	25mg
	15-1963	25mg
	15-1967	25mg
	15-1970	25mg
	15-1975	25mg

15-1960	4-(Anthracen-9-yl)-3-(t-butyl-2,3-dihydrobenzo[d][1,3]oxaphosphole, 98+% rac-AntPhos (1268693-24-8)	25mg	See page 250
15-1963	(R)-4-(Anthracen-9-yl)-3-(t-butyl-2,3-dihydrobenzo[d][1,3]oxaphosphole, 98+% (>99% ee) [(R)-AntPhos] (1456816-37-7)	25mg	See page 251
15-1967	(S)-4-(Anthracen-9-yl)-3-(t-butyl-2,3-dihydrobenzo[d][1,3]oxaphosphole, 99+% (>99% ee) [(S)-AntPhos] (1807740-34-6)	25mg	See page 251
15-1970	(2R,2'R,3R,3'R)-4,4'-Di(anthracen-9-yl)-3,3'-di-t-butyl-2,2',3,3'-tetrahydro-2,2'-bibenzo[d][1,3]oxaphosphole, min 98% (>90% ee), [(2R,2'R,3R,3'R)-WingPhos] (1884680-45-8)	25mg	See page 285
15-1975	((2S,2'S,3S,3'S)-4,4'-Di(anthracen-9-yl)-3,3'-di-t-butyl-2,2',3,3'-tetrahydro-2,2'-bibenzo[d][1,3]oxaphosphole, min 98%, (>99% ee), [(2S,2'S,3S,3'S)-WingPhos] (1435940-19-4)	25mg	See page 285

LIGAND KITS - 1,1'-Bis(dialkyl/diarylphosphino)ferrocene Ligand Kit**96-3730 1,1'-Bis(dialkyl/diarylphosphino)ferrocene Ligand Kit**

Components also available for individual sale.

Contains the following:

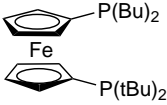
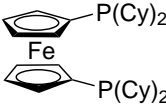
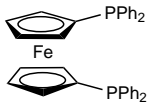
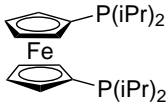
			
26-0150 500mg	26-0155 500mg	26-0270 1g	26-0275 500mg

26-0150	1,1'-Bis(di-t-butylphosphino)ferrocene, min. 98% DTBPF (84680-95-5)	500mg	See page 95
26-0155	1,1'-Bis(dicyclohexylphosphino)ferrocene, min. 98% (146960-90-9)	500mg	See page 95
26-0270	1,1'-Bis(diphenylphosphino)ferrocene, 99% DPPF (12150-46-8)	1g	See page 97
26-0275	1,1'-Bis(di-i-propylphosphino)ferrocene, min. 98% DiPPF (97239-80-0)	500mg	See page 98

LIGAND KITS - Buchwald Biaryl Phosphine Ligand Master Kit**96-5500 Buchwald Biaryl Phosphine Ligand Master Kit for Aromatic Carbon-Heteroatom Bond Formation, Suzuki Coupling and Negishi Cross-coupling**

For aromatic carbon-heteroatom bond formation and Suzuki Coupling.



Patents: US 6,395,916, US 6,307,087

Components also available for individual sale.

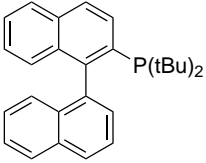
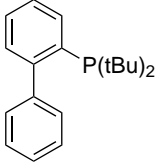
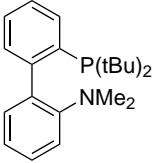
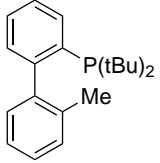
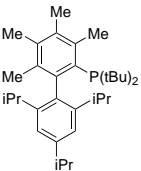
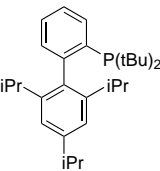
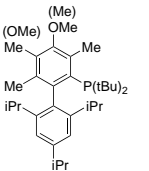
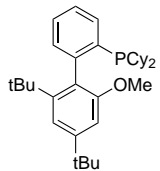
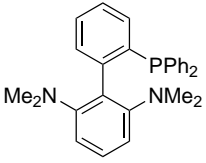
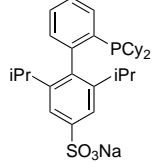
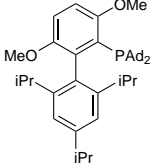
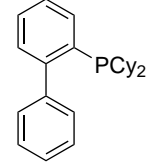
Contains the following:

			
15-1043 250mg	15-1045 500mg	15-1048 500mg	15-1049 500mg
			
15-1051 250mg	15-1052 500mg	15-1063 250mg	15-1105 250mg
			
15-1125 100mg	15-1135 100mg	15-1138 100mg	15-1140 1g

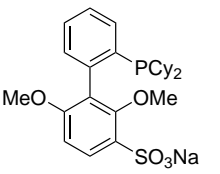
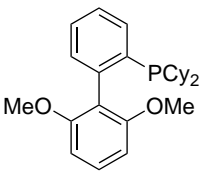
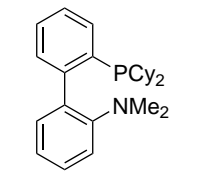
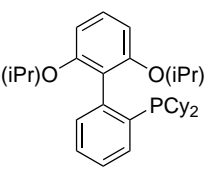
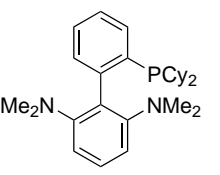
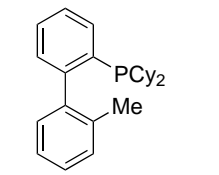
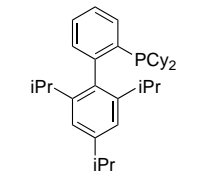
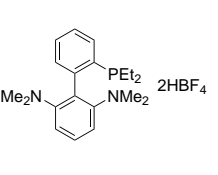
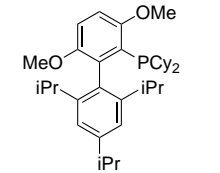
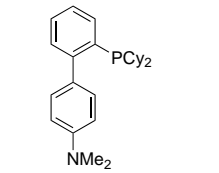
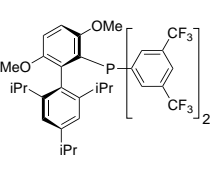
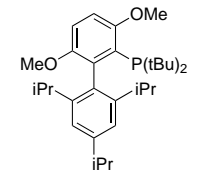
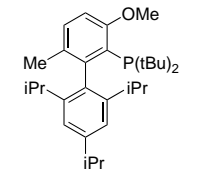
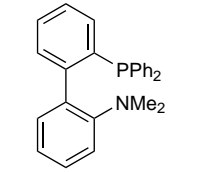
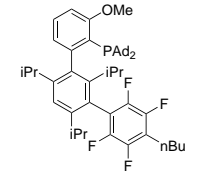
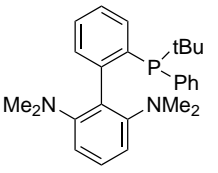
LIGAND KITS - Buchwald Biaryl Phosphine Ligand Master Kit

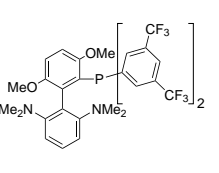
			
15-1142 500mg	15-1143 500mg	15-1145 500mg	15-1146 1g
			
15-1147 250mg	15-1148 500mg	15-1149 500mg	15-1151 100mg
			
15-1152 250mg	15-1154 250mg	15-1157 100mg	15-1164 100mg
			
15-1168 100mg	15-1745 500mg	15-2065 100mg	15-3010 250mg
			
15-3015 100mg	15-3020 250mg		

15-1043	racemic-2-Di-t-butylphosphino-1, 1'-binaphthyl, 98% TrixiePhos (255836-67-0)	250mg	See page 288
15-1045	2-(Di-t-butylphosphino)-1,1'-biphenyl, 99% JohnPhos (224311-51-7)	500mg	See page 288
15-1048	2-Di-t-butylphosphino-2'-(N,N-dimethylamino)-1,1'-biphenyl, 98% tBuDavePhos (224311-49-3)	500mg	See page 289
15-1049	2-Di-t-butylphosphino-2'-methyl)-1,1'-biphenyl, 99% t-BuMePhos (255837-19-5)	500mg	See page 289
15-1051	2-Di-t-butylphosphino-3,4,5,6-tetramethyl-2',4',6'-tri-i-propyl)-1,1'-biphenyl, min. 98% Me, t-BuXPhos (857356-94-6)	250mg	See page 290

LIGAND KITS - Buchwald Biaryl Phosphine Ligand Master Kit

15-1052	2-Di-t-butylphosphino-2',4',6'-tri-i-propyl-1,1'-biphenyl, min. 98% t-BuXPhos (564483-19-8)	500mg	See page 290
15-1063	2-Di-t-butylphosphino-4-methoxy-3,5,6-trimethyl-2',4',6'-tri-i-propyl-1,1'-biphenyl, min. 98% [~1:1 mixture with regioisomer, 2-Di-t-butylphosphino-5-methoxy-3,4,6-trimethyl-2',4',6'-tri-i-propylbiphenyl] (1359986-21-2)	250mg	See page 289
15-1105	2-Dicyclohexylphosphino-2'-methoxy-4',6'-di-t-butyl-1,1'-biphenyl, min. 98% VPhos (1848244-75-6)	250mg	See page 294
15-1125	2-Diphenylphosphino-2',6'-bis(dimethylamino)-1,1'-biphenyl, min. 98% PhCPhos (1447963-71-4)	100mg	See page 303
15-1135	2'-Dicyclohexylphosphino-2,6-di-i-propyl-4-sulfonato-1,1'-biphenyl hydrate sodium salt (XPhos-SO ₃ Na) (870245-84-4)	100mg	See page 293
15-1138	2-(Di-1-adamantylphosphino)-3,6-dimethoxy-2',4',6'-tri-i-propyl-1,1'-biphenyl, min. 95% AdBrettPhos (1160861-59-5)	100mg	See page 284
15-1140	2-(Dicyclohexylphosphino)-1,1'-biphenyl, 98% CyJohnPhos (247940-06-3)	1g	See page 292
15-1142	2'-Dicyclohexylphosphino-2,6-dimethoxy-3-sulfonato-1,1'-biphenyl hydrate sodium salt (water soluble SPhos), min. 98% (1049726-96-6)	500mg	See page 292
15-1143	2-Dicyclohexylphosphino-2',6'-dimethoxy-1,1'-biphenyl, min. 98% SPhos (657408-07-6)	500mg	See page 292
15-1145	2-(Dicyclohexylphosphino)-2'-(N,N-dimethylamino)-1,1'-biphenyl, 98% DavePhos (213697-53-1)	500mg	See page 293
15-1146	2-Dicyclohexylphosphino-2',6'-di-i-propoxy-1,1'-biphenyl, min. 98% RuPhos (787618-22-8)	1g	See page 293
15-1147	2-Dicyclohexylphosphino-2',6'-bis(dimethylamino)-1,1'-biphenyl, min. 98% CPhos (1160556-64-8)	250mg	See page 292
15-1148	2-Dicyclohexylphosphino-2'-methyl-1,1'-biphenyl, min. 98% MePhos (251320-86-2)	500mg	See page 294
15-1149	2-(Dicyclohexylphosphino)-2',4',6'-tri-i-propyl-1,1'-biphenyl, min. 98% XPhos (564483-18-7)	500mg	See page 295
15-1151	2-Diethylphosphino-2',6'-bis(dimethylamino)-1,1'-biphenyl di(hydrogen tetrafluoroborate) salt, min. 98% EtCPhos	100mg	See page 296
15-1152	2-(Dicyclohexylphosphino)-3,6-dimethoxy-2',4',6'-tri-i-propyl-1,1'-biphenyl, min. 98% BrettPhos (1070663-78-3)	250mg	See page 293
15-1154	2-Dicyclohexylphosphino-4'-(N,N-dimethylamino)-1,1'-biphenyl, 98% (1185899-00-6)	250mg	See page 293
15-1157	2-Di[3,5-bis(trifluoromethyl)phenylphosphino]-3,6-dimethoxy-2',4',6'-tri-i-propyl-1,1'-biphenyl, min. 98% JackiePhos (1160861-60-8)	100mg	See page 285
15-1164	2-(Di-t-butylphosphino)-3,6-dimethoxy-2',4',6'-tri-i-propyl-1,1'-biphenyl, min. 98% t-BuBrettPhos (1160861-53-9)	100mg	See page 288
15-1168	2-(Di-t-butylphosphino)-3-methoxy-6-methyl-2',4',6'-tri-i-propyl-1,1'-biphenyl, min. 98% RockPhos (1262046-34-3)	100mg	See page 289
15-1745	2-Diphenylphosphino-2'-(N,N-dimethylamino)-1,1'-biphenyl, 98% PhDavePhos (240417-00-9)	500mg	See page 304
15-2065	2-(Diadamantylphosphino)-3-methoxy-2',4',6'-tri-i-propyl-3'-(2,3,5,6-tetrafluoro-4-butylphenyl)-1,1'-biphenyl AlPhos (1805783-60-1)	100mg	See page 284
15-3010	2-(t-Butylphenylphosphino)-2',6'-dimethylamino-1,1'-biphenyl, 98% (t-Bu)PhCPhos (1660153-91-2)	250mg	See page 282
15-3015	2-[Bis(3,5-trifluoromethylphenylphosphino)-3,6-dimethoxy]-2',6'-dimethylamino-1,1'-biphenyl, 98% (1810068-30-4)	100mg	See page 280
15-3020	2-[Bis(3,5-trifluoromethylphenylphosphino)-3,6-dimethoxy]-2',6'-di-i-propoxy-1,1'-biphenyl, 98% (1810068-31-5)	250mg	See page 280

LIGAND KITS - Buchwald Biaryl Phosphine Ligand Mini Kit 1

96-5485

Buchwald Biaryl Phosphine Ligand Mini Kit 1 for Aromatic Carbon-Heteroatom Bond Formation, Suzuki Coupling and Negishi Cross-coupling

For aromatic carbon-heteroatom bond formation and Suzuki Coupling.

Patents: US 6,395,916, US 6,307,087

Components also available for individual sale. Contains the following:

15-1051 250mg	15-1052 500mg	15-1138 100mg
15-1143 500mg	15-1146 1g	15-1149 500mg
15-1152 250mg	15-1157 100mg	15-1164 100mg

15-1051	2-Di- <i>t</i> -butylphosphino-3,4,5,6-tetramethyl-2',4',6'-tri- <i>i</i> -propyl-1,1'-biphenyl, min. 98% Me ₄ <i>t</i> -BuXPhos (857356-94-6)	250mg	See page 290
15-1052	2-Di- <i>t</i> -butylphosphino-2',4',6'-tri- <i>i</i> -propyl-1,1'-biphenyl, min. 98% <i>t</i> -BuXPhos (564483-19-8)	500mg	See page 290
15-1138	2-(Di-1-adamantylphosphino)-3,6-dimethoxy-2',4',6'-tri- <i>i</i> -propyl-1,1'-biphenyl, min. 95% AdBrettPhos (1160861-59-5)	100mg	See page 284
15-1143	2-Dicyclohexylphosphino-2',6'-dimethoxy-1,1'-biphenyl, min. 98% SPhos (657408-07-6)	500mg	See page 292
15-1146	2-Dicyclohexylphosphino-2',6'-di- <i>i</i> -propoxy-1,1'-biphenyl, min. 98% RuPhos (787618-22-8)	1g	See page 293
15-1149	2-(Dicyclohexylphosphino)-2',4',6'-tri- <i>i</i> -propyl-1,1'-biphenyl, min. 98% XPhos (564483-18-7)	500mg	See page 295
15-1152	2-(Dicyclohexylphosphino)-3,6-dimethoxy-2',4',6'-tri- <i>i</i> -propyl-1,1'-biphenyl, min. 98% BrettPhos (1070663-78-3)	250mg	See page 293
15-1157	2-Di[3,5-bis(trifluoromethyl)phenyl]phosphino-3,6-dimethoxy-2',4',6'-tri- <i>i</i> -propyl-1,1'-biphenyl, min. 98% JackiePhos (1160861-60-8)	100mg	See page 285
15-1164	2-(Di- <i>t</i> -butylphosphino)-3,6-dimethoxy-2',4',6'-tri- <i>i</i> -propyl-1,1'-biphenyl, min. 98% <i>t</i> -BuBrettPhos (1160861-53-9)	100mg	See page 288

LIGAND KITS - Buchwald Biaryl Phosphine Ligand Mini Kit 2**96-5490 Buchwald Biaryl Phosphine Ligand Mini Kit 2 for Aromatic Carbon-Heteroatom Bond Formation, Suzuki Coupling and Negishi Cross-coupling**

For aromatic carbon-heteroatom bond formation and Suzuki Coupling.

Patents: US 6,395,916, US 6,307,087

Components also available for individual sale.

Contains the following:

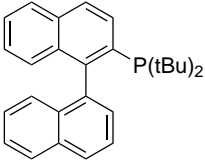
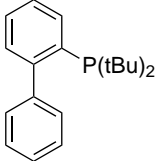
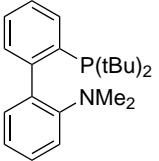
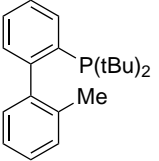
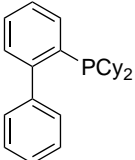
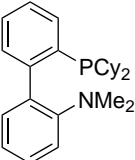
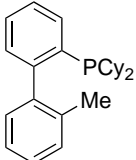
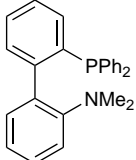
			
15-1043 250mg	15-1045 500mg	15-1048 500mg	15-1049 500mg
			
15-1140 1g	15-1145 500mg	15-1148 500mg	15-1745 500mg

15-1043	racemic-2-Di-t-butylphosphino-1, 1'-binaphthyl, 98% TrixiePhos (255836-67-0)	250mg	See page 288
15-1045	2-(Di-t-butylphosphino)-1,1'-biphenyl, 99% JohnPhos (224311-51-7)	500mg	See page 288
15-1048	2-Di-t-butylphosphino-2'-(N,N-dimethylamino)-1,1'-biphenyl, 98% tBuDavePhos (224311-49-3)	500mg	See page 289
15-1049	2-Di-t-butylphosphino-2'-methyl-1,1'-biphenyl, 99% t-BuMePhos (255837-19-5)	500mg	See page 289
15-1140	2-(Dicyclohexylphosphino)-1,1'-biphenyl, 98% CyJohnPhos (247940-06-3)	1g	See page 292
15-1145	2-(Dicyclohexylphosphino)-2'-(N,N-dimethylamino)-1,1'-biphenyl, 98% DavePhos (213697-53-1)	500mg	See page 293
15-1148	2-Dicyclohexylphosphino-2'-methyl-1,1'-biphenyl, min. 98% MePhos (251320-86-2)	500mg	See page 294
15-1745	2-Diphenylphosphino-2'-(N,N-dimethylamino)-1,1'-biphenyl, 98% PhDavePhos (240417-00-9)	500mg	See page 304

LIGAND KITS - Buchwald Biaryl Phosphine Ligand Mini Kit 3**96-5495 Buchwald Biaryl Phosphine Ligand Mini Kit 3 for Aromatic Carbon-Heteroatom Bond Formation, Suzuki Coupling and Negishi Cross-coupling****NEW**

For aromatic carbon-heteroatom bond formation and Suzuki Coupling.

Patents: US 6,395,916, US 6,307,087.

Components also available for individual sale.

Contains the following:

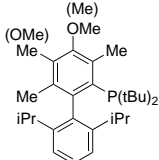
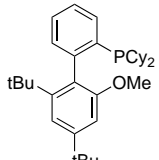
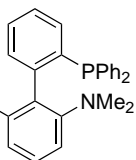
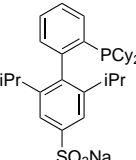
			
15-1063 250mg	15-1105 250mg	15-1125 100mg	15-1135 100mg

LIGAND KITS - Buchwald Biaryl Phospine Ligand Mini Kit 3

	15-1142	500mg
	15-1147	250mg
	15-1151	100mg
	15-1154	250mg
	15-1168	100mg
	15-2065	100mg
	15-3010	250mg
	15-3015	100mg
	15-3020	250mg

15-1063	2-Di-tert-butylphosphino-4-methoxy-3,5,6-trimethyl-2',4',6'-tri-tert-propyl-1,1'-biphenyl, min. 98% [~1:1 mixture with regioisomer, 2-Di-tert-butylphosphino-5-methoxy-3,4,6-trimethyl-2',4',6'-tri-tert-propylbiphenyl] (1359986-21-2)	250mg	See page 289
15-1105	2-Dicyclohexylphosphino-2'-methoxy-4',6'-di-tert-butyl-1,1'-biphenyl, min. 98% VPhos (1848244-75-6)	250mg	See page 294
15-1125	2-Diphenylphosphino-2',6'-bis(dimethylamino)-1,1'-biphenyl, min. 98% PhCPhos (1447963-71-4)	100mg	See page 303
15-1135	2'-Dicyclohexylphosphino-2,6-di-tert-propyl-4-sulfonato-1,1'-biphenyl hydrate sodium salt (XPhos-SO ₃ Na) (870245-84-4)	100mg	See page 293
15-1142	2'-Dicyclohexylphosphino-2,6-dimethoxy-3-sulfonato-1,1'-biphenyl hydrate sodium salt (water soluble SPhos), min. 98% (1049726-96-6)	500mg	See page 292
15-1147	2-Dicyclohexylphosphino-2',6'-bis(dimethylamino)-1,1'-biphenyl, min. 98% CPhos (1160556-64-8)	250mg	See page 292
15-1151	2-Diethylphosphino-2',6'-bis(dimethylamino)-1,1'-biphenyl di(hydrogen tetrafluoroborate) salt, min. 98% EtCPhos	100mg	See page 296
15-1154	2-Dicyclohexylphosphino-4'-(N,N-dimethylamino)-1,1'-biphenyl, 98% (1185899-00-6)	250mg	See page 293
15-1168	2-(Di-tert-butylphosphino)-3-methoxy-6-methyl-2',4',6'-tri-tert-propyl-1,1'-biphenyl, min. 98% RockPhos (1262046-34-3)	100mg	See page 289
15-2065	2-(Diadamantylphosphino)-3-methoxy-2',4',6'-tri-tert-propyl-3'-(2,3,5,6-tetrafluoro-4-butylphenyl)-1,1'-biphenyl AlPhos (1805783-60-1)	100mg	See page 284
15-3010	2-(tert-Butylphenylphosphino)-2',6'-dimethylamino-1,1'-biphenyl, 98% (t-Bu)PhCPhos (1660153-91-2)	250mg	See page 282
15-3015	2-[Bis(3,5-trifluoromethylphenylphosphino)-3,6-dimethoxy]-2',6'-dimethylamino-1,1'-biphenyl, 98% (1810068-30-4)	100mg	See page 280
15-3020	2-[Bis(3,5-trifluoromethylphenylphosphino)-3,6-dimethoxy]-2',6'-di-tert-propoxy-1,1'-biphenyl, 98% (1810068-31-5)	250mg	See page 280

LIGAND KITS - Chiral SpiroPAP Ligand Kit

96-0445

Chiral SpiroPAP Ligand Kit**NEW**

Also available: 77-4035 [Ir-(R)-DTB-SpiroPAP-3-Me] and 77-4036 [Ir-(S)-DTB-SpiroPAP-3-Me]
(not part of the kit)

Components also available for individual sale.

Contains the following:

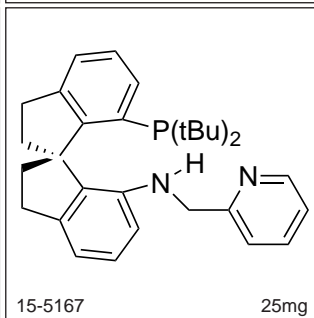
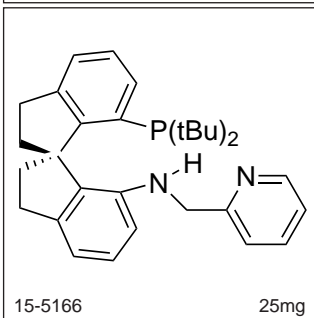
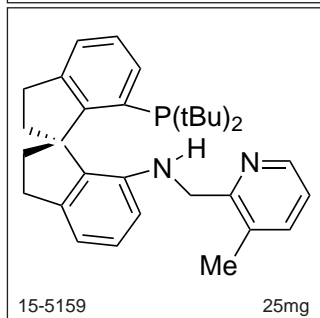
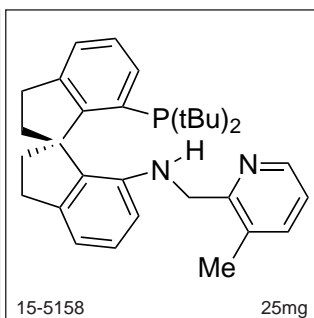
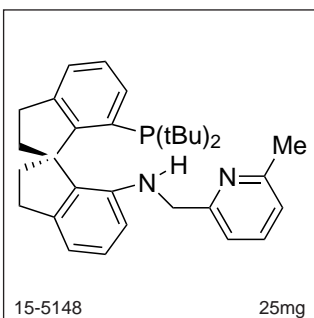
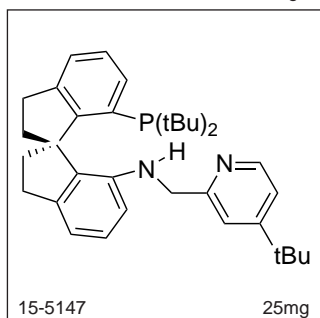

15-5147	(R)-(+)-7-Bis(3,5-di-t-butylphenyl)phosphino-7'-[(4-t-butylpyridine-2-ylmethyl)amino]-2,2',3,3'-tetrahydro-1,1'-spirobiindane, min. 98% (>99% ee) (R)-DTB-SpiroPAP-4-t-Bu (1298133-38-6)	25mg	See page 256
15-5148	(R)-(+)-7-Bis(3,5-di-t-butylphenyl)phosphino-7'-[(6-methylpyridine-2-ylmethyl)amino]-2,2',3,3'-tetrahydro-1,1'-spirobiindane, min. 98% (>99% ee) (R)-DTB-SpiroPAP-6-Me (1298133-26-2)	25mg	See page 257
15-5158	(R)-(+)-7-Bis(3,5-di-t-butylphenyl)phosphino-7'-[(3-methylpyridine-2-ylmethyl)amino]-2,2',3,3'-tetrahydro-1,1'-spirobiindane, min. 98% (>99% ee) (R)-DTB-SpiroPAP-3-Me (1298133-36-4)	25mg	See page 256
15-5159	(S)-(-)-7-Bis(3,5-di-t-butylphenyl)phosphino-7'-[(3-methylpyridine-2-ylmethyl)amino]-2,2',3,3'-tetrahydro-1,1'-spirobiindane, min. 98% (>99% ee) (S)-DTB-SpiroPAP-3-Me	25mg	See page 257
15-5166	(R)-(+)-7-Bis(3,5-di-t-butylphenyl)phosphino-7'-[(pyridine-2-ylmethyl)amino]-2,2',3,3'-tetrahydro-1,1'-spirobiindane, min. 98% (>99% ee) (R)-DTB-SpiroPAP (1298133-21-7)	25mg	See page 257
15-5167	(S)-(-)-7-Bis(3,5-di-t-butylphenyl)phosphino-7'-[(pyridine-2-ylmethyl)amino]-2,2',3,3'-tetrahydro-1,1'-spirobiindane, min. 98% (>99% ee) (S)-DTB-SpiroPAP (1415636-82-6)	25mg	See page 257

LIGAND KITS - Chiral SpiroSAP Ligand Kit

96-0070

Chiral SpiroSAP Ligand Kit

Also available: 77-2510 [Ir-(R)-DTB-SpiroSAP] and 77-2511 [Ir-(S)-DTB-SpiroSAP]

(not part of the kit)

Components also available for individual sale.

Contains the following:

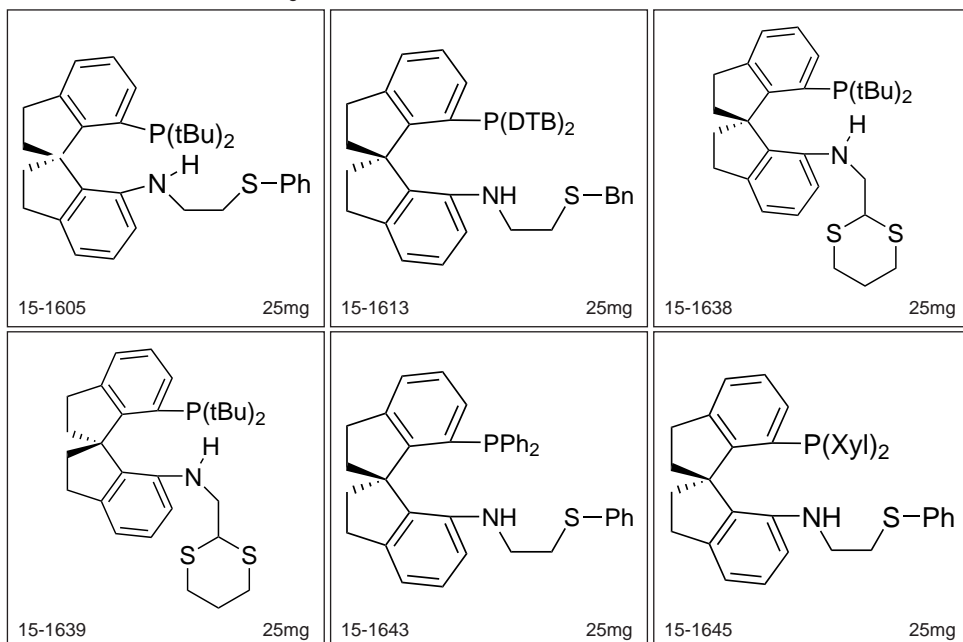

15-1605	(R)-(+)-7-[N-(2-Phenylthio)ethylamino]-7'-[bis(3,5-di-t-butylphenyl)phosphino]-2,2',3,3'-tetrahydro-1,1'-spirobindane, 97+% (>99% ee) [(R)-DTB-SpiroSAP-Ph] (1809609-38-8)	25mg	See page 319
15-1613	(R)-(+)-7-[N-(2-Benzylthio)ethylamino]-7'-[bis(3,5-di-t-butylphenyl)phosphino]-2,2',3,3'-tetrahydro-1,1'-spirobindane, 97+% (>99% ee) [(R)-DTB-SpiroSAP-Bn] (1809609-52-6)	25mg	See page 252
15-1638	(R)-(+)-7-[N-(1,3-Dithian-2-yl)methylamino]-7'-[bis(3,5-di-t-butylphenyl)phosphino]-2,2',3,3'-tetrahydro-1,1'-spirobindane, 97+% (>99% ee) [(R)-DTB-SpiroSAP] (1809609-53-7)	25mg	See page 311
15-1639	(S)-(-)-7-[N-(1,3-Dithian-2-yl)methylamino]-7'-[bis(3,5-di-t-butylphenyl)phosphino]-2,2',3,3'-tetrahydro-1,1'-spirobindane, 97+% (>99% ee) [(S)-DTB-SpiroSAP]	25mg	See page 311
15-1643	(R)-(+)-7-[N-(2-Phenylthio)ethylamino]-7'-[diphenylphosphino]-2,2',3,3'-tetrahydro-1,1'-spirobindane, 97+% (>99% ee) [(R)-Ph-SpiroSAP-Ph] (1809609-40-2)	25mg	See page 319
15-1645	(R)-(+)-7-[N-(2-Phenylthio)ethylamino]-7'-[bis(3,5-dimethylphenyl)phosphino]-2,2',3,3'-tetrahydro-1,1'-spirobindane, 97+% (>99% ee) [(R)-Xyl-SpiroSAP-Ph] (1809609-39-9)	25mg	See page 319

LIGAND KITS - DSM MonoPhos™ Ligand Kit

96-5650

DSM MonoPhos™ Ligand Kit

For asymmetric catalytic hydrogenations and other transformations.

Sold in collaboration with DSM for research purposes only.

Components also available for individual sale. Contains the following:

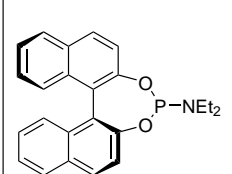
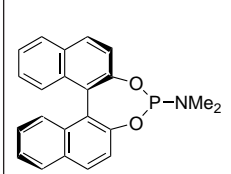
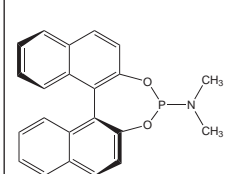
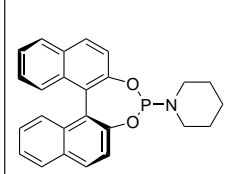
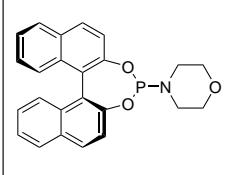
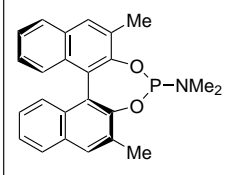
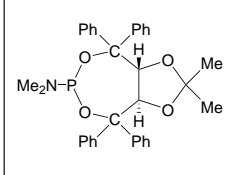
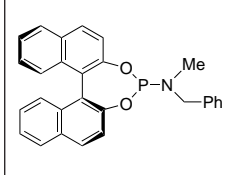
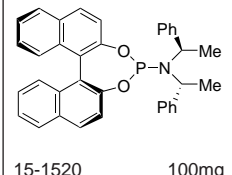
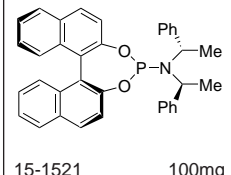
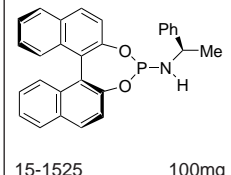
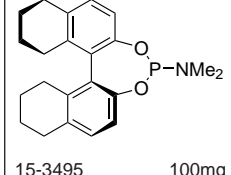
			
15-1231 250mg	15-1232 1g	15-1233 1g	15-1234 100mg
			
15-1235 100mg	15-1255 100mg	15-1505 100mg	15-1510 100mg
			
15-1520 100mg	15-1521 100mg	15-1525 100mg	15-3495 100mg

15-1231	(S)-(+)-(3,5-Dioxa-4-phospha-cyclohepta[2,1-a;3,4-a']dinaphthalen-4-yl)diethylamine, min. 97% (252288-04-3)	250mg	See page 302
15-1232	(R)-(-)-(3,5-Dioxa-4-phospha-cyclohepta[2,1-a;3,4-a']dinaphthalen-4-yl)dimethylamine, min. 97% (R)-MONOPHOS (157488-65-8)	1g	See page 302
15-1233	(S)-(+)-(3,5-Dioxa-4-phospha-cyclohepta[2,1-a;3,4-a']dinaphthalen-4-yl)dimethylamine, min. 97% (S)-MONOPHOS (185449-80-3)	1g	See page 302
15-1234	(S)-(+)-(3,5-Dioxa-4-phospha-cyclohepta[2,1-a;3,4-a']dinaphthalen-4-yl)piperidine, min. 97% (S)-PipPhos (284472-79-3)	100mg	See page 302
15-1235	(S)-(+)-(3,5-Dioxa-4-phospha-cyclohepta[2,1-a;3,4-a']dinaphthalen-4-yl)morpholine, min. 97% (S)-MorPhos (185449-81-4)	100mg	See page 302
15-1255	(S)-(+)-(2,6-Dimethyl-3,5-dioxa-4-phospha-cyclohepta[2,1-a;3,4-a']dinaphthalen-4-yl)dimethylamine, min. 98% (185449-86-9)	100mg	See page 298
15-1505	(3aR,8aR)-(-)-(2,2-Dimethyl-4,4,8,8-tetraphenyl-tetrahydro-[1,3]dioxolo[4,5-e][1,3,2]dioxaphosphepin-6-yl)dimethylamine, min. 98% (213843-90-4)	100mg	See page 300
15-1510	(S)-(+)-(3,5-Dioxa-4-phospha-cyclohepta[2,1-a;3,4-a']dinaphthalen-4-yl)benzyl(methyl)amine, 99% (490023-37-5)	100mg	See page 301
15-1520	(S)-(+)-(3,5-Dioxa-4-phospha-cyclohepta[2,1-a;3,4-a']dinaphthalen-4-yl)bis[(1R)-1-phenylethyl]amine, dichloromethane adduct, min. 95% (415918-91-1)	100mg	See page 301
15-1521	(S)-(+)-(3,5-Dioxa-4-phospha-cyclohepta[2,1-a;3,4-a']dinaphthalen-4-yl)bis[(1S)-1-phenylethyl]amine, min. 95% (380230-02-4)	100mg	See page 301
15-1525	(S)-(+)-(3,5-Dioxa-4-phospha-cyclohepta[2,1-a;3,4-a']dinaphthalen-4-yl)[(1R)-1-phenylethyl]amine, min. 95% (422509-53-3)	100mg	See page 302
15-3495	(S)-(+)-(8,9,10,11,12,13,14,15-Octahydro-3,5-dioxa-4-phospha-cyclohepta[2,1-a;3,4-a']dinaphthalen-4-yl)dimethylamine, 99% (389130-06-7)	100mg	See page 317

LIGAND KITS - Enantiotech BIMAH Ligand Kit**96-3700 Enantiotech BIMAH Ligand Kit for Asymmetric Hydrogenation**

Sold under license from Enantiotech for research purposes only.

PCT/CN2008/073648, CN 200810038929.

Components also available for individual sale.

Contains the following:

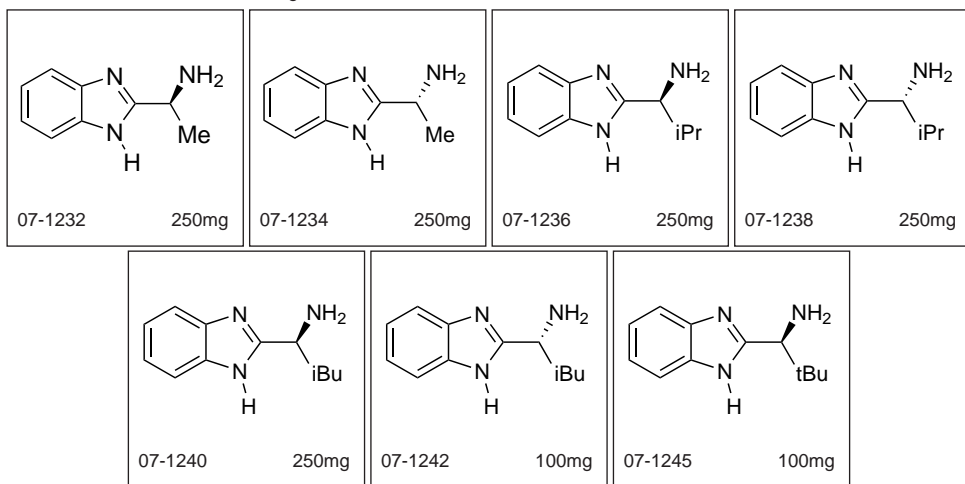

07-1232	(S)-(-)-2-(α -methylmethanamine)-1H-benzimidazole, min. 98% (S)-Me-BIMAH (925689-54-9)	250mg	See page 203
07-1234	(R)-(+)-2-(α -methylmethanamine)-1H-benzimidazole, min. 98% (R)-Me-BIMAH (163959-79-3)	250mg	See page 203
07-1236	(S)-(-)-2-(α -(i-propyl)methanamine)-1H-benzimidazole, min. 98% (S)-i-Pr-BIMAH (59653-66-6)	250mg	See page 206
07-1238	(R)-(+)-2-(α -(i-propyl)methanamine)-1H-benzimidazole, min. 98% (R)-i-Pr-BIMAH (1235024-08-4)	250mg	See page 206
07-1240	(S)-(-)-2-(α -(i-butyl)methanamine)-1H-benzimidazole, min. 98% (S)-i-Bu-BIMAH (59592-31-3)	250mg	See page 190
07-1242	(R)-(+)-2-(α -(i-butyl)methanamine)-1H-benzimidazole, min. 98% (R)-i-Bu-BIMAH (1235960-36-7)	100mg	See page 190
07-1245	(S)-(-)-2-(α -(t-butyl)methanamine)-1H-benzimidazole, min. 95% (S)-t-Bu-BIMAH (1118114-88-7)	100mg	See page 189

LIGAND KITS - Garphos™ Ligand Kit**96-4100 Garphos™ Ligand Kit**

Sold in collaboration with KCT. Patent US App No. 61/381,493.

Components also available for individual sale.

Contains the following:

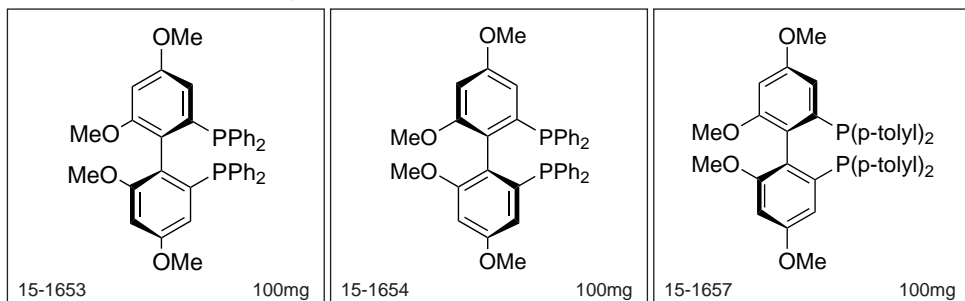

LIGAND KITS - Garphos™ Ligand Kit

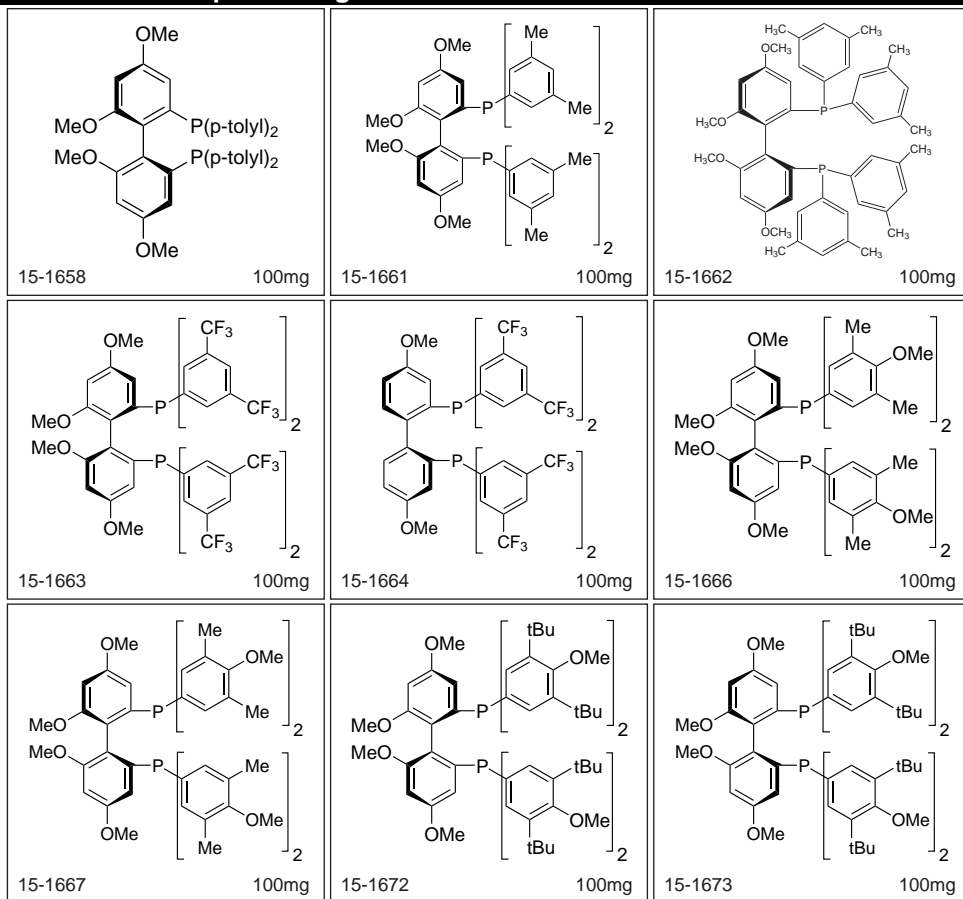

15-1653	(R)-2,2'-Bis(diphenylphosphino)-4,4',6,6'-tetramethoxy-1,1'-biphenyl, min. 97% (R)-Ph-Garphos™ (1365531-75-4)	100mg	See page 272
15-1654	(S)-2,2'-Bis(diphenylphosphino)-4,4',6,6'-tetramethoxy-1,1'-biphenyl, min. 97% (S)-Ph-Garphos™ (1365531-76-5)	100mg	See page 272
15-1657	(R)-2,2'-Bis(di-p-tolylphosphino)-4,4',6,6'-tetramethoxy-1,1'-biphenyl, min. 97% (R)-Tol-Garphos™ (1365531-81-2)	100mg	See page 275
15-1658	(S)-2,2'-Bis(di-p-tolylphosphino)-4,4',6,6'-tetramethoxy-1,1'-biphenyl, min. 97% (S)-Tol-Garphos™ (1365531-82-3)	100mg	See page 275
15-1661	(R)-2,2'-Bis[bis(3,5-dimethylphenyl)phosphino]-4,4',6,6'-tetramethoxy-1,1'-biphenyl, min. 97% (R)-Xyl-Garphos™ (1365531-89-0)	100mg	See page 253
15-1662	(S)-2,2'-Bis[bis(3,5-dimethylphenyl)phosphino]-4,4',6,6'-tetramethoxy-1,1'-biphenyl, min. 97% (S)-Xyl-Garphos™ (1365531-90-3)	100mg	See page 253
15-1663	(R)-2,2'-Bis[bis(3,5-trifluoromethylphenyl)phosphino]-4,4',6,6'-tetramethoxy-1,1'-biphenyl, min. 97% (R)-BTFM-Garphos™ (1365531-84-5)	100mg	See page 255
15-1664	(S)-2,2'-Bis[bis(3,5-trifluoromethylphenyl)phosphino]-4,4',6,6'-tetramethoxy-1,1'-biphenyl, min. 97% (S)-BTFM-Garphos™ (1365531-85-6)	100mg	See page 255
15-1666	(R)-2,2'-Bis[bis(4-methoxy-3,5-dimethylphenyl)phosphino]-4,4',6,6'-tetramethoxy-1,1'-biphenyl, min. 97% (R)-DMM-Garphos™ (1365531-93-6)	100mg	See page 254
15-1667	(S)-2,2'-Bis[bis(4-methoxy-3,5-dimethylphenyl)phosphino]-4,4',6,6'-tetramethoxy-1,1'-biphenyl, min. 97% (S)-DMM-Garphos™ (1365531-94-7)	100mg	See page 254
15-1672	(R)-2,2'-Bis[bis(4-methoxy-3,5-di-t-butylphenyl)phosphino]-4,4',6,6'-tetramethoxy-1,1'-biphenyl, min. 97% (R)-DTBM-Garphos™ (1365531-98-1)	100mg	See page 253
15-1673	(S)-2,2'-Bis[bis(4-methoxy-3,5-di-t-butylphenyl)phosphino]-4,4',6,6'-tetramethoxy-1,1'-biphenyl, min. 97% (S)-DTBM-Garphos™ (1365531-99-2)	100mg	See page 253

LIGAND KITS - NHC Ligand Kit 1: Chiral N-Heterocyclic Carbenes**96-3760 NHC Ligand Kit 1: Chiral N-Heterocyclic Carbenes**

Sold under license from Kanata for research purposes only. WO2010/003226.

Components also available for individual sale.

Contains the following:

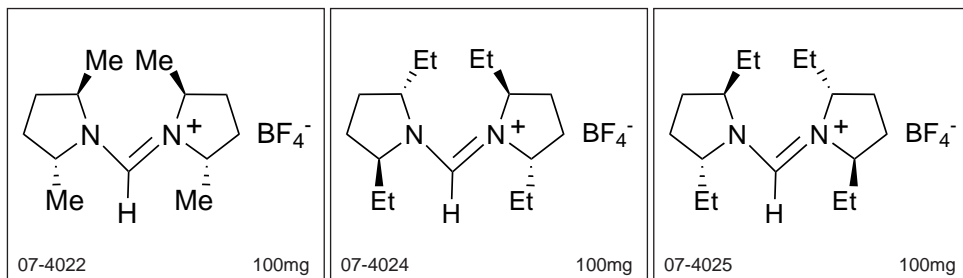

07-4022	(2R,5R)-1-((2R,5R)-2,5-Dimethylpyrrolidin-1-yl)methylene)-2,5-dimethylpyrrolidinium tetrafluoroborate, min. 97% (1204324-14-0)	100mg	See page 198
07-4024	(2R,5R)-1-(((2R,5R)-2,5-Diethylpyrrolidin-1-yl)methylene)-2,5-diethylpyrrolidinium tetrafluoroborate, min. 97% (1204324-20-8)	100mg	See page 196
07-4025	(2S,5S)-1-(((2S,5S)-2,5-Diethylpyrrolidin-1-yl)methylene)-2,5-diethylpyrrolidinium tetrafluoroborate, min. 97% (1204324-18-4)	100mg	See page 196

LIGAND KITS - NHC Ligand Kit 2: "Free" Carbenes**96-3765 NHC Ligand Kit 2: "Free" Carbenes**

HAZ

Components also available for individual sale.

Contains the following:

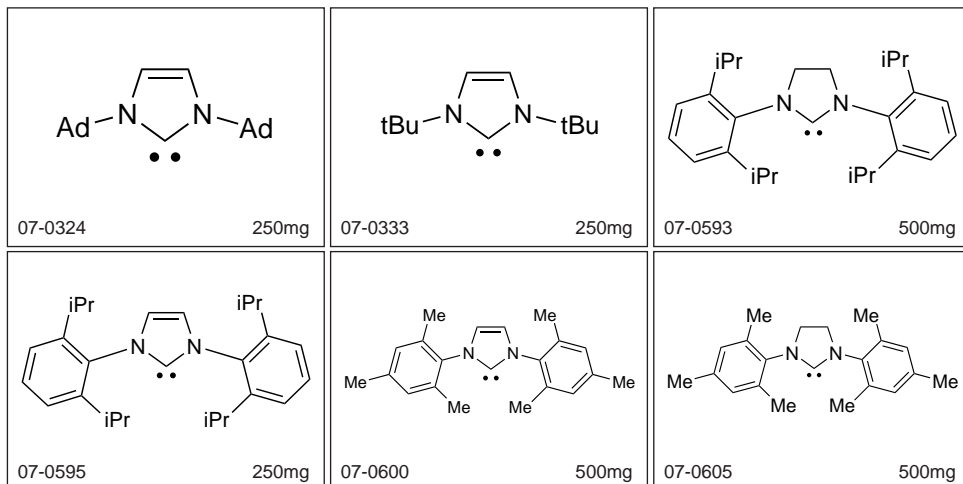

07-0324	1,3-Bis(1-adamantyl)imidazol-2-ylidene, min. 98% ARDUENGO'S CARBENE (131042-77-8)	250mg	See page 180
07-0333	1,3-Di-t-butylimidazol-2-ylidene, min. 98% (157197-53-0)	250mg	See page 195
07-0593	1,3-Bis(2,6-di-i-propylphenyl)-4,5-dihydroimidazol-2-ylidene, min. 98% (258278-28-3)	500mg	See page 183
07-0595	1,3-Bis(2,6-di-i-propylphenyl)imidazol-2-ylidene, min. 98% (244187-81-3)	250mg	See page 184
07-0600	1,3-Bis(2,4,6-trimethylphenyl)imidazol-2-ylidene, min. 98% (141556-42-5)	500mg	See page 189
07-0605	1,3-Bis(2,4,6-trimethylphenyl)-4,5-dihydroimidazol-2-ylidene, min. 98% (173035-11-5)	500mg	See page 189

LIGAND KITS - NHC Ligand Kit 3: Variety of N-Heterocyclic Carbenes

96-3770 NHC Ligand Kit 3: Variety of N-Heterocyclic Carbenes

Components also available for individual sale. Contains the following:

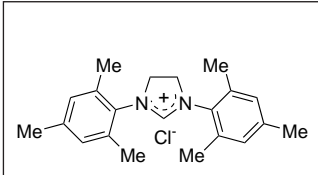
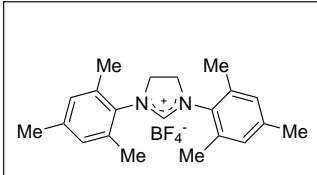
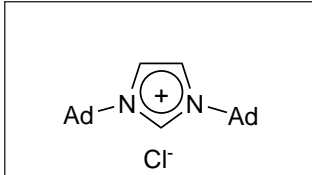
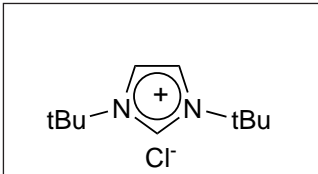
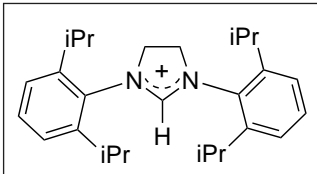
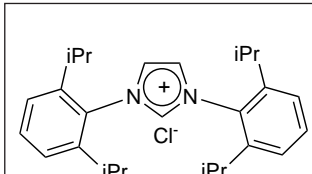
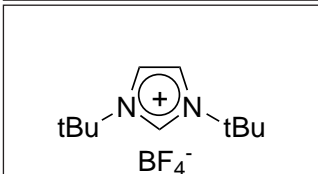
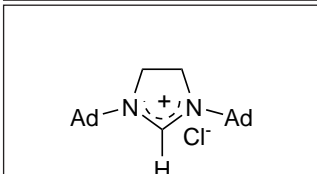
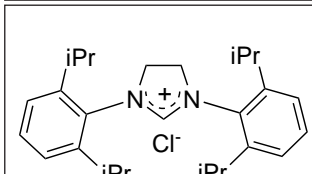
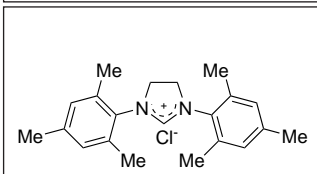
		
07-0299 1g	07-0302 1g	07-0322 250mg
		
07-0368 250mg	07-0587 1g	07-0590 500mg
		
07-0598 500mg	07-4007 500mg	07-4009 500mg
		
	07-4011 500mg	

07-0299	1,3-Bis(2,4,6-trimethylphenyl)imidazolium chloride, min. 97% (141556-45-8)	1g	See page 189
07-0302	1,3-Bis(2,4,6-trimethylphenyl)-4,5-dihydroimidazolium tetrafluoroborate, min. 95% SIMes-HBF ₄ (245679-18-9)	1g	See page 189
07-0322	1,3-Bis(1-adamantyl)imidazolium chloride, min. 97% (131042-78-9)	250mg	See page 180
07-0368	1,3-Di-tert-butylimidazolium chloride, min. 98% (157197-54-1)	250mg	See page 194
07-0587	1,3-Bis(2,6-di-i-propylphenyl)-4,5-dihydroimidazolium tetrafluoroborate, min. 95% (282109-83-5)	1g	See page 183
07-0590	1,3-Bis(2,6-di-i-propylphenyl)imidazolium chloride, min. 97% (250285-32-6)	500mg	See page 184
07-0598	1,3-Bis(tert-butyl)imidazolium tetrafluoroborate, min. 97% tBuHBF ₄ (263163-17-3)	500mg	See page 181
07-4007	1,3-Bis(1-adamantyl)-4,5-dihydroimidazolium chloride, min. 97% (871126-33-9)	500mg	See page 180
07-4009	1,3-Bis(2,6-di-i-propylphenyl)-4,5-dihydroimidazolium chloride, min. 97% (258278-25-0)	500mg	See page 183
07-4011	1,3-Bis(2,4,6-trimethylphenyl)-4,5-dihydroimidazolium chloride, min. 97% (173035-10-4)	500mg	See page 189

LIGAND KITS - NHC Ligand Kit 4: Bis Carbenes**96-3775 NHC Ligand Kit 4: Bis Carbenes**

Components also available for individual sale.

Contains the following:

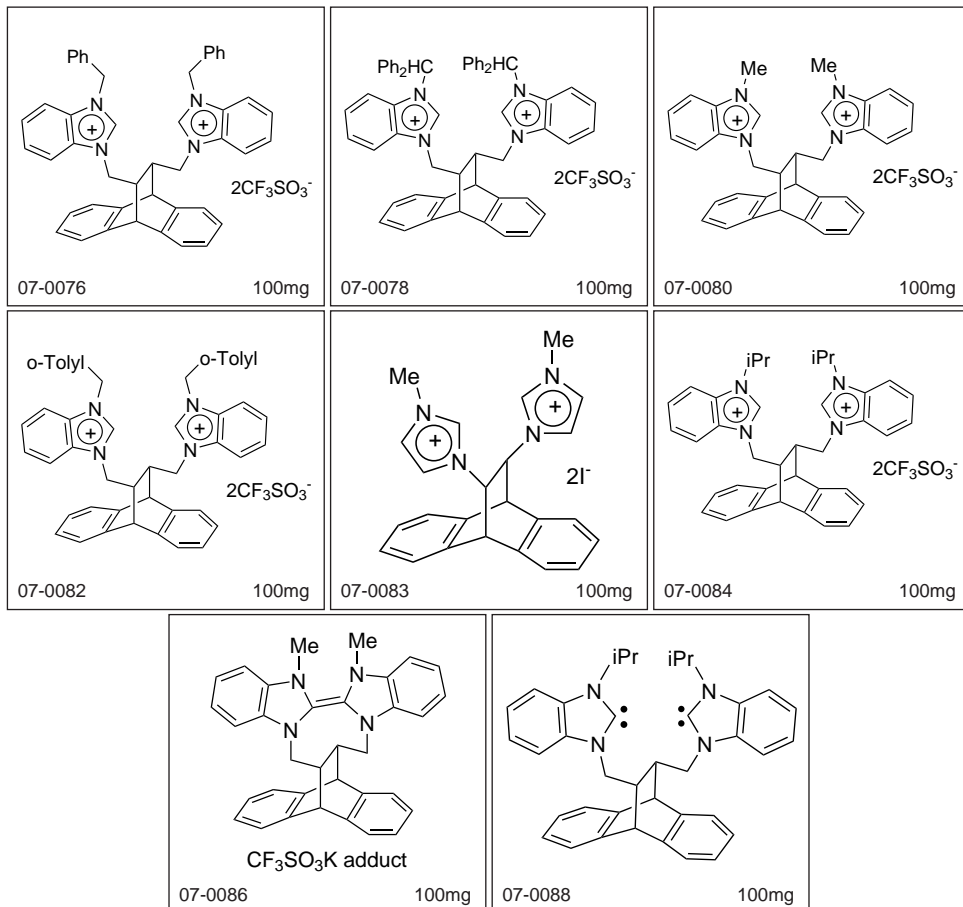

07-0076	11,12-Bis[N-benzyl-1H-imidazolium-3-methylene]-9,10-dihydro-9,10-ethanoanthracene bis(trifluoromethanesulfonate)	100mg	See page 180
07-0078	11,12-Bis[N-(2,2-diphenyl-1-ethyl)-1H-benzimidazolium-3-methylene]-9,10-dihydro-9,10-ethanoanthracene bis(trifluoromethanesulfonate), min. 95%	100mg	See page 183
07-0080	11,12-Bis[N-methyl-1H-benzimidazolium-3-methylene]-9,10-dihydro-9,10-ethanoanthracene bis(trifluoromethanesulfonate) (958004-03-0)	100mg	See page 186
07-0082	11,12-Bis[N-(2-methylbenzyl)-1H-benzimidazolium-3-methylene]-9,10-dihydro-9,10-ethanoanthracene bis(trifluoromethanesulfonate), min. 95%	100mg	See page 186
07-0083	11,12-Bis[3-methylimidazolium]-9,10-dihydro-9,10-ethanoanthracene bis(iodide), min. 95%	100mg	See page 186
07-0084	11,12-Bis[N-(i-propyl)-1H-benzimidazolium-3-methylene]-9,10-dihydro-9,10-ethanoanthracene bis(trifluoromethanesulfonate) (958004-12-1)	100mg	See page 188
07-0086	(12a,18a)-5,6,12,12a,13,18,18a,19-Octahydro-5,6-dimethyl-13,18[1',2']-benzenobisbenzimidazo [1,2-b:2',1'-d]benzo[i][2.5]benzodiazocine potassium triflate adduct (958004-04-1)	100mg	See page 204
07-0088	11,12-Bis[1,3-dihydro-3-(i-propyl)-2H-benzimidazol-2-ylidene-3-methylene]-9,10-dihydro-9,10-ethanoanthracene (958004-05-2)	100mg	See page 182

LIGAND KITS - PhenCar-Phos Ligand Kit**96-3780 PhenCar-Phos Ligand Kit**

Components also available for individual sale.

Contains the following:

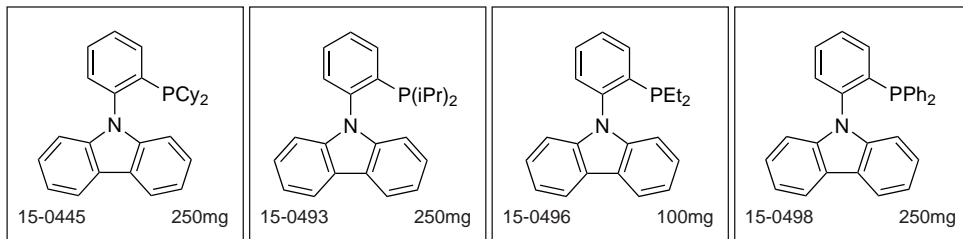

15-0445	9-[2-(Dicyclohexylphosphino)phenyl]-9H-carbazole, min. 98% PhenCar-Phos (1308652-64-3)	250mg	See page 294
15-0493	9-[2-(Diisopropylphosphino)phenyl]-9H-carbazole, min. 97% i-Pr PhenCar-Phos (1308652-65-4)	250mg	See page 310
15-0496	9-[2-(Diethylphosphino)phenyl]-9H-carbazole, min. 97% Et PhenCar-Phos (1308652-66-5)	100mg	See page 296
15-0498	9-[2-(Diphenylphosphino)phenyl]-9H-carbazole, min. 97% Ph PhenCar-Phos (1308652-67-6)	250mg	See page 307

LIGAND KITS - Phosphine Ligand Kit**96-1650 Phosphine Ligand Kit for Palladium-Catalyzed Carbon-Carbon and Carbon-Heteroatom Bond Formation**

For Palladium-catalyzed carbon-carbon and carbon-heteroatom bond formation.

Components also available for individual sale. Contains the following:

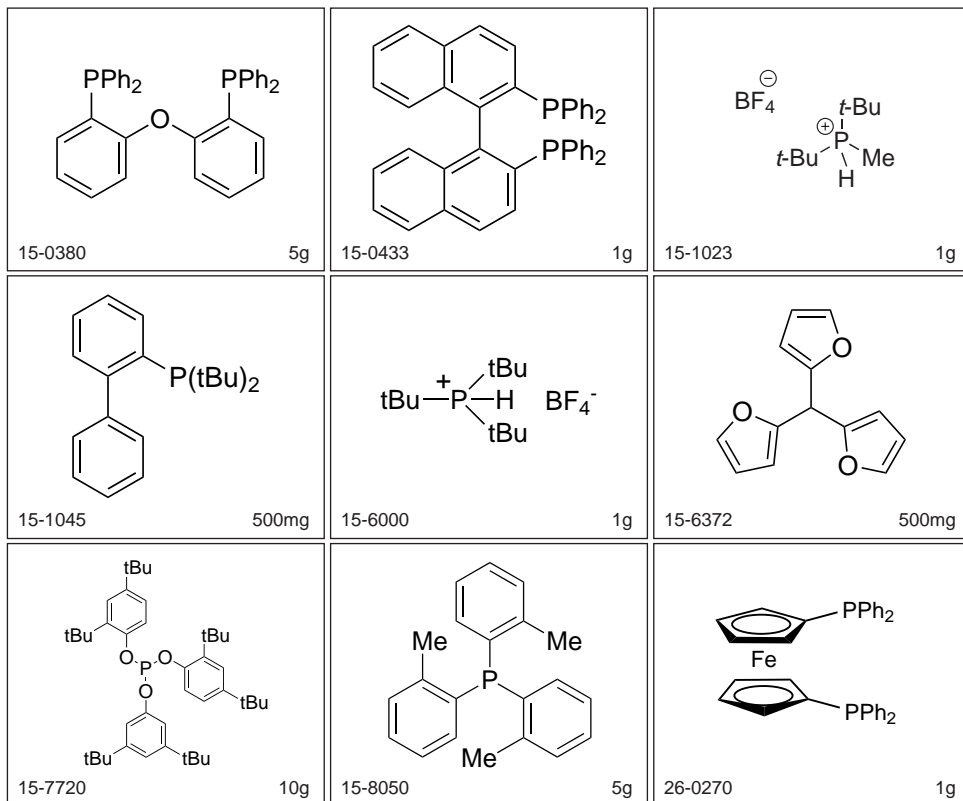

LIGAND KITS - Phosphine Ligand Kit

15-0380	Bis(2-diphenylphosphino)phenyl)ether, 98% DPEphos (166330-10-5)	5g	See page 270
15-0433	racemic-2,2'-Bis(diphenylphosphino)-1,1'-binaphthyl, 98% rac-BINAP (98327-87-8)	1g	See page 267
15-1023	Di-t-butylmethylphosphonium tetrafluoroborate, 99% (870777-30-3)	1g	See page 287
15-1045	2-(Di-t-butylphosphino)-1,1'-biphenyl, 99% JohnPhos (224311-51-7)	500mg	See page 288
15-6000	Tri-t-butylphosphonium tetrafluoroborate, 99% (131274-22-1)	1g	See page 326
15-6372	Tri-2-furylphosphine, 98+% (5518-52-5)	500mg	See page 327
15-7720	Tris(2,4-di-t-butylphenyl)phosphite, 98% (31570-04-4)	10g	See page 331
15-8050	Tri-o-tolylphosphine, 99% (6163-58-2)	5g	See page 333
26-0270	1,1'-Bis(diphenylphosphino)ferrocene, 99% DPPF (12150-46-8)	1g	See page 97

LIGAND KITS - PINAP Ligand Kit

96-7050

PINAP Ligand Kit

For a variety of asymmetric C-C bond formations.

Components also available for individual sale.

Contains the following:

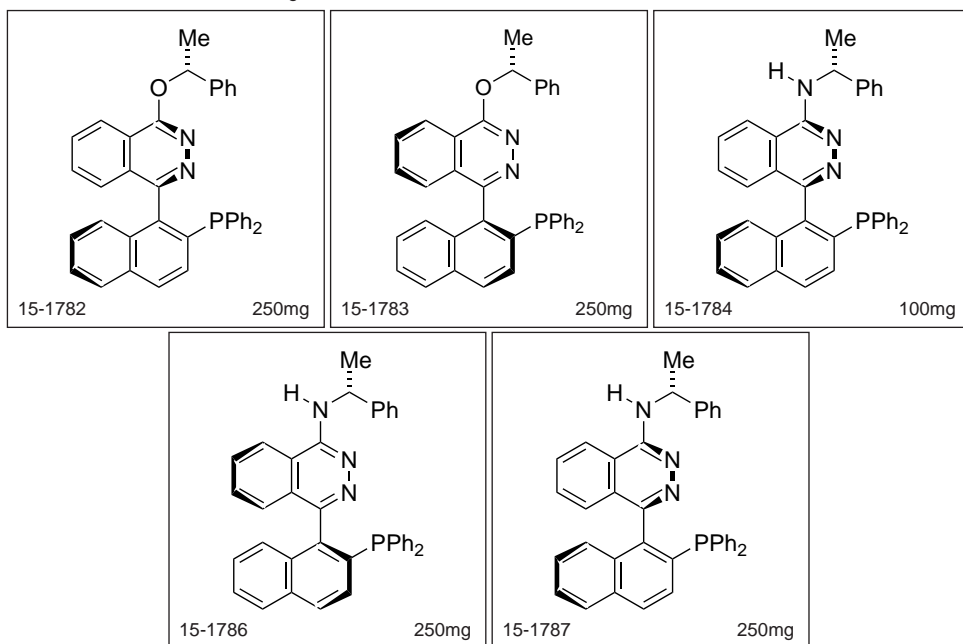

15-1782	(R)-(+)-4-[2-(Diphenylphosphino)-1-naphthalenyl]-N-[(R)-1-phenylethoxy]phthalazine, min. 97% (R,R)-O-PINAP (828927-95-3)	250mg	See page 307
15-1783	(S)-(-)-4-[2-(Diphenylphosphino)-1-naphthalenyl]-N-[(R)-1-phenylethoxy]phthalazine, min. 97% (R,S)-O-PINAP (828927-94-2)	250mg	See page 307
15-1784	(R)-(+)-4-[2-(Diphenylphosphino)-1-naphthalenyl]-N-[(R)-1-phenylethyl]-1-phthalazinamine, min. 97% (R,R)-N-PINAP (828927-97-5)	100mg	See page 307
15-1786	(S)-(-)-4-[2-(Diphenylphosphino)-1-naphthalenyl]-N-[(R)-1-phenylethyl]-1-phthalazinamine, min. 97% (R,S)-N-PINAP (828927-96-4)	250mg	See page 307
15-1787	(R)-(+)-4-[2-(Diphenylphosphino)-1-naphthalenyl]-N-[(S)-1-phenylethyl]-1-phthalazinamine, min. 97% (S,R)-N-PINAP (1173836-08-2)	250mg	See page 307

LIGAND KITS - SKP Ligand Kit**96-2310 SKP Ligand Kit for asymmetric-allylic amination and cyclopropanation**

Sold in collaboration with SIOC for research purposes only.

Patents PCT/CN2013/071091, CN202110253896.5

Components also available for individual sale.

Contains the following:

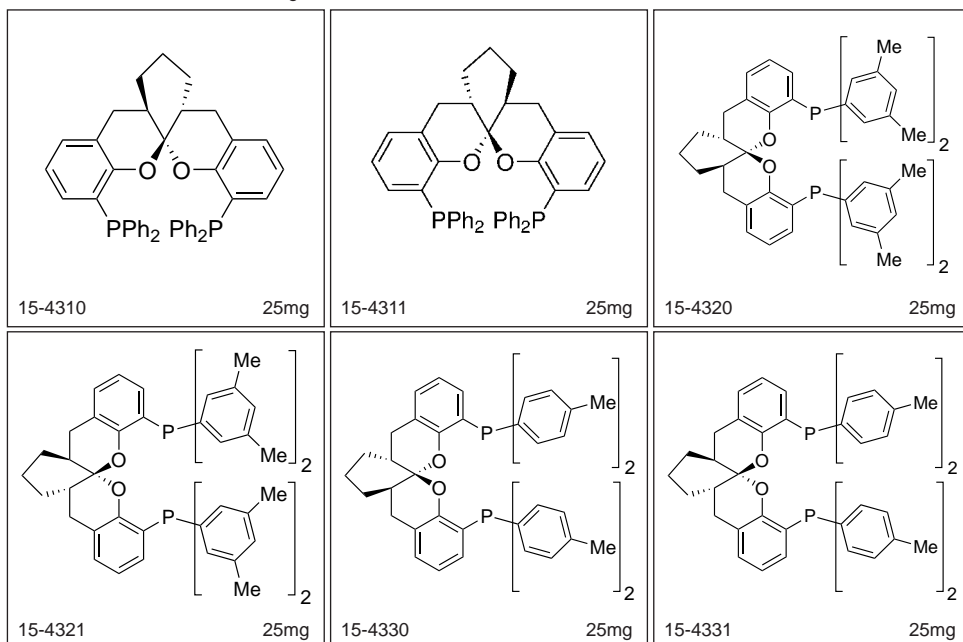

15-4310	(+)-1,13-Bis(diphenyl)phosphino-(5aR,8aR,14aR)-5a,6,7,8,8a,9-hexahydro-5H-[1]benzopyrano[3,2-d]xanthene, 97% (R,R,R)-(+)-Ph-SKP (1360823-43-3)	25mg	See page 269
15-4311	(-)-1,13-Bis(diphenyl)phosphino-(5aS,8aS,14aS)-5a,6,7,8,8a,9-hexahydro-5H-[1]benzopyrano[3,2-d]xanthene, 97% (S,S,S)-(-)-Ph-SKP (1439556-82-7)	25mg	See page 269
15-4320	(+)-1,13-Bis[di(3,5-dimethylphenyl)phosphino]-(5aR,8aR,14aR)-5a,6,7,8,8a,9-hexahydro-5H-[1]benzopyrano[3,2-d]xanthene, 97% (R,R,R)-(+)-Xyl-SKP (1429939-35-4)	25mg	See page 260
15-4321	(-)-1,13-Bis[di(3,5-dimethylphenyl)phosphino]-(5aS,8aS,14aS)-5a,6,7,8,8a,9-hexahydro-5H-[1]benzopyrano[3,2-d]xanthene, 97% (S,S,S)-(-)-Xyl-SKP (1429939-31-0)	25mg	See page 261
15-4330	(+)-1,13-Bis[di(4-methylphenyl)phosphino]-(5aR,8aR,14aR)-5a,6,7,8,8a,9-hexahydro-5H-[1]benzopyrano[3,2-d]xanthene, 97% (R,R,R)-(+)-Tol-SKP (1429939-32-1)	25mg	See page 264
15-4331	(-)-1,13-Bis[di(4-methylphenyl)phosphino]-(5aS,8aS,14aS)-5a,6,7,8,8a,9-hexahydro-5H-[1]benzopyrano[3,2-d]xanthene, 97% (S,S,S)-(-)-Tol-SKP (1548897-80-8)	25mg	See page 264

LIGAND KITS - Solvias CataCXium® Ligand Kit

96-6651

Solvias cataCXium® Ligand Kit for C-X coupling reactions

For C-X coupling reactions. Sold in collaboration with Solvias for research purposes only.

Components also available for individual sale. Contains the following:

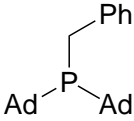
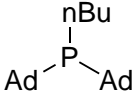
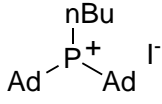
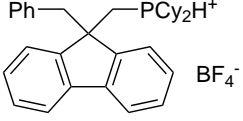
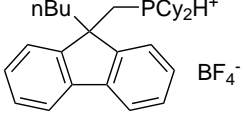
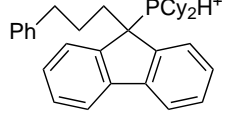
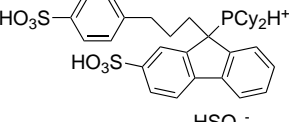
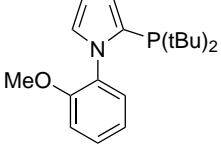
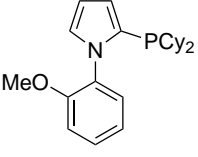
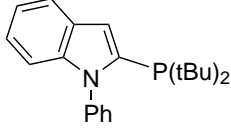
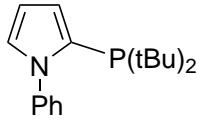
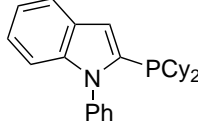
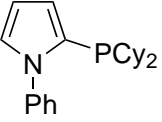
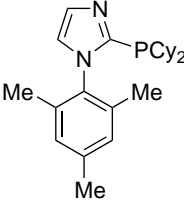
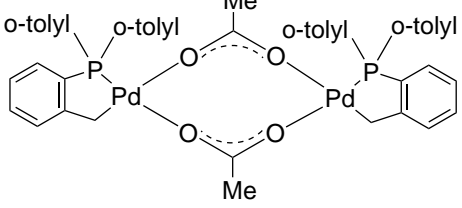
 <p>15-0038 500mg</p>	 <p>15-0483 1g</p>	 <p>15-0495 250mg</p>
 <p>15-1072 500mg</p>	 <p>15-1074 500mg</p>	 <p>15-1076 500mg</p>
 <p>15-1078 500mg</p>	 <p>15-2975 500mg</p>	 <p>15-2980 500mg</p>
 <p>15-3550 500mg</p>	 <p>15-3600 500mg</p>	 <p>15-3605 500mg</p>
 <p>15-3610 500mg</p>	 <p>15-6362 500mg</p>	 <p>46-0290 250mg</p>

LIGAND KITS - Solvias CataCXium® Ligand Kit

15-0038	Benzyl-di-1-adamantylphosphine, min. 85% [cataCXium® ABn] (395116-70-8)	500mg	See page 251
15-0483	Butyl-di-1-adamantylphosphine, min. 95% [cataCXium® A] (321921-71-5)	1g	See page 282
15-0495	n-Butyl-di-(1-adamantyl)phosphonium iodide, min. 95% [cataCXium® AHI] (714951-87-8)	250mg	See page 282
15-1072	Dicyclohexyl(9-benzylfluoren-9-yl)phosphonium tetrafluoroborate, min. 97% [cataCXium® FBn] (937378-18-2)	500mg	See page 291
15-1074	Dicyclohexyl(9-butylfluoren-9-yl)phosphonium tetrafluoroborate, min. 95% [cataCXium® FBu] (1007311-98-9)	500mg	See page 291
15-1076	Dicyclohexyl[9-(3-phenylpropyl)fluoren-9-yl]phosphonium tetrafluoroborate, min. 95% [cataCXium® FPrPh] (1007311-95-6)	500mg	See page 292
15-1078	Dicyclohexyl-{9-[3-(4-sulfonylphenyl)propyl]-2-sulfonylfluoren-9-yl} phosphonium hydrogen sulfate, min. 95% [cataCXium® FSulf]	500mg	See page 295
15-2975	N-(2-Methoxyphenyl)-2-(di-t-butylphosphino)pyrrole, min. 95% [cataCXium® POMetB] (1053658-91-5)	500mg	See page 315
15-2980	1-(2-Methoxyphenyl)-2-(dicyclohexylphosphino)pyrrole, min. 95% [cataCXium® POMeCy] (672937-63-2)	500mg	See page 315
15-3550	N-Phenyl-2-(di-t-butylphosphino)indol, min. 98% [cataCXium® PIntB] (740815-37-6)	500mg	See page 318
15-3600	N-Phenyl-2-(di-t-butylphosphino)pyrrole, 95+% [cataCXium® PtB] (672937-61-0)	500mg	See page 318
15-3605	N-Phenyl-2-(dicyclohexylphosphino)indol, min. 95% [cataCXium® PInCy] (740815-36-5)	500mg	See page 318
15-3610	N-Phenyl-2-(dicyclohexylphosphino)pyrrole, 90% [cataCXium® PCy] (672937-60-9)	500mg	See page 318
15-6362	1-(2,4,6-Trimethylphenyl)-2-(dicyclohexylphosphino)imidazole, min. 95% [cataCXium® PICy] (794527-14-3)	500mg	See page 328
46-0290	trans-Di(μ-acetato)bis[o-(di-o-tolylphosphino)benzyl]dipalladium(II), 97+% [cataCXium® C] (172418-32-5)	250mg	See page 235

LIGAND KITS - Solvias Josiphos Ligand Kit**96-3650 Solvias Josiphos Ligand Kit**

For asymmetric catalytic hydrogenations and other transformations.

Sold in collaboration with Solvias for research purposes only.

Components also available for individual sale.

Contains the following:

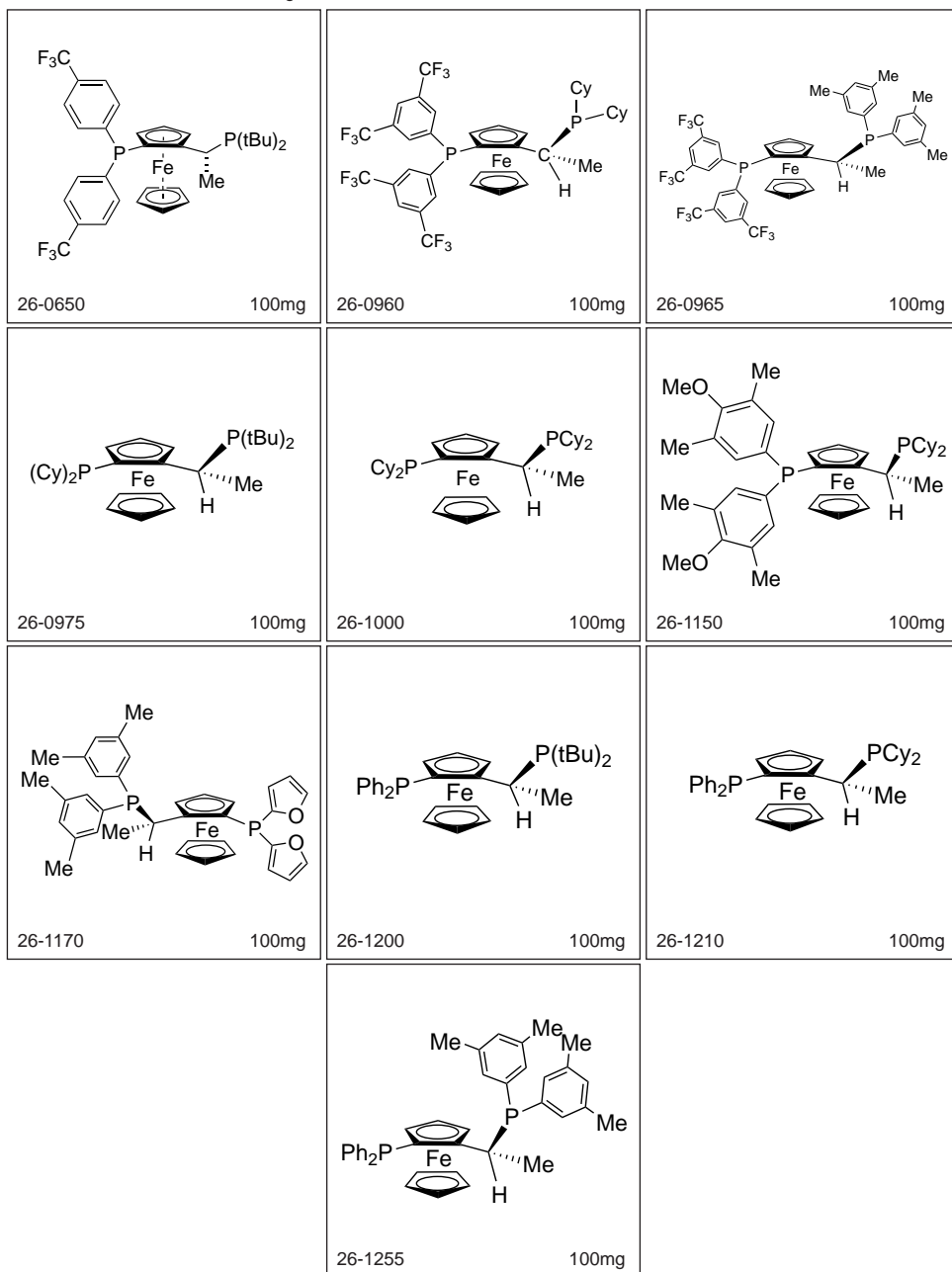

LIGAND KITS - Solvias Josiphos Ligand Kit

26-0650	(R)-(-)-1-((S)-2-[Bis(4-trifluoromethylphenyl) phosphino]ferrocenyl) ethyl-di-t-butylphosphine, min. 97% (246231-79-8)	100mg	See page 99
26-0960	(R)-(-)-1-((S)-2-[Bis(3,5-di-trifluoromethylphenyl)phosphino]ferrocenyl) ethyldicyclohexylphosphine, min. 97% (292638-88-1)	100mg	See page 98
26-0965	(R)-(-)-1-((S)-2-[Bis(3,5-di-trifluoromethylphenyl)phosphino]ferrocenyl) ethyldi-3,5-xylylphosphine, min. 97% (166172-63-0)	100mg	See page 98
26-0975	(R)-(-)-1-((S)-2-(Dicyclohexylphosphino)ferrocenyl)ethyldi-t-butylphosphine, min. 97% (158923-11-6)	100mg	See page 101
26-1000	(R)-(-)-1-((S)-2-(Dicyclohexylphosphino) ferrocenyl)ethyldicyclohexylphosphine, min. 97% (167416-28-6)	100mg	See page 101
26-1150	(R)-(-)-1-((S)-2-[Bis(3,5-dimethyl-4-methoxyphenyl)phosphino] ferrocenyl)ethyldicyclohexylphosphine, min. 97% (360048-63-1)	100mg	See page 97
26-1170	(S)-(+)-1-((R)-2-(Di-2-furylphosphino)ferrocenyl)ethyldi-3,5-xylylphosphine, min. 97% (649559-66-0)	100mg	See page 102
26-1200	(R)-(-)-1-((S)-2-(Diphenylphosphino)ferrocenyl)ethyldi-t-butylphosphine, min. 97% (155830-69-6)	100mg	See page 103
26-1210	(R)-(-)-1-((S)-2-(Diphenylphosphino) ferrocenyl)ethyldicyclohexylphosphine ethanol adduct, min. 97% (R)-(S)-JOSIPHOS (155806-35-2)	100mg	See page 104
26-1255	(R)-(-)-1-((S)-2-(Diphenylphosphino) ferrocenyl)ethyldi-3,5-xylylphosphine, min. 97% (184095-69-0)	100mg	See page 104

LIGAND KITS - Solvias MandyPhos™ Ligand Kit**96-3652 Solvias MandyPhos™ Ligand Kit**

For asymmetric catalytic hydrogenations and other transformations.

Sold in collaboration with Solvias for research purposes only.

Components also available for individual sale.

Contains the following:

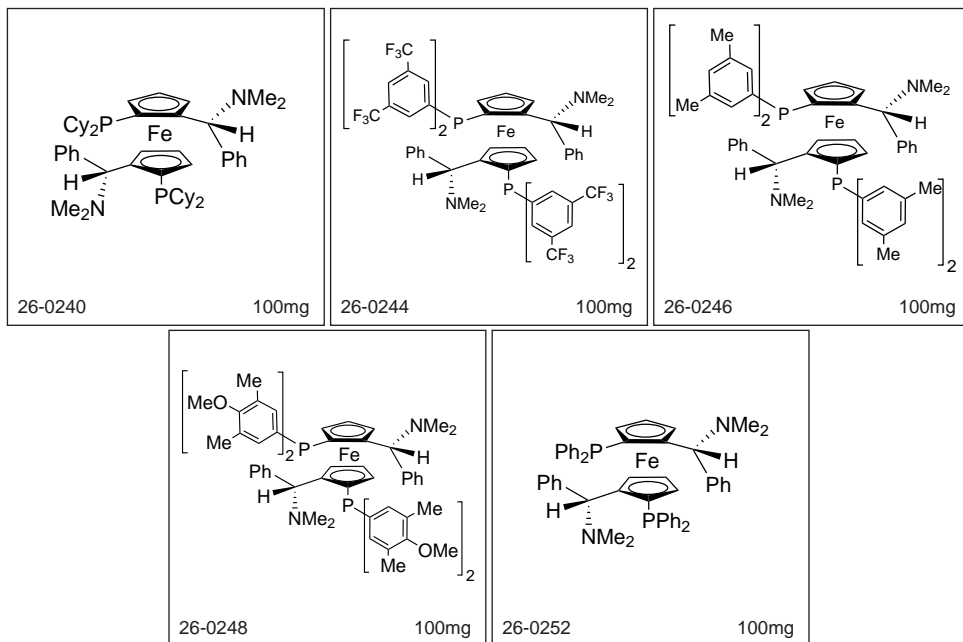

LIGAND KITS - Solvias MandyPhos™ Ligand Kit

26-0240	(S,S)-(+)-2,2'-Bis[(R)-(N,N-dimethylamino)(phenyl)methyl]-1,1'-bis(dicyclohexylphosphino)ferrocene, min. 97% (494227-35-9)	100mg	See page 96
26-0244	(S,S)-(-)-2,2'-Bis[(R)-(N,N-dimethylamino)(phenyl)methyl]-1,1'-bis[di(3,5-trifluoromethylphenyl)phosphino]ferrocene, min. 97% (494227-36-0)	100mg	See page 97
26-0246	(S,S)-(-)-2,2'-Bis[(R)-(N,N-dimethylamino)(phenyl)methyl]-1,1'-bis(di(3,5-dimethylphenyl)phosphino)ferrocene, min. 97% (793718-16-8)	100mg	See page 96
26-0248	(S,S)-(-)-2,2'-Bis[(R)-(N,N-dimethylamino)(phenyl)methyl]-1,1'-bis[di(3,5-dimethyl-4-methoxyphenyl)phosphino]ferrocene, min. 97% (494227-37-1)	100mg	See page 96
26-0252	(S,S)-(-)-2,2'-Bis[(R)-(N,N-dimethylamino)(phenyl)methyl]-1,1'-bis(diphenylphosphino)ferrocene, min. 97% (174467-31-3)	100mg	See page 96

LIGAND KITS - Solvias Walphos Ligand Kit**96-3651 Solvias Walphos Ligand Kit**

For asymmetric catalytic hydrogenations and other transformations. Sold in collaboration with Solvias for research purposes only. Components also available for individual sale. Contains the following:

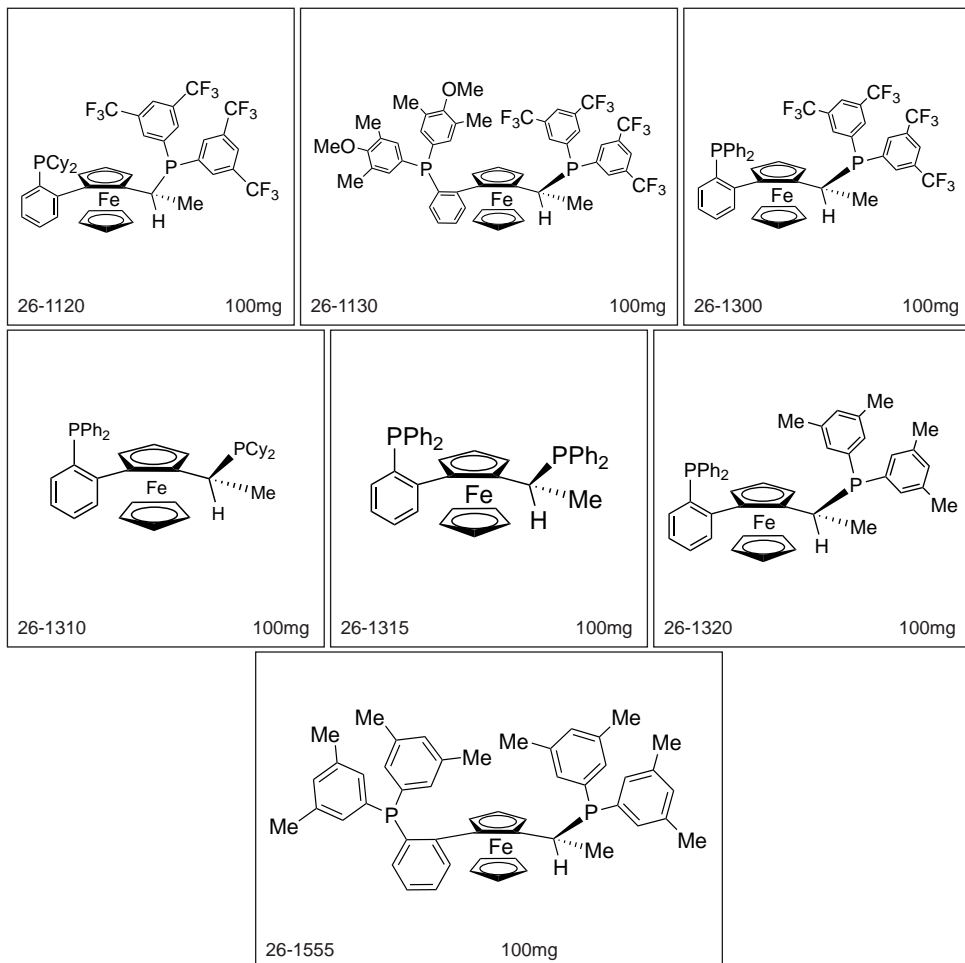

LIGAND KITS - Solvias Walphos Ligand Kit

26-1120	(R)-(+)-1-[(R)-2-(2'-Dicyclohexylphosphinophenyl)ferrocenyl]ethylbis(3,5-trifluoromethylphenyl)phosphine, min. 97% (821009-34-1)	100mg	See page 102
26-1130	(R)-(+)-1-[(R)-2-[2'-Bis(3,5-dimethyl-4-methoxyphenyl)phosphinophenyl]ferrocenyl] ethylbis(di-3,5-tri fluoromethylphenyl) phosphine, min. 97% (494227-30-4)	100mg	See page 97
26-1300	(R)-(-)-1-[(R)-2-(2'-Diphenylphosphinophenyl)ferrocenyl]ethylbis(di-3,5-trifluoromethylphenyl)phosphine, min. 97% (565184-33-0)	100mg	See page 104
26-1310	(R)-(-)-1-[(R)-2-(2'-Diphenylphosphinophenyl)ferrocenyl] ethyldicyclohexylphosphine, min. 97% (565184-29-4)	100mg	See page 104
26-1315	(R)-(+)-1-[(R)-2-(2'-Diphenylphosphinophenyl)ferrocenyl]ethyl-di-phenylphosphine, min. 97% (565184-32-9)	100mg	See page 104
26-1320	(R)-(+)-1-[(R)-2-(2'-Diphenylphosphinophenyl)ferrocenyl]ethyl-di(3,5-xylyl)phosphine, min. 97% (894771-25-6)	100mg	See page 105
26-1555	(R)-(+)-1-[(R)-2-(2'-Di-3,5-xylylphosphinophenyl)ferrocenyl]ethyl-di-3,5-xylylphosphine, min. 97% (894771-28-9)	100mg	See page 105

LIGAND KITS - Solvias (R)-MeO-BIPHEP Ligand Kit**96-3655 Solvias (R)-MeO-BIPHEP Ligand Kit**

Sold in collaboration with Solvias for research purposes only.
Components also available for individual sale.
Contains the following:

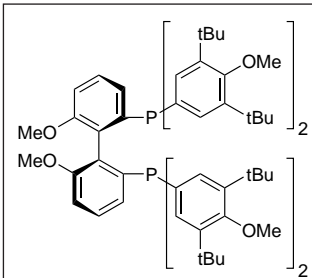
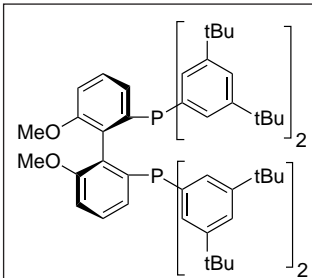
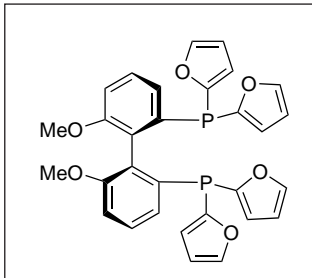
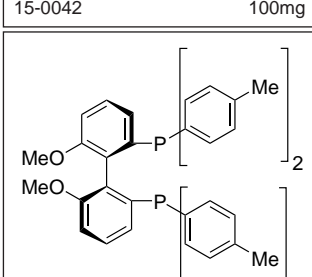
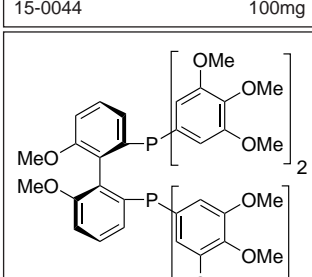
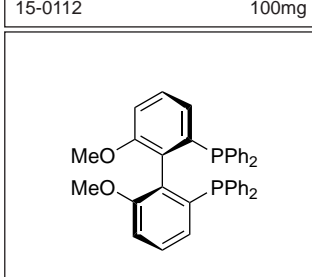
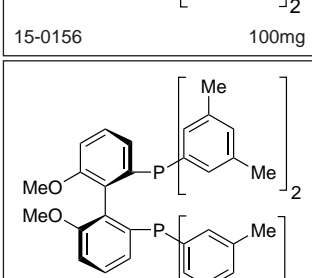
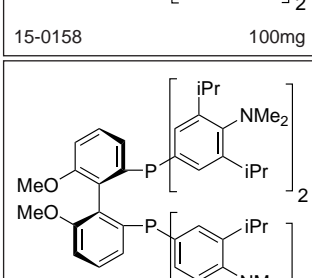
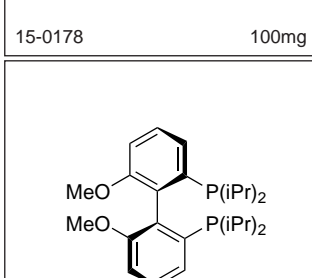
	15-0042	100mg		15-0044	100mg		15-0112	100mg
	15-0156	100mg		15-0158	100mg		15-0178	100mg
	15-0488	100mg		15-0652	100mg		15-0654	100mg

LIGAND KITS - Solvias (R)-MeO-BIPHEP Ligand Kit

15-0042	(R)-(-)-2,2'-Bis[di(3,5-di- <i>t</i> -butyl-4-methoxyphenyl)phosphino]-6,6'-dimethoxy-1,1'-biphenyl, min. 97% (352655-61-9)	100mg	See page 260
15-0044	(R)-(+)-2,2'-Bis[di(3,5-di- <i>t</i> -butylphenyl)phosphino]-6,6'-dimethoxy-1,1'-biphenyl, min. 97% (192138-05-9)	100mg	See page 260
15-0112	(R)-(+)-2,2'-Bis(di-2-furanylphosphino)-6,6'-dimethoxy-1,1'-biphenyl, min. 97% (145214-57-9)	100mg	See page 262
15-0156	(R)-(+)-2,2'-Bis(di- <i>p</i> -tolylphosphino)-6,6'-dimethoxy-1,1'-biphenyl, min. 97% (133545-24-1)	100mg	See page 275
15-0158	(R)-(+)-2,2'-Bis[di(3,4,5-trimethoxyphenyl)phosphino]-6,6'-dimethoxy-1,1'-biphenyl, min. 97% (256390-47-3)	100mg	See page 276
15-0178	(R)-(+)-2,2'-Bis(diphenylphosphino)-6,6'-dimethoxy-1,1'-biphenyl, min. 97% (R)-MeO-BIPHEP (133545-16-1)	100mg	See page 268
15-0488	(R)-(+)-2,2'-Bis[di(3,5-xylyl)phosphino]-6,6'-dimethoxy-1,1'-biphenyl, min. 97% (394248-45-4)	100mg	See page 277
15-0652	(R)-(-)-2,2'-Bis[di(3,5-di- <i>i</i> -propyl-4-dimethylaminophenyl)phosphino]-6,6'-dimethoxy-1,1'-biphenyl, min. 97% (352655-40-4)	100mg	See page 261
15-0654	(R)-(+)-2,2'-Bis(di- <i>i</i> -propylphosphino)-6,6'-dimethoxy-1,1'-biphenyl, min. 97% (150971-45-2)	100mg	See page 273

LIGAND KITS - Solvias (S)-MeO-BIPHEP Ligand Kit

96-3656

Solvias (S)-MeO-BIPHEP Ligand Kit

Sold in collaboration with Solvias for research purposes only.

Components also available for individual sale.

Contains the following:

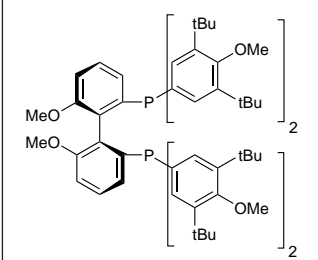
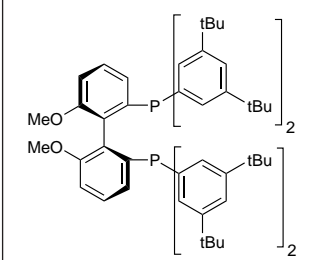
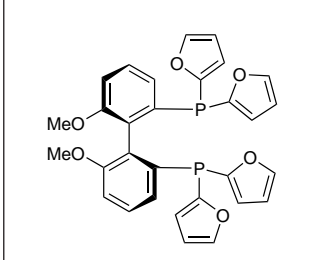
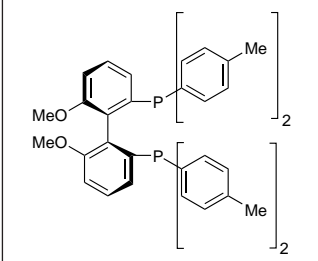
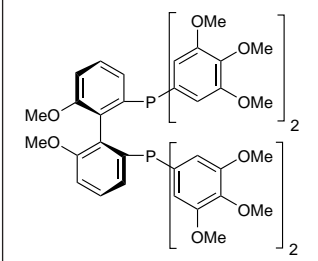
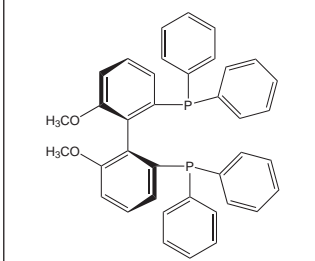
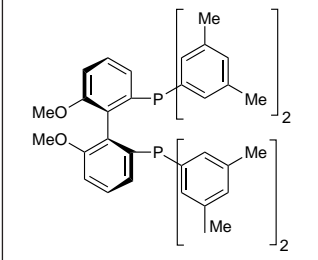
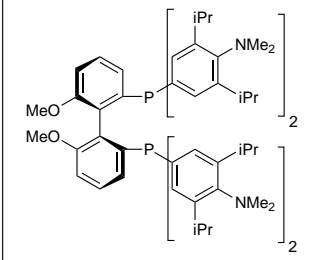
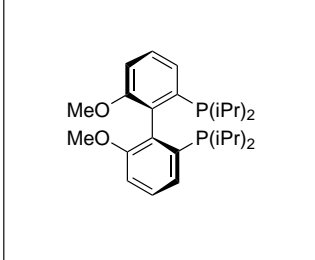
	15-0043	100mg		15-0045	100mg		15-0113	100mg
	15-0157	100mg		15-0159	100mg		15-0179	100mg
	15-0489	100mg		15-0653	100mg		15-0655	100mg

LIGAND KITS - Solvias (S)-MeO-BIPHEP Ligand Kit

15-0043	(S)-(+)-2,2'-Bis[di(3,5-di-t-butyl-4-methoxyphenyl)phosphino]-6,6'-dimethoxy-1,1'-biphenyl, min. 97% (910134-30-4)	100mg	See page 260
15-0045	(S)-(-)-2,2'-Bis[di(3,5-di-t-butylphenyl)phosphino]-6,6'-dimethoxy-1,1'-biphenyl, min. 97% (167709-31-1)	100mg	See page 260
15-0113	(S)-(-)-2,2'-Bis(di-2-furanylphosphino)-6,6'-dimethoxy-1,1'-biphenyl, min. 97% (145214-59-1)	100mg	See page 262
15-0157	(S)-(-)-2,2'-Bis(di-p-tolylphosphino)-6,6'-dimethoxy-1,1'-biphenyl, min. 97% (133545-25-2)	100mg	See page 275
15-0159	(S)-(-)-2,2'-Bis[di(3,4,5-trimethoxyphenyl)phosphino]-6,6'-dimethoxy-1,1'-biphenyl, min. 97% (256235-61-7)	100mg	See page 276
15-0179	(S)-(-)-2,2'-Bis(diphenylphosphino)-6,6'-dimethoxy-1,1'-biphenyl, min. 97% (S)-MeO-BIPHEP (133545-17-2)	100mg	See page 268
15-0489	(S)-(-)-2,2'-Bis[di(3,5-xylyl)phosphino]-6,6'-dimethoxy-1,1'-biphenyl, min. 97% (362634-22-8)	100mg	See page 277
15-0653	(S)-(+)-2,2'-Bis[di(3,5-di-i-propyl-4-dimethylaminophenyl)phosphino]-6,6'-dimethoxy-1,1'-biphenyl, min. 97% (919338-66-2)	100mg	See page 261
15-0655	(S)-(-)-2,2'-Bis(di-i-propylphosphino)-6,6'-dimethoxy-1,1'-biphenyl, min. 97% (150971-43-0)	100mg	See page 273

LIGAND KITS - Spiro Bisphosphine Ligand Kit

96-0060

Spiro Bisphosphine Ligand Kit

Components also available for individual sale.

Contains the following:

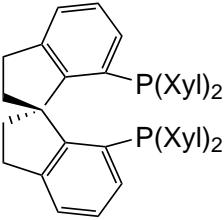
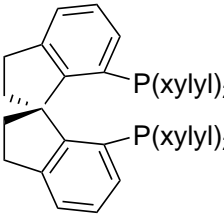
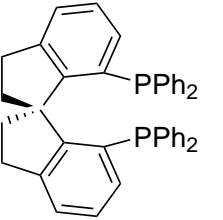
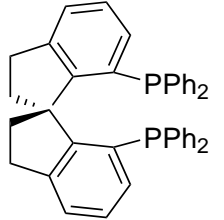
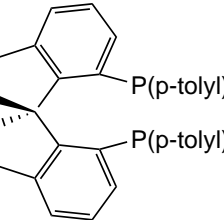
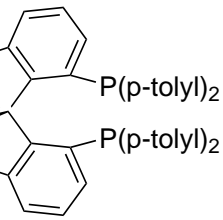
	15-5168	25mg
	15-5169	25mg
	15-5174	25mg
	15-5175	25mg
	15-5180	25mg
	15-5181	25mg

15-5168	(R)-(+)-7,7'-Bis[di(3,5-dimethylphenyl)phosphino]-2,2',3,3'-tetrahydro-1,1'-spirobiindane, min. 97% (R)-Xyl-SDP (917377-75-4)	25mg	See page 261
15-5169	(S)-(-)-7,7'-Bis[di(3,5-dimethylphenyl)phosphino]-2,2',3,3'-tetrahydro-1,1'-spirobiindane, min. 97% (S)-Xyl-SDP (528521-89-3)	25mg	See page 261
15-5174	(R)-(+)-7,7'-Bis(diphenylphosphino)-2,2',3,3'-tetrahydro-1,1'-spirobiindane, min. 97% (R)-SDP (917377-74-3)	25mg	See page 272
15-5175	(S)-(-)-7,7'-Bis(diphenylphosphino)-2,2',3,3'-tetrahydro-1,1'-spirobiindane, min. 97% (S)-SDP (528521-86-0)	25mg	See page 272
15-5180	(R)-(+)-7,7'-Bis[di(4-methylphenyl)phosphino]-2,2',3,3'-tetrahydro-1,1'-spirobiindane, min. 97% (R)-Tol-SDP (528521-87-1)	25mg	See page 264
15-5181	(S)-(-)-7,7'-Bis[di(4-methylphenyl)phosphino]-2,2',3,3'-tetrahydro-1,1'-spirobiindane, min. 97% (S)-Tol-SDP (817176-80-0)	25mg	See page 265

LIGAND KITS - Spiro Monophosphite & Monophosphoramidite Ligand Kit**96-0065 Spiro Monophosphite and Monophosphoramidite Ligand Kit**

Components also available for individual sale.

Contains the following:

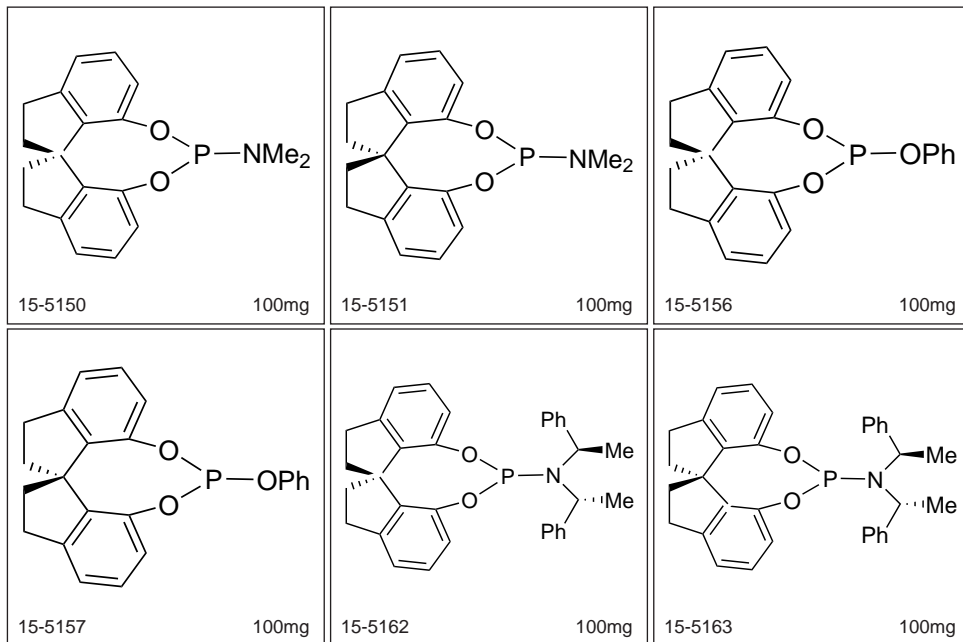

15-5150	(11aR)-(+)-10,11,12,13-Tetrahydrodiindeno[7,1-de:1',7'-fg][1,3,2]dioxaphosphocin-5-dimethylamine, min. 98% (R)-SIPHOS (443965-14-8)	100mg	See page 321
15-5151	(11aS)-(-)-10,11,12,13-Tetrahydrodiindeno[7,1-de:1',7'-fg][1,3,2]dioxaphosphocin-5-dimethylamine, min. 98% (S)-SIPHOS (443965-10-4)	100mg	See page 321
15-5156	(11aR)-(+)-10,11,12,13-Tetrahydrodiindeno[7,1-de:1',7'-fg][1,3,2]dioxaphosphocin-5-phenoxy, min. 98% (R)-ShiP (656233-53-3)	100mg	See page 322
15-5157	(11aS)-(-)-10,11,12,13-Tetrahydrodiindeno[7,1-de:1',7'-fg][1,3,2]dioxaphosphocin-5-phenoxy, min. 98% (S)-ShiP (885701-71-3)	100mg	See page 322
15-5162	(11aR)-(+)-10,11,12,13-Tetrahydrodiindeno[7,1-de:1',7'-fg][1,3,2]dioxaphosphocin-5-bis[(R)-1-phenylethyl]amine, min. 98% (R)-SIPHOS-PE (500997-69-3)	100mg	See page 321
15-5163	(11aS)-(-)-10,11,12,13-Tetrahydrodiindeno[7,1-de:1',7'-fg][1,3,2]dioxaphosphocin-5-bis[(R)-1-phenylethyl]amine, min. 98% (S)-SIPHOS-PE (500997-70-6)	100mg	See page 321

LIGAND KITS - Takasago BINAP Ligand Kit

96-6950

Takasago BINAP Ligand Kit

Manufactured under license of Takasago patent.

Components also available for individual sale.

Contains the following:

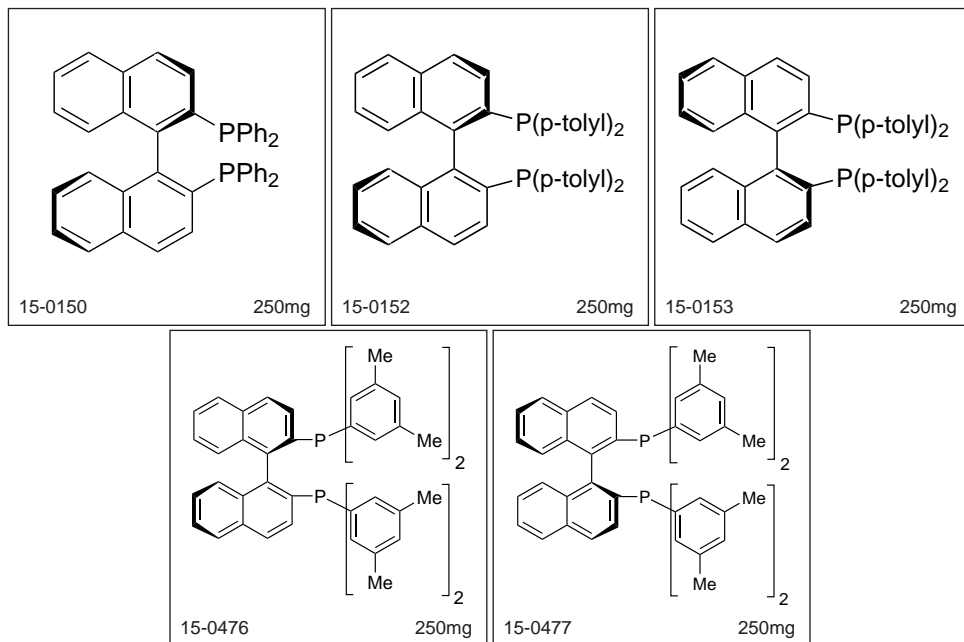

15-0150	(R)-(+)-2,2'-Bis(diphenylphosphino)-1,1'-binaphthyl, 98% (R)-(+)-BINAP (76189-55-4)	250mg	See page 267
15-0151	(S)-(-)-2,2'-Bis(diphenylphosphino)-1,1'-binaphthyl, 98% (S)-(-)-BINAP (76189-56-5)	250mg	See page 267
15-0152	(R)-(+)-2,2'-Bis(di-p-tolylphosphino)-1,1'-binaphthyl, 98% (R)-(+)-ToIBINAP (99646-28-3)	250mg	See page 275
15-0153	(S)-(-)-2,2'-Bis(di-p-tolylphosphino)-1,1'-binaphthyl, 98% (S)-(-)-ToIBINAP (100165-88-6)	250mg	See page 275
15-0476	(R)-(+)-2,2'-Bis[di(3,5-xyllyl)phosphino]-1,1'-binaphthyl, 98% (R)-(+)-XylBINAP (137219-86-4)	250mg	See page 276
15-0477	(S)-(-)-2,2'-Bis[di(3,5-xyllyl)phosphino]-1,1'-binaphthyl, 98% (S)-(-)-XylBINAP (135139-00-3)	250mg	See page 276

LIGAND KITS - Takasago SEGPPOS® Ligand Kit

96-6900

Takasago SEGPPOS® Ligand Kit

Manufactured under license of Takasago patent.

Components also available for individual sale.

Contains the following:

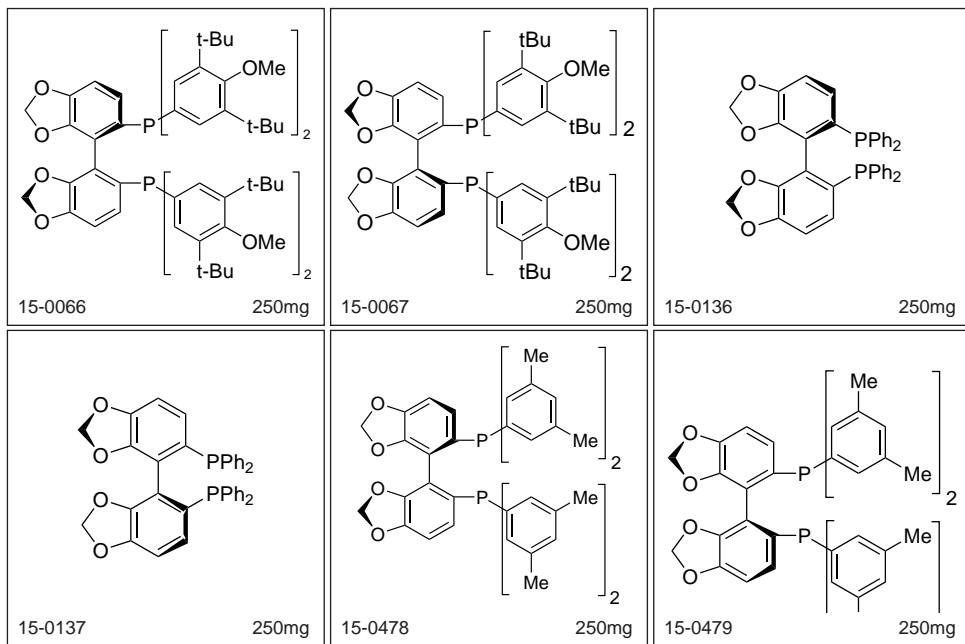

15-0066	(R)-(-)-5,5'-Bis[di(3,5-di-t-butyl-4-methoxyphenyl)phosphino]-4,4'-bi-1,3-benzodioxole, min. 98% (R)-(-)-DTBM-SEGPPOS® (566940-03-2)	250mg	See page 259
15-0067	(S)-(+)-5,5'-Bis[di(3,5-di-t-butyl-4-methoxyphenyl)phosphino]-4,4'-bi-1,3-benzodioxole, min. 98% (S)-(+)-DTBM-SEGPPOS® (210169-40-7)	250mg	See page 260
15-0136	(R)-(+)-5,5'-Bis(diphenylphosphino)-4,4'-bi-1,3-benzodioxole, min. 98% (R)-(+)-SEGPPOS® (244261-66-3)	250mg	See page 266
15-0137	(S)-(-)-5,5'-Bis(diphenylphosphino)-4,4'-bi-1,3-benzodioxole, min. 98% (S)-(-)-SEGPPOS® (210169-54-3)	250mg	See page 266
15-0478	(R)-(+)-5,5'-Bis[di(3,5-xyllyl)phosphino]-4,4'-bi-1,3-benzodioxole, min. 98% (R)-(+)-DM-SEGPPOS® (850253-53-1)	250mg	See page 276
15-0479	(S)-(-)-5,5'-Bis[di(3,5-xyllyl)phosphino]-4,4'-bi-1,3-benzodioxole, min. 98% (S)-(-)-DM-SEGPPOS® (210169-57-6)	250mg	See page 276

LIGAND KITS - UREAphos & METAMORPhos Ligand Kit**96-3740 UREAphos and METAMORPhos Ligand Kit for Asymmetric Hydrogenation**

Sold under license from InCatT for research purposes only.

WO2004/103559, WO2009/065853

Components also available for individual sale.

Contains the following:

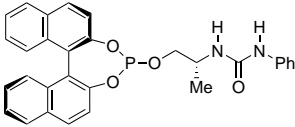
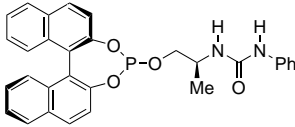
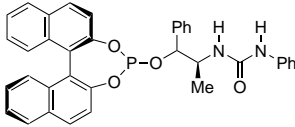
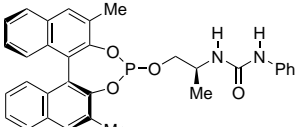
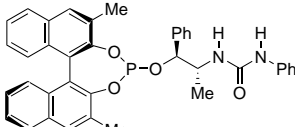
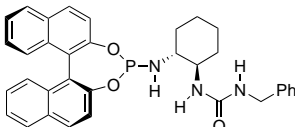
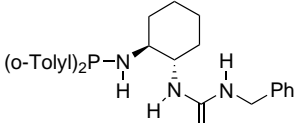
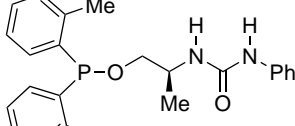
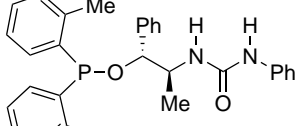
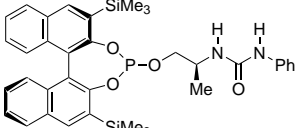
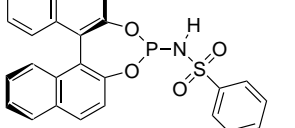
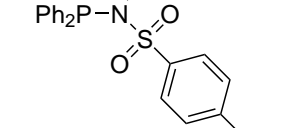
 <p>15-2200 50mg</p>	 <p>15-2201 50mg</p>	 <p>15-2202 50mg</p>
 <p>15-2204 50mg</p>	 <p>15-2206 50mg</p>	 <p>15-2208 50mg</p>
 <p>15-2210 50mg</p>	 <p>15-2212 50mg</p>	 <p>15-2214 50mg</p>
 <p>15-2216 50mg</p>	 <p>15-2218 50mg</p>	 <p>15-2220 50mg</p>

LIGAND KITS - UREAPhos & METAMORPhos Ligand Kit

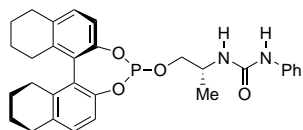

15-2222

50mg

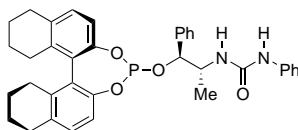

15-2224

50mg

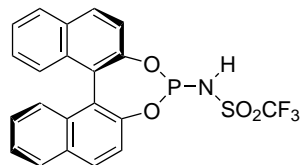

15-2228

50mg

15-2200	1-((2R)-1-((11bR)-Dinaphtho[2,1-d:1',2'-f][1,3,2]dioxaphosphepin-4-yloxy)propan-2-yl)-3-phenylurea, min. 97% UREAPhos (1198080-53-3)	50mg	See page 300
15-2201	1-((2S)-1-((11bR)-Dinaphtho[2,1-d:1',2'-f][1,3,2]dioxaphosphepin-4-yloxy)propan-2-yl)-3-phenylurea, min. 97% (1357562-63-0)	50mg	See page 300
15-2202	1-((1R,2S)-1-((11bR)-Dinaphtho[2,1-d:1',2'-f][1,3,2]dioxaphosphepin-4-yloxy)-1-phenylpropan-2-yl)-3-phenylurea, min. 97% (1198080-55-5)	50mg	See page 300
15-2204	1-((2S)-1-((11bS)-2,6-Dimethyldinaphtho[2,1-d:1',2'-f][1,3,2]dioxaphosphepin-4-yloxy)propan-2-yl)-3-phenylurea, min. 97% (1357562-63-0)	50mg	See page 298
15-2206	1-((1S,2R)-1-((11bR)-2,6-Dimethyldinaphtho[2,1-d:1',2'-f][1,3,2]dioxaphosphepin-4-yloxy)-1-phenylpropan-2-yl)-3-phenylurea, min. 97% (1858223-86-5)	50mg	See page 298
15-2208	1-Benzyl-3-((1R,2R)-2-((11bS)-dinaphtho[2,1-d:1',2'-f][1,3,2]dioxaphosphepin-4-ylamino)cyclohexyl)urea, min. 97% (1198080-57-7)	50mg	See page 251
15-2210	1-Benzyl-3-((1S,2S)-2-(di-o-tolylphosphinoamino)cyclohexyl)urea, min. 97% (1858223-87-6)	50mg	See page 251
15-2212	1-((2S)-1-(Di-o-tolylphosphinooxy)propan-2-yl)-3-phenylurea, min. 97%	50mg	See page 312
15-2214	1-((1R,2S)-1-(Di-o-tolylphosphinooxy)-1-phenylpropan-2-yl)-3-phenylurea, min. 97% (1391410-56-2)	50mg	See page 312
15-2216	1-((2S)-1-((11bR)-2,6-Bis(trimethylsilyl)dinaphtho[2,1-d:1',2'-f][1,3,2]dioxaphosphepin-4-yloxy)propan-2-yl)-3-phenylurea, min. 97% (1357562-70-9)	50mg	See page 281
15-2218	4-Butyl-N-((11bR)-dinaphtho[2,1-d:1',2'-f][1,3,2]dioxaphosphepin-4-yl)benzenesulfonamide triethylamine adduct, min. 97% (1150592-91-8)	50mg	See page 282
15-2220	4-Butyl-N-(diphenylphosphino)benzenesulfonamide, min. 97% (1025096-61-0)	50mg	See page 282
15-2222	1-((2R)-1-((11bR)-8,9,10,11,12,13,14,15-Octahydrodinaphtho[2,1-d:1',2'-f][1,3,2]dioxaphosphepin-4-yloxy)propan-2-yl)-3-phenylurea, min. 97% (1858223-90-1)	50mg	See page 316
15-2224	1-((1S,2R)-1-((11bR)-8,9,10,11,12,13,14,15-Octahydrodinaphtho[2,1-d:1',2'-f][1,3,2]dioxaphosphepin-4-yloxy)-1-phenylpropan-2-yl)-3-phenylurea, min. 97% (1858224-21-1)	50mg	See page 316
15-2228	N-((11bS)-Dinaphtho[2,1-d:1',2'-f][1,3,2]dioxaphosphepin-4-yl)-1,1,1-trifluoromethanesulfonamide triethylamine adduct, min. 97% METAMORPhos (1493790-73-0)	50mg	See page 301

METAL SCAVENGING KITS - BASF Metals Scavenging Agent Kit (MSA Kit)

- 96-6700 BASF Metals Scavenging Agent Kit (MSA Kit)**
 Sold in collaboration with BASF for research purposes only. .
 Components also available for individual sale.
 Contains the following:

06-0805	Metals scavenging agent, Phosphotungstic acid modified activated carbon (BASF MSA-FC C-1) (7440-44-0)	10g	See page 133
13-6300	Metals scavenging agent, Phosphotungstic acid modified alumina (BASF MSA-FC Al-1) (1344-28-1)	10g	See page 133
14-4353	Metals scavenging agent, Mercaptopropyl modified silica (BASF MSA-FC Si-3) (112926-00-8)	10g	See page 133

METAL SCAVENGING KITS - PhosphonicS Metals Scavenging Kit

- 96-6750 PhosphonicS Metals Scavenging Kit**
 Sold in collaboration with PhosphonicS Ltd. for research purposes only.
 Components also available for individual sale.
 Contains the following:

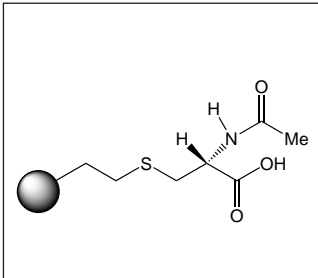
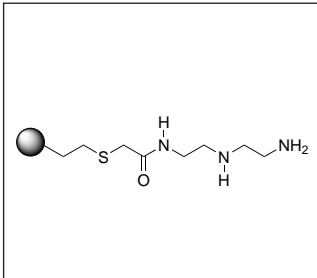
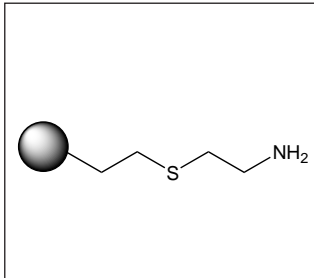
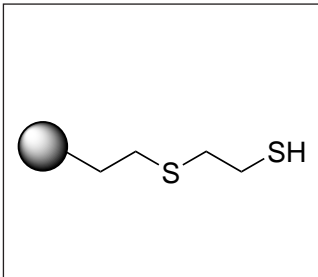
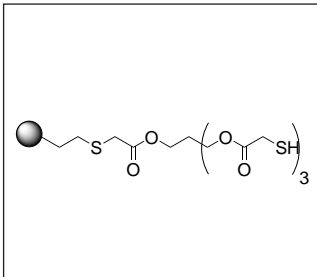
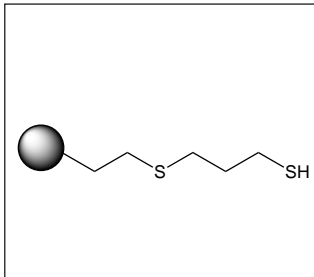
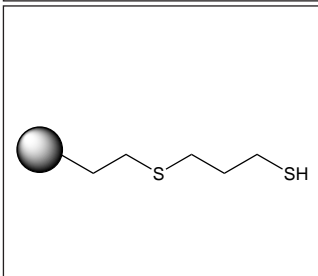
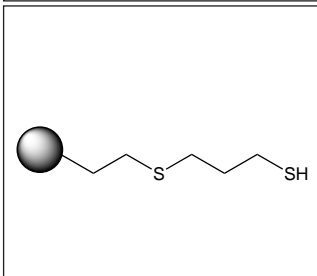
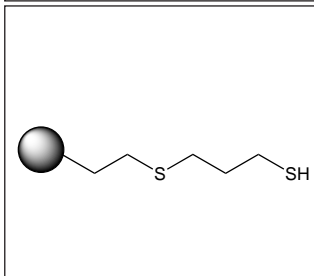
	16-0200	10g		16-0210	10g		16-0215	10g
	16-0650	10g		16-1540	10g		16-1700	10g
	16-1702	10g		16-1704	10g		16-1706	10g

METAL SCAVENGING KITS - PhosphonicS Metals Scavenging Kit

16-0200	N-Acetyl-L-cysteine ethyl Silica (PhosphonicS SCYT1) (7631-86-9)	10g	See page 128
16-0210	Triamine ethyl sulfide amide Silica (PhosphonicS STA3)	10g	See page 134
16-0215	2-Aminoethyl sulfide ethyl Silica (PhosphonicS SEA)	10g	See page 128
16-0650	2-Mercaptoethyl ethyl sulfide Silica (PhosphonicS SEM26) (7631-86-9)	10g	See page 132
16-1540	Pentaerythritol 2-mercaptoacetate ethyl sulfide Silica (PhosphonicS SET)	10g	See page 134
16-1700	3-Mercaptopropyl ethyl sulfide Silica (60+, high-cross linking) (PhosphonicS SPM36) (7631-86-9)	10g	See page 132
16-1702	3-Mercaptopropyl ethyl sulfide Silica (90+, high-cross linking) (PhosphonicS SPM36f)	10g	See page 133
16-1704	3-Mercaptopropyl ethyl sulfide Silica (90+, low-cross linking) (PhosphonicS SPM32f)	10g	See page 133
16-1706	3-Mercaptopropyl ethyl sulfide Silica (60+, low-cross linking) (PhosphonicS SPM32)	10g	See page 133

Metal scavengers are increasingly used as an effective way to solve metal removal problems associated with Active Pharmaceutical Ingredients (API's) and synthetic intermediates. This is an often complex technical challenge, influenced by a number of factors including the significant structural variations with API's, the polar functional groups which APIs tend to contain, the environment (solvent and pH) and potential incompatibilities within the API. PhosphincS has designed a portfolio of silica-based materials containing a diverse range of functional groups to address effective metal scavenging.

Properties of PhosphonicS' Broad Portfolio of Metal Scavengers

- High affinity for a wide range of metals, in different oxidation states
- Fast kinetics - highly active at ambient temperatures
- High selectivity for the metal, meaning minimal loss of the API/compound
- Broad solvent and pH compatibility with both organic and aqueous formulations, reducing the requirements of time-consuming and costly solvent switches
- No swelling of the materials are required
- Excellent stability - thermal, physical, chemical and mechanical
- Very high purity - eliminating issues of extractable impurities
- Enhanced performance, due to multiple functional groups and higher effective loadings
- Metal recycling options
- Availability on process scale

Performance Benefits from using PhosphonicS' Metal Scavengers

- **Faster:** purification, batch processing, problem-solving, market introduction
- **Reduced:** development time, valuable API losses, total manufacturing costs, environmental burden
- **Enhanced:** process, productivity, compliance

NANOMATERIAL KITS - Cadmium selenide CANdot® Quantum Dot (CdSe core) Kit

96-0800 **Cadmium selenide CANdot® quantum dot (CdSe core) kit, 50umol/L in**
HAZ hexanes, 525-625nm peak emissions
 Sold in collaboration with CAN for research purposes.
 Components also available for individual sale.
 Contains the following:

48-1011	Cadmium selenide CANdot® quantum dot (CdSe core), 50umol/L in hexanes, 525nm peak emission (1306-24-7)	5ml	See page 139
48-1017	Cadmium selenide CANdot® quantum dot (CdSe core), 50umol/L in hexanes, 550nm peak emission (1306-24-7)	5ml	See page 139
48-1023	Cadmium selenide CANdot® quantum dot (CdSe core), 50umol/L in hexanes, 575nm peak emission (1306-24-7)	5ml	See page 139
48-1030	Cadmium selenide CANdot® quantum dot (CdSe core), 50umol/L in hexanes, 600nm peak emission (1306-24-7)	5ml	See page 139
48-1035	Cadmium selenide CANdot® quantum dot (CdSe core), 50umol/L in hexanes, 625nm peak emission (1306-24-7)	5ml	See page 139

Item #	Peak Emission	Particle size (diameter)	Quantum Yield
48-1011	525nm	2.8nm	>20%
48-1017	550nm	3.5nm	>10%
48-1023	575nm	3.9nm	>10%
48-1030	600nm	4.7nm	>20%
48-1035	625nm	5.3nm	>20%

Kit contains 5ml of each of the above 5 products. Ligand capping agent oleylamine. Stable in dispersions > 6 months.
 *Particle size reported excludes ligand capping agent. All sizes determined by TEM.
 † Available at nanoparticle concentration of 50µmol per liter.

NANOMATERIAL KITS - Cadmium selenide/cadmium sulfide CANdot® Quantum Rod Kit

96-0813 **Cadmium selenide/cadmium sulfide CANdot® quantum rod kit (CdSe/CdS elongat-**
HAZ ed core/shell), 5 mg/ml in hexanes, 560nm, 590nm, 620nm peak emissions
 Sold in collaboration with CAN for research purposes.
 Components also available for individual sale.
 Contains the following:

48-1053	Cadmium selenide/cadmium sulfide CANdot® quantum rod (CdSe/CdS elongated core/shell), 5 mg/ml in hexanes, 560nm peak emission (1306-24-7)	0.5ml	See page 139
48-1056	Cadmium selenide/cadmium sulfide CANdot® quantum rod (CdSe/CdS elongated core/shell), 5 mg/ml in hexanes, 590nm peak emission (1306-24-7)	0.5ml	See page 139
48-1059	Cadmium selenide/cadmium sulfide CANdot® quantum rod (CdSe/CdS elongated core/shell), 5 mg/ml in hexanes, 620nm peak emission (1306-24-7)	0.5ml	See page 139

NANOMATERIAL KITS - Gold Gemini Nanorods Kit, CTAB Free

96-1549

Gold Gemini Nanorods Kit, CTAB Free (Wavelength 650-850 nm)**NEW**

Rods are synthesized without CTAB. Store at 4°C - 8°C. Do not freeze. At storage temperature the product may appear opaque. Follow the procedure for re-dispersing surfactants as described in the technical note. Complete this process before use to dissolve precipitated stabilizer.

Sold in collaboration with SONA Nanotech for research purposes only.

Components also available for individual sale.

Contains the following:

79-7010	Gold Gemini Nanorods, CTAB Free (Wavelength 650 nm) (7440-57-5)	5ml	See page 157
79-7015	Gold Gemini Nanorods, CTAB Free (Wavelength 700 nm) (7440-57-5)	5ml	See page 157
79-7020	Gold Gemini Nanorods, CTAB Free (Wavelength 750 nm) (7440-57-5)	5ml	See page 157
79-7025	Gold Gemini Nanorods, CTAB Free (Wavelength 800 nm) (7440-57-5)	5ml	See page 157
79-7030	Gold Gemini Nanorods, CTAB Free (Wavelength 850 nm) (7440-57-5)	5ml	See page 157

Item #	LPSR Maximum (nm)	Length (nm)	Width (nm)	Aspect Ratio	Color & Form
79-7010	640 - 670	25 - 31	13 - 18	1.7 - 1.9	violet liq.
79-7015	685 - 715	37 - 43	13 - 18	2.4 - 2.8	blue liq.
79-7020	735 - 765	37 - 44	10 - 13	3.4 - 3.7	red-purple liq.
79-7025	785 - 815	40 - 50	10 - 13	3.8 - 4.1	red-orange liq.
79-7030	835 - 865	48 - 55	9 - 12	4.6 - 5.3	maroon-purple liq.

Concentration: >30 µg/ml
pH: 5.5 - 7.5
Stabilizer: Amphiphilic Agents
Solvent: Stabilized with amphiphilic agents in conductivity grade water (18.0 MΩ cm⁻¹)
Optical Density: 1.0 - 1.2
Shelf Life: 12 months

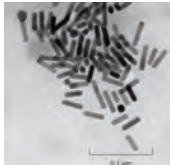
NANOMATERIAL KITS - Gold Nanoparticles Kit

96-1547

Gold Nanoparticles Kit (5nm-40nm diameter, OD 1, stabilized suspension citrate buffer)

Components also available for individual sale.

Contains the following:

79-0182	Gold Nanoparticles (5nm, 1 OD, supplied in 0.1mM stabilizing surfactant, 515-520nm abs. max.) (7440-57-5)	25ml	See page 153
79-0210	Gold Nanoparticles (10nm, 1 OD, supplied in 0.1mM stabilizing surfactant, 515-520nm abs. max.) (7440-57-5)	25ml	See page 153
79-0212	Gold Nanoparticles (15nm, 1 OD, supplied in 0.1mM stabilizing surfactant, 520nm abs. max.) (7440-57-5)	25ml	See page 153
79-0214	Gold Nanoparticles (20nm, 1 OD, supplied in 0.1mM stabilizing surfactant, 524nm abs. max.) (7440-57-5)	25ml	See page 153
79-0216	Gold Nanoparticles (30nm, 1 OD, supplied in 0.1mM stabilizing surfactant, 526nm abs. max.) (7440-57-5)	25ml	See page 153
79-0218	Gold Nanoparticles (40nm, 1 OD, supplied in 0.1mM stabilizing surfactant, 530nm abs. max.) (7440-57-5)	25ml	See page 153

NANOMATERIAL KITS - Gold Nanoparticles Kit, Reactant Free**96-1545 Gold Nanoparticles Kit, Reactant-Free (5nm-40nm diameter, OD 1, suspension in phosphate-buffered saline, 515-530nm abs. max.)**

Components also available for individual sale.

Contains the following:

79-0180	Gold Nanoparticles (5 nm diameter, 1 OD, stabilized suspension in phosphate-buffered saline, 515-520 nm abs. max.) reactant free (7440-57-5)	25ml	See page 152
79-0184	Gold Nanoparticles (10nm diameter, 1 OD, stabilized suspension in phosphate-buffered saline, 520nm abs. max.) reactant free (7440-57-5)	25ml	See page 152
79-0186	Gold Nanoparticles (15nm diameter, 1 OD, stabilized suspension in phosphate-buffered saline, 520nm abs. max.) reactant free (7440-57-5)	25ml	See page 152
79-0188	Gold Nanoparticles (20nm diameter, 1 OD, stabilized suspension in phosphate-buffered saline, 524nm abs. max.) reactant free (7440-57-5)	25ml	See page 152
79-0190	Gold Nanoparticles (30nm diameter, 1 OD, stabilized suspension in phosphate-buffered saline, 526nm abs. max.) reactant free (7440-57-5)	25ml	See page 152
79-0192	Gold Nanoparticles (40nm diameter, 1 OD, stabilized suspension in phosphate-buffered saline, 530nm abs. max.) reactant free (7440-57-5)	25ml	See page 152

NANOMATERIAL KITS - Gold Nanorods Kit (Axial Diameter - 25nm)**96-1530 Gold Nanorods Kit (Axial Diameter - 25 nm, wavelength 550-700 nm)**

Components also available for individual sale.

Contains the following:

79-6000	Gold Nanorods (Axial Diameter - 25 nm) (Wavelength 550 nm) (7440-57-5)	25ml	See page 156
79-6005	Gold Nanorods (Axial Diameter - 25 nm) (Wavelength 600 nm) (7440-57-5)	25ml	See page 156
79-6010	Gold Nanorods (Axial Diameter - 25 nm) (Wavelength 650 nm) (7440-57-5)	25ml	See page 156
79-6015	Gold Nanorods (Axial Diameter - 25 nm) (Wavelength 700 nm) (7440-57-5)	25ml	See page 156

NANOMATERIAL KITS - Gold Nanorods Kit (Axial Diameter - 10nm)**96-1535 Gold Nanorods Kit (Axial Diameter - 10 nm, wavelength 700-808 nm)**

Components also available for individual sale.

Contains the following:

79-6020	Gold Nanorods (Axial Diameter - 10 nm) (Wavelength 700 nm) (7440-57-5)	25ml	See page 156
79-6025	Gold Nanorods (Axial Diameter - 10 nm) (Wavelength 750 nm) (7440-57-5)	25ml	See page 156
79-6030	Gold Nanorods (Axial Diameter - 10 nm) (Wavelength 780 nm) (7440-57-5)	25ml	See page 156
79-6035	Gold Nanorods (Axial Diameter - 10 nm) (Wavelength 808 nm) (7440-57-5)	25ml	See page 156

NANOMATERIAL KITS - Gold Nanospheres Kit**96-1540 Gold Nanospheres Kit (30-90 nm)**

Components also available for individual sale.

Contains the following:

79-6040	Spherical Gold Nanoparticles (30 nm) (7440-57-5)	25ml	See page 154
79-6045	Spherical Gold Nanoparticles (50 nm) (7440-57-5)	25ml	See page 154
79-6050	Spherical Gold Nanoparticles (70 nm) (7440-57-5)	25ml	See page 154
79-6055	Spherical Gold Nanoparticles (90 nm) (7440-57-5)	25ml	See page 154

NANOMATERIAL KITS - Graphene Quantum Dots (GQDs) Master Kit

96-7410

Graphene Quantum Dots (GQDs) Master Kit**NEW**

Sold in collaboration with Dotz Nano Ltd. for research purposes only.

Suggested use within 6 months of purchase. Do not freeze. Store in DARK.

Components also available for individual sale.

Contains the following:

06-0330	Graphene Quantum Dots (GQDs), Aqua-Green Luminescent (1034343-98-0)	100mg	See page 147
06-0332	Graphene Quantum Dots (GQDs) in water, Aqua-Green Luminescent (1034343-98-0)	100ml	See page 147
06-0334	Graphene Quantum Dots (GQDs), Blue Luminescent (1034343-98-0)	100mg	See page 147
06-0336	Graphene Quantum Dots (GQDs) in water, Blue Luminescent (1034343-98-0)	100ml	See page 148
06-0338	Graphene Quantum Dots (GQDs), Cyan Luminescent (1034343-98-0)	100mg	See page 148
06-0340	Graphene Quantum Dots (GQDs) in water, Cyan Luminescent (1034343-98-0)	100ml	See page 148

Item #	Photoluminescence			
	QY* *	λ max *	Max emission	FWHM *
06-0330 / 06-0332	>17%	485 nm	525 nm	70 nm
06-0334 / 06-0336	>65%	350 nm	445 nm	65 nm
06-0338 / 06-0340	>25%	420 nm	490 nm	80 nm
Particle diameter: <5 nm Topographic height: 1.0 - 2.0 nm Concentration: 1mg/ml (for liquid items)				
Abbreviations: QY* = Quantum Yield; λ max = Maximum excitation wavelength; FWHM = Full width at half maximum				

NANOMATERIAL KITS - Graphene Quantum Dots (GQDs) Mini Kit (Powders)

96-7425

Graphene Quantum Dots (GQDs) Mini Kit (Powders)**NEW**

Sold in collaboration with Dotz Nano Ltd. for research purposes only.

Suggested use within 6 months of purchase. Do not freeze. Store in DARK.

Components also available for individual sale.

Contains the following:

06-0330	Graphene Quantum Dots (GQDs), Aqua-Green Luminescent (1034343-98-0)	100mg	See page 147
06-0334	Graphene Quantum Dots (GQDs), Blue Luminescent (1034343-98-0)	100mg	See page 147
06-0338	Graphene Quantum Dots (GQDs), Cyan Luminescent (1034343-98-0)	100mg	See page 148

Item #	Color & Form	Photoluminescence			
		QY* *	λ max *	Max emission	FWHM *
06-0330	dark red-brown pwdr.	>17%	485 nm	525 nm	70 nm
06-0334	dark brown pwdr.	>65%	350 nm	445 nm	65 nm
06-0338	dark brown pwdr.	>25%	420 nm	490 nm	80 nm
Particle diameter: <5 nm Topographic height: 1.0 - 2.0 nm					
Abbreviations: QY* = Quantum Yield; λ max = Maximum excitation wavelength; FWHM = Full width at half maximum					

NANOMATERIAL KITS - Graphene Quantum Dots (GQDs) Mini Kit (Liquids)

96-7420

Graphene Quantum Dots in water (GQDs) Mini Kit (Liquids)**NEW**

Sold in collaboration with Dotz Nano Ltd. for research purposes only.

Suggested use within 6 months of purchase. Do not freeze. Store in DARK.

Components also available for individual sale.

Contains the following:

06-0332	Graphene Quantum Dots (GQDs) in water, Aqua-Green Luminescent (1034343-98-0)	100ml	See page 147
06-0336	Graphene Quantum Dots (GQDs) in water, Blue Luminescent (1034343-98-0)	100ml	See page 148
06-0340	Graphene Quantum Dots (GQDs) in water, Cyan Luminescent (1034343-98-0)	100ml	See page 148

Item #	Color & Form	Photoluminescence			
		QY* *	λ max *	Max emission	FWHM *
06-0332	cloudy orange liq.	>17%	485 nm	525 nm	70 nm
06-0336	cloudy colorless liq.	>65%	350 nm	445 nm	65 nm
06-0340	cloudy brown liq.	>25%	420 nm	490 nm	80 nm

Particle diameter: <5 nm
Topographic height: 1.0 - 2.0 nm
Concentration: 1mg/ml

Abbreviations: QY* = Quantum Yield; λ max = Maximum excitation wavelength; FWHM = Full width at half maximum

OTHER KITS - Biological Hydrogen Peroxide Imaging Kit (FBBBE, CBBE)

96-0350

Biological Hydrogen Peroxide Imaging Kit (FBBBE, CBBE)

Includes:

6 x 1.0ml Dimethylsulfoxide (ACS spectrophotometric grade): 97-4940

05-0058 FBBBE: 3 x 5mg

05-0054 CBBE: 3 x 5mg

Sold under license from The Regents of the University of California. US Patent application 61/762,706.

Components also available for individual sale.

Contains the following:

05-0054	7-[[[4,4,5,5-Tetramethyl-1,3,2-dioxaborolan-2-yl]benzyl]oxy]-2H-1-benzopyran-2-one CBBE (1522117-80-1)	5mg	See page 29
05-0058	3',6'-Bis[[[4-(4,4,5,5-tetramethyl-1,3,2-dioxaborolan-2-yl)oxy]-3H-[spiro(isobenzofuran-1,9,-xanthen)-3-one] FBBBE (1522117-83-4)	5mg	See page 25

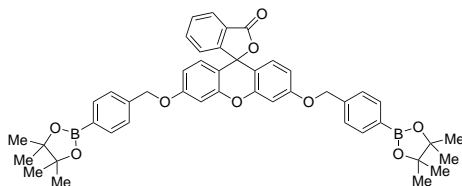
Active Ingredients: Catalog # 05-0058 Fluorescein bis(benzyl boronic ester) **FBBE**Catalog # 05-0054 Coumarin benzyl boronic ester **CBBE**

05-0058 FBBE

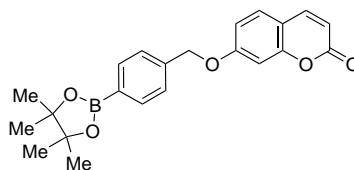

05-0054 CBBE

OTHER KITS - Biological Hydrogen Peroxide Imaging Kit (FBBBE, CBBE)96-0350 Biological Hydrogen Peroxide Imaging Kit (FBBBE, CBBE) (*continued*)

Introduction:	<p>FBBBE and CBBE are robust fluorescent probes, effective for imaging hydrogen peroxide in biological settings. In the supplied form, the fluorescence signal is effectively quenched by the addition of the benzyl ether boronic ester protecting groups to the fluorophores. In the presence of biologically relevant levels of hydrogen peroxide (10-200 :M), the protecting groups cleave and a strong fluorescent signal is observed. (FBBBE: λ_{exc} = 480 nm, λ_{em} = 512 nm; CBBE: λ_{exc} = 370 nm, λ_{em} = 450 nm)</p> <p>1. <i>ChemBioChem</i>, 2013, 14, 593.</p>
Contents:	<p>FBBBE: 3x5mg CBBE: 3x5mg Dimethylsulfoxide (ACS spectrophotometric grade): 6 x 1.0mL</p>
SDS:	<p>The Safety Data Sheets for the three products contained in this kit can be downloaded from the Strem Chemicals Web Site at www.strem.com. Locate the SDS using the following catalog numbers: FBBBE: 05-0058 CBBE: 05-0054 Dimethylsulfoxide (ACS spectrophotometric grade): 97-4940</p>
Storage Conditions:	Both compounds are stable at ambient conditions for several days. For long term storage, the kit should be stored at -20°C and protected from light.

Preparation of FBBBE:	<p>Step 1: Add 654 μL of DMSO to 5.0mg of FBBBE (MW: 764.3 g/mol) (resulting concentration = 10 mM). FBBBE is readily soluble in DMSO. The solution can be portioned into 50 μL aliquots as needed. These solutions must be stored in the freezer at < -20°C.</p> <p>Step 2: Add 50 μL of 10 mM stock to 50 μL DMSO (resulting concentration = 5 mM). This stock solution can be stored in the freezer at < -20°C.</p> <p>Step 3: This solution can be further diluted to the desired concentration in buffer. For example add 10μL of the 5 mM stock solution to 990μL 1X PBS, resulting in a 50 μM solution (this solution should be used the same day in which it was prepared). This will result in a solution containing only 1% DMSO (v/v). This solution can then be used in the biological setting to image H₂O₂.</p>
Preparation of CBBE:	<p>Step 1: Add 661 μL of DMSO to 5.0 mg CBBE (MW: 378.2 g/mol) (resulting concentration = 20 mM). Vortex until all solid has been thoroughly dissolved. The solution can be portioned into 50 μL aliquots as needed. These solutions must be stored in the freezer at < -20°C.</p> <p>Step 2: Add 50 μL of 20 mM stock to 150 μL DMSO (resulting concentration = 5 mM). This stock solution can be stored in the freezer at < -20°C.</p> <p>Step 3: The solution can be further diluted to the desired concentration in buffer. For example add 10 μL of the 5 mM stock solution to 990 μL 1X PBS, resulting in a 50μM solution (this solution should be used the same day in which it was prepared). This will result in a solution containing only 1% DMSO (v/v). This solution can then be used to image H₂O₂ in the biological setting.</p>

OTHER KITS - Cucurbituril Kit

96-7054

Cucurbituril Kit

Sold for research purposes only. US 6365734, US 7388099.

Components also available for individual sale.

Contains the following:

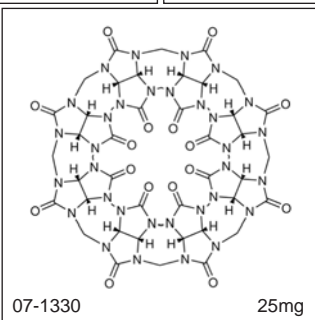
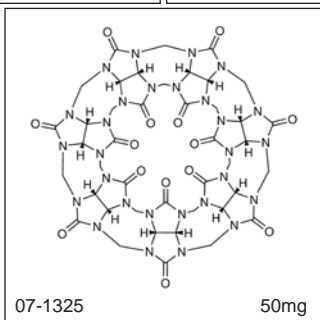
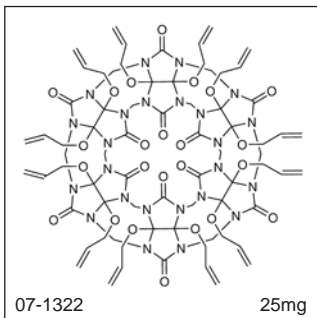
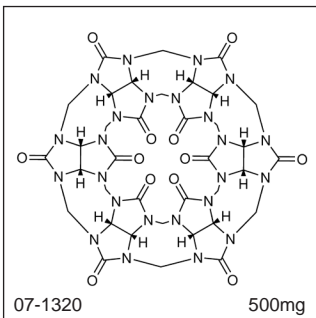
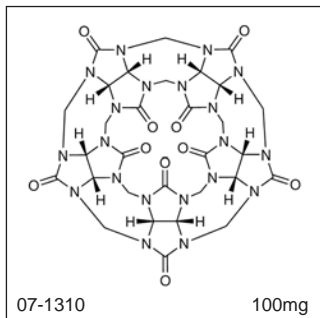

07-1310	Cucurbit[5]uril (CB[5]) ammonium sulfate hydrate, 99+% (259886-49-2)	100mg	See page 192
07-1320	Cucurbit[6]uril (CB[6]) hydrate, 99+% (80262-44-8)	500mg	See page 192
07-1322	Perallyloxycucurbit[6]uril (AOCB[6]) potassium sulfate, 94+% (558445-90-2)	25mg	See page 205
07-1325	Cucurbit[7]uril (CB[7]) hydrate, 99+% (259886-50-5)	50mg	See page 192
07-1330	Cucurbit[8]uril (CB[8]) hydrate, 99+% (259886-51-6)	25mg	See page 192

OTHER KITS - Enzyme Carrier Lifetech™ ECRKIT1

96-0255

Enzyme carrier Lifetech™ ECRKIT1**NEW**

Store in dry conditions (2-20°C). Do not freeze. Shelf Life: 5 years; This enzyme carrier kit allows rapid screening of different methods of enzyme immobilization. Sold in collaboration with Purolite for research purposes only. Components also available for individual sale. Contains the following:

06-0810	Enzyme carrier Lifetech™ ECR8204F	50g	See page 16
06-0828	Enzyme carrier Lifetech™ ECR8285	50g	See page 20
06-0913	Enzyme carrier Lifetech™ ECR1090M	50g	See page 16
06-0925	Enzyme carrier Lifetech™ ECR1030M	50g	See page 15
07-1512	Enzyme carrier Lifetech™ ECR8309F	50g	See page 17
07-1532	Enzyme carrier Lifetech™ ECR8806F	50g	See page 19

OTHER KITS - Long-Chain n-Alkylphosphonic Acid Kit

96-1525

Long-Chain n-Alkylphosphonic Acid Kit

Components also available for individual sale. Contains the following:

15-0958	n-Decylphosphonic acid, min. 97% (6874-60-8)	1g	See page 284
15-1835	n-Dodecylphosphonic acid, min. 97% DDPA (5137-70-2)	1g	See page 312
15-2400	n-Hexadecylphosphonic acid, min. 97% HDPA (4721-17-9)	1g	See page 313
15-2410	n-Hexylphosphonic acid, min. 97% HPA (4721-24-8)	1g	See page 313
15-3510	n-Octadecylphosphonic acid, min. 97% ODPa (4724-47-4)	1g	See page 316
15-3520	n-Octylphosphonic acid, min. 97% OPA (4724-48-5)	1g	See page 318
15-5145	n-Tetradecylphosphonic acid, min. 97% TDPA (4671-75-4)	1g	See page 321

General Use:

Linear alkyl Phosphonic acids and their phosphonate salts are surfactants because of their classic bifunctional chemical structure, $RP(O)(OH)_2$, consisting of both non-polar organic hydrophobic groups and anionic inorganic hydrophilic groups. Like the related alkyl sulfonates, they are used as detergents, dispersants, emulsifiers, and chelating agents. Alkyl phosphonic acids are typically sparingly soluble in both organic solvents and water, but become more soluble in water when neutralized to phosphonates at neutral to high pH.

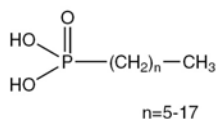
**OTHER KITS - Nitric Oxide Sensor (Extracellular) Kit ("NO-ON") (FL2A)**

96-0397

Nitric Oxide Sensor (Extracellular) Kit ("NO-ON") (FL2A) (Cell-impermeable NO fluorescent probe)**NEW**

Includes:

5 x 1ml Dimethylsulfoxide (ACS spectrophotometric grade): 97-4940

5 x 1ml Copper (II) chloride as a 1.0 mM solution in water: 97-3060

07-0287 packaged as 5 x 0.5mg

Contains the following:

07-0287	2-[4,5-Bis[(6-(2-ethoxy-2-oxohydroxy)-2-methylquinolin-8-ylamino)methyl]-6-hydroxy-3-oxo-3H-xanthen-9-yl]benzoic acid FL2A (1239877-07-6)	0.5mg	See page 185
---------	---	-------	--------------

OTHER KITS - Nitric Oxide Sensor (Extracellular) Kit ("NO-ON") (FL2A)

Active Ingredients: 2-{4,5-Bis[(6-(2-ethoxy-2-oxoethoxy)-2-methylquinolin-8-ylamino)methyl]-6-hydroxy-3-oxo-3H-xanthen-9-yl}benzoic acid FL2A

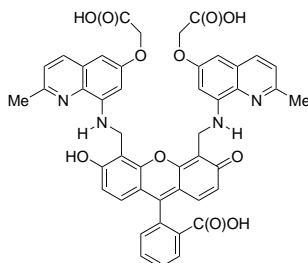
**07-0287**

Introduction:	The copper complex of FL2A is a novel, cell-trappable fluorescent NO probe, that allows direct imaging of nitric oxide produced in living cells through fluorescence turn on. The FL2A ligand is trapped in the cell. A solution of the copper (II) complex of FL2A can be readily prepared using this kit. For additional information, consult the following references: 1. <i>Inorg. Chem.</i> , 2010 , <i>49</i> , 7464. 2. <i>PNAS</i> , 2010 , <i>107</i> , 8525.
Contents:	Ligand FL2A : 5 x 0.5mg Dimethylsulfoxide (ACS spectrophotometric grade): 5 x 1.0ml Copper (II) chloride (1.0 mM solution in water): 5 x 1.0ml
SDS:	The Safety Data Sheets for the three products contained in this kit can be downloaded from the Strem Chemical website, www.strem.com . Locate the SDS using the following catalog numbers: 07-0287: FL2A 97-4940: Dimethylsulfoxide (ACS spectrophotometric grade) 97-3060: Copper (II) chloride as a 1.0 mM solution in water

Storage Conditions:	This kit should be stored at -20°C and protected from light.
Preparation of the active copper complex of FL2A:	<p>Step 1: Allow the kit to warm to room temperature. Add 589 microliters of DMSO to a 0.5mg vial of FL2A (resulting concentration -1.0 mM). The FL2A is readily soluble in the DMSO. The solution can be partitioned into aliquots of 40-300 μL as required. These solutions must be stored in the freezer at <-20°C. The DMSO solution of FL2A is stable for three months at -80°C. It is advisable to check the extinction coefficient of the solution before preparing the copper complex. ($\log \epsilon(499 \text{ nm}) = 4.66$)</p> <p>Step 2: A CuFL2A solution should be freshly prepared by adding 1:2 FL2A solution (1.0 mM) to the copper (II) solution (1.0 mM) at room temperature. Note: The prepared DMSO/water stock solution of CuFL2A solution [$\log \epsilon(495 \text{ nm}) = 4.19$] can be kept at room temperature, but should be protected from light. The solution can be diluted with media to provide the concentration required for cell sensing experiments. When the extinction coefficient of the red solution of CuFL2A diminishes by 20% of the original value, the solution should be discarded. Do not use the solution after 1 hour and do not freeze the solution.</p>

OTHER KITS - Nitric Oxide Sensor (Intracellular) Kit ("NO-ON") (FL)**96-0293 Nitric Oxide Sensor (Intracellular) Kit ("NO-ON") (FL) (Cell-trappable NO fluorescent probe)**

Includes:

5 x 1ml Dimethylsulfoxide (ACS spectrophotometric grade): 97-4940

5 x 1ml Copper (II) chloride as a 1.0 mM solution in water: 97-3060

07-0293 packaged as 5 x 0.5mg

Contains the following:

07-0293	2-[2-Chloro-6-hydroxy-5-[2-methylquinolin-8-ylaminomethyl]-3-oxo-3H-xanthen-9-yl]benzoic acid FL (905982-78-7)	0.5mg	See page 191
---------	--	-------	--------------

Active Ingredients: 2-[2-Chloro-6-hydroxy-5-[2-methylquinolin-8-ylamino)methyl]-3-oxo-3H-xanthen-9-yl]benzoic acid (FL)

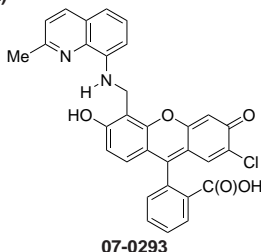

Introduction:	The copper complex of FL is a novel, cell-trappable fluorescent NO probe that allows direct imaging of nitric oxide produced in living cells through fluorescence turn on. A solution of the copper (II) complex of FL can be readily prepared using this kit. For additional information, consult the following references: <ol style="list-style-type: none"> 1. <i>Nature Chemical Biology</i>, 2006, 2, 375. 2. <i>Nature Protocols</i>, 2007, 2, 408. 3. <i>J. Am. Chem. Soc.</i>, 2006, 128, 14364
Contents:	Ligand FL: 5 x 0.5mg Dimethylsulfoxide (ACS spectrophotometric grade): 5 x 1.0ml Copper (II) chloride (1.0 mM solution in water): 5 x 1.0ml
SDS:	The Safety Data Sheets for the three products contained in this kit can be downloaded from the Strem Chemical website, www.strem.com . Locate the SDS using the following catalog numbers: 07-0293: FL 97-4940: Dimethylsulfoxide (ACS spectrophotometric grade) 97-3060: Copper (II) chloride as a 1.0 mM solution in water

Storage Conditions:	This kit should be stored at -20°C and protected from light.
Preparation of the active copper complex of FL:	<p>Step 1: Allow the kit to warm to room temperature. Add 931 microliters of DMSO to a 0.5mg vial of FL (resulting concentration -1.0 mM). The FL is readily soluble in the DMSO. The solution can be partitioned into aliquots of 40-300 µL as required. These solutions must be stored in the freezer at <-20°C. The DMSO solution of FL is stable for three months at -80°C. It is advisable to check the extinction coefficient of the solution before preparing the copper complex. (log ε(504 nm) = 4.62)</p> <p>Step 2: A CuFL solution should be freshly prepared by adding 1:1 FL solution (1.0 mM) to the copper (II) solution (1.0 mM) at room temperature. Note: The prepared DMSO/water stock solution of CuFL solution [log ε(499 nm) = 4.60] can be kept at room temperature, but should be protected from light. The solution can be diluted with media to provide the concentration required for cell sensing experiments. When the extinction coefficient of the red solution of CuFL diminishes by 20% of the original value, the solution should be discarded. Do not use the solution after 1 hour, and do not freeze the solution.</p>

OTHER KITS - Nitric Oxide Sensor (Intracellular) Kit ("NO-ON") (FL2E)**96-0396 Nitric Oxide Sensor (Intracellular) Kit ("NO-ON") (FL2E) (Cell-trappable NO fluorescent probe)**

Includes:

5 x 1ml Dimethylsulfoxide (ACS spectrophotometric grade): 97-4940

5 x 1ml Copper (II) chloride as a 1.0 mM solution in water: 97-3060

07-0291 packaged as 5 x 0.5mg

Contains the following:

07-0291	2-{4,5-Bis[(6-(2-ethoxy-2-oxoethoxy)-2-methylquinolin-8-ylamino)methyl]-6-hydroxy-3-oxo-3H-xanthen-9-yl}benzoic acid FL2E (1239877-06-5)	0.5mg	See page 184
---------	--	-------	--------------

Active Ingredients: 2-{4,5-Bis[(6-(2-ethoxy-2-oxoethoxy)-2-methylquinolin-8-ylamino)methyl]-6-hydroxy-3-oxo-3H-xanthen-9-yl}benzoic acid FL2E

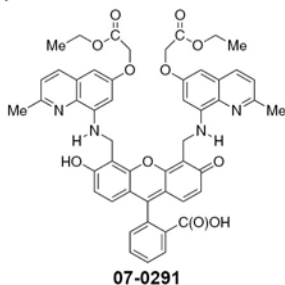

Introduction:	The copper complex of FL2E is a novel, cell-trappable fluorescent NO probe, that allows direct imaging of nitric oxide produced in living cells through fluorescence turn on. The FL2E ligand is trapped in the cell. A solution of the copper (II) complex of FL2E can be readily prepared using this kit. For additional information, consult the following references: 1. <i>Inorg. Chem.</i> , 2010 , <i>49</i> , 7464.
Contents:	Ligand FL2E: 5 x 0.5mg Dimethylsulfoxide (ACS spectrophotometric grade): 5 x 1.0ml Copper (II) chloride (1.0 mM solution in water): 5 x 1.0ml
SDS:	The Safety Data Sheets for the three products contained in this kit can be downloaded from the Strem Chemical website, www.strem.com . Locate the SDS using the following catalog numbers: 07-0291: FL2E 97-4940: Dimethylsulfoxide (ACS spectrophotometric grade) 97-3060: Copper (II) chloride as a 1.0 mM solution in water
Storage Conditions:	This kit should be stored at -20°C and protected from light.

Preparation of the active copper complex of FL2E:	<p>Step 1: Allow the kit to warm to room temperature. Add 571 microliters of DMSO to a 0.5mg vial of FL2E (resulting concentration -1.0 mM). The FL2E is readily soluble in the DMSO. The solution can be partitioned into aliquots of 40-300 µL as required. These solutions must be stored in the freezer at <-20°C. The DMSO solution of FL2E is stable for three months at -80°C. It is advisable to check the extinction coefficient of the solution before preparing the copper complex. (log ε(500 nm) = 4.25)</p> <p>Step 2: A CuFL2E solution should be freshly prepared by adding 1:1 FL2E solution (1.0 mM) to the copper (II) solution (1.0 mM) at room temperature. Note: The prepared DMSO/water stock solution of CuFL2E solution [log ε(496 nm) = 4.05] can be kept at room temperature, but should be protected from light. The solution can be diluted with media to provide the concentration required for cell sensing experiments. When the extinction coefficient of the red solution of CuFL2E diminishes by 20% of the original value, the solution should be discarded. Do not use the solution after 1 hour, and do not freeze the solution.</p>
--	---

OTHER KITS - Paracyclophane Kit

96-7052

Paracyclophane Kit

Components also available for individual sale. Contains the following:

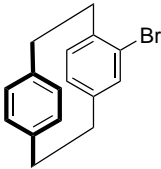
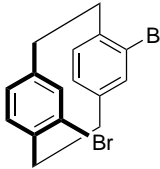
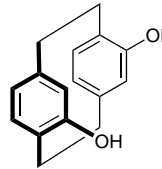
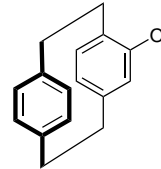
			
06-0104	06-0460	08-0700	08-2027
500mg	250mg	100mg	250mg

06-0104	racemic-4-Bromo[2.2]paracyclophane, min. 95% (1908-61-8)	500mg	See page 38
06-0460	racemic-4,12-Dibromo[2.2]paracyclophane, min. 95% (23927-40-4)	250mg	See page 39
08-0700	racemic-4,12-Dihydroxy[2.2]paracyclophane, min. 97% (612492-27-0)	100mg	See page 217
08-2027	racemic-4-Hydroxy[2.2]paracyclophane, min. 97% (157018-15-0)	250mg	See page 219

OTHER KITS - RAFT Agent Kit

96-4700

RAFT Agent Kit for controlling polymerizations at the molecular level

Sold for research purposes only under license from CSIRO.

Components also available for individual sale. Contains the following:

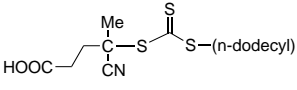
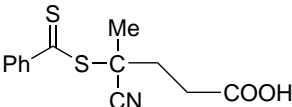
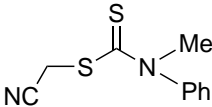
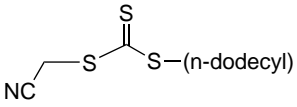
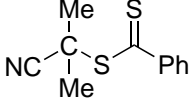
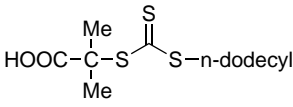
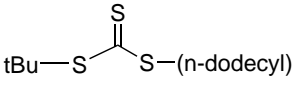
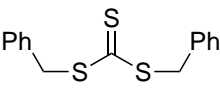
		
16-0415	16-0422	16-0423
500mg	500mg	500mg
		
16-0425	16-0430	16-0460
500mg	500mg	500mg
		
16-0610	16-0617	
500mg	500mg	

16-0415	4-Cyano-4-(dodecylsulfanylthiocarbonyl)sulfanylpropanoic acid, min. 97% (870196-80-8)	500mg	See page 424
16-0422	4-Cyano-4-(thiobenzoylthio)propanoic acid, min. 97% (201611-92-9)	500mg	See page 425
16-0423	2-Cyanomethyl-N-methyl-N-phenyldithiocarbamate, min. 97% (76926-16-4)	500mg	See page 425
16-0425	2-Cyanomethyl-S-dodecyltrithiocarbonate, min. 97% (796045-97-1)	500mg	See page 425
16-0430	2-Cyanoprop-2-yl-dithiobenzoate, min. 97% (201611-85-0)	500mg	See page 425
16-0460	2-Methyl-2-[(dodecylsulfanylthiocarbonyl)sulfanyl]propanoic acid, min. 97% (461642-78-4)	500mg	See page 426
16-0610	2-(2-Cyanoprop-2-yl)-S-dodecyltrithiocarbonate, min. 97% (870196-83-1)	500mg	See page 425
16-0617	S,S-Dibenzyltrithiocarbonate, min. 97% (26504-29-0)	500mg	See page 425

Formula Index

Formula	Description	Page
AgAsF ₆	Silver hexafluoroarsenate(V), 98.5%.....	414
AgBF ₄	Silver tetrafluoroborate, 99%.....	415
AgBr	Silver bromide (99.9%-Ag).....	414
AgCl	Silver chloride (99.9%-Ag).....	414
AgClO ₄	Silver perchlorate, anhydrous, min. 97%.....	415
	Silver perchlorate monohydrate, 99%.....	415
AgF	Silver(I) fluoride, 98%.....	414
AgF ₂	Silver(II) fluoride, 98%.....	414
AgF ₆ P	Silver hexafluorophosphate, 99%.....	414
AgF ₆ Sb	Silver hexafluoroantimonate(V), 98%.....	414
AgI	Silver iodide (99.9%-Ag).....	414
AgNO ₂	Silver nitrite, 99%.....	414
AgNO ₃	Silver nitrate (99.9995%-Ag) PURATREM	414
	Silver nitrate (99.9%-Ag) (ACS).....	414
AgO	Silver(II) oxide (99.9%-Ag).....	415
AgO ₄ Re	Silver perhenate, 99% (99.995%-Re) PURATREM.....	415
Ag ₂ CrO ₄	Silver chromate, 99%.....	414
Ag ₂ O	Silver(I) oxide, 99.4% (99.99%-Ag) PURATREM.....	414
Ag ₂ O ₂ S	Silver sulfate, 98.4% (ACS).....	415
Ag ₂ O ₃ W	Silver tungstate, 99%.....	415
Ag ₂ Te	Silver telluride (99.99%-Ag/Te) PURATREM.	415
Ag ₃ O ₄ P	Silver phosphate, 99.4%.....	415
AlBr ₃	Aluminum bromide, 99%.....	1
AlCl ₃	Aluminum chloride hexahydrate (99.999%-Al) PURATREM.....	2
	Aluminum chloride hexahydrate (99.9995%-Al) PURATREM.....	2
	Aluminum chloride, anhydrous (99.99+%-Al) PURATREM.....	1
	Aluminum chloride, anhydrous, reagent, 99%.....	1
	Aluminum chloride hexahydrate, reagent, 99%.....	2
AlCl ₃ O ₁₂	Aluminum perchlorate nonahydrate, reagent	3
AlD ₃ Li	Lithium aluminum deuteride, 98% isotopic purity.....	115
AlF ₃	Aluminum fluoride, anhydrous, 99+%.....	2
	Aluminum fluoride, anhydrous, 98.5%.....	2
AlF ₆ H ₁₂ N ₃	Ammonium hexafluoroaluminate, min. 98%..	5
AlF ₆ Na ₃	Sodium hexafluoroaluminate (99.9+%-Al)....	418
AlH ₃ O ₃	Aluminum hydroxide, dried gel, 99%.....	2
AlH ₃ Li	Lithium aluminum hydride, powder, 95%.....	115
	Lithium aluminum hydride 2.2M (10wt% ±1wt%) in 2-methyltetrahydrofuran.....	116
AlI ₃	Aluminum iodide, 95%.....	2
AlLaO ₃	Lanthanum(III) aluminum oxide.....	112
AlN	Aluminum nitride, agglomerated powder.....	2
	Aluminum nitride, degglomerated powder, high purity.....	2
	Aluminum nitride, agglomerated powder, high purity.....	2
AlN ₃ O ₉	Aluminum nitrate nonahydrate, 98+% (ACS)	2
AlNaO ₂	Sodium aluminate, contains ~8% H ₂ O (99.9%-Al).....	416
Al ₂ O ₃	Aluminum oxide (99.999%-Al) PURATREM..	2
	α-Alumina, 99.5+%.....	1
	α-Alumina trihydrate, 65% Al ₂ O ₃ , 34.8% H ₂ O, 0.15% Na ₂ O.....	1
	gamma-Alumina, min. 97%.....	1
	gamma-Alumina, low soda.....	1
	Aluminum oxide, activated, acidic, gamma, 96%.....	2
	Aluminum oxide, activated, basic, gamma, 96%.....	2
	Aluminum oxide, activated, neutral, gamma, 96%.....	2
	Aluminum oxide, 1-5 micron powder, 99+%..	2
	Aluminum oxide nanopowder.....	138
	gamma-Alumina, 1/16" spheres.....	1
	Aluminum oxide powder, surface area 6 m ² /g, 99% (Grade APS 1 micron).....	3
Al ₂ O ₃ Si ₂	Aluminum silicate dihydrate, 98%.....	3
Al ₂ O ₃ Si ₃	Aluminum sulfate octadecahydrate, 98+% (ACS).....	3
Al ₂ S ₃	Aluminum sulfide (99+%-Al) (1/4" and down pieces).....	3

Formula	Description	Page
Al ₂ Se ₃	Aluminum selenide, min. 95% (99.5%-Al)	3
AsBr ₃	Arsenic(III) bromide (99.9%-As).....	9
AsCl ₃	Arsenic(III) chloride (99.999%-As) PURATREM.....	10
	Arsenic(III) chloride, 99%.....	9
AsCr ₂	Chromium arsenide (99%-Cr).....	45
AsF ₆ Li	Lithium hexafluoroarsenate(V) (99.9+%-As) .	117
AsF ₆ Na	Sodium hexafluoroarsenate(V), 99%.....	418
AsGa	Gallium arsenide (99.9999%-Ga) PURATREM.....	67
AsI ₃	Arsenic(III) iodide, 98%.....	10
As ₂ Ca ₃ O ₈	Calcium arsenate, min. 95%.....	34
As ₂ O ₃	Arsenic(III) oxide, primary standard, 99.95+% (ACS).....	10
	Arsenic(III) oxide, tech. gr.....	10
	Arsenic(III) oxide, elec. gr. (99.999%-As) PURATREM.....	10
As ₂ O ₅	Arsenic(V) oxide (99.9+%-As).....	10
As ₂ S ₃	Arsenic(III) sulfide, fused lumps (99.999%-As) PURATREM.....	10
	Arsenic(III) sulfide (99.9%-As).....	10
As ₂ Se ₃	Arsenic(III) selenide (99.999%-As) PURATREM.....	10
As ₂ Zn ₃	Zinc arsenide (99.5%-Zn).....	452
AuBr ₃	Gold(III) bromide, anhydrous, 99% (99.9+%-Au)	75
AuBr ₄ H	Hydrogen tetrabromoaurate(III) hydrate (99.9%-Au).....	75
AuBr ₄ K	Potassium tetrabromoaurate(III) dihydrate, 99%.....	344
AuBr ₄ Na	Sodium tetrabromoaurate(III) hydrate (99.9+%-Au).....	421
AuCl	Gold(I) chloride, 97% (99.99%-Au) PURATREM.....	75
AuCl ₃	Gold(III) chloride, 99% (99.9%-Au).....	75
AuCl ₄ H	Hydrogen tetrachloroaurate(III) hydrate (99.9985%-Au) (49% Au) PURATREM.....	75
	Hydrogen tetrachloroaurate (III) hydrate (99.8%-Au) (min. 49% Au)(Chloroauric acid)	75
AuCl ₄ H ₄ N	Ammonium tetrachloroaurate(III) hydrate (99.9985%-Au) PURATREM.....	6
AuCl ₄ K	Potassium tetrachloroaurate(III) hydrate (99.99%-Au) (51%-Au) PURATREM.....	344
AuI	Gold(I) iodide, 99% (99.9+%-Au).....	75
Au ₂ O ₃	Gold(III) oxide, 99%.....	75
BBr ₃	Boron bromide, 99+%.....	25
	Boron bromide, elec. gr. (99.999%-B) PURA- TREM.....	25
BD ₃ Na	Sodium borodeuteride, 96 atom% D.....	416
BF ₃	Boron fluoride, acetic acid complex, min. 97%.....	25
	Boron fluoride, ethyl ether complex (47-48% Boron fluoride).....	25
BF ₃ H ₃ N	Ammonium tetrafluoroborate, 99%.....	7
BF ₄ K	Potassium tetrafluoroborate.....	344
BF ₄ Li	Lithium tetrafluoroborate, 98%.....	118
BF ₄ NO	Nitrosium tetrafluoroborate, min. 97%.....	204
BF ₄ NO ₂	Nitronium tetrafluoroborate, min. 97%.....	204
BF ₄ Na	Sodium tetrafluoroborate, 98%.....	421
BHF ₄	Tetrafluoroboric acid, 48% aqueous solution.	28
BH ₃	Borane, pyridine complex, min. 93%.....	25
BH ₃ O ₃	Boric acid, 99.8%.....	25
	Boric acid (99.99%-B) PURATREM.....	25
	Boric acid (99.9995%-B) PURATREM.....	25
BH ₄ K	Potassium borohydride, 98%.....	340
BH ₄ Li	Lithium borohydride, 95%.....	116
BH ₄ Na	Sodium borohydride, 98%.....	416
BLiO ₂	Lithium metaborate, anhydrous, (99.9%-Li) ..	117
	Lithium metaborate dihydrate.....	117
BN	Boron nitride, 99+%.....	26
	Boron nitride, hexagonal crystalline solid, min. 99%.....	26
BNi	Nickel boride (99%-Ni).....	174
BW	Tungsten boride (99.5%-W) (WB).....	444
B ₂ CuF ₈	Copper(II) tetrafluoroborate hydrate, 99%....	58
B ₂ F ₈ Fe	Iron(II) tetrafluoroborate, 40-45% aqueous solution.....	109

Formula Index

Formula	Description	Page
B ₂ F ₆ Ni	Nickel(II) tetrafluoroborate hexahydrate, 99%.....	176
B ₂ F ₆ Zn	Zinc tetrafluoroborate hydrate, 98%.....	454
B ₂ H ₄ O ₄	Tetrahydroxydiboron, min. 95%.....	29
B ₂ O ₃	Boron oxide (99.6%-B).....	26
	Boron oxide (99.9%-B).....	26
B ₂ Ti	Titanium boride, 99%.....	441
B ₂ Br ₃ H ₃ N ₃	B-Tribromoborazine, min. 95%.....	30
B ₂ Cl ₃ H ₃ N ₃	B-Trichloroborazine, min. 95%.....	30
B ₂ C	Boron carbide, 0.1-1.5 microns (99.9%-B) ..	25
B ₂ H ₄ N ₂ O ₇	Ammonium tetraborate tetrahydrate, 99%.....	6
B ₄ K ₂ O ₇	Potassium tetraborate tetrahydrate, 99+%....	344
B ₄ Li ₂ O ₇	Lithium tetraborate, 99%.....	118
	Lithium tetraborate (99.998%-Li).....	118
	PURATREM.....	118
B ₄ Na ₂ O ₇	Sodium tetraborate, anhydrous, 99+%.....	421
	Sodium tetraborate decahydrate, 99.54% (ACS).....	421
	Sodium tetraborate, anhydrous (99.998%-B) (50 ppm K) PURATREM.....	421
B ₆ La	Lanthanum boride (99%-La).....	112
B ₁₀ H ₁₄	Decaborane, min. 97%.....	26
B ₁₀ K ₂ O ₁₆	Potassium pentaborate octahydrate, 97%.....	343
B ₁₂ Cs ₂ H ₁₂	Cesium dodecahydrododecaborate, min. 98%.....	43
B ₁₂ H ₁₂ K ₂	Potassium dodecahydrododecaborate hydrate, min. 98%.....	341
BaBr ₂	Barium bromide, anhydrous, min. 95%.....	11
BaCl ₂	Barium chloride dihydrate (99.999%-Ba) PURATREM.....	11
	Barium chloride, anhydrous, 98+%.....	11
	Barium chloride dihydrate, 99% (ACS).....	11
BaCl ₂ O ₈	Barium perchlorate trihydrate (99.9%-Ba)....	12
BaF ₂	Barium fluoride, 99%.....	11
	Barium fluoride (99.99+%-Ba) PURATREM ..	11
BaH ₂	Barium hydride (99.5%-Ba).....	11
BaH ₂ O ₂	Barium hydroxide, anhydrous, min. 95%.....	11
	Barium hydroxide octahydrate, 98+% (ACS). ..	11
BaI ₂	Barium iodide, anhydrous, min. 97%.....	11
BaMnO ₄	Barium manganate, 90%.....	11
BaNa ₂ O ₆	Barium nitrate (99.999%-Ba) PURATREM....	12
	Barium nitrate (99.95%-Ba).....	12
	Barium nitrate, 99.5%.....	12
BaO	Barium oxide (99.5%-Ba).....	12
BaO ₂	Barium peroxide, min. 84% (99%-Ba).....	12
BaO ₃ Ti	Barium titanate, sintered lump (99%-Ba)....	12
	Barium titanate, 99%.....	12
BaS	Barium sulfide, 75%.....	12
Ba ₃ N ₂	Barium nitride (99.7%-Ba).....	12
BeO	Beryllium oxide (99.95+%-Be).....	13
BiBr ₃	Bismuth(III) bromide, 98+%.....	23
BiCl ₃	Bismuth(III) chloride, anhydrous, 99+% (99.9+%-Bi).....	23
	Bismuth(III) chloride, anhydrous (99.999%-Bi) PURATREM.....	23
BiF ₃	Bismuth(III) fluoride (99.99+%-Bi) PURATREM.....	23
	Bismuth(III) fluoride anhydrous, 99%.....	23
BiI ₃	Bismuth(III) iodide (99.999%-Bi) PURATREM.....	23
BiN ₃ O ₉	Bismuth(III) nitrate pentahydrate (99.999%-Bi) PURATREM.....	23
	Bismuth(III) nitrate pentahydrate, 98% (ACS).....	23
Bi ₂ O ₃	Bismuth(III) oxide (99.9998%-Bi) PURATREM.....	23
	Bismuth(III) oxide (99.9%-Bi).....	23
	Bismuth(III) oxide (99.999%-Bi) PURATREM.....	23
Bi ₂ O ₇ Ti ₂	Bismuth(III) titanate, 98%.....	24
Bi ₂ S ₃	Bismuth(III) sulfide (99.999%-Bi) PURATREM.....	24
	Bismuth(III) sulfide (99.9%-Bi).....	23
Bi ₂ Te ₃	Bismuth(III) telluride (99.99%-Bi) PURATREM.....	24
Br	Bromine (99.5%).....	31
BrC ₂ Cu ₆ H ₈ S	Copper(I) bromide, dimethyl sulfide complex, 99%.....	56
BrCs	Cesium bromide (99.9%-Cs).....	43

Formula	Description	Page
BrCu	Cesium bromide (99%-Cs).....	42
BrH	Copper(I) bromide, min. 98%.....	56
BrK	Hydrobromic acid, 48%.....	31
	Potassium bromide (99.999%-K) PURA-TREM.....	340
BrLi	Lithium bromide, 99+% (ACS).....	340
	Lithium bromide hydrate, 99%.....	116
	Lithium bromide, anhydrous, 99+%.....	116
	Lithium bromide (99.95%-Li) (0.2% H ₂ O).....	116
BrNa	Sodium bromide, 99+% (ACS).....	416
	Sodium bromide (99.999%-Na) PURATREM.....	416
BrRb	Rubidium bromide (99.9%-Rb).....	361
	Rubidium bromide (99%-Rb).....	361
BrTl	Thallium(I) bromide (99.999%-Tl) PURATREM.....	432
Br ₂ Ca	Calcium bromide hydrate, 98%.....	35
	Calcium bromide, anhydrous (99.5%-Ca).....	35
Br ₂ Cd	Cadmium bromide, anhydrous, 99%.....	32
Br ₂ Co	Cobalt(II) bromide hydrate.....	48
Br ₂ Cu	Copper(II) bromide, 99%.....	56
Br ₂ Fe	Iron(II) bromide hydrate.....	107
	Iron(II) bromide, anhydrous, 98%.....	107
Br ₂ Hg	Mercury(II) bromide (ACS).....	127
Br ₂ Mg	Magnesium bromide, anhydrous, 98%.....	122
	Magnesium bromide hexahydrate, 98+%.....	122
Br ₂ Mn	Manganese(II) bromide, anhydrous, min. 97% (99.9%-Mn).....	125
	Manganese(II) bromide tetrahydrate, 98%.....	125
Br ₂ Ni	Nickel(II) bromide, anhydrous (99+%-Ni).....	175
	Nickel(II) bromide hydrate.....	175
Br ₂ Pb	Lead(II) bromide, 98+%.....	114
Br ₂ Pd	Palladium(II) bromide, 99%.....	248
Br ₂ Pt	Platinum(II) bromide, 98%.....	338
Br ₂ Sn	Tin(II) bromide, 99%.....	436
Br ₂ Sr	Strontium bromide, anhydrous, 99%.....	422
Br ₂ Zn	Zinc bromide (99.9%-Zn).....	452
	Zinc bromide (99.999%-Zn) PURATREM.....	452
	Zinc bromide, 98+%.....	452
Br ₃ Ce	Cerium(III) bromide hydrate (99.9%-Ce) (REO).....	40
	Cerium(III) bromide, anhydrous (99.9%-Ce) (REO).....	40
Br ₃ Cr	Chromium(III) bromide hexahydrate.....	45
	Chromium(III) bromide, anhydrous flakes, 99%.....	45
Br ₃ Fe	Iron(III) bromide, anhydrous, 99%.....	107
Br ₃ Ga	Gallium(III) bromide, anhydrous, granular (99.999%-Ga) PURATREM.....	67
Br ₃ In	Indium(III) bromide, anhydrous (99.999%-In) PURATREM.....	80
Br ₃ Ir	Iridium(III) bromide tetrahydrate, 99%.....	92
Br ₃ La	Lanthanum(III) bromide heptahydrate (99.9%-La) (REO).....	112
Br ₃ Nd	Neodymium(III) bromide, anhydrous (99.9%-Nd) (REO).....	169
Br ₃ OP	Phosphorus oxybromide, 99%.....	320
Br ₃ P	Phosphorus(III) bromide, 97+%.....	320
Br ₃ Rh	Rhodium(III) bromide dihydrate.....	359
Br ₃ Ru	Ruthenium(III) bromide hydrate.....	398
Br ₃ Sb	Antimony(III) bromide, 99%.....	8
Br ₃ V	Vanadium(III) bromide (99.7%-V).....	445
Br ₃ C	Carbon tetrabromide, vacuum sublimed (99.998%-C) PURATREM.....	38
Br ₄ Ge	Germanium(IV) bromide (99.99+%-Ge) PURATREM.....	69
Br ₄ Hf	Hafnium(IV) bromide, anhydrous, 98% (99.7%-Hf).....	77
Br ₄ K ₂ Pd	Potassium tetrabromopalladate(II), 98%.....	344
Br ₄ K ₂ Pt	Potassium tetrabromoplatinate(II), 99%.....	344
Br ₄ Se	Selenium(IV) bromide, 99%.....	404
Br ₄ Si	Silicon(IV) bromide, 99+%.....	409
Br ₄ Sn	Tin(IV) bromide, 99%.....	436
Br ₄ Te	Tellurium(IV) bromide (99.9%-Te).....	430
Br ₄ Ti	Titanium(IV) bromide, min. 98%.....	441
Br ₄ Zr	Zirconium(IV) bromide, 98% (99+%-Zr).....	457
Br ₅ Nb	Niobium(V) bromide (99.9%-Nb).....	177
Br ₅ Ta	Tantalum(V) bromide (99.9%-Ta).....	429
Br ₆ H ₈ N ₂ O ₈	Ammonium hexabromoosmate(IV), 99%.....	5

Formula Index

Formula	Description	Page
Br ₂ K ₂ Pt	Potassium hexabromoplatinate(IV), 99%	341
CAgF ₃ O ₃ S	Silver trifluoromethanesulfonate, 99% (Silver triflate).....	415
	Silver trifluoromethanesulfonate (99.95%-Ag) (Silver triflate).....	415
CAgN	Silver cyanide, 99%.....	414
CAgNS	Silver thiocyanate, 99%.....	415
CAg ₂ O ₃	Silver carbonate (99+% -Ag)	414
CAuClO	Chlorocarbonylgold(I), min. 97%	73
CAuN	Gold(I) cyanide (99.9%-Au).....	75
CB ₄	Boron carbide, powder, 99+%	25
CBaO ₃	Barium carbonate (99.9%-Ba, Sr < .03%)	11
	Barium carbonate (99.999%-Ba) PURA-TREM	11
CBrN	Cyanogen bromide, min. 97%	193
CCaO ₃	Calcium carbonate, 98%	35
	Calcium carbonate (99.95%-Ca)	35
	Calcium carbonate (99.999%-Ca) PURA-TREM	35
CCoO ₃	Cobalt(II) carbonate hydrate (99%-Co) (Co min. 45.5%)	48
CCsO ₃	Cesium carbonate (99+% -Cs)	43
CCuN	Copper(I) cyanide, 99%.....	56
CCuNS	Copper(I) thiocyanate, 99%.....	58
CF ₃ I	Trifluoromethyl iodide, min. 97%	66
CF ₃ LiO ₃ S	Lithium trifluoromethanesulfonate, 99% (Lithium triflate).....	118
CF ₃ O ₃ STI	Thallium(I) trifluoromethanesulfonate, 99% (Thallium triflate).....	433
CFeO ₃	Iron(II) carbonate, tech. gr. (Siderite).....	107
CHF ₃ O ₃ S	Trifluoromethanesulfonic acid, 99+%	66
CHLiO ₂	Lithium formate hydrate.....	117
CHNaO ₃	Sodium hydrogen carbonate, 99.7+% (ACS)	419
CH ₂ Cl ₂ P ₂	Bis(dichlorophosphino)methane, min. 90%	258
CH ₂ Cu ₂ O ₃	Copper(II) carbonate, basic	56
CH ₂ BNNa	Sodium cyanoborohydride, 95%.....	417
CH ₂ BrMg	Methylmagnesium bromide, 3M in ether	123
CH ₂ ClMg	Methylmagnesium chloride, 3M in THF	123
CH ₂ Cl ₂ P	Methyldichlorophosphine, 97%.....	315
CH ₂ Cl ₂ Si	Trichloromethylsilane, min. 97%.....	411
CH ₂ Cl ₂ Sn	Methyltin trichloride, 98+%	435
CH ₂ Cl ₂ NP ₂	Bis(dichlorophosphino)methylamine, min. 97%	258
CH ₃ HgI	Methylmercury(II) iodide, 98+%.....	128
CH ₃ I ₃ NPb	Methylammonium triiodoplumbate(II) (40wt% solution in DMF) (99.99+% -Pb)	115
CH ₃ Li-LiBr	Methyl lithium, complexed with lithium bromide in ethyl ether (1.5M).....	119
CH ₃ LiO	Lithium methoxide, 10% in methanol.....	117
	Lithium methoxide, min. 95%	117
CH ₃ MgBr	Methylmagnesium bromide, 3.2M (35wt% ±1wt%) in 2-methyltetrahydrofuran.....	123
CH ₃ NaO	Sodium methoxide, 98+%	419
CH ₃ O ₃ Re	Methyltrioxorhenium(VII), 98%	347
CH ₃ Cl ₂ Si	Methyldichlorosilane, min. 97%	408
CH ₃ HgO	Methylmercury(II) hydroxide, ~1M aqueous solution	128
CH ₃ N ₂ Se	Selenourea, 99+%	404
CH ₃ N ₂	Methylhydrazine, 98%	202
CH ₂ B ₁₁ Cs	Cesium carborene	43
CKN	Potassium cyanide, 96% (ACS)	341
CKNS	Potassium thiocyanate, 99+% (ACS)	344
CK ₂ O ₃	Potassium carbonate (99.997%-K) PURA-TREM	341
	Potassium carbonate, 99+% (ACS).....	341
CLi ₂ O ₃	Lithium carbonate, 99%.....	116
	Lithium carbonate (99.99%-Li) PURATREM	116
	Lithium carbonate (99.999%-Li) PURATREM	116
CMgO ₃	Magnesium carbonate, basic pentahydrate, 99%	122
CMnO ₃	Manganese(II) carbonate, min. 90%	125
CMo ₂	Molybdenum carbide (99.5%-Mo)	137
CNNa	Sodium cyanide, min. 98%	417
CNa ₂ O ₃	Sodium carbonate, anhydrous, 99.5+% (ACS)	417
CNiO ₃	Nickel(II) carbonate, basic hydrate	175
CO ₃ Rb ₂	Rubidium carbonate (99%-Rb)	361
	Rubidium carbonate (99.8+% -Rb).....	361

Formula	Description	Page
CO ₃ Sr	Strontium carbonate (99.995%-Sr) PURA-TREM	422
	Strontium carbonate (low alkali and heavy metals) (99.9%-Sr)	422
	Strontium carbonate, min. 97% (contains ~1.0-2.5% barium carbonate)	422
CO ₂ Zr ₃	Zirconium(IV) carbonate, basic hydrate.....	457
CSi	Silicon carbide, -100 mesh	409
CTa	Tantalum carbide (99.5%-Ta).....	429
CTi	Titanium carbide, 99%	441
CW	Tungsten carbide (99.5%-W).....	444
CZr	Zirconium carbide (99+% -Zr).....	457
C ₂ AgF ₃ O ₂	Silver trifluoroacetate, min. 98%.....	415
C ₂ AgF ₆ NO ₃ S ₂	Silver bis(trifluoromethanesulfonyl)imide acetonitrile adduct, min. 97%	414
C ₂ AgKN ₂	Potassium silver cyanide (99.9%-Ag)	344
C ₂ AuKN ₂	Potassium dicyanoaurate(II), 99%	341
C ₂ BaF ₆ O ₆ S ₂	Barium trifluoromethanesulfonate, 99% (Barium triflate)	12
C ₂ Br ₂ ClF ₃	2-Chloro-1,2-dibromo-1,1,2-trifluoroethane, min. 97%	63
C ₂ CaF ₆ O ₆ S ₂	Calcium trifluoromethanesulfonate, min. 96% (Calcium triflate)	36
C ₂ Cl ₂ F ₂	1,1-Dichloro-2,2-difluoroethylene, min. 97%	63
C ₂ CoN ₂ S ₂	Cobalt(II) thiocyanate, min. 95%	50
C ₂ Cr ₃	Chromium carbide, 99.7%	45
C ₂ CuF ₆ O ₆ S ₂	Copper(II) trifluoromethanesulfonate, 98% (Copper triflate).....	58
C ₂ CuKN ₂	Potassium dicyanoacrylate	341
C ₂ CuO ₃	Copper(II) oxalate hemihydrate.....	57
C ₂ F ₃ LiO ₂	Lithium trifluoroacetate monohydrate, min. 97%	118
C ₂ F ₃ NaO ₂	Sodium trifluoroacetate, 97+%	421
C ₂ F ₆ I ₂	Pentafluoroethyl iodide, min. 97%	64
C ₂ F ₆ FeO ₆ S ₂	Iron(II) trifluoromethanesulfonate, 98% (Iron triflate).....	109
C ₂ F ₆ HgO ₆ S ₂	Mercury(II) trifluoromethanesulfonate, 98% (Mercury triflate)	128
C ₂ F ₆ KNO ₄ S ₂	Potassium trifluoromethanesulfonimide, min. 97%	345
C ₂ F ₆ MgO ₃ S ₂	Magnesium trifluoromethanesulfonate, min. 98% (Magnesium triflate)	123
C ₂ F ₆ NNaO ₃ S ₂	Sodium trifluoromethanesulfonimide, min. 97%	421
C ₂ F ₆ NiO ₆ S ₂	Nickel(II) trifluoromethanesulfonate, min. 98% (Nickel triflate)	176
C ₂ F ₆ O ₃ S	Trifluoromethanesulphonic anhydride, min. 97%	66
C ₂ F ₆ O ₃ S ₂ Zn	Zinc trifluoromethanesulfonate, min. 98% (Zinc triflate).....	454
C ₂ F ₆ S ₂ SnO ₆	Tin(II) trifluoromethanesulfonate, 99% (Tin triflate).....	437
C ₂ FeO ₄	Iron(II) oxalate dihydrate, min. 95%.....	108
C ₂ HF ₂ O ₂	Trifluoroacetic acid, 99%	65
C ₂ HF ₆ O ₂	Pentafluoropropionic acid, min. 97%	64
C ₂ HNa	Sodium acetylide (18% suspension in xylene)	416
C ₂ H ₂ ClF ₃ O ₂ S	2,2,2-Trifluoroethanesulphonylchloride, 97+%	65
C ₂ H ₂ CuO ₄	Copper(II) formate hydrate	57
C ₂ H ₂ F ₃ I	2,2,2-Trifluoroethyl iodide, 99%	66
C ₂ H ₂ AgO ₂	Silver acetate, 99%	414
C ₂ H ₂ Cl ₂ Si	Vinyltrichlorosilane, min. 97%.....	412
C ₂ H ₃ CsO ₂	Cesium acetate (99.9%-Cs)	42
C ₂ H ₃ CuO ₂	Copper(I) acetate, 99%	56
C ₂ H ₃ F ₃ O	2,2,2-Trifluoroethanol, 99%	66
C ₂ H ₃ KO ₂	Potassium acetate, 99+% (ACS)	340
C ₂ H ₃ LiO ₂	Lithium acetate dihydrate, 98% (99.9%-Li).....	115
C ₂ H ₃ NaO ₂	Sodium acetate, anhydrous, 99+% (ACS).....	416
C ₂ H ₃ O ₂ Rb	Rubidium acetate (99%-Rb)	361
C ₂ H ₃ O ₂ Tl	Thallium(I) acetate (99.985%-Tl) PURATREM.....	431
C ₂ H ₄ Cl ₃ KPt	Potassium trichloro(ethylene)platinate(II) monohydrate	344
C ₂ H ₄ Cl ₂ P ₂	1,2-Bis(dichlorophosphino)ethane, min. 97%	258
C ₂ H ₄ AlO ₄	Aluminum acetate, basic (boric acid adduct)	1
C ₂ H ₆ BrMg	Ethylmagnesium bromide, 3M in ether	121

Formula Index

Formula	Description	Page	Formula	Description	Page
	Ethylmagnesium bromide, 3.4M (40wt% ±1wt%) in 2-methyltetrahydrofuran.....	121	C ₃ CoNO ₄	Cobalt tricarbonyl nitrosyl.....	50
C ₂ H ₅ ClMg	Ethylmagnesium chloride, 2M in ether.....	121	C ₃ DyF ₉ O ₉ S ₃	Dysprosium(III) trifluoromethanesulfonate, min. 98% (Dysprosium triflate).....	60
C ₂ H ₅ Cl ₂ P	Ethylchlorophosphine, 98%.....	312	C ₃ Dy ₂ O ₉	Dysprosium(III) carbonate tetrahydrate (99.9%-Dy) (REO).....	60
C ₂ H ₅ Cl ₃ Ge	Ethylgermanium trichloride, min. 97%.....	69	C ₃ ErF ₉ O ₉ S ₃	Europium(III) trifluoromethanesulfonate, min. 98% (Europium triflate).....	63
C ₂ H ₅ Cl ₂ Si	Ethyltrichlorosilane, 98%.....	408	C ₃ H ₅ KO	Erbium(III) trifluoromethanesulfonate, min. 98% (Erbium triflate).....	61
C ₂ H ₅ KO	Potassium ethoxide, 95+%.....	341	C ₃ Er ₂ O ₉	Erbium(III) carbonate hydrate (99.9%-Er) (REO).....	61
C ₂ H ₅ NaO	Sodium ethoxide, 96%.....	418	C ₃ F ₆ O	Hexafluoroacetone trihydrate, min. 97%.....	64
C ₂ H ₅ OTf	Thallium(I) ethoxide, min. 95%.....	432	C ₃ F ₆ GaO ₉ S ₃	Hexafluoroacetone, anhydrous, 97%.....	64
C ₂ H ₅ O ₃ P	Vinylphosphonic acid, min. 90%.....	333	C ₃ F ₉ GdO ₉ S ₃	Gallium(III) trifluoromethanesulfonate, 98% (Gallium triflate).....	68
C ₂ H ₅ AsNaO ₂	Sodium cacodylate trihydrate, 98%.....	417	C ₃ F ₉ GdO ₉ S ₃	Gadolinium(III) trifluoromethanesulfonate, min. 98% (Gadolinium triflate).....	67
C ₂ H ₅ AuClS	Chloro(dimethylsulfide)gold(I), min. 97%.....	74	C ₃ F ₉ HoO ₉ S ₃	Holmium(III) trifluoromethanesulfonate, min. 98% (Holmium triflate).....	79
C ₂ H ₅ CaO ₂	Calcium methoxide, min. 90% (balance methanol).....	35	C ₃ F ₉ InO ₉ S ₃	Indium(III) trifluoromethanesulfonate, 99% (Indium triflate).....	80
C ₂ H ₅ Cd	Dimethylcadmium, min. 97%.....	34	C ₃ F ₉ LaO ₉ S ₃	Lanthanum(III) trifluoromethanesulfonate, min. 97% (Lanthanum triflate).....	113
	Dimethylcadmium, min. 97% (10 wt% in hexanes).....	34	C ₃ F ₉ LuO ₉ S ₃	Lutetium(III) trifluoromethanesulfonate, min. 98% (Lutetium triflate).....	119
	Dimethylcadmium, elec. gr. (99.995+%-Cd) PURATREM.....	34	C ₃ F ₉ NdO ₉ S ₃	Neodymium(III) trifluoromethanesulfonate, min. 98% (Neodymium triflate).....	170
C ₂ H ₅ CIP	Dimethylchlorophosphine, min. 97%.....	298	C ₃ F ₉ O ₉ PrS ₃	Praseodymium(III) trifluoromethanesulfonate, min. 98% (Praseodymium triflate).....	346
C ₂ H ₅ Cl ₂ Ge	Dimethylgermanium dichloride, 99%.....	69	C ₃ F ₉ O ₉ Sc	Scandium(III) trifluoromethanesulfonate, min. 98% (Scandium triflate).....	403
C ₂ H ₅ Cl ₂ Si	Dimethylchlorosilane, 99%.....	407		Scandium(III) trifluoromethanesulfonate (Scandium triflate), Microencapsulated in a Styrene Polymer [~13% Sc(SO ₂ CF ₃) ₃].....	403
C ₂ H ₅ Cl ₂ Sn	Dimethyltin dichloride, min. 95%.....	435	C ₃ F ₉ O ₉ S ₃ Sm	Samarium(III) trifluoromethanesulfonate, min. 98% (Samarium triflate).....	402
C ₂ H ₅ Cl ₂ N ₂ P ₂	1,2-Bis(dichlorophosphino)-1,2-dimethylhydrazine, min. 98%.....	258	C ₃ F ₉ O ₉ S ₃ Tb	Terbium(III) trifluoromethanesulfonate, min. 98% (Terbium triflate).....	431
C ₂ H ₅ CuO ₂	Copper(II) methoxide, 99%.....	57	C ₃ F ₉ O ₉ S ₃ Tm	Thulium(III) trifluoromethanesulfonate, min. 98% (Thulium triflate).....	433
C ₂ H ₅ LIN	Lithium dimethylamide, 95%.....	116	C ₃ F ₉ O ₉ S ₃ Y	Yttrium(III) trifluoromethanesulfonate, min. 98% (Yttrium triflate).....	450
C ₂ H ₅ NiO ₆	Nickel(II) hydroxyacetate.....	175	C ₃ F ₉ O ₉ S ₃ Yb	Ytterbium(III) trifluoromethanesulfonate hydrate (Ytterbium triflate).....	448
C ₂ H ₅ OSn	Dimethyltin oxide, min. 97%.....	435	C ₃ Gd ₂ O ₉	Gadolinium(III) carbonate hydrate (99.99%-Gd) (REO) PURATREM.....	66
C ₂ H ₅ O ₁₂ Zn ₅	Zinc carbonate hydroxide.....	452	C ₃ H ₂ BrF ₃ O	3-Bromo-1,1,1-trifluoroacetone, min. 97%.....	63
C ₂ H ₅ Se	Dimethylselenide, 99%.....	404	C ₃ H ₅ F ₆ O	Hexafluoroisopropanol, 99+%.....	64
C ₂ H ₅ Si	Dimethylpolysilane.....	407	C ₃ H ₅ BF ₃ K	Potassium allyltrifluoroborate, 99%.....	340
C ₂ H ₅ Zn	Dimethylzinc, elec. gr. (99.999%-Zn) PURATREM.....	451	C ₃ H ₅ BrMg	Allylmagnesium bromide, 0.95-1.1 M in ether.....	120
C ₂ H ₅ Zn	Dimethylzinc, min. 99% (10 wt% in hexanes) (Sure/Seal™ bottle).....	451	C ₃ H ₅ BO ₂	Cyclopropylboronic acid, min. 97%.....	26
	Dimethylzinc, 99%.....	451	C ₃ H ₅ BrMg	i-Propylmagnesium bromide, 2.9M (35wt% ±1wt%) in 2-methyltetrahydrofuran.....	124
	Dimethylzinc, elec. gr. (99.999%-Zn) PURATREM, 97-5060, contained in 50 ml electropolished Swagelok® cylinder (96-1070) for CVD/ALD.....	451	C ₃ H ₇ Al	Trimethylaluminum, min. 98% (99.999+%-Al) PURATREM.....	4
	Dimethylzinc, 99%, 97-5061, contained in 50 ml Swagelok® cylinder (96-1070) for CVD/ALD.....	451		Trimethylaluminum, elec. gr. (99.999+%-Al) PURATREM, 98-1955, contained in 50 ml electropolished Swagelok® cylinder (96-1077) for CVD/ALD.....	4
C ₂ H ₇ AsO ₂	Dimethylarsinic acid (Cacodylic acid), 98%.....	10	C ₃ H ₇ Al	Trimethylaluminum, elec. gr. (99.999+%-Al) PURATREM, 98-1955, contained in 50 ml Swagelok® cylinder (96-1070) for CVD/ALD.....	4
C ₂ H ₇ NO ₂	Ammonium acetate, anhydrous, 97+% (ACS).....	5	C ₃ H ₇ Al	Trimethylaluminum, min. 98%, 93-1360, contained in high-temp 50 ml Swagelok® cylinder (96-1071) for CVD/ALD.....	4
C ₂ H ₇ OP	Dimethylphosphine oxide, min. 97%.....	299	C ₃ H ₉ As	Trimethylarsine, 99%.....	10
C ₂ H ₇ N ₂	Ethylenediamine, 99%.....	199			
C ₂ H ₇ O ₇ P ₂	1-Hydroxyethylidene-1,1-diphosphonic acid, min. 95% HEDP.....	314			
C ₂ H ₉ P ₂	1,2-Bis(phosphino)ethane, 99%.....	279			
C ₂ H ₉ BS	Borane, dimethylsulfide complex (contains 5-6% excess dimethylsulfide).....	25			
C ₂ H ₁₀ BN	Borane, dimethylamine complex, min. 97% ..	25			
C ₂ H ₁₀ N ₂ O ₆ S ₂	Ammonium 2-aminoethane-1,1-disulfonic acid hydrate, min. 95%.....	5			
C ₂ H ₁₂ B ₁₀	o-Carborane, min. 95%.....	26			
C ₂ HgN ₂	Mercury(II) cyanide, 99%.....	127			
C ₂ N ₂ Pd	Palladium(II) cyanide, 98+%.....	248			
C ₂ N ₂ Pt	Platinum(II) cyanide, min. 98%.....	338			
C ₂ Na ₂ O ₄	Sodium oxalate, 99+%.....	419			
C ₂ NiO ₄	Nickel(II) oxalate dihydrate (99.998%-Ni) PURATREM.....	176			
	Nickel(II) oxalate dihydrate.....	176			
C ₂ O ₂ Sn	Tin(II) oxalate.....	437			
C ₂ O ₂ Sr	Strontium oxalate, min. 95%.....	423			
C ₂ AlF ₉ O ₉ S ₃	Aluminum trifluoromethanesulfonate, 99% (Aluminum triflate).....	3			
C ₂ Al ₃	Aluminum carbide, 98%.....	1			
C ₂ BiF ₉ O ₉ S ₃	Bismuth(III) trifluoromethanesulfonate, min. 98% (Bismuth triflate).....	24			
C ₃ CeF ₉ O ₉ S ₃	Cerium(III) trifluoromethanesulfonate, min. 98% (Cerium triflate).....	42			
C ₃ Ce ₂ O ₉	Cerium(III) carbonate hydrate (96%-Ce) (REO).....	40			
	Cerium(III) carbonate hydrate (99+%-Ce) (REO).....	40			

Formula Index

Formula	Description	Page	Formula	Description	Page
	Trimethylarsine, elec. gr. (99.995%-As) PURATREM.....	10	C ₄ H ₁₀ O ₆ Sn	Tin(II) tartrate hydrate, min. 95%.....	437
C ₃ H ₇ AuClIP	Chlorotrimethylphosphinegold(I), min. 98%...	74	C ₄ H ₆ BO ₂ S	2-Thiophenboronic acid, min. 97%.....	30
C ₃ H ₅ B	Trimethylborane, 98%.....	31	C ₄ H ₆ F ₃	2-Trifluoromethylpropene, min. 97%.....	66
C ₃ H ₅ BF ₄ O	Trimethylxonium tetrafluoroborate, min. 95%.....	221	C ₄ H ₆ F ₃ O ₂	Ethyltrifluoroacetate, 99%.....	63
C ₃ H ₅ BO ₃	Trimethylborate, 98%.....	31	C ₄ H ₆ BaO ₄	Barium acetate, 99% (ACS).....	11
C ₃ H ₅ B ₃ O ₆	Trimethylboroxine, min. 95%.....	31	C ₄ H ₆ CaO ₄	Calcium acetate monohydrate, 98%.....	34
C ₃ H ₅ BrGe	Trimethylgermanium bromide, 98+%.....	70	C ₄ H ₆ CdO ₄	Cadmium acetate dihydrate, 98%.....	32
C ₃ H ₅ BrSn	Trimethyltin bromide, min. 97%.....	438		Cadmium acetate, anhydrous (99.999%-Cd) PURATREM.....	32
C ₃ H ₅ ClGe	Trimethylgermanium chloride, min. 98%.....	70	C ₄ H ₆ Cl ₂ N ₂ Pd	Dichlorobis(acetonitrile)palladium(II), 99%....	236
C ₃ H ₅ ClSi	Trimethylchlorosilane, min. 97%.....	411	C ₄ H ₆ Cl ₂ Sn	Divinyltin dichloride, 98%.....	435
C ₃ H ₅ ClSn	Trimethyltin chloride, min. 98%.....	438	C ₄ H ₆ CoO ₄	Cobalt(II) acetate tetrahydrate, 98+%.....	48
C ₃ H ₅ Ga	Trimethylgallium, 99+%.....	68	C ₄ H ₆ CuO ₄	Copper(II) acetate, anhydrous, min. 97%.....	56
	Trimethylgallium, elec. gr. (99.9999%-Ga) PURATREM.....	68		Copper(II) acetate monohydrate, 98+% (ACS).....	56
	Trimethylgallium, 99+%, 31-2000, contained in 50 ml Swagelok® cylinder (96-1070) for CVD/ALD.....	68	C ₄ H ₆ FeO ₄	Iron(II) acetate, anhydrous, 97%.....	106
	Trimethylgallium, elec. gr. (99.9999%-Ga) PURATREM, 98-2000, contained in 50 ml electropolished Swagelok® cylinder (96-1077) for CVD/ALD.....	68	C ₄ H ₆ HgO ₄	Mercury(II) acetate, 98%.....	127
C ₃ H ₅ IPt	iodotrimethylplatinum(IV), 99%.....	338	C ₄ H ₆ MgO ₄	Magnesium acetate tetrahydrate, 99%.....	121
C ₃ H ₅ In	Trimethylindium, 98+% (99.9+%-In).....	80	C ₄ H ₆ MnO ₄	Manganese(II) acetate tetrahydrate, 99+%.....	125
	Trimethylindium, elec. gr. (99.999%-In) PURATREM.....	80		Manganese(II) acetate tetrahydrate (99.999%-Mn) PURATREM.....	125
	Trimethylindium, elec. gr. (99.999%-In) PURATREM, 98-2010, contained in 50 ml electropolished Swagelok® cylinder (96-1077) for CVD/ALD.....	80	C ₄ H ₆ NiO ₄	Nickel(II) acetate tetrahydrate (99.999%-Ni) PURATREM.....	174
C ₃ H ₅ O ₃ P	Trimethylphosphite, 97%.....	328		Nickel(II) acetate tetrahydrate, 98+%.....	174
	Tris(hydroxymethyl)phosphine, min. 85%.....	332	C ₄ H ₆ O ₄ Pb	Lead(II) acetate trihydrate (99.999%-Pb) PURATREM.....	114
	Tris(hydroxymethyl)phosphine, min. 95%.....	332		Lead(II) acetate trihydrate, 99+% (ACS).....	114
	Dimethylmethylphosphonate, 97%.....	299	C ₄ H ₆ O ₂ Sn	Tin(II) acetate, 99%.....	436
	Trimethylphosphite, 99%.....	328	C ₄ H ₆ O ₂ Sr	Strontium acetate, reagent.....	422
C ₃ H ₅ O ₄ P	Trimethylphosphate, min. 97%.....	328	C ₄ H ₆ O ₂ Zn	Zinc acetate dihydrate, 98+% (ACS).....	452
C ₃ H ₅ P	Trimethylphosphine, min. 98%.....	328	C ₄ H ₆ N	i-Propylisocyanide, min. 97%.....	40
	Trimethylphosphine, min. 98% (Sure/Seal™ bottle).....	328	C ₄ H ₆ AuClSi	Chloro(tetrahydrothiophene)gold(I), min. 98%.....	74
C ₃ H ₁₀ BF ₄ P	Trimethylphosphonium tetrafluoroborate, 99%.....	328	C ₄ H ₆ Cl ₂ GeO ₂	Germanium(II) chloride dioxane adduct.....	69
C ₃ H ₁₀ OSn	Trimethyltin hydroxide, 98%.....	438	C ₄ H ₆ Cl ₄ Pt ₂	Di-μ-chloro-dichlorobis(ethylene)diplati- num(II), min. 97% Zeise's dimer.....	337
C ₃ H ₁₀ OSi	Trimethylsilane, 97%.....	412	C ₄ H ₆ CIMg	n-Butylmagnesium chloride, 1.5-3.0 M in THF.....	121
C ₃ H ₁₆ BF ₄ P	Triethylphosphonium tetrafluoroborate, 99%.	327		sec-Butylmagnesium chloride, lithium chloride complex 1.2M (15wt% ±1wt%) in tetrahydrofuran.....	121
C ₃ La ₂ O ₉	Lanthanum(III) carbonate hydrate (99.9%- La) (REO).....	112	C ₄ H ₆ Cl ₂ P	t-Butyldichlorophosphine, 98%.....	282
C ₃ Nd ₂ O ₉	Neodymium(III) carbonate hydrate (99.9%- Nd) (REO).....	169	C ₄ H ₆ Cl ₂ Si	n-Butyltrichlorosilane.....	406
C ₃ O ₉ Sc ₂	Scandium(III) carbonate hydrate (99.99%- Sc) (REO) PURATREM.....	403	C ₄ H ₆ Cl ₃ Sn	n-Butyltin trichloride, min. 95%.....	434
C ₃ O ₉ Sm ₂	Samarium(III) carbonate hydrate (99.9%- Sm) (REO).....	402	C ₄ H ₆ F ₃ O ₃ SSi	Trimethylsilyl trifluoromethanesulfonate, min. 97%.....	412
C ₃ O ₉ Tb ₂	Terbium(III) carbonate hydrate (99.9%-Tb) (REO).....	431	C ₄ H ₆ F ₃ Si	Trifluoromethyltrimethylsilane, min. 97%.....	411
C ₃ O ₉ Y ₂	Yttrium(III) carbonate trihydrate (99.9%-Y) (REO).....	449	C ₄ H ₆ KO	Potassium t-butoxide, min. 98%.....	340
C ₄ BaF ₁₂ N ₂ O ₈ S ₄	Barium trifluoromethanesulfonimide, min. 97%.....	12	C ₄ H ₆ Li	n-Butyllithium, 15% in hexanes (1.6M).....	115
C ₄ BaN ₄ Pt	Barium tetracyanoplatinate(II) tetrahydrate, 99%.....	12		t-Butyllithium 16% in pentane (1-2M).....	115
C ₄ CaF ₁₂ N ₂ O ₈ S ₄	Calcium trifluoromethanesulfonimide, min. 97%.....	36	C ₄ H ₆ LiO	Lithium t-butoxide, 98+%.....	116
C ₄ Cl ₂ O ₄ Rh ₂	Chlorodicarbonylrhodium(I) dimer.....	356	C ₄ H ₆ NaO	Sodium t-butoxide, min. 98%.....	417
C ₄ F ₂ O ₃	Trifluoroacetic anhydride, min. 98%.....	65	C ₄ H ₆ O ₃ P	Vinylphosphonic acid dimethyl ester, min. 90%.....	333
C ₄ F ₆ O ₂ Pd	Palladium(II) trifluoroacetate, min. 97%.....	248	C ₄ H ₁₀ AlCl	Diethylaluminum chloride, 97%.....	3
C ₄ F ₁₂ MgN ₂ O ₈ S ₄	Magnesium bis(trifluoromethylsulfonyl)imide, min. 97%.....	122	C ₄ H ₁₀ Br ₂ CoO ₂	Cobalt(II) dibromo(1,2-dimethoxyethane), min. 98%.....	48
C ₄ F ₁₂ N ₂ O ₈ S ₄ Zn	Zinc bis(trifluoromethylsulfonyl)imide, min. 97%.....	452	C ₄ H ₁₀ Br ₂ FeO ₂	Iron(II) bromide, dimethoxyethane, min. 98%.....	107
C ₄ HF ₆ O	Perfluoro-t-butanol, min. 97%.....	65	C ₄ H ₁₀ Br ₂ NiO ₂	Nickel(II) bromide, dimethoxyethane adduct, min. 97%.....	175
C ₄ H ₃ O ₄ Ru	Acetatodicarbonylruthenium, polymer.....	363	C ₄ H ₁₀ CIP	Diethylchlorophosphine, min. 95%.....	296
C ₄ H ₄ CuO ₅	Copper(II) tartrate hydrate.....	58	C ₄ H ₁₀ Cl ₂ Ge	Diethylgermanium dichloride, min. 97%.....	69
C ₄ H ₄ F ₆ O	Hexafluoro-2-methylisopropanol, min. 97%...	64	C ₄ H ₁₀ Cl ₂ NiO ₂	Nickel(II) chloride, dimethoxyethane adduct, min. 97%.....	175
C ₄ H ₄ F ₇ N	2,2,3,3,4,4,4-Heptafluorobutylamine, min. 97%.....	63	C ₄ H ₁₀ LiN	Lithium diethylamide, 95+%.....	116
C ₄ H ₄ KNaO ₆	Potassium sodium tartrate tetrahydrate, 99%	344	C ₄ H ₁₀ MgO ₂	Magnesium ethoxide, 98%.....	122
			C ₄ H ₁₀ O ₂	(S)-(+)-1,3-Butanediol, 98+%.....	215
				(R)-(-)-1,3-Butanediol, min. 97%.....	215
			C ₄ H ₁₀ O ₂ Sn	Tin(II) ethoxide, min. 99%.....	436
				n-Butyltin hydroxide oxide hydrate, 97%.....	434
			C ₄ H ₁₀ Se ₂	Diethylselenide, min. 97%.....	404
			C ₄ H ₁₀ Zn	Diethylzinc, min. 95% (10 wt% in hexanes) (Sure/Seal™ Bottle).....	451
				Diethylzinc, min. 95%.....	451
				Diethylzinc, elec. gr. (99.9998%-Zn) PURATREM.....	451

Formula Index

Formula	Description	Page
	Diethylzinc, min. 95%, 93-3030, contained in 50 ml Swagelok® cylinder (96-1070) for CVD/ALD	451
	Diethylzinc, min. 95%, 93-3030, contained in high-temp 50 ml Swagelok® cylinder (96-1071) for CVD/ALD	451
C ₄ H ₁₁ NOS	(R)-(+)-t-Butylsulfonamide, min. 97%	424
	(S)-(-)-t-Butylsulfonamide, min. 97%	424
C ₂ H ₁₁ O ₃ P	Diethylphosphite, min. 95%	296
C ₂ H ₁₁ P	Diethylphosphine, 99%	296
	Diethylphosphine, 99% (10 wt% in hexanes) t-Butylphosphine, min. 95% TBP	282
	t-Butylphosphine, min. 95% TBP (10 wt% in hexanes)	283
C ₄ H ₁₂ BF ₄ N	Tetramethylammonium tetrafluoroborate, 97%	8
C ₄ H ₁₂ BrP	Tetramethylphosphonium bromide, 98%	325
C ₄ H ₁₂ Cl ₂ N ₂ OP	Bis(dimethylamino)phosphoryl chloride, 95+%	263
C ₄ H ₁₂ Ge	Tetramethylgermane, 99%	69
C ₂ H ₁₂ N ₂	N,N'-Dimethylethylenediamine, min. 98%	197
C ₂ H ₁₂ O ₂ Si	Methyltrimethoxysilane, min. 95%	408
C ₄ H ₁₂ O ₂ Si	Tetramethoxysilane, 98%	410
C ₂ H ₁₂ P ₂ S ₂	Tetramethylbiphosphine disulfide, 99%	324
C ₂ H ₁₂ Si	Tetramethylsilane, 99.9+% (NMR grade)	411
C ₂ H ₁₂ Sn	Tetramethyltin, 98%	436
C ₄ H ₁₃ NO	Tetramethylammonium hydroxide pentahydrate, min. 95%	169
C ₄ H ₁₃ N ₃	Diethylenetriamine, min. 95% DIEN	195
C ₄ H ₁₄ BN	Borane, t-butylamine complex, powder, min. 97%	25
C ₄ H ₁₄ OSi ₂	1,1,3,3-Tetramethyldisiloxane, 99+% TMSO (99.9999%-Si) PURATREM	411
C ₄ H ₁₆ BN	Tetramethylammonium borohydride, 95%	7
C ₄ H ₁₆ Cl ₂ N ₄ Pt	Bis(ethylenediamine)platinum(II) chloride, 99%	337
C ₄ H ₁₆ I ₂ N ₆ O ₆ Pt ₂	Di-μ-iodobis(ethylenediamine)diplatinum(II) nitrate, 99% PIP	337
C ₄ H ₂₂ B ₁₈ CoNa	Sodium cobalticarbonyl	417
C ₄ KN ₃	Potassium tricyanometanide, min. 98%	345
C ₄ K ₄ N ₄ Ni	Potassium tetracyanonickelate(II) hydrate	344
C ₄ K ₄ N ₄ Pt	Potassium tetracyanoplatinate(II) hydrate	344
C ₄ K ₂ O ₈ Pt	Potassium bis(oxalato)platinate(II) dihydrate, 99%	340
C ₂ NiO ₄	Nickel carbonyl	175
C ₂ BrMnO ₅	Manganese pentacarbonyl bromide, min. 98%	126
C ₂ BrO ₂ Re	Rhenium pentacarbonyl bromide, 98%	347
C ₆ ClO ₅ Re	Rhenium pentacarbonyl chloride, 98%	347
C ₂ F ₆ N	Pentafluoropyridine, 99%	65
C ₂ F ₁₂	Perfluoro-n-pentane, min. 98%	65
C ₃ FeO ₅	Iron pentacarbonyl, 99.5% (99.9+% -Fe)	108
	Iron pentacarbonyl, 99.5% (99.9+% -Fe) (Sure/Seal™ bottle)	109
C ₃ HF ₆ NaO ₂	Sodium hexafluoroacetylacetonate, 97%	418
C ₃ HF ₆ O ₂ Tl	Thallium(I) hexafluoroacetylacetonate, 99% (99.9%-Tl)	432
C ₆ H ₂ F ₆ O ₂	Hexafluoroacetylacetone, min. 98% HFAA	64
C ₂ H ₂ F ₆ O ₄	Hexafluoroglutaric acid, min. 97%	64
C ₂ H ₄ F ₈ O	1H,1H,5H-Octafluoro-1-pentanol, min. 98%	64
C ₂ H ₂ AuCl ₃ N	Trichloropyridinegold(III), min. 97%	76
C ₅ H ₅ Cl ₃ Ti	Cyclopentadienyltitanium trichloride, 99%	439
C ₅ H ₅ Cl ₃ Zr	Cyclopentadienylzirconium trichloride, min. 98%	455
C ₅ H ₅ Cl ₄ Mo	Cyclopentadienylmolybdenum(V) tetrachloride, min. 95%	137
C ₅ H ₅ Cl ₄ Nb	Cyclopentadienylniobium(V) tetrachloride, 98%	177
C ₃ H ₃ F ₃ O ₂	1,1,1-Trifluoroacetylacetone, min. 98%	65
C ₅ H ₅ In	Cyclopentadienylindium(I), elec. gr. (99.99+% -In) PURATREM	79
	Cyclopentadienylindium(I), elec. gr. (99.99+% -In) PURATREM, 97-3425, contained in 50 ml Swagelok® cylinder (96-1070) for CVD/ALD	79
C ₂ H ₅ Li	Lithium cyclopentadienide, 97%	116
C ₃ H ₅ NO ₄ Os	Tetraoxopyridineosmium(VIII) (~7.5% Os) polymer-bound FibreCat™	214

Formula	Description	Page
C ₄ H ₃ Na	Sodium cyclopentadienide, 2-3M in THF	417
C ₅ H ₅ Tl	Cyclopentadienylthallium, 95%	431
	Cyclopentadienylthallium, 99% (99.9%-Tl) sublimed	431
C ₆ H ₇ LiO ₂	Lithium acetylacetonate, 98+%	115
C ₂ H ₇ NaO ₂	Sodium acetylacetonate hydrate, min. 98% ..	416
C ₂ H ₇ O ₂ Tl	Thallium(I) acetylacetonate, 99%	432
C ₅ H ₉ N	n-Butylsilycyanide, 97%	38
	t-Butylsilycyanide, min. 98%	38
C ₂ H ₁₀ Si	Trimethylsilylacetylene, min. 97%	412
C ₃ H ₁₁ BN ₂	1,3-Dimethylimidazol-2-ylidene borane, min. 97%	197
C ₆ H ₁₁ Cl	neo-Pentylchloride, 98%	39
C ₈ H ₁₁ LiO	Lithium 2-methyl-2-butoxide 3.1M (40wt% ±1wt%) in heptane	117
C ₅ H ₁₁ NO	(R)-(-)-2-Pyrrolidinemethanol, 99% (D-Prolinol)	207
C ₆ H ₁₂ ClNO ₂ S	L-Cysteine ethyl ester hydrochloride, 98%	167
C ₂ H ₁₂ O ₂	(2R,4R)-(-)-2,4-Pentanediol, 99%	220
	(2S,4S)-(+)-2,4-Pentanediol, 99%	220
C ₂ H ₃ AlO	Dimethylaluminum i-propoxide, 98% (99.99+% -Al) PURATREM	3
C ₆ H ₁₄ OSi	Trimethylethoxysilane, min. 97%	411
C ₂ H ₁₄ P ₂	Bis(dimethylphosphino)methane, min. 98% ..	265
C ₅ H ₁₅ O ₅ Ta	Tantalum(V) methoxide (99.99+% -Ta) PURATREM	429
C ₆ BrF ₅	Bromopentafluorobenzene, 99%	63
C ₃ Ce ₂ O ₁₂	Cerium(III) oxalate nonahydrate (99.9%-Ce) (REO)	41
C ₆ ClF ₅	Chloropentafluorobenzene, 99%	63
C ₆ Cl ₄ O ₆ Ru ₂	Dichlorotetrachlororuthenium(II) dimer, min. 98%	393
C ₆ CoK ₃ N ₆	Potassium hexacyanocobaltate(III)	342
C ₆ CrO ₆	Chromium carbonyl, sublimed, 99%	45
	Chromium carbonyl, 98+%	45
C ₆ Eu ₂ O ₁₂	Europium(III) oxalate hydrate (99.9%-Eu) (REO)	62
C ₆ F ₆ I	Iodopentafluorobenzene, 97%	64
C ₆ F ₆	Hexafluorobenzene, min. 99%	64
C ₆ F ₆ InO ₆	Indium(III) trifluoroacetate, 99%	80
C ₆ F ₆ O ₆ Tl	Thallium(III) trifluoroacetate, tech. gr	432
C ₆ F ₁₀ O ₃	Pentafluoropropionic anhydride, min. 97% ..	65
C ₆ F ₁₈ N ₃ O ₁₂ S ₆ Sc	Scandium(III) trifluoromethanesulfonimide, min. 97%	403
C ₆ FeK ₃ N ₆	Potassium hexacyanoferrate(III), 99+% (ACS)	342
C ₆ FeK ₃ O ₁₂	Potassium tris(oxalato)ferrate(III) trihydrate ..	345
C ₆ FeK ₄ N ₆	Potassium hexacyanoferrate(II) trihydrate, 98.5+% (ACS)	342
C ₆ FeN ₆ Na ₄	Sodium hexacyanoferrate(II) decahydrate	418
C ₆ Fe ₂ O ₁₂	Iron(III) oxalate hexahydrate, tech. gr	108
C ₆ HF ₅	Pentafluorobenzene, 99%	64
C ₆ HF ₆ O	Pentafluorophenol, 99%	64
C ₆ HF ₆ S	Pentafluorothiophenol, 97%	65
C ₆ H ₂ F ₃ N	2,3,5,6-Tetrafluorothiophenol, min. 98% ..	65
C ₆ H ₂ F ₃ S	Pentafluoroaniline, 99%	64
C ₆ H ₃ Cl ₂ F ₄ NO ₃ S	2,6-Dichloro-1-fluoropyridinium triflate, 95% ..	195
	2,6-Dichloro-1-fluoropyridinium triflate, 95% ..	195
C ₆ H ₄ ClFO	2-Chloro-5-fluorophenol, min. 97%	63
C ₆ H ₄ Cl ₂ P ₂	1,2-Bis(dichlorophosphino)benzene, min. 97%	258
C ₆ H ₄ FNO ₂	o-Fluoronitrobenzene	63
C ₆ H ₄ S ₂ Zr	Tetraethialvalene, 98+% TTF	428
C ₆ H ₄ BCl ₂	Phenylboron dichloride, min. 97%	27
C ₆ H ₅ BrMg	Phenylmagnesium bromide, 3M in ether	124
	Phenylmagnesium bromide, 2.9M (45wt% ±1wt%) in 2-methyltetrahydrofuran	124
C ₆ H ₅ ClMg	Phenylmagnesium chloride, 2-3M in THF	124
C ₆ H ₅ ClSe	Phenylselenium chloride	404
C ₆ H ₄ Cl ₂ OP	Phenyldichlorophosphine oxide, min. 94% ..	318
C ₆ H ₅ Cl ₂ P	Phenyldichlorophosphine, 97%	318
	Phenyldichlorophosphine, 99%	318
C ₆ H ₄ Cl ₃ Si	Phenyltrichlorosilane, 97+%	409
C ₆ H ₄ Cl ₃ Sn	Phenyltin trichloride, min. 98%	435
C ₆ H ₅ F	Fluorobenzene, 99%	63
C ₆ H ₅ FO	o-Fluorophenol, min. 98%	63
	p-Fluorophenol, 99%	63
C ₆ H ₅ F ₄ NO ₃ S	1-Fluoropyridinium triflate, 95%	200

Formula Index

Formula	Description	Page
C ₅ H ₅ F ₃ O	1-Fluoropyridinium triflate, 95%.....	200
C ₆ H ₁₄ F ₂ O	1H,1H,2H,2H-Perfluorohexan-1-ol, 99%.....	65
C ₆ H ₅ BClO ₂	4-Chlorophenylboronic acid, min. 97%.....	26
C ₆ H ₅ BFO ₂	4-Fluorophenylboronic acid, min. 97%.....	27
C ₆ H ₅ F ₃ NO ₃ S	Pyridinium trifluoromethanesulfonate, min. 97%.....	207
C ₆ H ₅ Se	Phenylselenol, 97%.....	404
C ₆ H ₅ AsO ₃	Phenylarsonic acid, 98%.....	10
C ₆ H ₅ BO ₂	Phenylboronic acid, min. 97%.....	27
C ₆ H ₅ K	Potassium methylcyclopentadienide, 98%.....	343
C ₆ H ₅ NNa ₂ O ₆	Nitrotriacetic acid, disodium salt, 99%.....	204
C ₆ H ₅ NO ₃	N-(2-Hydroxyethyl)maleimide, 99%.....	201
C ₆ H ₅ O ₂ P	Phenylphosphinic acid, 99%.....	319
C ₆ H ₅ O ₃ P	Phenylphosphonic acid, 98%.....	319
C ₆ H ₅ P	Phenylphosphine, 99%.....	319
C ₆ H ₅ P	Phenylphosphine, 99% (Sure/Seal™ bottle). Phenylphosphine, 99% (10 wt% in hexanes)	319 319
C ₆ H ₈ P ₂	1,2-Bis(phosphino)benzene, 98%+..... 1,2-Bis(phosphino)benzene, 98%+ (10 wt% in hexanes).....	279 279
C ₆ H ₉ BiO ₆	Bismuth(III) acetate, 99%.....	23
C ₆ H ₉ CeO ₆	Cerium(III) acetate hydrate (99.999%-Ce) (REO) PURATREM..... Cerium(III) acetate hydrate (99.9%-Ce) (REO).....	40 40
C ₆ H ₉ CrO ₆	Chromium(III) acetate solution, 11.2-11.8% Cr..... Chromium(III) acetate, 97%.....	45 45
C ₆ H ₉ DyO ₆	Dysprosium(III) acetate hydrate (99.9%-Dy) (REO).....	60
C ₆ H ₉ ErO ₆	Erbium(III) acetate hydrate (99.9%-Er) (REO).....	61
C ₆ H ₉ EuO ₆	Europium(III) acetate hydrate (99.9%-Eu) (REO).....	62
C ₆ H ₉ GdO ₆	Gadolinium(III) acetate tetrahydrate (99.9%-Gd) (REO).....	66
C ₆ H ₉ HoO ₆	Holmium(III) acetate monohydrate (99.9%-Ho) (REO).....	78
C ₆ H ₉ InO ₆	Indium(III) acetate (99.99%-In) PURATREM.....	79
C ₆ H ₉ LaO ₆	Lanthanum(III) acetate hydrate (99.9%-La) (REO).....	112
C ₆ H ₉ LuO ₆	Lutetium(III) acetate hydrate (99.9%-Lu) (REO).....	119
C ₆ H ₉ MnO ₆	Manganese(III) acetate dihydrate, 98%.....	125
C ₆ H ₉ NdO ₆	Neodymium(III) acetate hydrate (99.9%-Nd) (REO).....	169
C ₆ H ₉ O ₆ Pr	Praseodymium(III) acetate hydrate (99.9%-Pr) (REO).....	345
C ₆ H ₉ O ₆ Sb	Antimony(III) acetate, 97%.....	8
C ₆ H ₉ O ₆ Sc	Scandium(III) acetate hydrate (99.9%-Sc) (REO).....	403
C ₆ H ₉ O ₆ Sm	Samarium(III) acetate hydrate (99.9%-Sm) (REO).....	402
C ₆ H ₉ O ₆ Tl	Thallium(III) acetate hydrate.....	432
C ₆ H ₉ O ₆ Tm	Thulium(III) acetate tetrahydrate (99.9%-Tm) (REO).....	433
C ₆ H ₉ O ₆ Y	Yttrium(III) acetate hydrate (99.9%-Y) (REO).....	449
C ₆ H ₉ O ₆ Yb	Ytterbium(III) acetate hydrate (99.9%-Yb) (REO).....	447
C ₆ H ₁₀ Cl ₂ Pd ₂	Allylpalladium chloride dimer, min. 98%..... Allylpalladium chloride dimer, supported on poly(ethylene glycol)polystyrene graft copolymer beads [-6% (C ₆ H ₅ PdCl) ₂].....	226 226
C ₆ H ₁₀ INS	3,4,5-Trimethylthiazolium iodide, 99%.....	428
C ₆ H ₁₁ BNaO ₆	Sodium triacetoxycorborohydride, min. 95%.....	421
C ₆ H ₁₁ Cl ₂ P	Cyclohexyldichlorophosphine, 98%.....	283
C ₆ H ₁₁ NOS	(R)-4-Isopropyl-2-oxazolidinethione, min. 98%..... (S)-4-Isopropyl-2-oxazolidinethione, min. 98%.....	201 201
C ₆ H ₁₂ BNO ₃	Triethanolamineborate, min. 95%.....	30
C ₆ H ₁₂ Cl ₂ O ₃ P	Tris(2-chloroethyl)phosphate, 97%.....	331
C ₆ H ₁₂ N ₂ O ₄ Pt	1,1-Cyclobutanedicarboxylatodiammineplatinum(II), 99% CARBOPLATIN.....	337
C ₆ H ₁₂ N ₃ P	1,3,5-Triaza-7-phosphaadamantane, min. 97% PTA.....	325
C ₆ H ₁₃ P	Cyclohexylphosphine, min. 97%.....	283

Formula	Description	Page
C ₆ H ₁₄	Cyclohexylphosphine, min. 97% (Sure/Seal™ bottle).....	283
C ₆ H ₁₄ BaO ₂	Cyclohexylphosphine, min. 97% (10 wt% in hexanes).....	283
C ₆ H ₁₄	Perfluorohexane, 98%+ (85% n-isomer).....	65
C ₆ H ₁₄ O	Barium i-propoxide, dry powder.....	12
C ₆ H ₁₄ N ₂	Barium i-propoxide (~20% in isopropanol)....	12
C ₆ H ₁₄ ClP	Di-i-propylchlorophosphine, min. 97%.....	310
C ₆ H ₁₄ N ₂	(1R,2R)-(-)-1,2-Diaminocyclohexane, 99% (R,R)-DACH..... (1S,2S)-(+)-1,2-Diaminocyclohexane, 99% (S,S)-DACH.....	193 193
C ₆ H ₁₄ O ₂	(2R,5R)-(-)-2,5-Hexanediol, 99%..... (2S,5S)-(+)-2,5-Hexanediol, 99%.....	219 219
C ₆ H ₁₄ O ₂ Sr	Strontium i-propoxide, min. 95%.....	423
C ₆ H ₁₄ O ₂ Zn	Zinc i-propoxide, 99%.....	453
C ₆ H ₁₅ Al	Triethylaluminum, min. 93%..... Triethylaluminum, elec. gr. (99.999%+Al) PURATREM.....	4 4
C ₆ H ₁₅ AlO ₃	Aluminum ethoxide, 99%.....	2
C ₆ H ₁₅ As	Triethylarsine, 99%.....	10
C ₆ H ₁₅ AuCIP	Chlorotriethylphosphinegold(I), 99%.....	74
C ₆ H ₁₅ B	Triethylborane, 98%.....	31
C ₆ H ₁₅ BO ₂	Hexylboronic acid, min. 97%.....	27
C ₆ H ₁₅ BO ₃	Triethylborate, 98.5%+.....	31
C ₆ H ₁₅ BrSn	Triethyltin bromide, min. 97%.....	437
C ₆ H ₁₅ CIGe	Triethylgermanium chloride, 98%.....	69
C ₆ H ₁₅ ClO ₃ Si	3-Chloropropyltrimethoxysilane, min. 97%....	406
C ₆ H ₁₅ CISi	t-Butyldimethylchlorosilane, min. 97%..... Triethylchlorosilane, 99%.....	406 411
C ₆ H ₁₅ CISn	Triethyltin chloride, 98%.....	437
C ₆ H ₁₅ Ga	Triethylgallium, elec. gr. (99.9999%-Ga) PURATREM.....	68
C ₆ H ₁₅ N ₃	1,4,7-Triazacyclononane, 97%.....	210
C ₆ H ₁₅ OP	Triethylphosphine oxide, 98%.....	327
C ₆ H ₁₅ O ₃ P	Triethylphosphite, 98%.....	327
C ₆ H ₁₅ O ₃ Sb	Di-i-propylphosphite, min. 98%.....	310
C ₆ H ₁₅ O ₃ P	n-Hexylphosphonic acid, min. 97% HPA.....	313
C ₆ H ₁₅ O ₃ Sb	Antimony(III) ethoxide, 99%.....	8
C ₆ H ₁₅ O ₃ P	Triethylphosphate, 99%.....	327
C ₆ H ₁₅ P	Di-i-propylphosphine, 98%..... Di-i-propylphosphine, 98% (10 wt% in hexanes)..... Triethylphosphine, 99%..... Triethylphosphine, 99% (Sure/Seal™ bottle)..... Triethylphosphine, 99% (20 wt% in ethanol)..... Triethylphosphine, 99% (10 wt% in hexanes).....	310 310 310 327 327 327
C ₆ H ₁₆ AlNaO ₄	Sodium dihydrobis(2-methoxyethoxy)aluminate, 70% in toluene.....	417
C ₆ H ₁₆ BK	Potassium triethylborohydride, 1.0M in THF, in Sure/Seal™ bottle.....	345
C ₆ H ₁₆ Cl ₂ N ₂ Pd	cis-Dichloro(N,N,N',N'-tetramethylethylenediamine)palladium(II), 99%.....	239
C ₆ H ₁₆ FeN ₁₀	Ammonium hexacyanoferrate(II) hydrate.....	5
C ₆ H ₁₆ N ₂	N,N,N',N'-Tetramethylethylenediamine, 99% TMEDA.....	209
C ₆ H ₁₆ O ₂ Si	Dimethyldiethoxysilane, 97%.....	407
C ₆ H ₁₆ P ₂	1,2-Bis(dimethylphosphino)ethane, 98% DMPE.....	265
C ₆ H ₁₆ Si	Triethylsilane, 99%.....	11
C ₆ H ₁₆ AsN ₃	Tris(dimethylamino)arsine, 99%.....	40
C ₆ H ₁₈ NNaSi ₂	Sodium hexamethyldisilazane, min. 95%.....	419
C ₆ H ₁₈ N ₃ P	Tris(dimethylamino)phosphine, min. 98% HMPT.....	331
C ₆ H ₁₈ N ₃ Sb	Tris(dimethylamino)antimony (99.99%-Sb) PURATREM.....	9
C ₆ H ₁₈ N ₄	2,2',2''-Triamino triethylamine, min. 98% TREN.....	210
C ₆ H ₁₈ SSi ₂	Bis(trimethylsilyl)sulfide, min. 98%.....	406
C ₆ H ₁₈ Si ₂	Hexamethyldisilane, 97%.....	408
C ₆ H ₁₈ Sn ₂	Hexamethylditin, 99%.....	435
C ₆ H ₁₉ NSi ₂	Hexamethyldisilazane, min. 97%.....	408
C ₆ H ₁₉ N ₃ Si	Tris(dimethylamino)silane, 99%+ 3DMAS..... Tris(dimethylamino)silane, 99%+ 3DMAS, 14-8750, contained in 50 ml Swagelok® cylinder (96-1070) for CVD/ALD.....	412 412
C ₆ H ₂₁ N ₃ Si ₃	2,2,4,4,6,6-Hexamethylchlorosilazane, 97%.....	408

Formula Index

Formula	Description	Page
$C_6H_{21}O_3P_3Pt$	Hydrido(dimethylphosphinous acid-kP) [hydrogen bis(dimethylphosphinito-kP)] platinum(II) Ghaffar-Parkins catalyst	338
$C_6H_{24}Cl_2CrN_6$	Tris(ethylenediamine)chromium(III) chloride hemiheptahydrate, min. 98%	46
$C_6K_6N_6Pt$	Potassium hexacyanoplatinate(IV), 99%	342
$C_6K_6N_6Ru$	Potassium hexacyanoruthenate(II) hydrate	342
C_6MoO_6	Molybdenum carbonyl, 98%	137
C_6N_4	Tetracyanoethylene, 98%	209
$C_6Nd_2O_{12}$	Neodymium(III) oxalate decahydrate (99.9%-Nd) (REO)	170
C_6O_6W	Tungsten carbonyl, 99% (<0.3%-Mo)	444
	Tungsten carbonyl, 99% (<0.1%-Mo)	444
	Tungsten carbonyl, 99% (99.9+%-W) sublimed	444
$C_6O_{12}Sm_2$	Samarium(III) oxalate hydrate (99.9%-Sm) (REO)	402
$C_6O_{12}Tm_2$	Thulium(III) oxalate hydrate (99.9%-Tm) (REO)	433
$C_6O_{12}Y_2$	Yttrium(III) oxalate hydrate (99.9%-Y) (REO)	449
C_7HF_5O	Pentafluorobenzaldehyde, 98%	64
C_7HF_5O	Pentafluorobenzoic acid, 99%	64
$C_7HF_{13}O_2$	Perfluoroheptanoic acid, min. 97%	65
$C_7H_2BrF_5$	Pentafluorobenzylbromide, 98+%	64
$C_7H_2ClF_4$	3-Chloro-4-fluorobenzotrifluoride, 98%	63
$C_7H_2ClF_4N$	5-Amino-2-chlorobenzotrifluoride, min. 97%	63
$C_7H_2CoO_2$	Cyclopentadienylcobalt dicarbonyl, min. 95%	51
$C_7H_2FO_2$	o-Fluorobenzoic acid, min. 97%	63
$C_7H_5LiO_2$	Lithium benzoate, 99+%	116
$C_7H_5BO_4$	3-Carboxyphenylboronic acid, min. 97%	26
	4-Carboxyphenylboronic acid, min. 97%	26
C_7H_5ClMg	Benzylmagnesium chloride, 1-2 M in THF	120
C_7H_5F	o-Fluorotoluene, 99%	63
$C_7H_5IrO_4$	Dicarbonyl(acetylacetonato)iridium(I), 98%	90
$C_7H_5N_3$	5-Methyl-1H-benzotriazole, 99%	202
$C_7H_5O_2Rh$	Dicarbonylacetylacetonato rhodium(I), 99%	357
$C_7H_5Cl_2Pd$	Dichloro(norbornadiene)palladium(II), 99%	239
$C_7H_5Cl_2Si$	Methylphenyldichlorosilane, min. 97%	408
$C_7H_5S_2$	1,2-Dimercapto-4-methylbenzene, min. 90% (Toluene-3,4-dithiol)	425
$C_7H_5BO_2$	m-Tolylboronic acid, min. 97%	30
	o-Tolylboronic acid, min. 97%	30
	p-Tolylboronic acid, min. 97%	30
$C_7H_5BO_3$	2-Methoxyphenylboronic acid, min. 97%	27
	4-Methoxyphenylboronic acid, min. 97%	27
C_7H_9NO	(R)-(+)- α -Methyl-4-pyridinemethanol, min. 98%	203
	(S)-(-)- α -Methyl-4-pyridinemethanol, min. 98%	203
$C_7H_{10}AuF_3O_2$	Dimethyl(trifluoroacetylacetonate)gold(III), 98% (99.9%-Au)	75
$C_7H_{11}N_3$	2,6-Bis(aminomethyl)pyridine, min. 85%	180
C_7H_{12}	t-Butylmethylacetylene, min. 98%	38
$C_7H_{13}AuO_2$	Dimethyl(acetylacetonate)gold(III), 98% (99.9%-Au)	74
$C_7H_{14}B_2ClF_9N_2$	1-(Chloromethyl)-4-fluoro-1,4-diazoniabicyclo[2.2.2]octane bis(tetrafluoroborate), min. 97% SelectFluor®	191
$C_7H_{14}N_2O_2S$	1,2,3-Trimethylimidazolium methyl sulfate, 98% [TriMIM] [MeSO ₄]	84
$C_7H_{15}F_3O_3SSi$	Triethylsilyl trifluoromethanesulfonate, 99% t-Butyldimethylsilyl trifluoromethanesulfonate, 98%	411
$C_7H_{16}N_2$	N,N'-Bis(1-methylethyl)methanimidamide, min. 98%	186
$C_7H_{16}O_2$	(3R,5R)-(-)-3,5-Heptanediol, 99%	219
	(3S,5S)-(+)-3,5-Heptanediol, 99%	219
$C_7H_{18}O_3Si$	Methyltriethoxysilane, 98+%	408
$C_7H_{20}N_4$	1,4,8,11-Tetraazaundecane, min. 97%	208
$C_7H_{20}Si_2$	Bis(trimethylsilyl)methane, 97%	406
$C_8Co_2O_8$	Cobalt carbonyl (Dicobalt octacarbonyl) (Stabilized with 1-5% hexanes)	48
$C_8F_4F_2O_2S$	2-Thenoyltrifluoroacetone, 99% (TTA)	65
$C_8F_{12}O_2Rh_2$	Rhodium(II) trifluoroacetate dimer, min. 95%	359
$C_8F_{15}NaO_2$	Perfluoroacetic acid, sodium salt	65
$C_8F_{16}O$	Perfluoro-2-butyltetrahydrofuran, min. 95%	65

Formula	Description	Page
$C_8F_{17}KO_3S$	Perfluorooctanesulphonic acid, potassium salt, 97%	65
$C_8F_{16}O_2S$	Perfluorooctanesulfonyl fluoride, min. 95%	65
$C_8H_4F_3NO$	p-Trifluoromethylphenylisocyanate, 99%	66
$C_8H_4F_3NO_2S_2$	2-[[Trifluoromethyl]thio]-1,1-dioxide-1,2-benzisothiazol-3(2H)-one, 97%	210
C_8H_5Cu	Copper(II) phenylacetylide, min. 97%	58
$C_8H_5F_3O$	p-Trifluoromethylbenzaldehyde, 98+%	66
$C_8H_5F_{13}O$	1H,1H,2H,2H-Perfluorooctan-1-ol, min. 97%	65
$C_8H_5MnO_3$	Cyclopentadienylmanganese tricarbonyl, 98% Cymantrene	125
$C_8H_5O_3Re$	Cyclopentadienylrhenium tricarbonyl, 99%	347
$C_8H_6N_2O_4Mo$	Bis(acetonitrile)tetracarbonylmolybdenum(0), 98%	136
$C_8H_6N_2O_5W$	Bis(acetonitrile)tetracarbonyltungsten(0)	443
$C_8H_6N_4$	2,2'-Bipyrazine, 95%	179
$C_8H_6O_6$	2,5-Dihydroxyterephthalic acid, 98%	217
C_8H_8	Cyclooctatetraene, 98% COT	38
$C_8H_8HgO_3$	Phenylmercury acetate, 97.5%	128
$C_8H_{10}AgF_6O_2P$	Trimethylphosphine(hexafluoroacetylacetonato)silver(I), 99% (99.9%-Ag)	415
$C_8H_{10}N_2Zn$	Zinc 2-methylimidazole MOF (ZIF-8)	453
$C_8H_{10}Pd$	Allyl(cyclopentadienyl)palladium(II), 98%	226
$C_8H_{11}Cl_3Hf$	i-Propylcyclopentadienylhafnium trichloride, min. 98%	77
$C_8H_{11}F_6N_3O_2S_2$	1-Ethyl-3-methylimidazolium bis(trifluoromethylsulfonyl)imide, 99% [EMIM]	82
$C_8H_{11}NO$	2-(Pyridine-2-yl)propan-2-ol, min. 95% pycal	207
$C_8H_{11}Na$	Sodium-i-propylcyclopentadienide	422
$C_8H_{11}O_2P$	Phenyldimethoxyphosphine, 98%	318
$C_8H_{11}P$	Dimethylphenylphosphine, 99%	299
$C_8H_{12}B_2CoF_4$	N,N',N''-(Tetrafluoroborato) bis[μ -(2,3-butanedionedioidoximate)]cobalt(II), min. 98%	52
$C_8H_{12}B_2F_8N_4Pd$	Tetrakis(acetonitrile)palladium(II) tetrafluoroborate, min. 98%	248
$C_8H_{12}Br_2Pd$	Dibromo(1,5-cyclooctadiene)palladium(II), 99%	236
$C_8H_{12}Br_2Pt$	Dibromo(1,5-cyclooctadiene)platinum(II), 98%	337
$C_8H_{12}Cl_2Pd$	Dichloro(1,5-cyclooctadiene)palladium(II), 99%	239
$C_8H_{12}Cl_2Pt$	Dichloro(1,5-cyclooctadiene)platinum(II), 99%	337
$C_8H_{12}Cl_2Ru$	Dichloro(1,5-cyclooctadiene)ruthenium(II) polymer, min. 97%	391
$C_8H_{12}CuF_6N_4P$	Tetrakis(acetonitrile)copper(I) hexafluorophosphate, 98+%	59
$C_8H_{12}I_2Pt$	Diiodo(1,5-cyclooctadiene)platinum(II), 99%	337
$C_8H_{12}Mo_2O_8$	Molybdenum(II) acetate dimer, 99%	137
$C_8H_{12}O_2Si$	Vinyltriacetoxysilane	112
$C_8H_{12}O_2Pb$	Lead(IV) acetate, 95%	414
$C_8H_{12}O_2Rh_2$	Rhodium(II) acetate dimer, 99%	358
$C_8H_{12}O_2Si$	Silicon(IV) acetate, min. 95%	409
$C_8H_{14}Cl_2Ni_2$	Methylalvinic chloride dimer	174
$C_8H_{14}Cl_2Pd_2$	(1-Methylallyl)palladium chloride dimer, 99%	247
	Bis(2-methylallyl)palladium chloride dimer, min. 98%	228
$C_8H_{14}CuO_4$	Copper(II) i-butylate, 99%	56
$C_8H_{14}Ni_4NiO_4$	Nickel(II) dimethylglyoxime, 99%	175
$C_8H_{14}O_2$	2,2-Dimethyl-3,5-hexanedione, min. 97%	218
$C_8H_{14}Pt$	(Trimethyl)cyclopentadienylplatinum(IV), 99%	339
$C_8H_{14}Si$	Trimethylsilylcyclopentadiene, 97% (mixture of isomers)	412
$C_8H_{15}AgO_2$	Silver 2-ethylhexanoate, 99%	414
$C_8H_{15}BF_4N_2$	1-Butyl-3-methylimidazolium tetrafluoroborate, 98% [BMIM] [BF ₄]	81
$C_8H_{15}ClN_2$	1-Butyl-3-methylimidazolium chloride, 98% [BMIM]Cl	81
$C_8H_{15}KO_2$	Potassium 2-ethylhexanoate hydrate, 95%	341
$C_8H_{15}LiO_2$	Lithium 2-ethylhexanoate, min. 98%	117
$C_8H_{15}NO_2$	N-[(1R,2R)-2-Hydroxycyclohexyl]acetamide, min. 98%	201
	N-[(1S,2S)-2-Hydroxycyclohexyl]acetamide, min. 98%	201
$C_8H_{15}NaO_2$	Sodium 2-ethylhexanoate, min. 97%	418

Formula Index

Formula	Description	Page
C ₈ H ₁₅ O ₂ Tl	Sodium 2-ethylhexanoate, 60% in water.....	418
C ₈ H ₁₆ Br ₂ FeO ₂	Thallium(I) 2-ethylhexanoate, superconductor grade (56-59% Tl).....	432
C ₈ H ₁₆ Br ₂ MnO ₂	Iron(II) bromide, Bis(tetrahydrofuran), min. 98%.....	107
C ₈ H ₁₆ Cl ₂ Rh ₂	Manganese(II) bromide, bis(tetrahydrofuran), min. 98%.....	125
C ₈ H ₁₆ Cl ₂ NbO ₂	Chlorobis(ethylene)rhodium(I) dimer, 99%....	356
C ₈ H ₁₆ Cl ₂ NiO ₂ Ti	Tetrachlorobis(tetrahydrofuran)niobium(IV) ...	177
C ₈ H ₁₆ Cl ₂ O ₂ Zr	Tetrachlorobis(tetrahydrofuran)titanium(IV), min. 97%.....	440
C ₈ H ₁₆ N ₂	Tetrachlorobis(tetrahydrofuran)zirconium.....	456
C ₈ H ₁₆ N ₂ O ₂ S	(2R,2'R)-(-)-2,2'-Bipyrrlidine, 99%.....	179
C ₈ H ₁₆ OSi ₂	(2S,2'S)-(+)-2,2'-Bipyrrlidine, 99%.....	179
C ₈ H ₁₆ OSi	1-Ethyl-3-methylimidazolium ethylsulfate, 98%.....	82
C ₈ H ₁₆ OSi	1,3-Divinyltetramethyldisiloxane, min. 97%....	407
C ₈ H ₁₆ OSi	Triethylsilylacetylene, min. 97%.....	411
C ₈ H ₁₇ CsO	Cesium 2-ethylhexoxide (0.8-1.0M in octane/toluene).....	43
C ₈ H ₁₈ AlCl	Di-n-butylaluminum chloride, 97%.....	3
C ₈ H ₁₈ ClP	Di-t-butylchlorophosphine, min. 98%.....	286
C ₈ H ₁₈ Cl ₂ Sn	Di-n-butyltin dichloride, min. 95%.....	435
C ₈ H ₁₈ KO ₄ P	Di-t-butyltin dichloride, 98%.....	435
C ₈ H ₁₈ N ₂	Potassium di-t-butylphosphate, min. 91% (contains <5% water).....	341
C ₈ H ₁₈ N ₂	trans-N,N'-Dimethyl-1,2-cyclohexanedi-amine, 98%.....	197
C ₈ H ₁₈ OSn	Di-n-butyltin oxide, 98%.....	435
C ₈ H ₁₈ O ₂	(3R,6R)-(-)-3,6-Octanediol, 99%.....	220
C ₈ H ₁₈ O ₂ Si	(3S,6S)-(+)-3,6-Octanediol, 99%.....	220
C ₈ H ₁₈ O ₃ Si	Vinyltriethoxysilane, min. 97%.....	412
C ₈ H ₁₈ O ₃ Sn ₂	Tetramethyldiacetoxystannoxane.....	436
C ₈ H ₁₈ Si ₂	Bis(trimethyltin)acetylene, min. 97%.....	406
C ₈ H ₁₈ Sn ₂	Bis(trimethyltin)acetylene, 99%.....	434
C ₈ H ₁₉ OP	Di-t-butylphosphine oxide, 98%.....	288
C ₈ H ₁₉ O ₃ P	Di-n-butylphosphite, 96%.....	290
C ₈ H ₁₉ P	n-Octylphosphonic acid, min. 97% OPA.....	318
C ₈ H ₁₉ P	Di-t-butylphosphine, min. 97%.....	288
C ₈ H ₁₉ P	Di-t-butylphosphine, min. 97% (10 wt% in hexanes).....	288
C ₈ H ₁₉ P	Di-t-butylphosphine, 98+%.....	288
C ₈ H ₁₉ P	Di-t-butylphosphine, 98+% (10 wt% in hexanes).....	288
C ₈ H ₁₉ P	2,4,4-Trimethylpentylphosphine, 99% (8% isomers).....	328
C ₈ H ₂₀ Al	Di-n-butylaluminum hydride (20% in hexanes).....	3
C ₈ H ₂₀ BNa	Sodium tetraethylborate, min. 98%.....	421
C ₈ H ₂₀ Cl ₂ N ₂ P	Bis(diethylamino)chlorophosphine, min. 97%.....	261
C ₈ H ₂₀ Cl ₂ PtS ₂	cis-Dichlorobis(diethylsulfide)platinum(II), 99%.....	337
C ₈ H ₂₀ Ge	99% (8% isomers).....	328
C ₈ H ₂₀ GeO ₄	Tetraethylgermane, 99%.....	69
C ₈ H ₂₀ HfO ₄	Germanium(IV) ethoxide (99.99+%-Ge) PURATREM.....	69
C ₈ H ₂₀ NP	Hafnium(IV) ethoxide, 99%.....	77
C ₈ H ₂₀ N ₄	2-(Di-i-propylphosphino)ethylamine, min. 97% (10 wt% in THF).....	310
C ₈ H ₂₀ N ₄	1,4,7,10-Tetraazacyclododecane, min. 98% CYCLEN.....	207
C ₈ H ₂₀ O ₃ Si	2,2-Dimethyl-3,6,9-trioxo-2-siladecane, 99+% Electrolyte Solvent ANL-1NM2.....	407
C ₈ H ₂₀ O ₄ Si	Tetraethoxysilane, min. 98% TEOS.....	410
C ₈ H ₂₀ O ₄ Ti	Titanium(IV) ethoxide (contains 5-15% isopropanol).....	442
C ₈ H ₂₀ O ₄ Zr	Titanium(IV) ethoxide (99.99%-Ti) PURATREM.....	442
C ₈ H ₂₀ O ₄ Zr	Zirconium(IV) ethoxide, 99+%.....	457
C ₈ H ₂₂ B ₃ F ₃ NP	2-(Di-i-propylphosphonium)ethylammonium bis(tetrafluoroborate), min. 97%.....	310
C ₈ H ₂₂ N ₂ Pd	cis-Dimethyl(N,N,N',N'-tetramethylethylenediamine)palladium(II), 99%.....	240
C ₈ H ₂₂ N ₂ Si	Bis(diethylamino)silane, 97% BDEAS.....	406
C ₈ H ₂₂ N ₂ Si	Bis(t-butylamino)silane, 97+% BTBAS.....	405
C ₈ H ₂₂ N ₂ Si	Bis(diethylamino)silane, 99% (99.999%-Si) BDEAS PURATREM.....	406
C ₈ H ₂₂ N ₂ Si	Bis(t-butylamino)silane, BTBAS (99.999%-Si) PURATREM.....	406

Formula	Description	Page
C ₈ H ₂₂ N ₄	1,5,8,12-Tetraazadodecane, min. 95%.....	208
C ₈ H ₂₃ N ₅	Tetraethylnepentamine, tech gr. (~50% linear, 41% branched, 5% Triethylenetetramine, 4% polyethylene polyamines) TETRAEN.....	209
C ₈ H ₂₄ BN	Tetraethylammonium borohydride.....	7
C ₈ H ₂₄ B ₂ N ₄	Tris(dimethylamino)diboron, min. 97%....	29
C ₈ H ₂₄ Cl ₂ O ₄ RuS ₂	cis-Tetrakis(dimethylsulfoxide)dichlororuthenium(II), 98%.....	399
C ₈ H ₂₄ N ₄ Sn	Tris(dimethylamino)tin(IV), 99% (99.99%-Sn) TDMASn PURATREM.....	435
C ₈ H ₂₄ N ₄ Sn	Tris(dimethylamino)tin(IV), 99% (99.99%-Sn) TDMASn PURATREM, 50-1815, contained in 50 ml Swagelok® cylinder (96-1070) for CVD/ALD.....	436
C ₈ H ₂₄ N ₄ Ti	Tetrakis(dimethylamino)titanium(IV), 99% TDMAT.....	441
C ₈ H ₂₄ N ₄ Ti	Tetrakis(dimethylamino)titanium(IV), 99% TDMAT, 93-2240, contained in 50 ml Swagelok® cylinder (96-1070) for CVD/ALD.....	441
C ₈ H ₂₄ N ₄ Ti	Tetrakis(dimethylamino)titanium(IV), 99% TDMAT, 93-2240, contained in high-temp 50 ml Swagelok® cylinder (96-1071) for CVD/ALD.....	441
C ₈ H ₂₄ N ₄ Ti	Tetrakis(dimethylamino)titanium(IV), 99% TDMAT (99.99%-Ti) PURATREM.....	441
C ₈ H ₂₄ N ₄ V	Tetrakis(dimethylamino)vanadium(IV), min. 95% TDMAV.....	445
C ₈ H ₂₄ N ₄ Zr	Tetrakis(dimethylamino)zirconium, 99% TDMAZ.....	456
C ₈ H ₂₄ N ₄ Zr	Tetrakis(dimethylamino)zirconium, 99% TDMAZ, 40-4100, contained in 50 ml Swagelok® cylinder (96-1070) for CVD/ALD.....	456
C ₈ H ₂₄ N ₄ Zr	Tetrakis(dimethylamino)zirconium(IV), 99% (99.99%-Zr) PURATREM TDMAZ.....	456
C ₈ H ₂₄ N ₄ Zr	Tetrakis(dimethylamino)zirconium(IV), 99% (99.99%-Zr) TDMAZ, 40-4115, contained in 50ml Swagelok® cylinder (96-1070) for CVD/ALD.....	456
C ₈ H ₂₄ O ₄ Si ₄	Octamethylcyclotetrasiloxane, 98%.....	408
C ₈ H ₂₈ HfN ₄	Tetrakis(dimethylamino)hafnium, 98+% (99.99+%-Hf, <0.2%-Zr) TDMAH, PURATREM, 72-8000, contained in 50ml Swagelok® cylinder (96-1071) for CVD/ALD.....	78
C ₈ K	Potassium graphite KC ₈	341
C ₈ Fe ₂ O ₃	Iron nonacarbonyl, 99%.....	108
C ₈ H ₄ F ₁₆ O	1H,1H,9H-Hexadecafluoro-1-nonanol, 95%..	64
C ₈ H ₄ O ₄ V	Cyclopentadienylvanadium tetracarbonyl, min. 97%.....	445
C ₈ H ₄ CrO ₃	Benzene chromium tricarbonyl, 98%.....	44
C ₈ H ₆ O ₆	1,3,5-Tricarboxybenzene, min. 95% (Trimesic acid) BTC.....	221
C ₈ H ₇ Cl ₃ Ti	Indenyltitanium trichloride, 99%.....	440
C ₈ H ₇ MnO ₃	Methylcyclopentadienylmanganese tricarbonyl, min. 97%.....	127
C ₈ H ₆ FeO ₃	Cyclohexadiene iron tricarbonyl, 98%.....	100
C ₈ H ₆ BO ₃ S	4-(Methylthiophenyl)boronic acid, min. 97%..	27
C ₈ H ₁₀ BCl ₃ N ₆ Ti	Hydrotris(pyrazol-1-ylborato)trichlorotitanium(IV), min. 95%.....	440
C ₉ H ₁₀ BKN ₆	Potassium hydrotris (pyrazol-1-yl)borate hydrate, 98%.....	342
C ₉ H ₁₁ Cu	Mesitylcopper(I), min. 95%.....	59
C ₉ H ₁₁ F ₄ NO ₃ S	1-Fluoro-2,4,6-trimethylpyridinium triflate	200
C ₉ H ₁₁ NO	(1S,2R)-(-)-cis-1-Aminoindan-2-ol, 98%.....	178
C ₉ H ₁₁ NO	(1R,2S)-(+)-cis-1-Aminoindan-2-ol, 98%.....	178
C ₉ H ₁₁ N ₃	(S)-(-)-2-(α-methylmethanamine)-1H-benzimidazole, min. 98% (S)-Me-BIMAH.....	203
C ₉ H ₁₁ N ₃	(R)-(+)-2-(α-methylmethanamine)-1H-benzimidazole, min. 98% (R)-Me-BIMAH.....	203
C ₉ H ₁₂ Hg ₂ O ₈	Tetrakis(acetoxymethyl)mercuric methane, min. 95%.....	128
C ₉ H ₁₂ N ₃ P	Tris(2-cyanoethyl)phosphine, min. 99%.....	331
C ₉ H ₁₃ Cl ₂ Zr	n-Butylcyclopentadienylzirconium trichloride.....	455
C ₉ H ₁₃ Li	Lithium tetramethylcyclopentadienide, min. 95%.....	118
C ₉ H ₁₄ IP	Trimethylphenylphosphonium iodide, min. 97%.....	328
C ₉ H ₁₄ O ₃ Si	Methylphenyldimethoxysilane, min. 97%.....	408
C ₉ H ₁₄ O ₃ Si	Phenyltrimethoxysilane, 97%.....	409
C ₉ H ₁₅ AlO ₉	Aluminum lactate, min. 95%.....	2

Formula Index

Formula	Description	Page
C ₄ H ₁₅ BN ₂ O ₂	4-(4,4,5,5-Tetramethyl-1,3,2-dioxaborolan-2-yl)-1H-pyrazole, min. 97%.....	30
C ₉ H ₁₅ ClPd	Chloromethyl(1,5-cyclooctadiene)-palladium(II), 99%.....	233
C ₉ H ₁₅ O ₂ Rh	Acetylacetonatobis(ethylene)rhodium(II), 99%.....	348
C ₉ H ₁₅ P	Triallylphosphine, min. 97%.....	325
C ₉ H ₁₆ ClO ₈ P	Tris(2-carboxyethyl)phosphine, hydrochloride, 99% TCEP.....	331
C ₉ H ₁₆ Pt	(Trimethyl)methylcyclopentadienylplatinum(IV), 99%.....	339
C ₉ H ₁₆ Pt	(Trimethyl)methylcyclopentadienylplatinum(IV), 99%, 78-1350, contained in 50 ml Swagelok® cylinder (96-1070) for CVD/ALD (Trimethyl)methylcyclopentadienylplatinum(IV), 99%, 78-1350, contained in 50 ml Swagelok® cylinder (96-1070) for CVD/ALD (Trimethyl)methylcyclopentadienylplatinum(IV), 99%, 78-1350, contained in 50 ml Swagelok® cylinder high temperature valve (96-1071) for CVD/ALD.....	339
C ₉ H ₁₆ Pt	(Trimethyl)methylcyclopentadienylplatinum(IV), 99% (99.999%-Pt) PURATREM.....	339
C ₉ H ₁₇ BF ₄ N ₂	1-Butyl-2,3-dimethylimidazolium tetrafluoroborate, 98% [BDIMIM][BF ₄].....	81
C ₉ H ₁₇ ClN ₂	1,3-Di-i-propylimidazolium chloride, min. 97%.....	199
C ₉ H ₁₈ Cl ₂ LiMgN	2,2,6,6-Tetramethylpiperidinylmagnesium chloride, lithium chloride complex 1.0M (18wt% ±2wt%) in toluene/tetrahydrofuran.....	124
C ₉ H ₁₈ N ₂ O ₂ S	1-Butyl-3-methylimidazolium methanesulfonate, 98% [BMIM][MeSO ₃].....	81
C ₉ H ₂₁ AlO ₃	Aluminum i-propoxide, 98+%.....	3
C ₉ H ₂₁ AlO ₃	Aluminum i-propoxide (99.99%-Al) PURATREM.....	3
C ₉ H ₂₁ BO ₃	Tri-i-propylborate, min. 98%.....	31
C ₉ H ₂₁ ClO ₃ Ti	Chlorotitanium triisopropoxide, 97%.....	439
C ₉ H ₂₁ ClSn	Tri-i-propyltin chloride, min. 98%.....	438
C ₉ H ₂₁ DyO ₃	Tri-n-propyltin chloride, 98+%.....	438
C ₉ H ₂₁ DyO ₃	Dysprosium(III) i-propoxide (99.9%-Dy) (REO).....	60
C ₉ H ₂₁ ErO ₃	Erbium(III) i-propoxide (99.9%-Er) (REO).....	61
C ₉ H ₂₁ FeO ₃	Iron(III) i-propoxide (99.9%-Fe).....	109
C ₉ H ₂₁ GdO ₃	Gadolinium(III) i-propoxide (99.9%-Gd) (REO).....	67
C ₉ H ₂₁ LaO ₃	Lanthanum(III) i-propoxide, 99% (99.9%-La) (REO).....	113
C ₉ H ₂₁ N ₃	1,4,7-Trimethyl-1,4,7-triazacyclononane, min. 97%.....	211
C ₉ H ₂₁ N ₄ P	2,8,9-Trimethyl-2,5,8,9-tetraaza-1-phosphabicyclo[3.3.3]undecane VERKADE SUPERBASE.....	329
C ₉ H ₂₁ NdO ₃	Neodymium(III) i-propoxide (99.9%-Nd) (REO).....	170
C ₉ H ₂₁ OP	Tri-n-propylphosphine oxide, min. 98%.....	330
C ₉ H ₂₁ O ₃ P	Tris(3-hydroxypropyl)phosphine, min. 80%.....	332
C ₉ H ₂₁ O ₃ Pr	Tri-i-propylphosphite, min. 94%.....	330
C ₉ H ₂₁ O ₃ Pr	Praseodymium(III) i-propoxide (99.9%-Pr) (REO).....	346
C ₉ H ₂₁ O ₃ Sm	Samarium(III) i-propoxide, min. 97% (99.9%-Sm) (REO).....	402
C ₉ H ₂₁ O ₃ Y	Yttrium(III) i-propoxide (20-25% in toluene).....	450
C ₉ H ₂₁ O ₃ Y	Yttrium(III) i-propoxide.....	450
C ₉ H ₂₁ O ₃ Yb	Ytterbium(III) i-propoxide (99.9%-Yb) (REO).....	448
C ₉ H ₂₁ O ₃ V	Vanadium(V) tri-i-propoxy oxide, 98+% VTIP.....	446
C ₉ H ₂₁ O ₆ P ₃	2,4,6-Tri-n-propyl-2,4,6-trioxo-1,3,5,2,4,6-trioxatrichlorophosphorinane (Propylphosphonic acid anhydride 50% solution in N,N-dimethylformamide) T3P.....	330
C ₉ H ₂₁ O ₆ P ₃	2,4,6-Tripropyl-2,4,6-trioxo-1,3,5,2,4,6-trioxatrichlorophosphorinane T3P (Propylphosphonic acid anhydride 50% solution in ethyl acetate).....	330
C ₉ H ₂₁ P	Di-t-butylmethylphosphine, 98+%.....	287
C ₉ H ₂₁ P	Tri-i-propylphosphine, tech. gr., min. 90%.....	329
C ₉ H ₂₁ P	Tri-i-propylphosphine, 98%.....	329
C ₉ H ₂₁ P	Tri-i-propylphosphine, 98% (Sure/Seal™ bottle).....	330
C ₉ H ₂₁ P	Tri-i-propylphosphine, 98% (10 wt% in hexanes).....	330
C ₉ H ₂₁ P	Tri-n-propylphosphine, min. 95%.....	330

Formula	Description	Page
C ₉ H ₂₂ BF ₄ P	Di-t-butylmethylphosphonium tetrafluoroborate, 99%.....	287
C ₉ H ₂₂ NP	3-(Di-i-propylphosphino)propylamine, min. 97% (10 wt% in THF).....	310
C ₉ H ₂₂ N ₄	1,4,7,10-Tetraazacyclotridecane, min. 98%.....	208
C ₉ H ₂₃ NO ₃ Si	3-Aminopropyltriethoxysilane, 98%.....	405
C ₉ H ₂₃ NO ₃ Si	3-Aminopropyltriethoxysilane, 98%, 93-1402, contained in 50 ml Swagelok® cylinder (96-1070) for CVD/ALD.....	405
C ₉ H ₂₃ NO ₃ Si	3-Aminopropyltriethoxysilane, 98%, 93-1402, contained in high-temp 50 ml Swagelok® cylinder (96-1071) for CVD/ALD.....	405
C ₉ H ₂₄ B ₂ F ₈ NP	3-(Di-i-propylphosphonium)propylammonium bis(tetrafluoroborate).....	310
C ₉ H ₂₄ N ₄	1,5,9,13-Tetraazatridecane, min. 97%.....	208
C ₉ H ₂₇ BO ₂ Si ₃	Tris(trimethylsilyloxy)borate, min. 97%.....	31
C ₉ H ₂₇ NSi ₃	Nonamethyltrisilazane, 98%.....	408
C ₉ H ₂₇ PSi ₃	Tris(trimethylsilyl)phosphine, min. 98%.....	332
C ₉ H ₂₇ PSi ₃	Tris(trimethylsilyl)phosphine, min. 98% (10 wt% in hexanes).....	332
C ₁₀ F ₁₈	Perfluorodecalin, min. 95%.....	65
C ₁₀ H ₂ BaF ₁₂ O ₄	Barium hexafluoroacetylacetonate.....	11
C ₁₀ H ₂ CaF ₁₂ O ₄	Calcium hexafluoroacetylacetonate dihydrate, 97%.....	35
C ₁₀ H ₂ CuF ₁₂	Copper(II) hexafluoroacetylacetonate, anhydrous, elec. gr. (99.99+-Cu) PURATREM.....	57
C ₁₀ H ₂ CuF ₁₂ O ₄	Copper(II) hexafluoroacetylacetonate hydrate, elec. gr. (99.99+-Cu) PURATREM.....	57
C ₁₀ H ₂ F ₁₂ MgO ₄	Copper(II) hexafluoroacetylacetonate hydrate.....	57
C ₁₀ H ₂ F ₁₂ MgO ₄	Magnesium hexafluoroacetylacetonate dihydrate, min. 97%.....	122
C ₁₀ H ₂ F ₁₂ NiO ₄	Nickel(II) hexafluoroacetylacetonate hydrate, 98%.....	175
C ₁₀ H ₂ F ₁₂ O ₄ Pb	Lead(II) hexafluoroacetylacetonate, min. 98%.....	114
C ₁₀ H ₂ F ₁₂ O ₄ Pd	Palladium(II) hexafluoroacetylacetonate, min. 95%.....	248
C ₁₀ H ₂ F ₁₂ O ₄ Pt	Platinum(II) hexafluoroacetylacetonate, 98% (99.9%-Pt).....	338
C ₁₀ H ₂ F ₁₂ O ₄ Sn	Tin(II) hexafluoroacetylacetonate (99.9%-Sn).....	436
C ₁₀ H ₂ F ₁₂ O ₄ Sr	Strontium hexafluoroacetylacetonate.....	423
C ₁₀ H ₂ F ₁₂ O ₄ Zn	Zinc hexafluoroacetylacetonate hydrate, min. 98%.....	452
C ₁₀ H ₂ F ₁₇ I	1H,1H,2H,2H-Perfluorodecylidide, 97%.....	65
C ₁₀ H ₅ F ₁₇ O	1H,1H,2H,2H-Perfluorodecan-1-ol, min. 97%.....	65
C ₁₀ H ₇ F ₃ O ₂	Benzoyl-1,1,1-trifluoroacetone, 98%.....	63
C ₁₀ H ₈ Br ₂ Fe	1,1'-Dibromoferrrocene, 97%.....	100
C ₁₀ H ₈ Cl ₂ FeP ₂	1,1'-Bis(dichlorophosphino)ferrrocene, 98%.....	95
C ₁₀ H ₈ CuF ₆ O ₄	Copper(II) trifluoroacetylacetonate, 97+%.....	58
C ₁₀ H ₈ F ₆ MgO ₄	Magnesium trifluoroacetylacetonate dihydrate, min. 98%.....	123
C ₁₀ H ₈ F ₆ NiO ₄	Nickel(II) trifluoroacetylacetonate dihydrate, 98%.....	176
C ₁₀ H ₈ MoO ₃	Cycloheptatriene molybdenum tricarbonyl, 99%.....	136
C ₁₀ H ₈ N ₂	2,2'-Bipyridine, 99+% BIPY.....	179
C ₁₀ H ₈ BO ₃	1-Naphthylboronic acid, min. 97%.....	27
C ₁₀ H ₈ BrFe	Bromoferrrocene, 97%.....	99
C ₁₀ H ₈ Cl ₂ FeP	Dichlorophosphinoferrrocene, 98%.....	101
C ₁₀ H ₁₀ Cl ₂ Hf	Bis(cyclopentadienyl)hafnium dichloride, min. 98% (Hafnocene dichloride).....	76
C ₁₀ H ₁₀ Cl ₂ Mo	Bis(cyclopentadienyl)molybdenum dichloride, 99%.....	136
C ₁₀ H ₁₀ Cl ₂ N ₂ Pt	cis-Dichlorobis(pyridine)platinum(II), 99%.....	337
C ₁₀ H ₁₀ Cl ₂ Ti	Bis(cyclopentadienyl)titanium dichloride, 99+% (Titanocene dichloride).....	439
C ₁₀ H ₁₀ Cl ₂ V	Bis(cyclopentadienyl)vanadium dichloride (Vanadocene dichloride), 95%.....	445
C ₁₀ H ₁₀ Cl ₂ W	Bis(cyclopentadienyl)tungsten dichloride, 99%.....	443
C ₁₀ H ₁₀ Cl ₂ Zr	Bis(cyclopentadienyl)zirconium dichloride, 99% (Zirconocene dichloride).....	455
C ₁₀ H ₁₀ Co	Bis(cyclopentadienyl)cobalt(II), min. 98%.....	47
C ₁₀ H ₁₀ CoF ₆ P	Cobalt(II) hexafluorophosphate, 98%.....	50
C ₁₀ H ₁₀ Cr	Bis(cyclopentadienyl)chromium, min. 95%, sublimed (Chromocene).....	44

Formula Index

Formula	Description	Page	Formula	Description	Page
C ₁₀ H ₁₀ Fe	Bis(cyclopentadienyl)iron, 98% (Ferrocene)..	94	C ₁₀ H ₁₅ Li	Lithium pentamethylcyclopentadienide, min. 98%	118
Bis(cyclopentadienyl)iron, 99% (Ferrocene)..	94	C ₁₀ H ₁₅ N ₃ O	(2S)-2-Amino-3-methyl-N-2-pyridinylbutanamide, min. 98%	179	
C ₁₀ H ₁₀ Mg	Bis(cyclopentadienyl)magnesium (99.9%-Mg)	120	(2R)-2-Amino-3-methyl-N-2-pyridinylbutanamide, min. 98%	178	
Bis(cyclopentadienyl)magnesium (99.99%-Mg) PURATREM	120	C ₁₀ H ₁₆	Pentamethylcyclopentadiene, min. 98%	39	
C ₁₀ H ₁₀ Mn	Bis(cyclopentadienyl)manganese, 98+% (Manganocene)	124	C ₁₀ H ₁₆ N ₂	1,3-Bis(dimethylamino)benzene, 98%	182
Bis(cyclopentadienyl)manganese, 98+%, 25-0200, contained in 50 ml Swagelok® cylinder (96-1070) for CVD/ALD	124	C ₁₀ H ₁₆ N ₂ O ₈	Ethylenediaminetetraacetic acid, 99+%	199	
C ₁₀ H ₁₀ N ₂	3-Methyl-5-phenyl-1H-pyrazole, 99%	203	C ₁₀ H ₁₆ O ₂	2-Isobutyrylcyclohexanone, 96% (-96% enol form)	219
C ₁₀ H ₁₀ N ₂ S ₂	2-Cyanomethyl-N-methyl-N-phenylthiocarbamate, min. 97%	425	C ₁₀ H ₁₆ O ₆ P ₂	1,2-Bis(dimethoxyphosphoryl)benzene, 99%	263
C ₁₀ H ₁₀ N ₆	Tris(pyrazol-1-yl)methane, min. 98%	212	C ₁₀ H ₁₇ AgO ₂	Silver cyclohexanebutyrate (AAS)	414
C ₁₀ H ₁₀ Ni	Bis(cyclopentadienyl)nickel, 99% (Nickelocene)	171	C ₁₀ H ₁₇ NO ₃ Si	2,2',2''-Nitrioltris(ethanolato)(buta-1,3-dien-2-yl)silane, min. 98%	408
C ₁₀ H ₁₀ O ₂ S ₂	2-(Thiobenzoylthio)propionic acid, min. 97%	428	C ₁₀ H ₁₇ O ₃ P	2,4,6-Trioxa-1,3,5,7-tetramethyl-8-phosphaadamantane (-32% in xylene)	329
C ₁₀ H ₁₀ O ₄	1,4-Phenylenediacetic acid, 97%	220	C ₁₀ H ₁₈ O ₄ Pd	Palladium(II) trimethylacetate, min. 98%	248
C ₁₀ H ₁₀ Os	Bis(cyclopentadienyl)osmium, 99% (99.9%-Os) (Osmocene)	213	C ₁₀ H ₁₈ Pt	Dimethyl(1,5-cyclooctadiene)platinum(II), 99%	338
C ₁₀ H ₁₀ Ru	Bis(cyclopentadienyl)ruthenium, 99% (99.9%-Ru) (Ruthenocene)	364	C ₁₀ H ₁₈ AgO ₂	Silver neodecanoate, min. 97%	414
C ₁₀ H ₁₀ V	Bis(cyclopentadienyl)vanadium, sublimed, 95% (Vanadocene)	445	C ₁₀ H ₁₉ BF ₄ N ₂	1-Hexyl-3-methylimidazolium tetrafluoroborate, 98% [HMIM][BF ₄]	82
C ₁₀ H ₁₁ ClZr	Bis(cyclopentadienyl)zirconium chloride hydride (Schwartz's Reagent), 95%	454	C ₁₀ H ₁₉ NO ₃ S	(4S)-4-i-Propyl-1,2,3-oxathiazolidine-2,2-dioxide-3-carboxylic acid t-butyl ester, min. 97%	427
C ₁₀ H ₁₁ F ₇ O ₂	6,6,7,7,8,8,8-Heptafluoro-2,2-dimethyl-3,5-octanedione, 98+% HFOD	64	C ₁₀ H ₁₉ P	(4R)-4-i-Propyl-1,2,3-oxathiazolidine-2,2-dioxide-3-carboxylic acid t-butyl ester, min. 97%	427
C ₁₀ H ₁₁ F ₉ N ₃ O ₅ S ₂	1-Ethyl-3-methylimidazolium bis(pentafluoroethylsulfonfyl)imide, 99% [EMIBet]	82	C ₁₀ H ₂₀ B ₂ O ₄	Dicyclopentylphosphine, 97+%	295
C ₁₀ H ₁₁ FeP	Phosphinoferrocene, 98%	110	C ₁₀ H ₂₀ O ₅	Dicyclopentylphosphine, 97+% (10 wt% in hexanes)	295
C ₁₀ H ₁₂ Cl ₂ Pt	Dichloro(dicyclopentadienyl)platinum(II), 99%	337	C ₁₀ H ₂₀ O ₂	Bis(neopentylglycolato)diboron, min. 97%	24
C ₁₀ H ₁₂ N ₂ Na ₂ O ₈	Ethylenediaminetetraacetic acid, tetrasodium salt tetrahydrate, 99+%	200	C ₁₀ H ₂₀ O ₅	neo-Decanoic acid, prime grade	38
C ₁₀ H ₁₂ BaO ₄	Barium acetylacetonate hydrate	11	C ₁₀ H ₂₀ O ₅	15-Crown-5, 98%	215
C ₁₀ H ₁₂ CaO ₄	Calcium acetylacetonate hydrate	34	C ₁₀ H ₂₀ O ₆ P ₂	Bis(diethoxyphosphoryl)acetylene, 99%	261
C ₁₀ H ₁₂ CdO ₄	Cadmium acetylacetonate, 98%	32	C ₁₀ H ₂₃ O ₃ P ₂	n-Decylphosphonic acid, min. 97%	284
C ₁₀ H ₁₂ ClP	Chloro(t-butyl)phenylphosphine, 97%	283	C ₁₀ H ₂₄ CuN ₂ O ₂	Bis(dimethylamino-2-propoxy)copper(II), min. 97% Cu(dmap)	55
C ₁₀ H ₁₂ CoO ₄	Cobalt(II) acetylacetonate hydrate	48	C ₁₀ H ₂₄ NP	2-(Di-t-butylphosphino)ethylamine, min. 97% (10 wt% in THF)	289
C ₁₀ H ₁₂ CuO ₄	Copper(II) acetylacetonate, 98+%	56	C ₁₀ H ₂₄ N ₂ NiO ₂	Bis[1-(N,N-dimethylamino)-2-propanolato]nickel(II), 99% Ni(DMAP)	172
C ₁₀ H ₁₂ K ₂ Na ₂ O ₈	Ethylenediaminetetraacetic acid dipotassium salt dihydrate, 99%	199	C ₁₀ H ₂₄ N ₄	1,4,8,11-Tetraazacyclotetradecane, min. 98% CYCLAM	208
C ₁₀ H ₁₄ MgO ₄	Magnesium acetylacetonate, anhydrous, 98%	122	C ₁₀ H ₂₄ O ₄ Si	2,2-Dimethyl-3,6,9,12-tetraoxa-2-silatridecane, 99+% Electrolyte Solvent ANL-1NM3	407
C ₁₀ H ₁₄ MnO ₄	Manganese(II) acetylacetonate, 95%	125	C ₁₀ H ₂₄ P ₂	1,2-Bis(diethylphosphino)ethane, 98%	261
C ₁₀ H ₁₄ MoO ₆	Molybdenum(V) dioxide bis(acetylacetonate), min. 95%	138	C ₁₀ H ₂₅ B ₂ F ₃ NP	(2-Ammonioethyl)di-t-butylphosphonium bis(tetrafluoroborate), min. 97%	250
C ₁₀ H ₁₄ N ₂ Na ₂ O ₈	Ethylenediaminetetraacetic acid, disodium salt, dihydrate, 99+%	199	C ₁₀ H ₂₆ NbO ₅	Niobium(V) ethoxide (99.9%-Nb)	177
C ₁₀ H ₁₄ NiO ₄	Nickel(II) acetylacetonate hydrate	174	C ₁₀ H ₂₅ O ₅ Ta	Tantalum(V) ethoxide (99.99+%-Ta) PURATREM	429
C ₁₀ H ₁₄ O ₂ Pb	Lead(II) acetylacetonate, min. 95%	114	C ₁₀ H ₂₅ O ₅ Ta	Tantalum(V) ethoxide (99.999%-Ta) PURATREM	429
C ₁₀ H ₁₄ O ₂ Pd	Palladium(II) acetylacetonate, 99%	247	C ₁₀ H ₂₇ N ₃ Ta	t-Butylimidotris(dimethylamino) tantalum(V), min. 98%	429
C ₁₀ H ₁₄ O ₂ Pt	Platinum(II) acetylacetonate, 98%	338	C ₁₀ H ₂₈ Si ₃	t-Butylimidotris(dimethylamino)tantalum(V), min. 98%, 73-0700, contained in 50 ml Swagelok® cylinder (96-1070) for CVD/ALD	429
C ₁₀ H ₁₄ O ₂ Sn	Tin(II) acetylacetonate, min. 98%	436	C ₁₀ H ₂₈ N ₂ Si ₃	Tris(trimethylsilyl)methane, min. 97%	412
C ₁₀ H ₁₄ O ₂ Sr	Strontium acetylacetonate hydrate, 99%	422	C ₁₀ H ₃₀ N ₅ Ta	Pentakis(dimethylamino)tantalum(V), 99% ..	429
C ₁₀ H ₁₄ O ₂ Zn	Zinc acetylacetonate hydrate, 98%	452	C ₁₀ H ₃₀ NbN ₅	Pentakis(dimethylamino)niobium(V), 99%	177
C ₁₀ H ₁₄ O ₃ Ti	Titanium(IV) oxide bis(acetylacetonate), min. 95%	442	C ₁₀ Mn ₂ O ₁₀	Manganese carbonyl, 98%	126
C ₁₀ H ₁₄ O ₅ V	Vanadium(IV) bis(acetylacetonato)oxide, 98% (Vanadyl acetylacetonate)	445	C ₁₀ O ₁₀ Re ₂	Rhenium carbonyl, 98%	347
C ₁₀ H ₁₆ BO ₃	3-(4,4,5,5-Tetramethyl-1,3,2-dioxaborolan-2-yl)furan, min. 97%	29	C ₁₁ H ₇ BF ₅ N ₃	6,7-Dihydro-2-pentafluorophenyl-5H-pyrrolo[2,1-c]-1,2,4-triazolium tetrafluoroborate, min. 98%	197
C ₁₀ H ₁₆ Cl ₂ Ru	Dichloro(pentamethylcyclopentadienyl)ruthenium(III) polymer	392	C ₁₁ H ₈ CuF ₃ N ₃ S	Trifluoromethylthiolato(2,2-bipyridine)copper(II), 97%	59
C ₁₀ H ₁₆ Cl ₃ Hf	Pentamethylcyclopentadienylhafnium trichloride, min. 98%	77	C ₁₁ H ₈ FeO ₃	Cyclooctatetraene iron tricarbonyl, 98%	100
C ₁₀ H ₁₆ Cl ₃ Ti	Pentamethylcyclopentadienyltitanium trichloride, 98%	440	C ₁₁ H ₉ N	2-Phenylpyridine, 95%	205
C ₁₀ H ₁₆ Cl ₃ Zr	Pentamethylcyclopentadienylzirconium trichloride, 99%	456	C ₁₁ H ₁₀ FeO	Ferrocene carboxaldehyde, min. 98%	105
C ₁₀ H ₁₆ Cl ₄ Ta	Pentamethylcyclopentadienyltantalum tetrachloride, 98%	429	C ₁₁ H ₁₀ FeO ₂	Ferrocene monocarboxylic acid, min. 97%	105
C ₁₀ H ₁₆ F ₈ N ₃ O ₅ S ₂	1,2-Dimethyl-3-propylimidazolium bis(trifluoromethylsulfonyl)imide, 99% [DMPIIm]	82	C ₁₁ H ₁₁ NS ₂	2-Cyanoprop-2-yl-dithiobenzoate, min. 97% ..	425
			C ₁₁ H ₁₁ O ₃ Re	i-Propylcyclopentadienylrhenium tricarbonyl, min. 97%	347
			C ₁₁ H ₁₂ ClN ₃	6,7-Dihydro-2-phenyl-5H-pyrrolo[2,1-c]-1,2,4-triazolium chloride, min. 98%	197

Formula Index

Formula	Description	Page	Formula	Description	Page
C ₁₁ H ₁₂ Cu ₂ N ₃	(Hexamethylenetetramine)penta[copper(I) cyanide], 98% MOF	58	C ₁₂ H ₈ ClF ₂ P	Bis(4-fluorophenyl) chlorophosphine, min. 98%	277
C ₁₁ H ₁₂ FeO	Hydroxymethylferrocene, 99%	106	C ₁₂ H ₃ F ₃ N	2-[4-(Trifluoromethyl)phenyl]pyridine, 95%	210
C ₁₁ H ₁₄ F ₆ N ₂ O ₂ S ₂	N-Propyl-3-methylpyridinium bis(trifluoromethylsulfonyl)imide, 99% [PMPIm]	83	C ₁₂ H ₈ N ₂	1,10-Phenanthroline, anhydrous, 99%	205
C ₁₁ H ₁₄ F ₃ N ₃ PRu	Tris(acetonitrile)cyclopentadienylruthenium(II) hexafluorophosphate, min. 98%	400	C ₁₂ H ₈ N ₂ O ₄	4,4'-Dicarboxy-2,2'-bipyridine, 98%	195
C ₁₁ H ₁₂ S ₂	2-Methyl-2-propylbenzodithiolate	426	C ₁₂ H ₈ O ₃	2,6-Naphthalenedicarboxylic acid, min. 98%	219
C ₁₁ H ₁₂ N ₃	(S)-(-)-2-(α-(i-propyl)methanamine)-1H-benzimidazole, min. 98% (S)-i-Pr-BIMAH	206	C ₁₂ H ₉ F ₂ N	2-(2,4-Difluorophenyl)-5-methylpyridine, 95%	196
	(R)-(+)-2-(α-(i-propyl)methanamine)-1H-benzimidazole, min. 98% (R)-i-Pr-BIMAH	206	C ₁₂ H ₃ O ₃ P	Tri-2-furylphosphine, 98+%	327
C ₁₁ H ₁₇ MoN ₃ O ₆	Oxidoperoxy(pyridine)(1,3-dimethyl-3,4,5,6-tetrahydro-2(1H)-pyrimidinone) molybdenum(IV), min. 95%	138	C ₁₂ H ₉ P	5H-Benzo[<i>b</i>]phosphindole, 99%	251
C ₁₁ H ₁₀ AgF ₃ O ₅ P	Triethoxyphosphine(trifluoroacetylacetonate) silver(I), min. 98%	415	C ₁₂ H ₁₀ ClOP	Diphenylphosphonic chloride, 98%	303
C ₁₁ H ₁₀ AgO ₂	2,2,6,6-Tetramethyl-3,5-heptanedionato silver(I) (99.9%-Ag) [Ag(TMHD)]	415	C ₁₂ H ₁₀ CIP	Diphenylchlorophosphine, min. 95%	302
C ₁₁ H ₁₀ CsO ₂	2,2,6,6-Tetramethyl-3,5-heptanedionato cesium [Cs(TMHD)]	44	C ₁₂ H ₁₀ Cl ₂ Sn	Diphenylchlorosilane, min. 97%	407
C ₁₁ H ₁₀ KO ₂	2,2,6,6-Tetramethyl-3,5-heptanedionato potassium, min. 95% [K(TMHD)]	345	C ₁₂ H ₁₀ Co ₂ O ₆	Diphenyltitanium dichloride, 96%	435
C ₁₁ H ₁₀ LiO ₂	2,2,6,6-Tetramethyl-3,5-heptanedionato lithium, 98+% [Li(TMHD)]	119	C ₁₂ H ₁₀ Co ₃ O ₁₄	(3,3-Dimethyl-1-butene)dibocobalt hexacarbonyl, 98%	51
C ₁₁ H ₁₀ NO ₃ S	(S,R)-Hexahydro-3H-1,2,3-benzoxathiazole-2,2-dioxide-3-carboxylic acid t-butyl ester, min. 97%	426	C ₁₂ H ₁₀ FeO ₄	Cobalt(II) citrate hydrate	48
	(R,S)-Hexahydro-3H-1,2,3-benzoxathiazole-2,2-dioxide-3-carboxylic acid t-butyl ester, min. 97%	426	C ₁₂ H ₁₀ FeO ₄	1,1'-Ferrocene dicarboxylic acid, min. 96%	105
C ₁₁ H ₁₀ O ₂ Rb	2,2,6,6-Tetramethyl-3,5-heptanedionato rubidium [Rb(TMHD)]	362	C ₁₂ H ₁₀ N ₄	1,4-Di(4'-pyrazolyl)benzene, min. 97%	199
C ₁₁ H ₁₀ O ₂ Tl	2,2,6,6-Tetramethyl-3,5-heptanedionatothallium(I), 99% [Tl(TMHD)]	431	C ₁₂ H ₁₀ OSn	H ₂ BDP	199
C ₁₁ H ₂₀ AuClIN ₂	Chloro[1,3-bis(t-butyl)-2H-imidazol-2-ylidene]gold(I), 98%	73	C ₁₂ H ₁₀ O ₂ Ti	Diphenyltin oxide, 98%	435
C ₁₁ H ₂₀ CuP	Cyclopentadienyl(triethylphosphine) copper(I), min. 98%	58	C ₁₂ H ₁₀ O ₂ Ti	Bis(cyclopentadienyl)dicarbonyl titanium(II), min. 98%	439
C ₁₁ H ₂₀ N ₂	1,3-Di-t-butylimidazol-2-ylidene, min. 98%	195	C ₁₂ H ₁₀ O ₁₄ Pb ₃	Lead(II) citrate trihydrate, min. 97%	114
C ₁₁ H ₂₀ O ₂	2,2,6,6-Tetramethylheptane-3,5-dione, 98% TMHD	221	C ₁₂ H ₁₀ SSn	Diphenyltin sulfide, 99%	435
C ₁₁ H ₂₁ BF ₄ N ₂	1,3-Bis(t-butyl)imidazolium tetrafluoroborate, min. 97% tBuHBF ₄	181	C ₁₂ H ₁₀ Se	Diphenylselenide	404
C ₁₁ H ₂₁ ClN ₂	1,3-Di-t-butylimidazolium chloride, min. 98%	194	C ₁₂ H ₁₀ Se ₂	Diphenyldiselenide, 98%	404
C ₁₁ H ₂₁ NO ₃ S	(4S)-4-t-Butyl-1,2,3-oxathiazolidine-2,2-dioxide-3-carboxylic acid t-butyl ester, min. 97%	424	C ₁₂ H ₁₀ Zn	Diphenylzinc, 99%	451
	(4R)-4-t-Butyl-1,2,3-oxathiazolidine-2,2-dioxide-3-carboxylic acid t-butyl ester, min. 97%	424	C ₁₂ H ₁₁ P	Diphenylphosphine, 99% (10 wt% in hexanes)	303
C ₁₁ H ₂₃ CoNaO ₃ P ₃	Sodium(cyclopentadienyl)tris(dimethylphosphite)cobaltate(I), 98%	422	C ₁₂ H ₁₂ Cr	Bis(benzene)chromium, min. 97%	44
C ₁₁ H ₂₃ O ₃ P	(Rp)-Hydroxymethylphosphonic acid [(1R,2S,2R)-2-i-propyl-5-methylcyclohexanol]ester, 99%	315	C ₁₂ H ₁₂ Fe	Vinylferrocene, 99%	111
C ₁₁ H ₂₅ O ₃ PS	Di-t-butyl(3-sulfonatopropyl)phosphine, min. 98%	290	C ₁₂ H ₁₂ FeO	Acetylferrocene, 99.5%	94
C ₁₁ H ₂₅ P	Di-t-butyl(i-propyl)phosphine, min. 98%	290	C ₁₂ H ₁₂ FeO ₂	Ferrocenylacetic acid, min. 98%	105
C ₁₁ H ₂₅ NP	3-(Di-t-butylphosphino)propylamine, min. 97% (10 wt% in THF)	290	C ₁₂ H ₁₂ N ₂	4,4'-Dimethyl-2,2'-bipyridine, 99% DMBPY	197
C ₁₁ H ₂₆ N ₄	1,4,8,12-Tetraazacyclotetradecane, min. 98%	207	C ₁₂ H ₁₂ O ₂ Si	Diphenylsilanediol, min. 95%	407
C ₁₁ H ₂₆ O ₄ Si	2,2-Dimethyl-4,7,10,13-tetraoxa-2-silatetradecane, 99+% Electrolyte Solvent ANL-1S1M3	407	C ₁₂ H ₁₂ O ₃ W	Mesitylene tungsten tricarbonyl, 98%	443
C ₁₁ H ₂₇ B ₂ F ₈ NP	(3-Ammoniopropyl)di-t-butylphosphonium bis(tetrafluoroborate), min. 97%	250	C ₁₂ H ₁₂ Ru ₂ Cl ₄	Dichloro(benzene)ruthenium(II) dimer, 98%	382
C ₁₂ Co ₂ O ₁₂	Tetracobalt dodecacarbonyl, min. 98%	52	C ₁₂ H ₁₂ Si	Diphenylsilane, min. 97%	407
C ₁₂ F ₂₃ N	Perfluorotri-n-butylamine, min. 85%	65	C ₁₂ H ₁₂ Ti	Cyclopentadienyl(cycloheptatrienyl)titanium(II), 99%	439
C ₁₂ F ₃ O ₁₂	Iron dodecacarbonyl (Stabilized with 5-10% methanol)	107	C ₁₂ H ₁₃ NS ₂	2-Cyano-2-butylbenzodithiolate	424
C ₁₂ H ₄ Br ₄ N ₂	3,5,6,8-Tetrabromo-1,10-phenanthroline, 98%	208	C ₁₂ H ₁₃ N ₂ P	Bis(2-cyanoethyl)phenylphosphine, min. 97%	256
C ₁₂ H ₄ N ₄	7,7,8,8-Tetracyanoquinodimethane, 98% TCNQ	209	C ₁₂ H ₁₄ Cl ₂ SiZr	[Dimethylbis(cyclopentadienyl)silyl]zirconium dichloride, min. 98%	455
C ₁₂ H ₆ F ₅ N	2-(2,4-Difluorophenyl)-5-(trifluoromethyl)pyridine, 98% dF(CF ₃)ppy	196	C ₁₂ H ₁₄ Fe	Ethylferrocene, 98%	105
C ₁₂ H ₆ Br ₂	2,2-Dibromobiphenyl, 98+%	39	C ₁₂ H ₁₄ FeO	1,1'-Dimethylferrocene, min. 98%	102
			C ₁₂ H ₁₄ FeO	α-Hydroxyethylferrocene, 98%	106
			C ₁₂ H ₁₆ F ₉ N ₂ O ₅ S ₃	1,2-Dimethyl-3-propylmethylidiazolium tris(trifluoromethylsulfonyl)imide, 99% [DMPIme]	82
			C ₁₂ H ₁₆ MoN ₃ O ₃	Tricarbonyltris(propionitrile)molybdenum (O), min. 95%	138
			C ₁₂ H ₁₅ O ₂ Rh	Dicarbonyl(pentamethylcyclopentadienyl)rhodium(II), 99% (99.9%-Rh)	357
			C ₁₂ H ₁₆ Hf	Bis(cyclopentadienyl)dimethylhafnium, min. 97%	76
			C ₁₂ H ₁₆ N ₂ O ₂ S ₂	1,3-(N-Mercaptoethylcarboxamide)benzene, 99% BDET	426
			C ₁₂ H ₁₆ Zr	Bis(cyclopentadienyl)dimethylzirconium, min. 97%	454
			C ₁₂ H ₁₇ BO ₃	2-(4,4,5,5-Tetramethyl-1,3,2-dioxaborolan-2-yl)phenol, min. 97%	30
				3-(4,4,5,5-Tetramethyl-1,3,2-dioxaborolan-2-yl)phenol, min. 97%	30
				4-(4,4,5,5-Tetramethyl-1,3,2-dioxaborolan-2-yl)phenol, min. 97%	30
			C ₁₂ H ₁₇ N ₃	(S)-(-)-2-(α-(i-butyl)methanamine)-1H-benzimidazole, min. 98% (S)-i-Bu-BIMAH	190
				(R)-(+)-2-(α-(i-butyl)methanamine)-1H-benzimidazole, min. 98% (R)-i-Bu-BIMAH	190
				(S)-(-)-2-(α-(t-butyl)methanamine)-1H-benzimidazole, min. 95% (S)-t-Bu-BIMAH	189
			C ₁₂ H ₁₈ BF ₄ N ₂ Rh	Bis(acetonitrile)(1,5-cyclooctadiene)rhodium(I) tetrafluoroborate, min. 97%	349

Formula Index

Formula	Description	Page
C ₁₂ H ₁₈ BNO ₂	4-(4,4,5,5-Tetramethyl-1,3,2-dioxaborolan-2-yl)aniline, min. 97%	29
C ₁₂ H ₁₆ Cl ₂ Ru	Dichloro(2,6,10-dodecatriene-1,12-diyl)ruthenium(IV), 99%	392
C ₁₂ H ₁₆ CuO ₆	Copper(II) ethylacetoacetate, 99%	56
C ₁₂ H ₁₆ IrN ₂ BF ₄	Bis(acetonitrile)(1,5-cyclooctadiene)iridium(II) tetrafluoroborate, min. 97%	86
C ₁₂ H ₁₆ O ₂ Pd ₃	Palladium(II) acetate, min. 98% (99.9+%-Pd)	247
C ₁₂ H ₂₀	Tetramethyl(n-propyl)cyclopentadiene, min. 97%	40
C ₁₂ H ₂₀ N ₄	1,4-Bis(2-isocyanopropyl)piperazine (SnatchCat Metal Scavenger)	128
C ₁₂ H ₂₀ Sn	Tetraallytin, min. 95%	435
C ₁₂ H ₂₀ ClP	Dicyclohexylchlorophosphine, min. 98%	291
C ₁₂ H ₂₀ CuO ₄	Copper(II) gluconate, min. 98%	57
C ₁₂ H ₂₀ O ₂	2,2,6,6-Tetramethyl-3,5-octanedione, 98% (TMOD)	221
C ₁₂ H ₂₃ BF ₄ N ₃	1-Methyl-3-octylimidazolium tetrafluoroborate, 98% [OMIM][BF ₄]	83
C ₁₂ H ₂₃ P	Dicyclohexylphosphine, 98% (10 wt% in hexanes)	292
C ₁₂ H ₂₄ B ₂ O ₄	Dicyclohexylphosphine, 98%	292
C ₁₂ H ₂₄ B ₂ O ₄	Bis(hexyleneglycolato)diboron, 99%	24
C ₁₂ H ₂₄ Cl ₃ CrO ₃	Bis(pinacolato)diboron, 99%	24
C ₁₂ H ₂₄ Cl ₃ CrO ₃	Chromium(III) chloride tetrahydrofuran adduct, 98%	45
C ₁₂ H ₂₄ Cl ₃ MoO ₃	Trichlorotris(tetrahydrofuran)molybdenum(III), min. 95%	138
C ₁₂ H ₂₄ Cl ₃ O ₃ Ti	Trichlorotris(tetrahydrofuran)titanium(III), min. 97%	443
C ₁₂ H ₂₄ Cl ₃ O ₃ V	Vanadium(III) chloride tetrahydrofuran adduct	445
C ₁₂ H ₂₄ Cu ₄ I ₄ N ₄	Bis(1,4-diazabicyclo [2.2.2]octane)tetra(copper(I) iodide) (Cu) ₄ (DABCO) ₂	54
C ₁₂ H ₂₄ O ₄ Sn	Di-n-butyltin diacetate, min. 96%	434
C ₁₂ H ₂₄ O ₆	18-Crown-6, 99%	216
C ₁₂ H ₂₄ LiO ₄ S	Lithium dodecyl sulfate, min. 98%	168
C ₁₂ H ₂₄ NaO ₄ S	Sodium dodecylsulfate, 98+%	168
C ₁₂ H ₂₄ NaO ₄ S	Sodium dodecylsulfate, min. 99%	168
C ₁₂ H ₂₅ P	Di-t-butyl(2-butenyl)phosphine (40% in xylene), 98% m-CroPhos®	286
C ₁₂ H ₂₆ N ₂ Sn	N,N'-Di-t-butyl-2,3-diamidobutanetin(II), 98%	434
C ₁₂ H ₂₇ Al	Tri-i-butylaluminum, min. 95%	4
C ₁₂ H ₂₇ AlO ₃	Aluminum s-butoxide, 98%	1
C ₁₂ H ₂₇ AuClP	Chlorotri-t-butylphosphinegold(I), 99%	74
C ₁₂ H ₂₇ BO ₃	Tri-n-butylborate, 98%	30
C ₁₂ H ₂₇ ClSn	Tri-n-butyltin chloride, 96%	437
C ₁₂ H ₂₇ O ₃ P	Tri-n-butylphosphite, min. 94%	326
C ₁₂ H ₂₇ O ₃ Sb	n-Dodecylphosphonic acid, min. 97% DDPA	312
C ₁₂ H ₂₇ O ₃ Sb	Antimony(III) n-butoxide, 99%	8
C ₁₂ H ₂₇ P	Tri-i-butylphosphine, min. 93%	325
C ₁₂ H ₂₇ P	Tri-n-butylphosphine, 99%	325
C ₁₂ H ₂₇ P	Tri-n-butylphosphine, min. 93%	325
C ₁₂ H ₂₇ P	Tri-n-butylphosphine, 99% (10 wt% in hexanes)	325
C ₁₂ H ₂₇ P	Tri-t-butylphosphine, 99%	326
C ₁₂ H ₂₇ P	Tri-t-butylphosphine, 99% (10 wt% in hexanes) (Sure/Seal™ bottle)	326
C ₁₂ H ₂₇ P	Tri-t-butylphosphine, min. 98%	325
C ₁₂ H ₂₇ P	Tri-t-butylphosphine, min. 98% (50wt% in toluene)	325
C ₁₂ H ₂₇ P	Di-t-butyl(n-butyl)phosphine, min. 97%	286
C ₁₂ H ₂₈ AlLiO ₃	Lithium tri-t-butoxyaluminumhydride, ~1.0M in THF	118
C ₁₂ H ₂₈ BF ₄ P	Tri-n-butylphosphonium tetrafluoroborate, 99%	326
C ₁₂ H ₂₈ BF ₄ P	Tri-t-butylphosphonium tetrafluoroborate, 99%	326
C ₁₂ H ₂₈ BK	Potassium tri-sec-butylborohydride, 1.0M in THF, in Sure/Seal™ bottle	345
C ₁₂ H ₂₈ ClN ₂ P	Bis(di-i-propylamino)chlorophosphine, min. 97%	272
C ₁₂ H ₂₈ Cu ₄ I ₄ N ₄	Bis(N,N'-dimethylpiperazine)tetra(copper(I) iodide), 98% MOF	55

Formula	Description	Page
C ₁₂ H ₂₈ HfO ₄	Hafnium(IV) i-propoxide monoisopropylate, 99%	77
C ₁₂ H ₂₈ MgN ₂	Magnesium bis(di-i-propylamide) 0.7M (18wt% ±2wt%) in tetrahydrofuran	122
C ₁₂ H ₂₈ NO ₄ Ru	Tetrapropylammonium perruthenate, min. 97% TPAP	8
C ₁₂ H ₂₈ N ₂	N,N'-Di-t-butyl-2,3-diaminobutane, 98%	194
C ₁₂ H ₂₈ N ₂ O ₂ Pb	Bis(1-dimethylamino-2-methyl-2-propanolate)lead(II), 98% Pb(DMAMP) ₂	114
C ₁₂ H ₂₈ O ₄ Si	Tri-t-butoxysilanol (99.999%-Si) PURATREM	411
C ₁₂ H ₂₈ O ₄ Si	Tri-t-butoxysilanol (99.999%-Si) PURATREM 14-7015 contained in 50 ml Swagelok® cylinder (96-1077) for CVD/ALD	411
C ₁₂ H ₂₈ O ₄ Si	Tri-t-butoxysilanol (99.9+%-Si)	411
C ₁₂ H ₂₈ O ₄ Ti	Titanium(IV) i-propoxide, min. 98%	442
C ₁₂ H ₂₈ O ₄ Ti	Titanium(IV) i-propoxide, min. 98%, 93-2216, contained in 50 ml Swagelok® cylinder (96-1070) for CVD/ALD	442
C ₁₂ H ₂₈ O ₄ Zr	Zirconium(IV) i-propoxide (isopropanol adduct) (99.9%-Zr)	458
C ₁₂ H ₂₈ O ₄ Zr	Zirconium(IV) n-propoxide (23-28% free alcohol)	458
C ₁₂ H ₂₈ Sn	Tetra-i-propyltin, min. 98%	436
C ₁₂ H ₂₈ Sn	Tetra-n-propyltin, min. 97%	436
C ₁₂ H ₃₀ Cl ₂ P ₂ Pt	Tri-n-butyltin hydride, min. 95%	437
C ₁₂ H ₃₀ Cl ₂ P ₂ Pt	cis-Dichlorobis(triethylphosphine) platinum(II), 99%	337
C ₁₂ H ₃₀ MoN ₄	Bis(t-butylimido)bis(dimethylamino)molybdenum(VI), 98%	136
C ₁₂ H ₃₀ N ₄ W	Bis(t-butylimido)bis(dimethylamino)tungsten(VI), min. 97% BTBMW	443
C ₁₂ H ₃₂ HfN ₄	Tetrakis(ethylmethylamino)hafnium, 99% (99.99+%-Hf, <0.15% Zr) TEMA PURATREM	78
C ₁₂ H ₃₂ N ₄ V	Tetrakis(ethylmethylamino)hafnium, 99% (99.99+%-Hf, <0.15% Zr) TEMA PURATREM, 72-7720, contained in 50 ml Swagelok® cylinder (96-1070) for CVD/ALD	78
C ₁₂ H ₃₂ N ₄ V	Tetrakis(ethylmethylamino)vanadium(IV), 98% TEMA V	445
C ₁₂ H ₃₂ N ₄ Zr	Tetrakis(ethylmethylamino)zirconium(IV), 99% TEMA Z	457
C ₁₂ H ₃₂ N ₄ Zr	Tetrakis(ethylmethylamino)zirconium(IV) 99% TEMA Z, 40-1710, contained in 50 ml Swagelok® cylinder (96-1070) for CVD/ALD	457
C ₁₂ H ₃₆ Al ₂ N ₆	Hexakis(dimethylamino)dialuminum 98% (99.9%-Al) TDMAA	4
C ₁₂ H ₃₆ Ga ₂ N ₆	Bis(μ-dimethylamino)tetrakis(dimethylamino)digallium, 98%	67
C ₁₂ H ₃₆ N ₆ Si ₂	Hexakis(ethylamino)disilane (99.995%-Si) PURATREM	408
C ₁₂ H ₃₆ Si ₅	Tetrakis(trimethylsilyl)silane, 98% TMSS	410
C ₁₂ H ₄ O ₁₂	Iridium carbonyl, min. 98%	92
C ₁₂ N ₂₈ N ₂ Sn	N,N'-Di-t-butyl-2,3-diamidobutanetin(II), 98%, 50-1150, contained in 50 ml Swagelok® cylinder (96-1070) for CVD/ALD	434
C ₁₂ O ₁₂ Os ₃	Osmium carbonyl, 99%	213
C ₁₂ O ₁₂ Rh ₄	Tettrahodium dodecacarbonyl, min. 98%	361
C ₁₂ O ₁₂ Ru ₃	Ruthenium carbonyl, 99%	398
C ₁₃ H ₈ ClN ₂ O ₃ Re	Chlorotricarbonyl(2,2'-bipyridine)rhenium(I), 99%	346
C ₁₃ H ₈ CuF ₃ N ₂	Trifluoromethyl(1,10-phenanthroline)copper(I), 95% Trifluoromethylator®	59
C ₁₃ H ₁₃ F ₆ IrO ₂	1,5-Cyclooctadiene(hexafluoroacetylacetonato)iridium(II), 98%	89
C ₁₃ H ₁₃ N	2-(N-Methylamino)-1,1'-biphenyl, min. 95%	202
C ₁₃ H ₁₃ NO ₂ S ₂	4-Cyano-4-(thiobenzoylthio)pentanoic acid, min. 97%	425
C ₁₃ H ₁₃ P	Methyldiphenylphosphine, 99%	315
C ₁₃ H ₁₄ N ₃	1,3-Di-(4-pyridyl)propane, 98%	199
C ₁₃ H ₁₅ NS ₂	2-Cyano-2-pentylbenzodithiolate	425
C ₁₃ H ₁₅ NS ₂	2-Cyano-3-methyl-2-butylbenzodithiolate	425
C ₁₃ H ₁₅ O ₃ Re	Pentamethylcyclopentadienylium tricarbonyl, min. 98%	347
C ₁₃ H ₁₆	1-T-butyl-1H-indene, min. 95%	38
C ₁₃ H ₁₆ F ₆ N ₂ O ₂ S ₂	N-Butyl-3-methylpyridinium bis(trifluoromethylsulfonyl)imide, 99% [BMPIm]	82
C ₁₃ H ₁₇ BO ₄	3-(4,4,5,5-Tetramethyl-1,3,2-dioxaborolan-2-yl)benzoic acid, min. 97%	29

Formula Index

Formula	Description	Page	Formula	Description	Page
C ₁₃ H ₁₇ FeN	4-(4,4,5,5-Tetramethyl-1,3,2-dioxaborolan-2-yl)benzoic acid, min. 97% N,N-Dimethylaminomethylferrocene, min. 95%	29	C ₁₄ H ₁₄ F ₁₃ NO ₂	(4S,5R)-(-)-4-i-Propyl-5-(3,3,4,4,5,5,6,6,7,7,8,8,8-tridecafluorooctyl)-2-oxazolidinone, 99% (4R,5S)-(+)-4-i-Propyl-5-(3,3,4,4,5,5,6,6,7,7,8,8,8-tridecafluorooctyl)-2-oxazolidinone, 99%	206
C ₁₃ H ₁₇ Ir	1-Ethylcyclopentadienyl-1,3-cyclohexadieniridium(I), 99% (99.9%-Ir)	102	C ₁₄ H ₁₄ N ₄ O ₄	(1R,2R)-(+)-1,2-Bis(4-nitrophenyl)ethylene-diamine dihydrochloride, min. 98%	206
C ₁₃ H ₁₇ NO ₃ S	(4R)-4-Phenyl-1,2,3-oxathiazolidine-2,2-dioxide-3-carboxylic acid t-butyl ester, min. 97%	91	C ₁₄ H ₁₄ O ₂ S ₂	1,2-Bis(phenylsulfanyl)ethane, 99%	187
C ₁₃ H ₁₆ ClNO ₂	(4S,5S)-2-Allyl-2-chloro-3,4-dimethyl-5-phenyl-1-oxa-3-aza-2-silacyclopentane, min. 98% (-2:1 mixture of diastereomers)	427	C ₁₄ H ₁₄ Pd	Cyclopentadienyl[(1,2,3-n)-1-phenyl-2-propenyl]palladium(II), 98%	424
C ₁₃ H ₁₆ N ₂ O ₂ S	1-Ethyl-3-methylimidazolium tosylate, 98% [EMIM] [TOS]	405	C ₁₄ H ₁₅ NO	(1R,2S)-2-Amino-1,2-diphenylethanol, min. 98%	178
C ₁₃ H ₁₉ AgF ₆ O ₂ Si	Vinyltriethylsilane(hexafluoroacetylacetonato)silver(I) (99.9%-Ag)	82	C ₁₄ H ₁₅ P	(1S,2R)-2-Amino-1,2-diphenylethanol, min. 98%	178
C ₁₃ H ₁₈ BO ₄	2-Methoxy-4-(4,4,5,5-tetramethyl-1,3,2-dioxaborolan-2-yl)phenol, min. 97%	415	C ₁₄ H ₁₆ P	Di-p-tolylphosphine, 99% (10 wt% in hexanes)	311
C ₁₃ H ₁₈ IrO ₂	1,5-Cyclooctadiene(acetylacetonato)iridium(I), 99% (99.9%-Ir)	27	C ₁₄ H ₁₆ Rh	Di-p-tolylphosphine, 99%	311
C ₁₃ H ₁₉ NO	(1R,2R)-2-Benzylamino-1-cyclohexanol, min. 98%	88	C ₁₄ H ₁₆ BF ₄ Rh	Di-o-tolylphosphine, min. 97%	311
C ₁₃ H ₁₉ O ₂ Rh	(1S,2S)-2-Benzylamino-1-cyclohexanol, min. 98%	179	C ₁₄ H ₁₆ Cl ₂ Rh ₂	Bis(norbornadiene)rhodium(I) tetrafluoroborate, min. 96%	355
C ₁₃ H ₂₃ ClN ₂ Ni	Chloro(2-methylphenyl)(N,N,N',N'-tetramethyl-1,2-ethylenediamine)nickel(II), 99% (contains about 5% o-chlorotoluene) NiCl(o-tolyl)(TMEDA)	179	C ₁₄ H ₁₆ Cl ₂ Rh ₂	Chloronorbornadiene rhodium(I) dimer, 99%	357
C ₁₃ H ₂₄ O ₃ Ti	Pentamethylcyclopentadienyltitanium trimethoxide, min. 97%	349	C ₁₄ H ₁₆ FeO	Butyroferrocene, 99%	100
C ₁₃ H ₂₄ Pt	(Trimethyl)pentamethylcyclopentadienylplatinum(IV), 99%	440	C ₁₄ H ₁₆ IP	Dimethyldiphenylphosphonium iodide, 98%	299
C ₁₃ H ₂₄ Si	Trimethylsilylpentamethylcyclopentadiene	339	C ₁₄ H ₁₆ NP	2-(Diphenylphosphino)ethylamine, min. 95%	314
C ₁₃ H ₂₄ Ti	(Trimethyl)pentamethylcyclopentadienyltitanium(IV), min. 97%	412	C ₁₄ H ₁₆ N ₂	(1R,2R)-(+)-1,2-Diphenylethylenediamine, min. 97% (R,R)-DPEN	198
C ₁₃ H ₂₅ BF ₄ N ₂	(2R,5R)-1-[[[(2R,5R)-2,5-Dimethylpyrrolidin-1-yl]methylene]-2,5-dimethylpyrrolidinium tetrafluoroborate, min. 97%	443	C ₁₄ H ₁₆ N ₂ O ₂	(1S,2S)-(-)-1,2-Diphenylethylenediamine, min. 97% (S,S)-DPEN	198
C ₁₃ H ₂₇ O ₆ Ta	Tantalum(V) (tetraethoxy)(acetylacetonate) (99.99%-Ta) PURATREM	198	C ₁₄ H ₁₆ N ₂ O ₂	(1R,2R)-(-)-1,2-Bis(4-hydroxyphenyl)ethylenediamine dihydrochloride, min. 98%	185
C ₁₃ H ₂₇ P	Di-t-butyl(3-methyl-2-butenyl)phosphine (40% in xylene), 98% Crophos®	430	C ₁₄ H ₁₆ N ₂ O ₂	(1R,2R)-1,2-Bis(2-hydroxyphenyl)ethane-1,2-diamine, min. 97%	185
C ₁₃ H ₂₆ F ₃ O ₃ PS	Tri-t-butylphosphonium trifluoromethanesulfonate, 99% Stabiphos T	287	C ₁₄ H ₁₆ O ₂ Si	(1S,2S)-1,2-Bis(2-hydroxyphenyl)ethane-1,2-diamine, min. 97%	185
C ₁₃ H ₂₆ BF ₄ N ₂	Di-i-propylamineoxyethylene(di-i-propyl)aminium tetrafluoroborate, min. 97%	326	C ₁₄ H ₁₆ P ₂	Diphenyldimethoxysilane, min. 97%	407
C ₁₃ H ₂₉ P	Di-t-butylneopentylphosphine, min. 95% (DTBNpP)	198	C ₁₄ H ₁₆ P ₂	1,2-Bis(phenylphosphino)ethane, min. 90%	279
C ₁₃ H ₃₀ BF ₄ P	Di-t-butylneopentylphosphonium tetrafluoroborate, min. 95%	287	C ₁₄ H ₁₆ Sn	1,2-Bis(phenylphosphino)ethane, min. 95% (10wt% in hexanes)	279
C ₁₃ H ₃₃ N<-4Ta	(t-Butylimido)tris(ethylmethylamino)tantalum(V) (99.99%-Ta) PURATREM	287	C ₁₄ H ₁₆ NP	Dimethyldiphenyltin	435
C ₁₄ HF ₂₇ O ₂	Perfluorotetradecanoic acid, min. 97%	429	C ₁₄ H ₁₇ BF ₄ NP	2-(Diphenylphosphino)ethan ammonium tetrafluoroborate, min. 97%	304
C ₁₄ H ₆ F ₃ N ₂ O ₆	Trifluoromethylsulfonatotricarbonyl(2,2'-bipyridine)rhenium(I), 99%	168	C ₁₄ H ₁₇ NO ₃ S	(4S,5R)-3,3a,8,8a-Tetrahydroindeno[1,2-d]-1,2,3-oxathiazole-2,2-dioxide-3-carboxylic acid t-butyl ester, min. 97%	427
C ₁₄ H ₈ F ₆ O ₆ S ₂	2,2'-Bis(trifluoromethanesulfonyloxy)-1,1'-biphenyl, 99% (1,1'-Biphenol bistriflate)	348	C ₁₄ H ₁₇ NO ₃ S	(4R,5S)-3,3a,8,8a-Tetrahydroindeno[1,2-d]-1,2,3-oxathiazole-2,2-dioxide-3-carboxylic acid t-butyl ester, min. 97%	427
C ₁₄ H ₁₀	Diphenylacetylene, 99%	215	C ₁₄ H ₁₇ NS ₂	2-Cyano-2-hexylbenzothiolate	424
C ₁₄ H ₁₀ Cl ₂ N ₂ Pd	Dichlorobis(benzonitrile)palladium(II), 99%	39	C ₁₄ H ₁₆ BF ₄ O ₂ Rh	1,5-Cyclooctadiene(hydroquinone)rhodium(I) tetrafluoroborate	357
C ₁₄ H ₁₀ Cl ₂ N ₂ Pt	Dichlorobis(benzonitrile)platinum(II), 99%	39	C ₁₄ H ₁₆ Cl ₂ Hf	Bis(ethylcyclopentadienyl)hafnium dichloride, min. 98%	76
C ₁₄ H ₁₀ Fe ₂ O ₄	Cyclopentadienyliron dicarbonyl dimer, 99%	236	C ₁₄ H ₁₆ Cl ₂ Ti	Bis(ethylcyclopentadienyl)titanium(IV) dichloride, min. 98%	439
C ₁₄ H ₁₀ N ₂ O ₂	4,7-Dimethoxy-1,10-phenanthroline, 98%	337	C ₁₄ H ₁₆ Cl ₂ Zr	Bis(ethylcyclopentadienyl)zirconium dichloride, min. 97%	455
C ₁₄ H ₁₀ O ₄	[1,1'-Biphenyl]-4,4'-dicarboxylic acid, min. 98%	100	C ₁₄ H ₁₆ Cr	Bis(ethylcyclopentadienyl)chromium, min. 98%	44
C ₁₄ H ₁₀ O ₄ Pd	Palladium(II) benzoate, 99%	197	C ₁₄ H ₁₆ Fe	Bis(ethylcyclopentadienyl)iron, min. 98%	98
C ₁₄ H ₁₀ O ₄ Ru ₂	Dicarbonylcyclopentadienylruthenium dimer, 99%	215	C ₁₄ H ₁₆ Fe	t-Butylferrocene, min. 98%	100
C ₁₄ H ₁₆ P	Vinylidiphenylphosphine, min. 97%	248	C ₁₄ H ₁₆ Mg	n-Butylferrocene, 99%	100
C ₁₄ H ₁₄ CIP	Di-o-tolylchlorophosphine, min. 98%	381	C ₁₄ H ₁₆ Mg	Bis(ethylcyclopentadienyl)magnesium, min. 98%	120
C ₁₄ H ₁₄ Cl ₂ N ₂	meso-1,2-Bis(4-chlorophenyl)ethylenediamine, min. 98%	333	C ₁₄ H ₁₆ Mg	Bis(ethylcyclopentadienyl)magnesium, min. 98%, 12-0510, contained in 50 ml Swagelok® cylinder (96-1070) for CVD/ALD	121
		311	C ₁₄ H ₁₆ Mn	Bis(ethylcyclopentadienyl)magnesium, min. 98%, 12-0510, contained in high-temp 50 ml Swagelok® cylinder (96-1071) for CVD/ALD	121
		181	C ₁₄ H ₁₆ Mn	Bis(ethylcyclopentadienyl)manganese, min. 98%	125
			C ₁₄ H ₁₆ Ni	Bis(ethylcyclopentadienyl)manganese, min. 98%, 25-0210, contained in 50 ml Swagelok® cylinder (96-1070) for CVD/ALD	125
			C ₁₄ H ₁₆ Ni	Bis(ethylcyclopentadienyl)nickel, min. 98%	172
			C ₁₄ H ₁₆ Ru	Bis(ethylcyclopentadienyl)ruthenium(II), 98% (99.9%-Ru)	365

Formula Index

Formula	Description	Page	Formula	Description	Page
	Bis(ethylcyclopentadienyl)ruthenium(II), 98% (99.9%-Ru), 44-0040, contained in 50 ml Swagelok® cylinder (96-1070) for CVD/ALD.	365	C ₁₄ H ₃₂ N ₄	1,4,8,11-Tetramethyl-1,4,8, 11-tetraazacyclo-tetradecane, 98%	209
	Bis(ethylcyclopentadienyl)ruthenium(II), 98% (99.9%-Ru), 44-0040, contained in high-temp 50 ml Swagelok® cylinder (96-1071) for CVD/ALD.	365	C ₁₄ H ₃₂ P ₂	1,2-Bis(di- <i>i</i> -propylphosphino)ethane, 98%	273
C ₁₄ H ₁₉ BO ₄	2-(4,4,5,5-Tetramethyl-1,3,2-dioxaborolan-2-yl)phenyl acetate, min. 97%	30	C ₁₄ H ₃₃ O ₄ PS	Tributyl(methyl)phosphonium methylsulfate, min. 95%	83
	4-(4,4,5,5-Tetramethyl-1,3,2-dioxaborolan-2-yl)phenyl acetate, min. 97%	30	C ₁₅ H ₃ AlF ₁₈ O ₆	Aluminum hexafluoroacetylacetonate, min. 98%	2
C ₁₄ H ₁₉ FeN	α-(N,N-Dimethylamino)ethylferrocene, 98%..	102	C ₁₅ H ₃ CrF ₁₈ O ₆	Chromium(III) hexafluoroacetylacetonate, min. 98%	45
C ₁₄ H ₁₉ Ir	(Methylcyclopentadienyl) (1,5-cyclooctadiene)iridium(I), 99% (99.9%-Ir)	92	C ₁₅ H ₃ ErF ₁₈ O ₆	Erbium(III) hexafluoroacetylacetonate hydrate (99.9%-Er) (REO)	61
C ₁₄ H ₁₉ NO ₃	[(1R,2R)-2-Hydroxycyclohexyl]carbamic Acid Phenylmethyl Ester, min. 98%	201	C ₁₅ H ₃ F ₁₈ NdO ₆	Neodymium(III) hexafluoroacetylacetonate dihydrate (99.9%-Nd) (REO)	170
	[(1S,2S)-2-Hydroxycyclohexyl]carbamic Acid Phenylmethyl Ester, min. 98%	201	C ₁₅ H ₃ F ₁₈ O ₆ Pr	Praseodymium(III) hexafluoroacetylacetonate (99.9%-Pr) (REO)	345
C ₁₄ H ₁₉ NO ₅ S	(4S,5R)-4-Methyl-5-phenyl-1,2,3-oxathiazolidine-2,2-dioxide-3-carboxylic acid <i>t</i> -butyl ester, min. 97%	426	C ₁₅ H ₃ F ₁₈ O ₆ Y	Yttrium(III) hexafluoroacetylacetonate, hydrate (99.9%-Y) (REO)	449
	(4R,5S)-4-Methyl-5-phenyl-1,2,3-oxathiazolidine-2,2-dioxide-3-carboxylic acid <i>t</i> -butyl ester, min. 97%	426	C ₁₅ H ₃ F ₁₈ O ₆ Yb	Ytterbium(III) hexafluoroacetylacetonate dihydrate (99.9%-Yb) (REO)	447
C ₁₄ H ₂₀ BNO ₃	4-(4,4,5,5-Tetramethyl-1,3,2-dioxaborolan-2-yl)acetanilide, min. 97%	29	C ₁₅ H ₁₁ Cl ₃ N ₂	1,3-Bis(4-chlorophenyl)imidazolium chloride, min. 97%	181
C ₁₄ H ₂₀ FeIN	Ferrocenylmethyltrimethylammonium iodide, 99%	106	C ₁₅ H ₁₁ N ₃	2,2':6',2''-Terpyridine, min. 98% TERPY	207
	1-Ethyl-2,3-dimethylimidazolium tosylate, 98% [EDI[MIM] [TOS]	82	C ₁₅ H ₁₂ CeF ₉ O ₆	Cerium(III) trifluoroacetylacetonate hydrate ..	42
C ₁₄ H ₂₀ O ₅	Benzo-15-crown-5, 97%	214	C ₁₅ H ₁₂ F ₉ O ₆	Iron(III) trifluoroacetylacetonate, 99%	109
C ₁₄ H ₂₁ BO ₃	2,6-Dimethyl-4-(4,4,5,5-tetramethyl-1,3,2-dioxaborolan-2-yl)phenol, min. 97%	27	C ₁₅ H ₁₂ F ₉ NdO ₆	Indium(III) trifluoroacetylacetonate, 99%	80
C ₁₄ H ₂₁ I ₂ O ₂	1,2-Diiodo-4,5-di- <i>n</i> -butoxybenzene	218	C ₁₅ H ₁₂ F ₉ NdO ₆	Neodymium(III) trifluoroacetylacetonate (99.9%-Nd)	170
C ₁₄ H ₂₂ N ₂ O ₈	trans-1,2-Cyclohexanediaminetetraacetic acid monohydrate, min. 98% CyDTA	193	C ₁₅ H ₁₂ F ₉ O ₆ Sm	Samarium(III) trifluoroacetylacetonate (99.9%-Sm) (REO)	402
	trans-1,2-Cyclohexanediaminetetraacetic acid monohydrate, 99% CyDTA	193	C ₁₅ H ₁₂ N ₃ P	Tris(2-pyridyl)phosphine, min. 97%	332
C ₁₄ H ₂₂ Ru	Bis(2,4-dimethylpentadienyl)ruthenium(II), 99%	365	C ₁₅ H ₁₄ S ₂	2-Phenylethylbenzodithiolate	427
C ₁₄ H ₂₂ Cr ₃ O ₁₆	Chromium(III) acetate, basic	45	C ₁₅ H ₁₄ S ₃	S,S-Dibenzyltrithiocarbonate, min. 97%	425
C ₁₄ H ₂₄ N ₃ O ₁₀	Diethylenetriaminepentaacetic acid, 97% DTPA	195	C ₁₅ H ₁₅ Ce	Tris(cyclopentadienyl)cerium(III) (99.9%-Ce) (REO)	42
	Diethylenetriaminepentaacetic acid, 98.5% DTPA (USP)	195	C ₁₅ H ₁₅ Er	Tris(cyclopentadienyl)erbium(III) (99.9%-Er) (REO)	62
	Diethylenetriaminepentaacetic acid, 99% DTPA	195	C ₁₅ H ₁₅ Gd	Tris(cyclopentadienyl)gadolinium(III) (99.9%-Gd) (REO)	67
C ₁₄ H ₂₃ P	Di-2-norbornylphosphine, min. 98% (mixture of endo and exo isomers)	301	C ₁₅ H ₁₅ La	Tris(cyclopentadienyl)lanthanum (99.9%-La) (REO)	113
	Di-2-norbornylphosphine, min. 98% (mixture of endo and exo isomers) (10 wt% in hexanes)	301	C ₁₅ H ₁₅ Nd	Tris(cyclopentadienyl)neodymium, 99%	170
	Di- <i>t</i> -butylphenylphosphine, min. 98%	288	C ₁₅ H ₁₅ Pr	Tris(cyclopentadienyl)praseodymium (99.9%-Pr) (REO)	346
C ₁₄ H ₂₄ BF ₄ P	Di- <i>t</i> -butylphenylphosphonium tetrafluoroborate, 97%	288	C ₁₅ H ₁₅ Sm	Tris(cyclopentadienyl)samarium (99.9%-Sm) (REO)	403
C ₁₄ H ₂₄ NP	2-(Di- <i>t</i> -butylphosphinomethyl)pyridine, 99%..	289	C ₁₅ H ₁₅ Tm	Tris(cyclopentadienyl)thulium (99.9%-Tm) (REO)	433
C ₁₄ H ₂₄ N ₂ O ₁₀	Ethylene glycol-bis(2-aminoeth-yl)-N,N,N',N'-tetraacetic acid, 99% EGTA	199	C ₁₅ H ₁₅ Y	Tris(cyclopentadienyl)yttrium (99.9%-Y) (REO)	448
C ₁₄ H ₂₇ AuF ₆ NO ₄	Tri- <i>t</i> -butylphosphine[bis(trifluoromethyl)sulfonylimido]gold(I), 98%	76	C ₁₅ H ₁₅ Yb	Tris(cyclopentadienyl)ytterbium (99.9%-Yb) (REO)	447
C ₁₄ H ₂₇ O ₁₈ Ru ₃	Hexakis[μ-(acetato-O:O')]triqua-μ ₃ -oxo-ruthenium(III), min. 95% (Ruthenium(III) acetate)	397	C ₁₅ H ₁₈ NP	3-(Diphenylphosphino)propylamine, min. 97%	308
C ₁₄ H ₂₈ N ₂ O ₆ S	1-Butyl-2,3-dimethylimidazolium diethyleneglycolmonomethylether sulfate, 98% [BDI[MIM] [MDEGSO ₁]	81	C ₁₅ H ₁₈ P ₂	1,3-Bis(phenylphosphino)propane, 90-95%	279
	(+)-1,2-Bis((2R,5R)-2,5-dimethylphospholano)ethane, 98+% (R,R)-Me-BPE	265	C ₁₅ H ₁₈ BF ₄ NP	3-(Diphenylphosphino)propylammonium tetrafluoroborate	309
	(-)-1,2-Bis((2S,5S)-2,5-dimethylphospholano)ethane, 98+% (S,S)-Me-BPE	265	C ₁₅ H ₁₉ F ₃ PrU	Cyclopentadienyl(<i>p</i> -cymene)ruthenium(II) hexafluorophosphate, min. 98%	379
C ₁₄ H ₂₉ P	Cyclohexyldi- <i>t</i> -butylphosphine, 97%	283	C ₁₅ H ₂₁ AlO ₆	Aluminum acetylacetonate, 99%	1
C ₁₄ H ₂₉ P	Cyclohexyldi- <i>t</i> -butylphosphine, 98% (10wt% in hexanes)	283	C ₁₅ H ₂₁ BO ₄	Ethyl-4-(4,4,5,5-tetramethyl-1,3,2-dioxaborolan-2-yl)benzoate, min. 97%	27
C ₁₄ H ₃₀ O ₂ Sn	Tri- <i>n</i> -butyltin acetate, 98%	437		Ethyl-2-(4,4,5,5-tetramethyl-1,3,2-dioxaborolan-2-yl)benzoate, min. 97%	27
C ₁₄ H ₃₁ O ₃ P	<i>n</i> -Tetradecylphosphonic acid, min. 97%	321	C ₁₅ H ₂₁ ErO ₆	Ethyl-3-(4,4,5,5-tetramethyl-1,3,2-dioxaborolan-2-yl)benzoate, min. 97%	27
C ₁₄ H ₃₂ BF ₄ P	Di- <i>t</i> -butyl(<i>n</i> -hexyl)phosphonium tetrafluoroborate, 98%	287	C ₁₅ H ₂₁ CeO ₆	Cerium(III) acetylacetonate hydrate (99.9%-Ce) (REO)	40
			C ₁₅ H ₂₁ CoO ₆	Cobalt(III) acetylacetonate, 98+%	48
			C ₁₅ H ₂₁ CrO ₆	Chromium(III) acetylacetonate, 97.5%	45
			C ₁₅ H ₂₁ DyO ₆	Dysprosium(III) acetylacetonate hydrate (99.9%-Dy) (REO)	60
			C ₁₅ H ₂₁ ErO ₆	Erbium(III) acetylacetonate hydrate (99.9%-Er) (REO)	61
			C ₁₅ H ₂₁ FeO ₆	Iron(III) acetylacetonate, 99%	106
			C ₁₅ H ₂₁ GaO ₆	Gallium(III) acetylacetonate (99.99%-Ga) PURATREM	67

Formula Index

Formula	Description	Page	Formula	Description	Page
C ₁₅ H ₂₁ GdO ₆	Gadolinium(III) acetylacetonate hydrate (99.99%-Gd) (REO).....	66	C ₁₆ H ₁₆ CINOSi	(4S,5S)-2-Chloro-3,4-dimethyl-2,5-diphenyl-1-oxa-3-aza-2-silacyclopentane, min. 98% (-2:1 mixture of diastereomers).....	406
C ₁₅ H ₂₁ InO ₆	Indium(III) acetylacetonate, 98%.....	79	C ₁₆ H ₁₆ F ₁₂ FeN ₂ O ₄	Bis(1,1,1,5,5,5-hexafluoroacetylacetonato)(N,N,N',N'-tetramethylethylenediamine) iron(II), min. 98%.....	99
C ₁₅ H ₂₁ IrO ₆	Iridium(III) acetylacetonate, 98%.....	92	C ₁₆ H ₁₆ O ₂	3,3',5,5'-Tetramethyl-2,2'-biphenol, 99%.....	220
C ₁₅ H ₂₁ LaO ₆	Lanthanum(III) acetylacetonate hydrate (99.9%-La) (REO).....	112	C ₁₆ H ₁₆ BrN ₂	2,6-Bis(dimethylamino)-2'-bromo-1,1'-biphenyl, min. 98%.....	182
C ₁₅ H ₂₁ MnO ₆	Manganese(III) acetylacetonate, min. 90%... ..	125	C ₁₆ H ₁₆ FeNO	(S)-(-)-[4,5-Dihydro-4-(1-methylethyl)-2-oxazolyl]ferrocene, min. 98%.....	102
C ₁₅ H ₂₁ O ₂ P	2-[2-(2R,5R)-2,5-Dimethyl-1-phospholano]phenyl]1,3-dioxolane, min. 97%.....	299	C ₁₆ H ₁₆ P	Bis(3,5-dimethylphenyl)phosphine, 98%.....	264
C ₁₅ H ₂₁ O ₆ Pr	Praseodymium(III) acetylacetonate hydrate (99.9%-Pr) (REO).....	345	C ₁₆ H ₂₀ Cr	Bis(ethylbenzene)chromium [mixture of (C ₂ H ₅) ₂ C ₂ H ₄ n _x where x = 0-4].....	44
C ₁₅ H ₂₁ O ₆ Rh	Rhodium(III) acetylacetonate, 97+% (99.9%-Rh).....	358	C ₁₆ H ₂₀ Mo	Bis(ethylbenzene)molybdenum [mixture of (C ₂ H ₅) ₂ C ₂ H ₄ n _x where x = 0-4].....	136
C ₁₅ H ₂₁ O ₆ Ru	Ruthenium(III) acetylacetonate, 99%.....	398	C ₁₆ H ₂₀ N ₂ O ₂	N,N'-Bis(2-hydroxybenzyl)ethylenediamine, min. 98% H ₄ SALEN.....	185
C ₁₅ H ₂₁ O ₆ Sm	Samarium(III) acetylacetonate hydrate (99.9%-Sm) (REO).....	402	C ₁₆ H ₂₁ O ₃ P	1,3,5,7-Tetramethyl-8-phenyl-2,4,6-tri-oxa-8-phosphaadamantane, 99% MeCgPPh.....	324
C ₁₅ H ₂₁ O ₆ Tb	Terbium(III) acetylacetonate trihydrate (99.9%-Tb) (REO).....	431	C ₁₆ H ₂₂ Cl ₂ Hf	Bis(i-propylcyclopentadienyl)hafnium dichloride, min. 98%.....	76
C ₁₅ H ₂₁ O ₆ Tm	Thulium(III) acetylacetonate trihydrate (99.9%-Tm) (REO).....	433	C ₁₆ H ₂₂ Cl ₂ Ti	Bis(i-propylcyclopentadienyl)titanium dichloride, min. 98%.....	439
C ₁₅ H ₂₁ O ₆ V	Vanadium(III) acetylacetonate, 98%.....	445	C ₁₆ H ₂₂ Cl ₂ Zr	Bis(i-propylcyclopentadienyl)zirconium dichloride, 98%.....	455
C ₁₅ H ₂₁ O ₆ Y	Yttrium(III) acetylacetonate hydrate (99.9%-Y) (REO).....	449	C ₁₆ H ₂₂ Cr	Bis(i-propylcyclopentadienyl)chromium, min. 98%.....	44
C ₁₅ H ₂₁ O ₆ Yb	Ytterbium(III) acetylacetonate hydrate (99.9%-Yb) (REO).....	447	C ₁₆ H ₂₂ Fe	Bis(i-propylcyclopentadienyl)iron, min. 98%.....	99
C ₁₅ H ₂₂ BKN ₆	Potassium hydrotris(3,5-dimethylpyrazol-1-yl)borate, 97%.....	343	C ₁₆ H ₂₂ Mg	Bis(n-propylcyclopentadienyl)magnesium, min. 98%.....	121
C ₁₅ H ₂₂ CIN ₂	1,3-Di-t-butylbenzimidazolium chloride, min. 97%.....	194	C ₁₆ H ₂₂ Mn	Bis(i-propylcyclopentadienyl)manganese, min. 98%.....	125
C ₁₅ H ₂₄ AuClN ₂	Chloro[1,3-bis(cyclohexyl)2H-imidazol-2-ylidene]gold(I), 98%.....	73	C ₁₆ H ₂₂ Ni	Bis(i-propylcyclopentadienyl)nickel, min. 98%.....	172
C ₁₅ H ₂₅ BF ₄ N ₂	1,3-Bis(cyclohexyl)imidazolium tetrafluoroborate, min. 97% (CYHBF ₄).....	181	C ₁₆ H ₂₄ BF ₄ Ir	Bis(1,5-cyclooctadiene)iridium(I) tetrafluoroborate, 98%.....	86
C ₁₅ H ₂₆ N ₄	N-Benzyl-1,4,7,10-tetraazacyclododecane, min. 98%.....	179	C ₁₆ H ₂₄ BF ₄ Rh	Bis(1,5-cyclooctadiene)rhodium(I) tetrafluoroborate, 98+%.....	349
C ₁₅ H ₂₇ NS ₃	2-Cyanomethyl-S-dodecyltrithiocarbonate, min. 97%.....	425	C ₁₆ H ₂₄ Cl ₂ Ir ₂	Chloro-1,5-cyclooctadiene iridium(I) dimer, 99%.....	87
C ₁₅ H ₂₇ P	Tricyclopentylphosphine, min. 95%.....	327	C ₁₆ H ₂₄ Cl ₂ Rh ₂	Chloro[1,5-cyclooctadiene]rhodium(I) dimer, 98%.....	356
C ₁₅ H ₃₂ N ₃ PO	2-Cyanoethyl N,N,N',N'-tetra(i-propyl)phosphorodiamidite, min. 98%.....	283	C ₁₆ H ₂₄ F ₆ N ₃ PRu	Tris(acetonitrile)pentamethylcyclopentadienylruthenium(II) hexafluorophosphate, min. 98%.....	400
C ₁₅ H ₃₃ NO ₃ S	3-(Decyldimethylammonio)propanesulfonate (Sulfobetaine 10).....	167	C ₁₆ H ₂₄ F ₁₂ N ₃ Rh	Tris(acetonitrile)pentamethylcyclopentadienylrhodium(III) hexafluoroantimonate, min. 98%.....	361
C ₁₅ H ₃₃ N ₄ P	2,8,9-Tri-i-propyl-2,5,8,9-tetraaza-1-phosphabicyclo[3.3.3]undecane.....	330	C ₁₆ H ₂₄ Ni	Bis(1,5-cyclooctadiene)nickel (0), 98+%.....	171
C ₁₅ H ₃₃ O ₃ P	Tri-neo-pentylphosphite, min. 90%.....	329	C ₁₆ H ₂₄ O ₂	6,7-Dimethoxy-1,1,4,4-tetramethyl-1,2,3,4-tetrahydronaphthalene, 99+% Redox shuttle ANL-RS21.....	218
C ₁₅ H ₃₃ O ₄ P	Tri-n-amyolphosphate, min. 97%.....	325	C ₁₆ H ₂₅ AgF ₇ O ₂ P	Triethylphosphine(6,6,7,7,8,8,8-heptafluoro-2,2-dimethyl-3,5-octanedionate)silver(I), min. 98%.....	415
C ₁₅ H ₃₄ O ₄ Si	Tri-t-pentoxysilanol (99.999%-Si) PURA-TREM.....	412	C ₁₆ H ₂₆ CuO ₆	Bis(t-butylacetoacetato)copper(II), 99%.....	54
C ₁₅ H ₃₄ P ₂	1,3-Bis(di-i-propylphosphino)propane, min. 98% (dipp).....	273	C ₁₆ H ₂₆ O ₂ Rh ₂	Hydroxy(1,5-cyclooctadiene)rhodium(I) dimer, min. 97%.....	358
C ₁₆ H ₆ ClF ₁₂ P	Bis(3,5-di(trifluoromethyl)phenyl)chlorophosphine, min. 98%.....	275	C ₁₆ H ₂₆ Ru	Bis(2-methylallyl)(1,5-cyclooctadiene)ruthenium(II), min. 97%.....	366
C ₁₆ H ₁₆ Mo ₂ O ₆	Cyclopentadienylmolybdenum tricarbonyl dimer, min. 98%.....	137	C ₁₆ H ₂₆ Ir ₂ N ₂ O ₈	[2-(Pyridine-2-yl)-2-propanato]iridium(IV) dimer solution 97% (1 mM in 0.1 Molar aqueous NaO ₂).....	92
C ₁₆ H ₁₆ N ₂ O ₈	3,3',5,5'-Azobenzene tetracarboxylic acid, TazbH ₄ , 97%.....	214	C ₁₆ H ₂₆ NP	[4-(N,N-Dimethylamino)phenyl]di-t-butylphosphine, min. 95% amphos.....	298
C ₁₆ H ₁₃ KO ₄ Si	Potassium bis(1,2-benzenediolato)(1,3-butadien-2-yl)silicate, min. 98%.....	409	C ₁₆ H ₂₈ N ₄ O ₈	ane-N,N',N'',N'''-tetraacetic acid, min. 98% DOTA.....	207
C ₁₆ H ₁₄ Br ₂	racemic-4,12-Dibromo[2.2]paracyclophane, min. 95%.....	39	C ₁₆ H ₂₈ O ₄ P ₂	(2,5-Dimethoxy-1,4-phenylene)bis(diethylphosphine oxide), 99+% Redox shuttle ANL-RS51.....	297
C ₁₆ H ₁₄ N ₂ O ₄ Pd	Diacetato(1,10-phenanthroline)palladium(II), 99%.....	236	C ₁₆ H ₂₈ O ₆ Ti	Titanium (di-i-propoxide)bis(acetylacetonate) (75% in isopropanol).....	441
C ₁₆ H ₁₄ N ₄	(1R,2R)-(+)-1,2-Bis(4-cyanophenyl)ethylenediamine dihydrochloride, min. 98%.....	181	C ₁₆ H ₃₀ BaO ₄	Barium 2-ethylhexanoate, ~30% in xylene (7-10% Ba).....	11
C ₁₆ H ₁₆ Br	racemic-4-Bromo[2.2]paracyclophane, min. 95%.....	38			
C ₁₆ H ₁₆ Fe	Bis(cyclooctatetraene)iron(0), min. 98%.....	94			
C ₁₆ H ₁₆ N ₂ O ₂	Ethylenebis(salicylimine), 98% SALEN.....	199			
C ₁₆ H ₁₆ O	racemic-4-Hydroxy[2.2]paracyclophane, min. 97%.....	219			
C ₁₆ H ₁₆ O ₂	racemic-4,12-Dihydroxy[2.2]paracyclophane, min. 97%.....	217			
C ₁₆ H ₁₆ S ₂	2-Phenyl-2-propylbenzodithiolate, min. 97%.....	427			

Formula Index

Formula	Description	Page
C ₁₇ H ₂₆ BN ₄ O ₄	t-Butyl-N-[4-(4,4,5,5-tetramethyl-1,3,2-dioxaborolan-2-yl)phenyl]carbamate, min. 97%	26
C ₁₇ H ₂₆ NP	1-Di-i-propylphosphino-2-(N,N-dimethylamino)-1H-indene, 99%	310
C ₁₇ H ₂₇ O ₃ P	(Sp)-Hydroxymethylphenylphosphinic acid [(1R,2S,2R)-2-propyl-5-methylcyclohexanol]ester, 99%	314
C ₁₇ H ₃₀ N ₄	N-Benzyl-1,4,8,11-tetraazacyclotetradecane, min. 98%	179
C ₁₇ H ₃₁ NS ₃	2-(2-Cyanoprop-2-yl)-S-dodecyltrithiocarbonate, min. 97%	425
C ₁₇ H ₃₂ O ₂ S ₃	2-Methyl-2-[(dodecylsulfanylthiocarbonyl)sulfanyl]propanoic acid, min. 97%	426
C ₁₇ H ₃₃ BF ₄ N ₂	C ₁₇ H ₃₃ BF ₄ N ₂ (2S,5S)-1-[(2S,5S)-2,5-Diethylpyrrolidin-1-yl]methylene)-2,5-diethylpyrrolidinium tetrafluoroborate, min. 97%	196
C ₁₇ H ₃₄ N ₂ O ₂ S	1-Butyl-2,3-dimethylimidazolium octylsulfate, 98% [BDIMIM][OC ₈ S ₄]	81
C ₁₇ H ₃₅ CINP	[2-(Dicyclohexylphosphino)ethyl]trimethylammonium chloride, min. 95%	293
C ₁₇ H ₃₆ O ₃ W	Tris(t-butoxy)(2,2-dimethylpropylidene)tungsten(VI), 98% Schrock Alkyne Metathesis Catalyst	444
C ₁₇ H ₃₇ NO ₃ S	N-Dodecyl-N,N-dimethyl-3-ammonio-1-propanesulfonate (Sulfobetaine 12)	167
C ₁₇ H ₃₈ CINOP ₂	Carbonylchlorohydrido[bis(2-di-i-propylphosphinoethyl)amine]ruthenium(II), min. 97%	368
C ₁₈ F ₁₅ B	Tris(pentafluorophenyl)borane, min. 97%	31
C ₁₈ F ₁₅ P	Tris(pentafluorophenyl)phosphine, 98%	332
C ₁₈ H ₅ F ₁₀ P	Bis(pentafluorophenyl)phenylphosphine, 97%	278
C ₁₈ H ₈ Fe ₃ O ₁₆	Iron(III) 1,3,5-benzenetricarboxylate hydrate, porous (F-free MIL-100(Fe), KRICFT F100) [Iron trimesate]	107
C ₁₈ H ₁₁ BF ₉ N ₃ O	(5aS, 10bR)-(-)-5a, 10b-Dihydro-2-(pentafluorophenyl)-4H,6H-indeno[2,1-b][1,2,4]triazolo[4,3-d][1,4]oxazinium tetrafluoroborate, min. 98%	197
C ₁₈ H ₁₂ Cl ₃ P	Tri(m-chlorophenyl)phosphine, min. 97%	326
C ₁₈ H ₁₂ Cl ₃ P	Tri(p-chlorophenyl)phosphine, 99%	326
C ₁₈ H ₁₂ F ₃ P	Tris(p-fluorophenyl)phosphine, 99%	331
C ₁₈ H ₁₂ Na ₃ O ₃ PS ₃	Tris(3-sulfonatophenyl)phosphine hydrate, sodium salt (<10% oxide)	332
C ₁₈ H ₁₂ Na ₃ O ₃ PS ₃	Tris(3-sulfonatophenyl)phosphine hydrate, sodium salt (<5% oxide)	332
C ₁₈ H ₁₂ K ₂ O ₆ PS ₂	Bis(p-sulfonatophenyl)phenylphosphine dihydrate dipotassium salt, min. 97%	279
C ₁₈ H ₁₂ K ₂ O ₆ PS ₂	Bis(p-sulfonatophenyl)phenylphosphine dihydrate dipotassium salt, 97%	279
C ₁₈ H ₁₃ P	5-Phenyl-5H-benzo[b]phosphindole, 99%	318
C ₁₈ H ₁₄ AuClO ₃ P	Chloro[diphenyl(3-sulfonatophenyl)phosphine]gold(I), sodium salt hydrate, min. 98%	74
C ₁₈ H ₁₄ BrP	2-Bromophenylidene phosphine, 98%	281
C ₁₈ H ₁₄ Cl ₂ Zr	Bis(indenyl)zirconium dichloride, min. 98%	455
C ₁₈ H ₁₄ F ₁₃ NO ₂	(4S,5R)-(-)-4-Benzyl-5-(3,3,4,4,5,5,6,6,7,7,8,8,8-tridecafluoroctyl)-2-oxazolidinone, 99%	179
C ₁₈ H ₁₄ F ₁₃ NO ₂	(4R,5S)-(+)-4-Benzyl-5-(3,3,4,4,5,5,6,6,7,7,8,8,8-tridecafluoroctyl)-2-oxazolidinone, 99%	179
C ₁₈ H ₁₄ KO ₃ PS	Diphenyl(p-sulfonatophenyl)phosphine monohydrate dimethylsulfoxide adduct, potassium salt	309
C ₁₈ H ₁₄ NaO ₃ PS	Diphenyl(m-sulfonatophenyl)phosphine dihydrate sodium salt, min. 90%	309
C ₁₈ H ₁₅ As	Triphenylarsine, min. 97%	10
C ₁₈ H ₁₅ AuClP	Chlorotriphenylphosphinegold(I), 98+ (99.9+% Au)	74
C ₁₈ H ₁₅ B	Triphenylborane, min. 95%	31
C ₁₈ H ₁₅ Bi	Triphenylbismuth, 99%	24
C ₁₈ H ₁₅ Br ₂ P	Dibromotriphenylphosphorane, 98%	285
C ₁₈ H ₁₅ Br ₂ Sb	Triphenylantimony dibromide, 98+%	9

Formula	Description	Page
C ₁₈ H ₁₆ ClGe	Triphenylgermanium chloride, 99%	70
C ₁₈ H ₁₆ ClSi	Triphenylchlorosilane, 97%	412
C ₁₈ H ₁₆ ClSn	Triphenyltin chloride, min. 95%	438
C ₁₈ H ₁₆ Cl ₂ Sb	Triphenylantimony dichloride, 99%	9
C ₁₈ H ₁₆ FSn	Triphenyltin fluoride, min. 97%	438
C ₁₈ H ₁₆ OP	Triphenylphosphine oxide, 98%	329
C ₁₈ H ₁₆ O ₃ P	Triphenylphosphite, 97%	329
C ₁₈ H ₁₆ O ₄ P	Triphenylphosphate, 98%	329
C ₁₈ H ₁₆ P	Triphenylphosphine, 99%	329
C ₁₈ H ₁₆ Sb	Triphenylantimony, 97%	9
C ₁₈ H ₁₆ BN ₄ K	Potassium diphenylbis(pyrazol-1-yl)borate, min. 98%	341
C ₁₈ H ₁₆ NP	2-Diphenylphosphino-6-methylpyridine, 98%	306
C ₁₈ H ₁₆ OSi	Triphenylsilanol, min. 98%	412
C ₁₈ H ₁₆ Si	Triphenylsilane, min. 97%	412
C ₁₈ H ₁₇ N ₃	4,4',4''-Trimethyl-2,2':6',2''-terpyridine, 98%	211
C ₁₈ H ₁₈ BN	Triphenylborane, ammonia complex, min. 98%	31
C ₁₈ H ₁₈ Cl ₂ Pd ₂	Di-μ-chlorobis[(1,2,3-η)-1-phenyl-2-propenyl]dipalladium(II), 98%	238
C ₁₈ H ₂₀ BNO	(R)-Tetrahydro-1-methyl-3,3-diphenyl-1H,3H-pyrrolo[1,2-c][1,3,2]oxazaborole, 0.9-1.1M in toluene [(R)-Methyloxazaborolidine] (R)-CBS Catalyst	28
C ₁₈ H ₂₀ BNO	(S)-Tetrahydro-1-methyl-3,3-diphenyl-1H,3H-pyrrolo[1,2-c][1,3,2]oxazaborole, 0.9-1.1M in toluene [(S)-Methyloxazaborolidine] (S)-CBS Catalyst	29
C ₁₈ H ₂₀ F ₆ O ₄ Ru	Bis(1,1,1-trifluoro-2-oxo-pentanedionato)(1,5-cyclooctadiene)ruthenium(II), 98%	366
C ₁₈ H ₂₀ N ₂ O ₆ S ₂ Pd	Bis(acetonitrile)palladium(II) p-toluenesulfonate, 98%	227
C ₁₈ H ₂₀ N ₄ O ₂	(-)-N,N'-(1R,2R)-1,2-Diaminocyclohexanediylbis(2-pyridinecarboxamide), min. 98% (R,R)-DACH-Pyridyl Trost Ligand	194
C ₁₈ H ₂₀ N ₄ O ₂	(+)-N,N'-(1S,2S)-1,2-Diaminocyclohexanediylbis(2-pyridinecarboxamide), min. 98% (S,S)-DACH-Pyridyl Trost Ligand	194
C ₁₈ H ₂₀ O ₈ PdS ₂	1,2-Bis(phenylsulfanyl)ethane palladium(II) acetate, min. 98% Christina White Catalyst	228
C ₁₈ H ₂₁ Er	Tris(methylcyclopentadienyl)erbium(III) (99.9%-Er) (REO)	62
C ₁₈ H ₂₁ NO	(2R)-(-)-N-Methyl-α,α-diphenyl-2-pyrrolidine-methanol, min. 98%	202
C ₁₈ H ₂₁ NO	(2S)-(+)-N-Methyl-α,α-diphenyl-2-pyrrolidine-methanol, min. 98%	202
C ₁₈ H ₂₁ P	Cyclohexyldiphenylphosphine, 98%	283
C ₁₈ H ₂₂ ClO ₂ P	Bis(3,5-dimethyl-4-methoxyphenyl)chlorophosphine, min. 98%	263
C ₁₈ H ₂₂ F ₆ IrN ₂ P	Bis(pyridine)(1,5-cyclooctadiene)iridium(I) hexafluorophosphate, 99%	87
C ₁₈ H ₂₂ NP	(1R,2R)-2-(Diphenylphosphino)-1-aminocyclohexane, min. 97%	303
C ₁₈ H ₂₂ NP	(1S,2S)-2-(Diphenylphosphino)-1-aminocyclohexane, min. 97%	303
C ₁₈ H ₂₄ Cl ₂ N ₂ Pd ₂	Di-μ-chlorobis[2-[(dimethylamino)methyl]phenyl]dipalladium, 99%	237
C ₁₈ H ₂₄ Cl ₄ Ru ₂	Dichloro(mesitylene)ruthenium(II) dimer, 98%	392
C ₁₈ H ₂₄ NP	(S)-1-(Diphenylphosphino)-2-amino-3,3-dimethylbutane, min. 97% (10wt% in hexanes)	303
C ₁₈ H ₂₄ NP	(R)-1-(Diphenylphosphino)-2-amino-3,3-dimethylbutane, min. 97% (10wt% in hexanes)	303
C ₁₈ H ₂₄ N ₂	4,4'-Bis(di-t-butyl)-2,2'-bipyridine, 97% DTBBPY	181
C ₁₈ H ₂₆ BF ₄ NP	(S)-1-(Diphenylphosphino)-3,3-dimethylbutan-2-aminium tetrafluoroborate, min. 97%	304
C ₁₈ H ₂₆ CIN ₂ O ₂	1-(2,4,6-Trimethylphenyl)-3-[(2S)-4-methylpentanoic acid]imidazolium chloride, min. 95%	211
C ₁₈ H ₂₆ F ₆ N ₂ PO ₂	1-(2,4,6-Trimethylphenyl)-3-[(2S)-4-methylpentanoic acid]imidazolium hexafluorophosphate, min. 95%	211
C ₁₈ H ₂₆ Cl ₂ Ti	Bis(t-butylcyclopentadienyl)titanium dichloride, min. 98%	439
C ₁₈ H ₂₆ Cl ₂ Zr	Bis(t-butylcyclopentadienyl)zirconium dichloride, min. 98%	454
C ₁₈ H ₂₆ Cl ₂ Zr	Bis(n-butylcyclopentadienyl)zirconium dichloride, min. 98%	454

Formula Index

Formula	Description	Page	Formula	Description	Page
	Bis(tetramethylcyclopentadienyl)zirconium dichloride, min. 97%.....	455	C ₁₈ H ₅₄ LaN ₃ Si ₆	Tris(N,N-bis(trimethylsilyl)amide)lanthanum(III), min. 98% (99.9%-La) (REO)	113
C ₁₈ H ₂₆ Cr	Bis(tetramethylcyclopentadienyl)chromium, min. 98%.....	45	C ₁₈ H ₅₄ N ₃ Si ₆ Y	Tris[N,N-bis(trimethylsilyl)amide]yttrium(III), min. 98% (99.9%-Y) (REO)	448
C ₁₈ H ₂₆ Mn	Bis(tetramethylcyclopentadienyl)manganese, min. 98%.....	125		Tris[N,N-bis(trimethylsilyl)amide]yttrium(III), min. 98% (99.9%-Y) (REO), 39-1500, contained in 50 ml Swagelok® cylinder (96-1070) for CVD/ALD.....	448
C ₁₈ H ₂₆ NP	N-Phenyl-2-(di-t-butylphosphino)pyrrole, 95+% [cataCXium® PTB].....	318	C ₁₉ H ₁₂ F ₃ Na ₂ O ₆	Bis(3-sulfonatophenyl)(2-trifluoromethylphenyl)phosphine, disodium dihydrate, min. 97% o-DANPHOS	279
C ₁₈ H ₂₆ N ₄	(1R,2R)-(+)-1,2-Bis(4-dimethylaminophenyl) ethylenediamine tetrahydrochloride, min. 98%.....	182	PS ₂	Bis(3-sulfonatophenyl)(4-trifluoromethylphenyl)phosphine disodium dihydrate, min. 97% p-DANPHOS.....	280
C ₁₈ H ₂₆ Ni	Bis(tetramethylcyclopentadienyl)nickel, min. 98%.....	172	C ₁₉ H ₁₄ NP	2-(Cyanophenyl)diphenylphosphine, min. 98%.....	283
C ₁₈ H ₂₇ ClN ₂ O	1-(2,4,6-Trimethylphenyl)-3-[(2S)-4-methyl-1-pentano]imidazolium chloride, min. 97%... ..	211	C ₁₉ H ₁₅ OP	2-(Diphenylphosphino)benzaldehyde, min. 97%.....	303
C ₁₈ H ₂₇ ClRu	Chloro(1,5-cyclooctadiene)(pentamethylcyclopentadienyl)ruthenium(II), 98%.....	376	C ₁₉ H ₁₆ O ₂ P	2-(Diphenylphosphino)benzoic acid, min. 97%.....	303
C ₁₈ H ₂₇ F ₆ N ₂ OP	1-(2,4,6-Trimethylphenyl)-3-[(2S)-4-methyl-1-pentano]imidazolium hexafluorophosphate, min. 97%.....	211	C ₁₉ H ₁₇ P	p-Tolyldiphenylphosphine, min. 96%.....	325
C ₁₈ H ₂₇ P	Dicyclohexylphenylphosphine, min. 95%.....	292	C ₁₉ H ₁₈ OP	Benzylidiphenylphosphine, 99%.....	251
C ₁₈ H ₂₈ N ₂ P ₂	(R,R)-(-)-2,3-Bis(t-butylmethylphosphino) quinoxaline, min. 98% (R,R)-QuinoxP*	255	C ₁₉ H ₁₈ AuP	Methyl(triphenylphosphine)gold(I), 99%.....	75
	(S,S)-(+)-2,3-Bis(t-butylmethylphosphino) quinoxaline, min. 98% (S,S)-QuinoxP*	255	C ₁₉ H ₁₈ BrP	Methyltriphenylphosphonium bromide, 98+%	316
C ₁₈ H ₂₈ OP ₂	[1-(2R,5R)-2,5-Dimethylphosphopholanyl]-[2-(2R,5R)-2,5-dimethylphospholanyl-1-oxide]benzene, min. 97%.....	299	C ₁₉ H ₁₈ NP	2-[2-(Diphenylphosphino)ethyl]pyridine, min. 97%.....	304
	[1-(2S,5S)-2,5-Dimethylphosphopholanyl]-[2-(2S,5S)-2,5-dimethylphospholanyl-1-oxide]benzene, min. 97%.....	299	C ₁₉ H ₁₉ F ₅ N ₃ OBf ₄	(5aS,6R,9S,9aR)-5a,6,7,8,9,9a-Hexahydro-6,11,11-trimethyl-2-(2,3,4,5,6-pentafluorophenyl)-6,9-methano-4H-[1,2,4] triazol[3,4-c][1,4]benzoxazinium tetrafluoroborate	200
C ₁₈ H ₂₈ P ₂	(+)-1,2-Bis(2S,5S)-2,5-dimethylphospholano)benzene, 98+% (S,S)-Me-DUPHOS.....	265	C ₁₉ H ₂₀ NO ₂ P	(11aR)-(+)-10,11,12,13-Tetrahydroindeno[7,1-de]-1,7-fg][1,3,2]dioxaphosphocin-5-dimethylamine, min. 98% (R)-SIPHOS (11aS)-(-)-10,11,12,13-Tetrahydroindeno[7,1-de]-1,7-fg][1,3,2]dioxaphosphocin-5-dimethylamine, min. 98% (S)-SIPHOS. (2R,3S)-(-)-3,4-Dihydro-3-(i-propyl)-2-phenyl-2H-pyrimido[2,1-b]benzothiazole, min. 98% HyperBTM	321
	(-)-1,2-Bis(2R,5R)-2,5-dimethylphospholano)benzene, 98+% (R,R)-Me-DUPHOS.....	265	C ₁₉ H ₂₀ N ₂ S	(4S,5R)-4,5-Diphenyl-1,2,3-oxathiazolidine-2,2-dioxide-3-carboxylic acid t-butyl ester, min. 97%.....	426
C ₁₈ H ₃₀ Ir ₂ O ₂	Di-μ-methoxobis(1,5-cyclooctadiene)diridium(II), min. 98%.....	91	C ₁₉ H ₂₁ NO ₃ S	(4R,5S)-4,5-Diphenyl-1,2,3-oxathiazolidine-2,2-dioxide-3-carboxylic acid t-butyl ester, min. 97%.....	426
C ₁₈ H ₃₀ O ₂ Rh ₂	Di-μ-methoxobis(1,5-cyclooctadiene)dirhodium(II), min. 98%.....	358	C ₁₉ H ₂₃ N ₃ O	(8a,9S)-(+)-9-Amino-cinchonan-6'-ol, min. 90%.....	178
C ₁₈ H ₃₂ O ₂ Sn	Di-n-butyltinbis(acetylacetonate)	434		(9R)-(+)-9-Amino-cinchonan-6'-ol, min. 90%.....	178
C ₁₈ H ₃₂ NaO ₂	Sodium oleate, 99%.....	169	C ₁₉ H ₂₅ BF ₃ N ₃ O ₅	[Bis(pyrazol-1-yl)(acetimino)hydridoborato] (p-cymene)ruthenium(II) trifluoromethanesulfonate	366
C ₁₈ H ₃₃ P	Tricyclohexylphosphine, 97%.....	326	RuS	(2R)-(+)-1,1-Bis(4-methoxyphenyl)-3-methyl-2-butanediamine, min. 97% (R)-DAIPEN ... (2S)-(-)-1,1-Bis(4-methoxyphenyl)-3-methyl-2-butanediamine, min. 97% (S)-DAIPEN ...	185
	Tricyclohexylphosphine (20% in toluene), min. 88%.....	326	C ₁₉ H ₂₇ ClN ₂	1,3-Dicyclohexylbenzimidazolium chloride, min. 97%.....	195
C ₁₈ H ₃₄ BF ₄ P	Tricyclohexylphosphonium tetrafluoroborate, 99%.....	326	C ₁₉ H ₂₈ NOP	N-(2-Methoxyphenyl)-2-(di-t-butylphosphino) pyrrole, min. 95% [cataCXium® POMeTB]	315
C ₁₈ H ₃₄ O ₂	Oleic acid, 99%.....	168	C ₁₉ H ₃₃ NO ₂ S ₃	4-Cyano-4-(dodecylsulfanylthiocarbonyl) sulfanylpentanoic acid, min. 97%.....	424
C ₁₈ H ₃₅ LiO ₂	Lithium stearate, min. 95%.....	118	C ₁₉ H ₃₄ F ₃ O ₃ PS	Tricyclohexylphosphonium trifluoromethanesulfonate, 99% Stabiphos	327
C ₁₈ H ₃₅ NaO ₂	Sodium stearate, tech. gr.....	420	C ₁₉ H ₃₅ Cl-CoN ₆ O ₇ P	Triethylammonium [chlorobis(dimethylglyoximate)(4-hydrogenphosphonatepyridinyl) cobaltate(III)]	52
C ₁₈ H ₃₆ FeN ₆	Tetramethylammonium ferricyanide, 98%	111	C ₁₉ H ₃₆ N ₂ P	2-(Di-t-butylphosphinomethyl)-6-(diethylaminomethyl)pyridine, 98%.....	289
C ₁₈ H ₃₆ N ₈ O ₄	1,4,8,11-Tetraazacyclotetradecane-N,N',N'',N'''-tetraacetamide, min. 98% ... (+)-1,2-Bis(2R,5R)-2,5-diethylphospholano) ethane, 98+% (R,R)-Et-BPE.....	208	C ₁₉ H ₄₂ BrN	Hexadecyltrimethylammonium bromide, 99+% CTAB	168
	(-)-1,2-Bis(2S,5S)-2,5-diethylphospholano) ethane, 98+% (S,S)-Et-BPE.....	262	C ₂₀ H ₄ F ₂₄ O ₂ Zr	Zirconium(IV) hexafluoroacetylacetonate	458
C ₁₈ H ₃₆ Zn	2,2,6,6-Bis(tetramethylpiperidine)zinc, magnesium chloride, lithium chloride complex 0.35M (12wt% ±2wt%) in toluene/tetrahydrofuran	450	C ₂₀ H ₁₂ Br ₂	racemic-2,2'-Dibromo-1,1'-binaphthyl, min. 96%.....	38
	0.35M (12wt% ±2wt%) in toluene/tetrahydrofuran	450		(1R)-2,2'-Dibromo-1,1'-binaphthalene, min. 98%.....	38
C ₁₈ H ₃₇ N	Oleylamine, min. 70%.....	168		(1S)-2,2'-Dibromo-1,1'-binaphthalene, min. 98%.....	38
	Oleylamine, min. 95%.....	168			38
C ₁₈ H ₃₈ CoN ₄	Bis(N-t-butyl-N'-ethylpropanimidamidato) cobalt(II), min. 98%.....	47			38
	Bis(N-t-butyl-N'-ethylpropanimidamidato)cobalt(II), min. 98% (99.99%-Co) PURATREM. 2,8,9-Tri-i-butyl-2,5,8,9-tetraaza-1-phosphabicyclo[3.3.3]undecane, 97%.....	47			38
C ₁₈ H ₃₈ N ₄ P	n-Octadecylphosphonic acid, min. 97% ODPA.....	316			38
C ₁₈ H ₃₉ O ₃ P	Tri-n-hexylphosphine, min. 96%.....	327			38
C ₁₈ H ₄₂ Al ₂ O ₃	Triethyl(tri-sec-butoxy)dialuminum (contains diethyl(tetra-sec-butoxy)dialuminum and tetraethyl(di-sec-butoxy)dialuminum)	4			38
C ₁₈ H ₄₂ N ₄	Tris(isobutylaminoethyl)amine, min. 97%.....	212			38
C ₁₈ H ₄₂ O ₄ P ₂	Tributyl(ethyl)phosphonium diethylphosphate, 95%.....	83			38
C ₁₈ H ₄₄ Cl ₂ N ₂ P ₂ Ru	Dichlorobis[3-(di-i-propylphosphino)propylamine]ruthenium(II), min. 97%	383			38

Formula Index

Formula	Description	Page	Formula	Description	Page
C ₂₀ H ₁₂ Br ₂ O ₂	(R)-(+)-3,3'-Dibromo-1,1'-bi-2-naphthol, min. 98%	216	C ₂₀ H ₂₀ NP	Diphenyl[4-(N,N-dimethylamino)phenyl]phosphine, min. 95%	302
	(S)-(-)-3,3'-Dibromo-1,1'-bi-2-naphthol, min. 98%	216	C ₂₀ H ₂₀ Si	Dimethylbis(indenyl)silane, min. 98%	407
	racemic-6,6'-Dibromo-1,1'-bi-2-naphthol, min. 98%	216	C ₂₀ H ₂₀ Zr	Dimethylbis(indenyl)zirconium, min. 98%	455
	(R)-(-)-6,6'-Dibromo-1,1'-bi-2-naphthol, min. 98%	216	C ₂₀ H ₂₁ N ₄ NaO ₃ S	2-[[Bis(2-pyridinylmethyl)amino]ethylamino]benzenesulfonic acid hydrate sodium salt ZX1	188
	(S)-(+)-6,6'-Dibromo-1,1'-bi-2-naphthol, min. 98%	216	C ₂₀ H ₂₁ O ₄ P	(11bS)-8,9,10,11,12,13,14,15-Octahydro-4-hydroxy-4-oxide-dinaphthol[2,1-d:1',2'-f][1,3,2]dioxaphosphepin, 98%, (99% ee)	317
	(R)-(-)-6,6'-Dibromo-1,1'-bi-2-naphthol, 98% (99% ee)	216	C ₂₀ H ₂₂ O ₂	(R)-(+)-5,5',6,6',7,7',8,8'-Octahydro-1,1'-bi-2-naphthol, 99%	220
	(S)-(+)-6,6'-Dibromo-1,1'-bi-2-naphthol, 98% (99% ee)	216		(S)-(-)-5,5',6,6',7,7',8,8'-Octahydro-1,1'-bi-2-naphthol, 99%	220
C ₂₀ H ₁₂ ClO ₂ P	(R)-(-)-4-Chlorodinaphthol[2,1-d:1',2'-f][1,3,2]dioxaphosphepin, min. 97%	283	C ₂₀ H ₂₄ Cl ₂ Zr	rac-Ethylenebis(4,5,6,7-tetrahydro-1-indenyl)zirconium dichloride	456
	(S)-(+)-4-Chlorodinaphthol[2,1-d:1',2'-f][1,3,2]dioxaphosphepin, min. 97%	283	C ₂₀ H ₂₄ N ₂ O ₆	N,N'-Di(2-hydroxybenzyl)ethylenediamine-N,N'-diacetic acid monohydrochloride hydrate HBED	197
C ₂₀ H ₁₂ F ₆ NaO ₃ PS	Bis(4-trifluoromethylphenyl)(3-sulfonatophenyl)phosphine, sodium salt, min. 97%	281	C ₂₀ H ₂₄ O ₆	Dibenzo-18-crown-6, min. 98%	216
	Bis(2-trifluoromethylphenyl)(3-sulfonatophenyl)phosphine, sodium salt, min. 97%	280	C ₂₀ H ₂₇ AuCIP	Chloro[2-(di-t-butylphosphino)-1,1'-biphenyl]gold(II), 99%	73
	o-DAN2PHOS	280	C ₂₀ H ₂₇ N ₄	(2R,2'R)-(+)-[N,N'-Bis(2-pyridylmethyl)]-2,2'-bipyrridine tetrahydrochloride, 98% (R,R)-PDP	188
C ₂₀ H ₁₃ Br	2-Bromo-1,1'-binaphthyl, 98%	38		(2S,2'S)-(-)-[N,N'-Bis(2-pyridylmethyl)]-2,2'-bipyrridine tetrahydrochloride, 98% (S,S)-PDP	188
C ₂₀ H ₁₃ F ₆ Na ₂ O ₆ PS ₂	Bis(3-sulfonatophenyl)(3,5-di-trifluoromethylphenyl)phosphine, disodium salt monohydrate, min. 97%	279	C ₂₀ H ₂₇ P	2-(Di-t-butylphosphino)-1,1'-biphenyl, 99% JohnPhos	288
	DANPHOS (water soluble)	279	C ₂₀ H ₂₈ Cl ₂ N ₂	(1R,2R)-N,N'-Bis(phenylmethyl)-1,2-cyclohexanediamine dihydrochloride, min. 98%	187
C ₂₀ H ₁₃ O ₄ P	(R)-(-)-1,1'-Binaphthyl-2,2'-diyl hydrogenphosphate, min. 98%	252		(1S,2S)-N,N'-Bis(phenylmethyl)-1,2-cyclohexanediamine dihydrochloride, min. 98%	187
	(S)-(+)-1,1'-Binaphthyl-2,2'-diyl hydrogenphosphate, min. 98%	252	C ₂₀ H ₂₈ Cl ₃ N ₃ O	(8a, 9S)-6-Methoxycinchonan-9-amine trihydrochloride, min. 90%	202
C ₂₀ H ₁₁ CIP	Bis(1-naphthyl)chlorophosphine, min. 97%	278		(8a, 9R)-6-Methoxycinchonan-9-amine trihydrochloride, min. 90%	202
C ₂₀ H ₁₄ O ₂	R-(+)-1,1'-Bi-2-naphthol, 99% (R)-BINOL	214	C ₂₀ H ₂₈ Cl ₄ Ru ₂	Di-μ-chloro[is(p-cymene)chlororuthenium(II)], min. 98%	383
	S-(-)-1,1'-Bi-2-naphthol, 99% (S)-BINOL	214	C ₂₀ H ₂₈ HfO ₈	Hafnium(IV) acetylacetonate, min. 96%	77
	racemic-1,1'-Bi-2-naphthol, 99% rac-BINOL	214	C ₂₀ H ₂₈ O ₆ Zr	Zirconium(IV) acetylacetonate, min. 98%	457
C ₂₀ H ₁₆ AuF ₆ NO ₄ PS ₂	Triphenylphosphinegold(I) bis(trifluoromethanesulfonyl)imide, min. 98%	76	C ₂₀ H ₃₀ Ba	Bis(pentamethylcyclopentadienyl)barium, 98%	12
	cis-Dichlorobis(2,2'-bipyridine)ruthenium(II) dihydrate, 99%	383	C ₂₀ H ₃₀ ClOP	Di-1-adamantylphosphinic chloride, 98%	284
C ₂₀ H ₁₆ Cl ₂ Zr	rac-Ethylenebis(indenyl)zirconium(IV) dichloride	456	C ₂₀ H ₃₀ CIP	Di-1-adamantylchlorophosphine, min. 97%	284
C ₂₀ H ₁₆ F ₁₂ O ₆ Zr	Zirconium(IV) trifluoroacetylacetonate, 99%	458	C ₂₀ H ₃₀ Cl ₂ Hf	Bis(pentamethylcyclopentadienyl)hafnium dichloride, min. 98%	76
C ₂₀ H ₁₆ N ₂	racemic-2,2'-Diamino-1,1'-binaphthyl, min. 96%	193	C ₂₀ H ₃₀ Cl ₂ Ti	Bis(pentamethylcyclopentadienyl)titanium dichloride, 99%	439
	(R)-(+)-2,2'-Diamino-1,1'-binaphthyl, 99%	193	C ₂₀ H ₃₀ Cl ₂ Zr	Bis(pentamethylcyclopentadienyl)zirconium dichloride, 99%	455
	(S)-(-)-2,2'-Diamino-1,1'-binaphthyl, 99%	193	C ₂₀ H ₃₀ Cl ₃ N ₃ O	(8a, 9S)-10,11-Dihydro-6'-methoxycinchonan-9-amine trihydrochloride, min. 90%	196
C ₂₀ H ₁₈ Cl ₂ SiZr	rac-Dimethylsilylbis(1-indenyl)zirconium dichloride, min. 97%	456		(9R)-10,11-Dihydro-6'-methoxycinchonan-9-amine trihydrochloride, min. 90%	196
C ₂₀ H ₁₈ Cl ₂ Zr	Bis(2-methylindenyl)zirconium dichloride, 98%	455	C ₂₀ H ₃₀ Cl ₄ Ir ₂	Dichloro(pentamethylcyclopentadienyl)iridium(III) dimer, 98%	90
C ₂₀ H ₁₈ O ₂ Sn	Triphenyltin acetate, 97%	438	C ₂₀ H ₃₀ Cl ₄ Rh ₂	Dichloro(pentamethylcyclopentadienyl)rhodium(III) dimer, 99%	357
C ₂₀ H ₁₈ O ₄ P	2-(Diphenylphosphino)terephthalic acid, 98%	309	C ₂₀ H ₃₀ CoF ₆ P	Bis(pentamethylcyclopentadienyl)cobalt(III) hexafluorophosphate, 98%	47
C ₂₀ H ₁₉ O ₂ P	Bis(2-methoxyphenyl)phenylphosphine, min. 98%	278	C ₂₀ H ₃₀ Cr	Bis(pentamethylcyclopentadienyl)chromium, min. 95%	44
C ₂₀ H ₂₀ BaF ₁₄ O ₄	Bis(6,6,7,7,8,8,8-heptafluoro-2,2-dimethyl-3,5-octanedionate)barium [Ba(FOD) ₂]	12	C ₂₀ H ₃₀ Fe	Bis(pentamethylcyclopentadienyl)iron, 99%	99
C ₂₀ H ₂₀ BrP	Ethyltriphenylphosphonium bromide, 99%	312	C ₂₀ H ₃₀ Mg	Bis(pentamethylcyclopentadienyl)magnesium, elec. gr. (99.999%-Mg) PURATREM	121
C ₂₀ H ₂₀ Br ₂ O ₂	(R)-(+)-3,3'-Dibromo-5,5',6,6',7,7',8,8'-octahydro-1,1'-bi-2-naphthol, 99%	217		Bis(pentamethylcyclopentadienyl)magnesium, min. 98%	121
	(S)-(-)-3,3'-Dibromo-5,5',6,6',7,7',8,8'-octahydro-1,1'-bi-2-naphthol, 99%	217	C ₂₀ H ₃₀ Mn	Bis(pentamethylcyclopentadienyl)manganese, min. 98%	125
C ₂₀ H ₂₀ CaF ₁₄ O ₄	Bis(6,6,7,7,8,8,8-heptafluoro-2,2-dimethyl-3,5-octanedionate)calcium [Ca(FOD) ₂]	34	C ₂₀ H ₃₀ Ni	Bis(pentamethylcyclopentadienyl)nickel, 98%	172
C ₂₀ H ₂₀ CuF ₁₄ O ₄	Bis(6,6,7,7,8,8,8-heptafluoro-2,2-dimethyl-3,5-octanedionate)copper(II) [Cu(FOD) ₂]	55	C ₂₀ H ₃₀ Os	Bis(pentamethylcyclopentadienyl)osmium, 99% (99.9%-Os) (Decamethyloscocene)	213
C ₂₀ H ₂₀ F ₁₄ O ₄ Sr	Bis(6,6,7,7,8,8,8-heptafluoro-2,2-dimethyl-3,5-octanedionate)strontium hydrate [Sr(FOD) ₂]	422	C ₂₀ H ₃₀ Ru	Bis(pentamethylcyclopentadienyl)ruthenium, 99% (99.9%-Ru) (Decamethylruthococene)	366
C ₂₀ H ₂₀ NP	(R)-1-[2-(Diphenylphosphino)phenyl]ethylamine, min. 97%	308			
	(S)-1-[2-(Diphenylphosphino)phenyl]ethylamine, min. 97%	308			
	(R)-2-(Diphenylphosphino)-1-phenylethylamine, min. 97%	308			
	(S)-2-(Diphenylphosphino)-1-phenylethylamine, min. 97%	308			

Formula Index

Formula	Description	Page	Formula	Description	Page
C ₂₀ H ₃₁ B ₂ F ₈ N ₂ P	2-Diethylphosphino-2',6'-bis(dimethylamino)-1,1'-biphenyl di(hydrogen tetrafluoroborate) salt, min. 98% EtCPhos	296	C ₂₁ H ₂₁ O ₃ P	Tris(o-methoxyphenyl)phosphine, min. 98%	332
C ₂₀ H ₃₁ OP	Di-1-adamantylphosphine oxide, min. 90%	284	C ₂₁ H ₂₁ P	Tris(m-methoxyphenyl)phosphine, 97+%	332
C ₂₀ H ₃₁ P	Di-1-adamantylphosphine, min. 97%	284	C ₂₁ H ₂₁ P	Tris(p-methoxyphenyl)phosphine, 98%	332
C ₂₀ H ₃₂ Cl ₂ Ru ₂	Dichlorobis(μ-chloro)bis(1,2,3,6,7,8- <i>s</i> -#8776)-2,7-dimethyl-2,6-octadien-1,8-diyl]diruthenium(IV), 99%	383	C ₂₁ H ₂₂ NP	Tri-o-tolylphosphine, 99%	333
C ₂₀ H ₃₂ Hf	Dimethylbis(t-butylcyclopentadienyl)hafnium(IV), min. 98%	76	C ₂₁ H ₂₂ NP	Tri-m-tolylphosphine, 98%	332
C ₂₀ H ₃₂ Ti	Dimethylbis(t-butylcyclopentadienyl)titanium(IV), min. 98%	439	C ₂₁ H ₂₂ NP	Tri-p-tolylphosphine, 98%	332
C ₂₀ H ₃₂ Zr	Dimethylbis(t-butylcyclopentadienyl)zirconium, min. 98%	455	C ₂₁ H ₂₂ NP	Tribenzylphosphine, 98%	325
C ₂₀ H ₃₄ MnO ₄	Manganese(II) cyclohexanebutyrate	126	C ₂₁ H ₂₂ N ₂ O ₂	(1R,2R)-2-Amino-1-phenylpropyldiphenylphosphine, min. 97%	250
C ₂₀ H ₃₄ NiO ₄	Nickel(II) cyclohexanebutyrate (AAS)	175	C ₂₁ H ₂₂ N ₂ O ₂ S	(1S,2S)-2-Amino-1-phenylpropyldiphenylphosphine, min. 97%	250
C ₂₀ H ₃₄ O ₄	1,4-Di-t-butyl-2,5-bis(2-methoxyethoxy)benzene, 99+% Redox shuttle ANL-RS2	217	C ₂₁ H ₂₂ N ₂ O ₂ S	(-)-2,2-Bis[(4S)-4-phenyl-2-oxazolin-2-yl]propane, 98%	187
C ₂₀ H ₃₄ O ₄ Zn	Zinc cyclohexanebutyrate dihydrate (AAS)	452	C ₂₁ H ₂₂ N ₂ O ₂ S	(1R,2R)-(-)-N-(4-toluenesulfonyl)-1,2-diphenylethylenediamine, 98% (R,R)-TsDPEN	210
C ₂₀ H ₃₂ N ₂ OPRu	Carbonylhydrido[6-(di-t-butylphosphinomethylene)-2-(N,N-diethylaminomethyl)-1,6-dihydropyridine]ruthenium(II), min. 98% Milstein Catalyst	369	C ₂₁ H ₂₂ N ₂ O ₂ S	(1S,2S)-(+)-N-(4-toluenesulfonyl)-1,2-diphenylethylenediamine, 98% (S,S)-TsDPEN	210
C ₂₀ H ₃₆ ClN ₂ OPRu	Carbonylchlorohydrido[6-(di-t-butylphosphinomethyl)-2-(N,N-diethylaminomethyl)pyridine]ruthenium(II), min. 98% (Milstein Catalyst Precursor)	369	C ₂₁ H ₂₃ BF ₄ NP	(1R,2R)-1-(Diphenylphosphino)-1-phenylpropan-2-ammonium tetrafluoroborate, min. 97%	308
C ₂₀ H ₃₆ NaO ₇ S	Sodium dioctylsulfosuccinate (AOT), min. 95%	168	C ₂₁ H ₂₃ ClIrN	Chloro(pentamethylcyclopentadienyl)[(2-pyridinyl-kN)phenyl-kC]iridium(III), 99%	88
C ₂₀ H ₃₆ O ₄ P ₂	(2,5-Dimethoxy-1,4-phenylene)bis(di-i-propylphosphine oxide), 99+% Redox shuttle ANL-RSS	297	C ₂₁ H ₂₃ O ₂ P	(11aR)-(+)-10,11,12,13-Tetrahydro-5-(1,1-dimethylethyl)indeno[7,1-de,1',7'-fg][1.3.2]dioxaphosphocin, 97% (S)-FuP-tBu	322
C ₂₀ H ₃₇ O ₃ PS	Tri-i-butyl(methyl)phosphonium tosylate, min. 95%	83	C ₂₁ H ₂₄ AuCIN ₂	Chloro[1,3-bis(2,4,6-trimethylphenyl)2H-imidazol-2-ylidene]gold(I), 98%	73
C ₂₀ H ₃₈ BaO ₄	Barium neodecanoate, superconductor grade (25-29% Ba)	12	C ₂₁ H ₂₄ CIN ₂ O ₃ Re	Chlorotricarbonyl(4,4'-di-t-butyl-2,2'-bipyridine)rhenium(I), 99%	347
C ₂₀ H ₃₈ CaO ₄	Calcium neodecanoate, superconductor grade (9-11% Ca)	35	C ₂₁ H ₂₄ N ₂	1,3-Bis(2,4,6-trimethylphenyl)imidazol-2-ylidene, min. 98%	189
C ₂₀ H ₃₈ CuO ₄	Copper(II) neodecanoate, superconductor grade, ~60% in toluene (6-12% Cu)	57	C ₂₁ H ₂₆ CIN ₂	1,3-Bis(2,4,6-trimethylphenyl)imidazolium chloride, min. 97%	189
C ₂₀ H ₃₈ O ₄ Sr	Strontium neodecanoate, superconductor grade (16-21% Sr)	423	C ₂₁ H ₂₆ AuCIN ₂	Chloro[1,3-bis(2,4,6-trimethylphenyl)-4,5-dihydroimidazol-2-ylidene]gold(I), 98%	73
C ₂₀ H ₄₂ Cu ₂ N ₄	Bis(N,N'-di-sec-butylacetamidato)dicopper(I), 99%	54	C ₂₁ H ₂₆ N ₂	1,3-Bis(2,4,6-trimethylphenyl)-4,5-dihydroimidazol-2-ylidene, min. 98%	189
C ₂₀ H ₄₂ MgN ₄	Bis(N,N'-di-sec-butylacetamidato)magnesium, 99%	120	C ₂₁ H ₂₆ O ₈ S ₂	N-3-[(2,6-Dimethylphenyl)amino]-1-methyl-2-buten-1-ylidene)-2,6-dimethylbenzenamine, 98%	197
C ₂₀ H ₄₂ N ₄ Fe	Bis(N,N'-di-t-butylacetamidato)iron(II), min. 98%	95	C ₂₁ H ₂₆ O ₈ S ₂	(4S,5S)-(+)-O-Isopropylidene-2,3-dihydroxy-1,4-bis(p-tosyl)butane	39
C ₂₀ H ₄₂ N ₄ Ni	Bis(N,N'-di-t-butylacetamidato)iron(II), min. 98%, 26-0145, contained in 50 ml Swagelok® (96-1070) cylinder for CVD/ALD	95	C ₂₁ H ₂₆ O ₈ S ₂	(4R,5R)-(-)-O-Isopropylidene-2,3-dihydroxy-1,4-bis(p-tosyl)butane	39
C ₂₀ H ₄₂ N ₄ Ni	Bis(N,N'-di-t-butylacetamidato)nickel(II), (99.999%-Ni) PURATREM	172	C ₂₁ H ₂₇ BF ₄ N ₂	1,3-Bis(2,4,6-trimethylphenyl)-4,5-dihydroimidazolium tetrafluoroborate, min. 95%	189
C ₂₀ H ₄₂ NP ₂	Bis[2-(di-t-butylphosphino)ethyl]amine, min. 97% (10wt% in hexanes)	257	C ₂₁ H ₂₇ CIN ₂	SIMes-HBF ₄	189
C ₂₀ H ₄₅ O ₅ Ta	Tantalum(V) n-butoxide (99.99%-Ta) PURATREM	429	C ₂₁ H ₂₉ P	1,3-Bis(2,4,6-trimethylphenyl)-4,5-dihydroimidazolium chloride, min. 97%	189
C ₂₀ H ₄₆ B ₂ F ₈ P ₂	1,4-Bis(di-t-butylphosphonium)butane bis(tetrafluoroborate), min. 97%	258	C ₂₁ H ₂₉ P	2-Di-t-butylphosphino-2'-methyl)-1,1'-biphenyl, 99% t-BuMPhos	289
C ₂₀ H ₄₆ Cl ₂ N ₂ P ₂ Ru	Dichlorobis[2-(di-t-butylphosphino)ethylamine]ruthenium(II), min. 97%	382	C ₂₁ H ₃₁ O ₃ PSi	Diphenyl[3-(triethoxysilyl)propyl]phosphine, 98%	309
C ₂₁ H ₁₂ F ₆ P	Tris(p-trifluoromethylphenyl)phosphine, min. 97%	332	C ₂₁ H ₃₃ Nb	Trihydrido(bis(pentamethylcyclopentadienyl)niobium(IV))	178
C ₂₁ H ₁₃ F ₆ O ₂ P	Bis(4-trifluoromethylphenyl)(4-carboxyphenyl)phosphine, min. 97% p-Miranphos	280	C ₂₁ H ₃₄ BF ₄ O ₃ P	[2,4,6-Trimethoxyphenyl]dicyclohexylphosphonium tetrafluoroborate, 98% LB-PhosHBF ₄	328
C ₂₁ H ₁₄ F ₃ O ₄ P	Bis(3-trifluoromethylphenyl)(3-carboxyphenyl)phosphine, min. 97% m-Miranphos	280	C ₂₁ H ₃₅ F ₆ N ₃ P ₂ Ru	Acetonitrile(cyclopentadienyl)[2-(di-i-propylphosphino)-4-(t-butyl)-1-methyl-1H-imidazole] ruthenium(II) hexafluorophosphate, min. 98% [Alkene Zipper Catalyst]	363
C ₂₁ H ₁₄ F ₃ O ₄ P	Bis(4-carboxyphenyl)(4-trifluoromethylphenyl)phosphine, min. 97% p-Miran2phos	256	C ₂₁ H ₃₅ O ₂ Rh	Acetylacetonatobis(cyclooctene)rhodium(II), min. 97%	348
C ₂₁ H ₁₆ N ₂ OP	Bis(3-carboxyphenyl)(3-trifluoromethylphenyl)phosphine, min. 97% m-Miran2phos	256	C ₂₁ H ₃₈ N ₆ O ₄ P	1-Methyl-3-propylimidazolium phosphate, 99%	83
C ₂₁ H ₁₆ BN ₆ TI	Thallium hydrotris(indazol-2-yl)borate, min. 98%	432	C ₂₁ H ₄₅ LaN ₆	Tris(N,N'-di-i-propylformamidinato)lanthanum(III), (99.999%-La) PURATREM La-FMD	113
C ₂₁ H ₁₆ OP	2-(Di-p-tolylphosphino)benzaldehyde, min. 97%	311	C ₂₁ H ₄₅ N ₆ Y	Tris(N,N'-di-i-propylformamidinato)yttrium(III), 97%	448
C ₂₁ H ₁₈ BrP	Allyltriphenylphosphonium bromide, 99%	250	C ₂₁ H ₄₆ CINOP ₂	Carbonylchlorohydrido[bis(2-di-t-butylphosphinoethyl)amine]ruthenium(II), min. 97%	368
C ₂₁ H ₂₀ NP	(1R,2R)-2-(Diphenylphosphino)-2,3-dihydro-1H-inden-1-amine, min. 97% (10wt% in THF)	303			

Formula Index

Formula	Description	Page
C ₂₁ H ₄₆ P ₂	1,5-Bis(di-t-butylphosphino)pentane, min. 97%	257
C ₂₂ H ₁₀ F ₁₂ NaO ₃ PS	Bis(3,5-di-trifluoromethylphenyl)(3-sulfonaphenyl)phosphine, sodium salt, min. 97% DAN2PHOS.....	276
C ₂₂ H ₁₂ F ₆ O ₆ S ₂	(R)-(-)-1,1'-Bi-2-naphthol bis(trifluoromethanesulfonate), 98%	214
	(S)-(+)-1,1'-Bi-2-naphthol bis(trifluoromethanesulfonate), 98%	215
C ₂₂ H ₁₈ NO ₂ P	(R)-(-)-(3,5-Dioxa-4-phospha-cyclohepta[2,1-a;3,4-a']dinaphthalen-4-yl)dimethylamine, min. 97% (R)-MONOPHOS.....	302
	(S)-(+)-(3,5-Dioxa-4-phospha-cyclohepta[2,1-a;3,4-a']dinaphthalen-4-yl)dimethylamine, min. 97% (S)-MONOPHOS.....	302
C ₂₂ H ₂₀ N ₂	meso-1,2-Bis(naphthyl)ethylenediamine, min. 98%	187
C ₂₂ H ₂₀ N ₄ P ₂	1,2-Bis(di-2-pyridylphosphino)ethane, min. 98%	274
C ₂₂ H ₂₂ Cl ₂ N ₂ O ₄ Ru	Chloro(4,4'-dicarboxy-2,2'-bipyridine)(p-cymene)ruthenium(II) chloride, min. 98%	377
C ₂₂ H ₂₂ NP	(R)-1-Amino-8-(diphenylphosphino)-1,2,3,4-tetrahydronaphthalene, min. 97%	250
	(S)-1-Amino-8-(diphenylphosphino)-1,2,3,4-tetrahydronaphthalene, min. 97%	250
	9-[2-(Diethylphosphino)phenyl]-9H-carbazole, min. 97% Et PhenCar-Phos.....	296
C ₂₂ H ₂₃ BF ₄ NP	(R)-8-(Diphenylphosphino)-1,2,3,4-tetrahydronaphthalenamime tetrafluoroborate, min. 97%	309
C ₂₂ H ₂₃ BO ₅	7-[[4,4,5,5-Tetramethyl-1,3,2-dioxaborolan-2-yl]benzyl]oxy-2H-1-benzopyran-2-one CBBE.....	29
C ₂₂ H ₂₄ F ₈ N ₂ O ₄ S ₂ Zn	Bis[4,4,4-trifluoro-1-(2-thienyl)-1,3-butanedionato]zinc TMEDA adduct, 99%	451
C ₂₂ H ₂₆ NO ₂ P	(S)-(+)-(8,9,10,11,12,13,14,15-Octahydro-3,5-dioxa-4-phospha-cyclohepta[2,1-a;3,4-a']dinaphthalen-4-yl)dimethylamine, 99%	317
C ₂₂ H ₂₆ NO ₂ PS	4-Butyl-N-(diphenylphosphino)benzenesulfonamide, min. 97%	282
C ₂₂ H ₂₆ N ₂ O ₃	1,3-Bis(2,4,6-trimethylphenyl)imidazolium bicarbonate, min. 97% IMesH.HCO ₃	189
C ₂₂ H ₂₆ FeN ₂	(R)-(+)-4-Pyrrolidinopyrindinyl(pentamethacyclopentadienyl) iron, min. 98% (R)-PPY*.....	110
	(S)-(-)-4-Pyrrolidinopyrindinyl(pentamethacyclopentadienyl)iron, min. 98% (S)-PPY*.....	110
C ₂₂ H ₂₈ NP	N-Phenyl-2-(di-t-butylphosphino)indol, min. 98% [cataCXium® PIntB].....	318
C ₂₂ H ₂₉ BF ₄ N ₂	1-(2,4,6-Trimethylphenyl)-3-(adamantyl)imidazolium tetrafluoroborate, min. 97%	210
C ₂₂ H ₂₉ ClN ₂	1-(2,4,6-Trimethylphenyl)-3-(adamantyl)imidazolium chloride, min. 97%	210
C ₂₂ H ₂₉ O ₂ PPd	Acetato(2'-di-t-butylphosphino-1,1'-biphenyl-2-yl)palladium(II), min. 98%	225
C ₂₂ H ₂₉ P	(S)-(+)-Neomenthyl(diphenylphosphine), 98% (S)-NMDPP.....	316
C ₂₂ H ₃₀ F ₆ AuNP	2-(Di-t-butylphosphino)-1,1'-biphenyl(acetonitrile)gold(II) hexafluoroantimonate, 99%	74
C ₂₂ H ₃₀ NP	N-Phenyl-2-(dicyclohexylphosphino)pyrrole, 90% [cataCXium® PCy].....	318
C ₂₂ H ₃₀ N ₃ OBF ₄	(5aS,6R,9S,9aR)-5a,6,7,8,9,9a-Hexahydro-6,11,11-trimethyl-2-(2,4,6-trimethylphenyl)-6,9-methano-4H-[1,2,4]triazolo[3,4-c][1,4]benzoxazinium tetrafluoroborate.....	201
C ₂₂ H ₃₁ BF ₄ N ₂	1-(2,4,6-Trimethylphenyl)-3-[(1R,2R,3R,5S)-(-)-isopinocampheyl]imidazolium tetrafluoroborate, min. 95%	211
	1-(2,4,6-Trimethylphenyl)-3-[(1R,2R,3R,5S)-(-)-isopinocampheyl]imidazolium chloride, min. 95%	211
C ₂₂ H ₃₂ FeP ₂	1,1'-Bis(2R,5R)-2,5-dimethylphospholano ferrocene, min. 97%	97
	1,1'-Bis(2S,5S)-2,5-dimethylphospholano ferrocene, min. 97%	97

Formula	Description	Page
C ₂₂ H ₃₂ NP	2-Di-t-butylphosphino-2'-(N,N-dimethylamino)-1,1'-biphenyl, 98% tBuDavePhos.....	289
C ₂₂ H ₃₃ O ₄ PPd	Di(acetato)dicyclohexylphenylphosphinepalladium(II) (~5% Pd) polymer-bound FibreCat™.....	235
C ₂₂ H ₃₆ Cl ₂ FeP ₂ Pd	Dichloro[di(1,1'-bis(di-n-propylphosphino)ferrocene)palladium(II)], 99%	238
C ₂₂ H ₃₆ Cl ₂ Ru ₂ S ₂	Dichlorobis(μ-methanethioato)bis(pentamethylcyclopentadienyl)ruthenium(III), 99% (minimum 90% syn isomer).....	391
C ₂₂ H ₃₆ FeP ₂	1,1'-Bis(di-n-propylphosphino)ferrocene, min. 98% DIPP.....	98
	1,2-Diiodo-4,5-di-n-octyloxybenzene.....	218
C ₂₂ H ₃₆ I ₂ O ₂	[1-(2R,5R)-2,5-Diethylphospholanyl]-[2-(2R,5R)-2,5-diethylphospholanyl-1-oxide]benzene, min. 97%	296
C ₂₂ H ₃₆ OP ₂	[1-(2S,5S)-2,5-Diethylphospholanyl]-[2-(2S,5S)-2,5-diethylphospholanyl-1-oxide]benzene, min. 97%	296
C ₂₂ H ₃₆ P ₂	(-)-1,2-Bis((2R,5R)-2,5-diethylphospholano)benzene, 98+% (R,R)-Et-DUPHOS.....	262
	(+)-1,2-Bis((2S,5S)-2,5-diethylphospholano)benzene, 98+% (S,S)-Et-DUPHOS.....	262
C ₂₂ H ₃₆ Zr	Bis(pentamethylcyclopentadienyl)dimethylzirconium(IV), 99%	455
C ₂₂ H ₃₈ BaO ₄	Bis(2,2,6,6-tetramethyl-3,5-heptanedionato)barium hydrate [Ba(TMHD)] ₂	13
	Bis(2,2,6,6-tetramethyl-3,5-heptanedionato)barium tetraglyme adduct (99.99%-Ba, Sr-0.5%) PURATREM.....	13
	Bis(2,2,6,6-tetramethyl-3,5-heptanedionato)barium triglyme adduct(99.99%-Ba, Sr-0.5%) PURATREM.....	13
C ₂₂ H ₃₈ CaO ₄	Bis(2,2,6,6-tetramethyl-3,5-heptanedionato)calcium, min. 97% [Ca(TMHD)] ₂	34
C ₂₂ H ₃₈ Cl ₂ O ₄ Ti	Dichlorobis(2,2,6,6-tetramethyl-3,5-heptanedionato)titanium(IV), 99%	439
C ₂₂ H ₃₈ CuO ₄	Bis(2,2,6,6-tetramethyl-3,5-heptanedionato)copper(II), 99% [Cu(TMHD)] ₂	55
C ₂₂ H ₃₈ MgO ₄	Bis(2,2,6,6-tetramethyl-3,5-heptanedionato)magnesium, anhydrous, min. 98% [Mg(TMHD)] ₂	121
	Bis(2,2,6,6-tetramethyl-3,5-heptanedionato)magnesium dihydrate, min. 98% [Mg(TMHD)] ₂	121
	Bis(2,2,6,6-tetramethyl-3,5-heptanedionato)magnesium, anhydrous, min. 98% [Mg(TMHD)] ₂ , 12-0900, contained in high-temp 50 ml Swagelok® cylinder (96-1071) for CVD/ALD.....	121
C ₂₂ H ₃₈ MoO ₆	Molybdenum(IV) dioxide bis(2,2,6,6-tetramethyl-3,5-heptanedionato), min. 98% [O ₂ Mo(TMHD)] ₂	138
C ₂₂ H ₃₈ NiO ₄	Bis(2,2,6,6-tetramethyl-3,5-heptanedionato)nickel(II), min. 98% (99.9%-Ni) [Ni(TMHD)] ₂	172
C ₂₂ H ₃₈ O ₄ Pb	Bis(2,2,6,6-tetramethyl-3,5-heptanedionato)lead(II), 99% [Pb(TMHD)] ₂	114
C ₂₂ H ₃₈ O ₄ Pd	Bis(2,2,6,6-tetramethyl-3,5-heptanedionato)palladium(II), min. 98% [Pd(TMHD)] ₂	228
C ₂₂ H ₃₈ O ₄ Sr	Bis(2,2,6,6-tetramethyl-3,5-heptanedionato)strontium hydrate [Sr(TMHD)] ₂	422
	Bis(2,2,6,6-tetramethyl-3,5-heptanedionato)strontium tetraglyme adduct (99.99%-Sr) PURATREM.....	422
	Bis(2,2,6,6-tetramethyl-3,5-heptanedionato)zinc, 99% [Zn(TMHD)] ₂	450
C ₂₂ H ₃₈ O ₅ Ti	Bis(2,2,6,6-tetramethyl-3,5-heptanedionato)oxotitanium(IV), min. 95% [OTi(TMHD)] ₂	439
C ₂₂ H ₄₀ BF ₄ P ₂ Rh	(+)-1,2-Bis(2R,5R)-2,5-dimethylphospholano)ethane(1,5-cyclooctadiene)rhodium(II) tetrafluoroborate, 98+% (R,R)-Me-BPE-Rh... (-)-1,2-Bis((2S,5S)-2,5-dimethylphospholano)ethane(1,5-cyclooctadiene)rhodium(II) tetrafluoroborate, 98+% (S,S)-Me-BPE-Rh... ..	351
C ₂₂ H ₄₀ O ₈ P ₂	2,5-Di-t-butyl-1,4-phenylene tetraethyl bis(phosphonate), 99+% Redox shuttle ANL-RS6.....	288

Formula Index

Formula	Description	Page
C ₂₂ H ₄₂ B ₂ F ₆ P ₂	1,2-Bis(dicyclopentylphosphonium)ethane bis(tetrafluoroborate), min. 97%	259
C ₂₂ H ₄₄ BF ₄ P ₂ Rh	(R)-(-)-t-Butylmethyl(di-t-butylphosphino)rhodium(I) tetrafluoroborate, min. 97%	355
C ₂₂ H ₄₄ P ₂	1,2-Bis(2R,5R)-2,5-di-i-propylphospholano)ethane, 96%	274
	1,2-Bis(2S,5S)-2,5-di-i-propylphospholano)ethane, min. 97%	274
C ₂₂ H ₄₆ MnN ₄	Bis(N,N-di-i-propylpentylamidinato)manganese(II), min. 98%	124
C ₂₂ H ₅₂ Cl ₂ N ₂ P ₂ Ru	Dichlorobis[3-(di-t-butylphosphino)propylamine]ruthenium(II), min. 97%	382
C ₂₃ H ₁₉ N ₃ O ₂	(+)-2,6-Bis[(4R)-4-phenyl-2-oxazolin-2-yl]pyridine, 98+% (R,R)-Ph-pybox	187
	(-)-2,6-Bis[(4S)-4-phenyl-2-oxazolin-2-yl]pyridine, 98+% (S,S)-Ph-pybox	187
C ₂₃ H ₁₉ O ₃ P	(11aR)-(+)-10,11,12,13-Tetrahydroindeno[7,1-de:1',7'-fg][1,3,2]dioxaphosphocin-5-phenoxy, min. 98% (R)-ShiP	322
	(11aS)-(-)-10,11,12,13-Tetrahydroindeno[7,1-de:1',7'-fg][1,3,2]dioxaphosphocin-5-phenoxy, min. 98% (S)-ShiP	322
C ₂₃ H ₂₂ BNO	(R)-Tetrahydro-1,3,3-triphenyl-1H,3H-pyrrolo[1,2-c][1,3,2]oxaborole, 99% (R)-Phenyl oxazaborolidine	29
C ₂₃ H ₂₂ NP	1-Diphenylphosphino-2-(N,N-dimethylamino)-1H-indene, 99% (contains vinylic isomer)	304
C ₂₃ H ₂₃ N ₃	2,6-Bis[1-(2-methylphenylimino)ethyl]pyridine, 98%	186
C ₂₃ H ₂₃ OP	2-[Bis(3,5-dimethylphenyl)phosphino]benzaldehyde, min. 97%	264
C ₂₃ H ₂₇ Br ₂ CN ₂ Si	(1R,2R)-[1,2-Cyclohexanedi-amino-N,N'-bis(4-bromobenzyl)allylchlorosilane, min. 98%	406
C ₂₃ H ₃₁ P	Di-t-butyl(2,2-diphenyl-1-methylvinyl)phosphine, min. 98% vBRIDP	287
C ₂₃ H ₃₂ AuClIN ₂	Chloro[1,3-bis(adamantyl)2H-imidazol-2-ylidene]gold(I), 98%	73
C ₂₃ H ₃₂ NOP	1-(2-Methoxyphenyl)-2-(dicyclohexylphosphino)pyrrole, min. 95% [cataCXium® POMeCy]	315
C ₂₃ H ₃₂ N ₂	1,3-Bis(1-adamantyl)imidazol-2-ylidene, min. 98% ARDUENGO'S CARBENE	180
C ₂₃ H ₃₃ ClN ₂	1,3-Bis(1-adamantyl)imidazolium chloride, min. 97%	180
C ₂₃ H ₃₆ ClN ₂	1,3-Bis(1-adamantyl)-4,5-dihydroimidazolium chloride, min. 97%	180
C ₂₃ H ₃₇ Cl ₂ N	2-[2,6-Bis(1-methylphenyl)phenyl]-3,3-dimethyl-2-azoniaspiro[4.5]dec-1-ene hydrogen dichloride, min. 97% Cyclohexyl-CAAC	186
C ₂₃ H ₄₀ F ₃ O ₃ P ₂ RhS	1,2-Bis(2R,5R)-2,5-dimethylphospholano)ethane(cyclooctadiene)rhodium(I) trifluoromethanesulfonate	351
	1,2-Bis(2S,5S)-2,5-dimethylphospholano)ethane(cyclooctadiene)rhodium(I) trifluoromethanesulfonate	351
C ₂₃ H ₄₃ NP ₂	2,6-Bis(di-t-butylphosphinomethyl)pyridine, 99%	257
C ₂₃ H ₄₄ B ₂ F ₆ P ₂	1,3-Bis(dicyclopentylphosphonium)propane bis(tetrafluoroborate), min. 97%	259
C ₂₄ H ₉ F ₁₈ P	Tris[3,5-bis(trifluoromethyl)phenyl]phosphine, 97%	330
C ₂₄ H ₁₆ N ₂	4,7-Diphenyl-1,10-phenanthroline, 99% (Bathophenanthroline)	198
C ₂₄ H ₁₈ F ₁₂ N ₁₂ P ₂ Ru	Tris(2,2'-bipyrazine)ruthenium(II) hexafluorophosphate, 95%	401
C ₂₄ H ₁₈ BN ₃ Tl	Thallium hydrotris[3-(2-pyridyl)pyrazol-1-yl]borate, min. 98%	432
C ₂₄ H ₂₀ AsCl	Tetraphenylarsonium chloride monohydrate, 99%	10
C ₂₄ H ₂₀ BF ₄ NaO ₂	Sodium tetrakis(4-fluorophenyl)borate dihydrate, 97%	421
C ₂₄ H ₂₀ Bli	Lithium tetraphenylborate tris(1,2-dimethoxyethane)adduct, 98%	118
C ₂₄ H ₂₆ BNa	Sodium tetraphenylborate, 99.5+% (ACS)	421

Formula	Description	Page
	Sodium tetraphenylborate, tech. gr. (min. 95%)	421
C ₂₄ H ₂₆ BrP	Tetraphenylphosphonium bromide, 99%	325
C ₂₄ H ₂₆ Br ₂ O ₄	(R)-(+)-6,6'-Dibromo-2,2'-bis(methoxymethoxy)-1,1'-binaphthyl, min. 98%	217
	(S)-(-)-6,6'-Dibromo-2,2'-bis(methoxymethoxy)-1,1'-binaphthyl, min. 98%	217
	(R)-(+)-6,6'-Dibromo-2,2'-bis(methoxymethoxy)-1,1'-binaphthalene, min. 98% (99% ee)	217
	(S)-(-)-6,6'-Dibromo-2,2'-bis(methoxymethoxy)-1,1'-binaphthalene, min. 98% (99% ee)	217
C ₂₄ H ₂₆ Cl ₂ N ₂ Pd ₂	Chloro(2'-amino-1,1'-biphenyl-2-yl)palladium(II) dimer, min. 98%	229
C ₂₄ H ₂₆ NO ₃ P	(S)-(+)-(3,5-Dioxa-4-phospha-cyclohepta[2,1-a:3,4-a']dinaphthalen-4-yl)morpholine, min. 97% (S)-MorPhos	302
C ₂₄ H ₂₆ Pb	Tetraphenyllead, min. 97%	115
C ₂₄ H ₂₆ Sn	Tetraphenyltin, min. 95%	436
C ₂₄ H ₂₄ NP ₂	N,N-Bis(diphenylphosphino)amine, min. 98%	266
C ₂₄ H ₂₂ NO ₂ P	(S)-(+)-(2,6-Dimethyl-3,5-dioxa-4-phospha-cyclohepta[2,1-a:3,4-a']dinaphthalen-4-yl)dimethylamine, min. 98%	298
	(S)-(+)-(3,5-Dioxa-4-phospha-cyclohepta[2,1-a:3,4-a']dinaphthalen-4-yl)diethylamine, min. 97%	302
C ₂₄ H ₂₂ NP	2-[(11bS)-3,5-Dihydro-4H-dinaphtho[2,1-c:1',2'-e]phosphepin-4-yl]ethylamine, min. 97%	297
C ₂₄ H ₂₂ O ₃ PRh	Carbonyl(acetylacetonato)(triphenylphosphine)rhodium(I), 99%	356
C ₂₄ H ₂₂ O ₄	(R)-(+)-2,2'-Bis(methoxymethoxy)-1,1'-binaphthyl, 98%	215
	(S)-(-)-2,2'-Bis(methoxymethoxy)-1,1'-binaphthyl, 98%	215
C ₂₄ H ₂₄ FeNP	(R)-1-(S)-2-Diphenylphosphino)ferrocenylethylamine, min. 97%	103
	(S)-1-(R)-2-Diphenylphosphino)ferrocenylethylamine, min. 97%	103
C ₂₄ H ₂₄ I ₂ N ₄	11,12-Bis[3-methylimidazolium]-9,10-dihydro-9,10-ethanoanthracene bis(iodide), min. 95%	186
C ₂₄ H ₂₄ NOP	(R)-(+)-2-[2-(Diphenylphosphino)phenyl]-4-(1-methylthyl)-4,5-dihydrooxazole, 98% (R)-iPr-PHOX	308
	(S)-(-)-2-[2-(Diphenylphosphino)phenyl]-4-(1-methylthyl)-4,5-dihydrooxazole, 98% (S)-iPr-PHOX	308
C ₂₄ H ₂₅ Na ₂ O ₆ PS ₂	Bis(4,6-dimethyl-3-sulfonatophenyl)(2,4-dimethylphenyl)phosphine, disodium salt hydrate, min. 95% TXPDS	266
C ₂₄ H ₂₆ NP	9-[2-(Di-i-propylphosphino)phenyl]-9H-carbazole, min. 97% i-Pr PhenCar-Phos	310
C ₂₄ H ₂₆ N ₂ O ₂	(1'R,2'R,3aS,3'aS,8aR,8'aR)-(+)-3,3',3a,3'a,8,8',8a,8'a-Octahydrodispiro[2H-indeno[1,2-d]oxazole-2,1'-cyclohexane-2',2'-[2H]indeno[1,2-d]oxazole} WOLF BISOXAZOLINE	204
C ₂₄ H ₂₇ ClN ₂ O ₂	Chloro[(1R,2R)-1,2-diphenyl-1-[(3-(n6-phenyl)propyl)amino]-2-(methylsulfonylamido)]ruthenium(II) RuCl(R,R)-teth-MsDpen)	378
	Chloro[(1S,2S)-1,2-diphenyl-1-[(3-(n6-phenyl)propyl)amino]-2-(methylsulfonylamido)]ruthenium(II) RuCl(S,S)-teth-MsDpen)	378
C ₂₄ H ₂₇ N ₂ P ₂	1-[(2S)-1-(Di-o-tolylphosphinoxy)propan-2-yl]-3-phenylurea, min. 97%	312
C ₂₄ H ₂₄ Na ₃ O ₉ PS ₃	Tris(4,6-dimethyl-3-sulfonatophenyl)phosphine trisodium salt hydrate, min. 97% TXPTS	331
C ₂₄ H ₂₇ O ₆ P	Tris(2,6-dimethoxyphenyl)phosphine, min. 97%	331
C ₂₄ H ₂₇ P	Tris(3,5-dimethylphenyl)phosphine, 98%	331
	Tris(2,4-dimethylphenyl)phosphine, 98%	331
C ₂₀ H ₂₀ ClIrN ₂	Chloro(1,5-cyclooctadiene)(1,10-phenanthroline)iridium(III) THF adduct, min. 98%	87

Formula Index

Formula	Description	Page
C ₂₄ H ₂₈ Br ₂ ClN ₂ Si	(1R,2R)-(-)-[N,N'-Bis(4-bromobenzyl)-1,2-cyclohexanediamino][(2E)-2-buten-1-yl]chlorosilane, min. 98%	405
C ₂₄ H ₂₈ (+)-[N,N'-Bis(4-bromobenzyl)-1,2-cyclohexanediamino][(2E)-2-buten-1-yl]chlorosilane, min. 98%	405	
C ₂₄ H ₃₀ Cl-N ₂ O ₂ RuS	Chloro(mesitylene)[(1R,2R)-(-)-2-amino-1,2-diphenylethyl(methylsulfonamidido)]ruthenium(II) RuCl(mesitylene)[(R,R)-MsDpen]	378
C ₂₄ H ₂₈ ClN ₂ Pd	Allylchloro[1,3-bis(2,4,6-trimethylphenyl)imidazol-2-ylidene]palladium(II), 98%	226
C ₂₄ H ₃₀ Cr ₂ O ₄	Pentamethylcyclopentadienylchromium dicarbonyl dimer, 99%	46
C ₂₄ H ₃₀ Fe ₂ O ₄	Pentamethylcyclopentadienyliron dicarbonyl dimer, min. 98%	110
C ₂₄ H ₃₀ Mo ₂ O ₄	Pentamethylcyclopentadienylmolybdenum dicarbonyl dimer, 99%	138
C ₂₄ H ₃₁ P	2-(Dicyclohexylphosphino)-1,1'-biphenyl, 98% CyJohnPhos	292
C ₂₄ H ₃₂ F ₁₂ FeN ₂ Sb ₂	(2S,2'S)-(-)-[N,N'-Bis(2-pyridylmethyl)-2,2'-bipyrolidinedibis(acetonitrile)]iron(II) hexafluoroantimonate Fe(S,R-PDP) White-Chen Catalyst	99
C ₂₄ H ₃₀ O ₈	Dibenzo-24-crown-8, 98%	216
C ₂₄ H ₃₂ P ₂	(1R,1'R,2S,2'S)-(+)-2,2'-Di-t-butyl-2,3,2',3'-tetrahydro-1,1'-bi-1H-isophosphindole, min. 98% (R,R,S,S)-DUANPHOS	291
C ₂₄ H ₃₃ Ce	Tris(i-propylcyclopentadienyl)cerium(III) (99.9%-Ce) (REO)	42
C ₂₄ H ₃₃ ClN ₂	1-(2,6-Di-i-propylphenyl)-3-(2,4,6-trimethylphenyl)-4,5-dihydroimidazolium chloride, min. 97%	199
C ₂₄ H ₃₃ Dy	Tris(i-propylcyclopentadienyl)dysprosium(III) (99.9%-Dy) (REO)	60
C ₂₄ H ₃₃ Er	Tris(i-propylcyclopentadienyl)erbium(III) (99.9%-Er) (REO)	62
C ₂₄ H ₃₃ La	Tris(i-propylcyclopentadienyl)lanthanum (99.9%-La) (REO)	113
C ₂₄ H ₃₃ Nd	Tris(i-propylcyclopentadienyl)neodymium (99.9%-Nd) (REO)	170
C ₂₄ H ₃₃ P	Di-t-butyl(2,2-diphenyl-1-methyl-1-cyclopropyl)phosphine cBRDP	287
C ₂₄ H ₃₃ Pr	Tris(i-propylcyclopentadienyl)praseodymium (99.9%-Pr) (REO)	346
C ₂₄ H ₃₃ Tb	Tris(i-propylcyclopentadienyl)terbium (99.9%-Tb) (REO)	431
C ₂₄ H ₃₃ Y	Tris(n-propylcyclopentadienyl)yttrium (99.9%-Y) (REO)	449
C ₂₄ H ₃₄ O ₂	racemic-5,5',6,6'-Tetramethyl-3,3'-di-t-butyl-1,1'-biphenyl-2,2'-diol, 99% rac-BIPHEN H ₂	221
C ₂₄ H ₃₄ O ₂	(R)-(+)-5,5',6,6'-Tetramethyl-3,3'-di-t-butyl-1,1'-biphenyl-2,2'-diol, 99% (R)-BIPHEN H ₂	221
C ₂₄ H ₃₄ O ₂	(S)-(-)-5,5',6,6'-Tetramethyl-3,3'-di-t-butyl-1,1'-biphenyl-2,2'-diol, 99% (S)-BIPHEN H ₂	221
C ₂₄ H ₃₅ N ₂ P	1-(2,4,6-Trimethylphenyl)-2-(dicyclohexylphosphino)imidazole, min. 95% [cataCXium® PICy]	328
C ₂₄ H ₃₆ F ₆ O ₃ P ₂ RhSb	(-)-2,3-Bis[(2R,5R)-2,5-dimethylphospholanyl]maleic anhydride(1,5-cyclooctadiene)rhodium(I) hexafluoroantimonate, min. 97% [catASium® M(R)RhSbF ₆]	352
C ₂₄ H ₃₆ FeP ₂	(-)-1,1'-Bis((2S,4S)-2,4-diethylphosphonato)ferrocene, min. 95% (S,S)-Et-FerroTANE	95
C ₂₄ H ₃₅ BF ₄ N ₂	1-(2,4,6-Trimethylphenyl)-3-(cyclodecyl)imidazolium tetrafluoroborate, min. 97%	210
C ₂₄ H ₃₇ ClNPPd	Chloro(tri-t-butylphosphino)(2'-amino-1,1'-biphenyl-2-yl)palladium(II), min. 98%	235

Formula	Description	Page
C ₂₄ H ₃₇ N ₂ Cl	1-(2,4,6-Trimethylphenyl)-3-(cyclodecyl)imidazolium chloride, min. 97%	210
C ₂₄ H ₃₆ Ba	Bis(n-propyltetramethylcyclopentadienyl)barium, min. 98%	12
C ₂₄ H ₃₉ P	Butyl-di-1-adamantylphosphine, min. 95% [cataCXium® A]	282
C ₂₄ H ₄₀ BF ₄ O ₂ P	[2,6-Di-i-propylphenyl]dicyclohexylphosphonium tetrafluoroborate, 98% Gorlos-PhosHBF ₄	309
C ₂₄ H ₄₀ IP	n-Butyl-di-(1-adamantyl)phosphonium iodide, min. 95% [cataCXium® AH]	282
C ₂₄ H ₄₄ P ₂	1,3-Bis(di-t-butylphosphinomethyl)benzene, 99%	257
C ₂₄ H ₄₄ P ₂	α, α'-Bis(di-t-butylphosphino)-o-xylene, min. 97%	258
C ₂₄ H ₄₄ Sn	Tetracyclohexyltin, 99%	435
C ₂₄ H ₄₅ BiO ₆	Bismuth(III) 2-ethylhexanoate, 72% in mineral spirits (~28% Bi)	23
C ₂₄ H ₄₅ BiO ₆	Bismuth(III) 2-ethylhexanoate, 70-75% in xylenes (~24% Bi) (99.99+%-Bi) PURATREM	23
C ₂₄ H ₄₅ BiO ₆	Bismuth(III) 2-ethylhexanoate, ~30% wt/wt Bi in 2-ethylhexanoic acid (99.98%-Bi)	23
C ₂₄ H ₄₅ CeO ₆	Cerium(III) 2-ethylhexanoate, 49% in 2-ethylhexanoic acid (12% Ce)	41
C ₂₄ H ₄₅ CrO ₆	Chromium(III) 2-ethylhexanoate, 70% in mineral spirits (8-10% Cr)	45
C ₂₄ H ₄₅ EuO ₆	Europium(III) 2-ethylhexanoate (99.9%-Eu) (REO)	62
C ₂₄ H ₄₅ FeO ₆	Iron 2-ethylhexanoate, 6% (Fe) in mineral spirits (99.998+%-Fe) PURATREM	107
C ₂₄ H ₄₅ GdO ₆	Gadolinium(III) 2-ethylhexanoate (~25% in toluene)	67
C ₂₄ H ₄₅ N ₆ O ₄ P	1-Butyl-3-methylimidazolium phosphate, 99% [BMIM] ₃ [PO ₄]	81
C ₂₄ H ₄₅ NdO ₆	Neodymium(III) 2-ethylhexanoate (10-15% Nd)	169
C ₂₄ H ₄₅ O ₆ Y	Yttrium(III) 2-ethylhexanoate (15-17% Y), superconductor grade (99.9%-Y) (REO)	449
C ₂₄ H ₄₆ B ₂ F ₈ P ₂	1,4-Bis(dicyclopropylphosphonium)butane bis(tetrafluoroborate), min. 97%	259
C ₂₄ H ₅₁ LuN ₆	Tris(N,N'-di-i-propylacetamidinato)lutetium(III), 99%	120
C ₂₄ H ₅₁ N	Didodecylamine, min. 97%	167
C ₂₄ H ₅₁ N ₆ Yb	Tris(N,N'-di-i-propylacetamidinato)ytterbium(III), 99%	447
C ₂₄ H ₅₁ OP	Triocetylphosphine oxide, min. 90% TOPO	329
C ₂₄ H ₅₁ OP	Triocetylphosphine oxide, 99% TOPO	329
C ₂₄ H ₅₁ P	Tri-n-octylphosphine, min. 97% TOP	329
C ₂₄ H ₅₄ Br ₂ P ₂ Pd ₂	Di-μ-bromobis(tri-t-butylphosphino)dipalladium(I), 98%	236
C ₂₄ H ₅₄ I ₂ P ₂ Pd ₂	Di-μ-iodobis(tri-t-butylphosphino)dipalladium(I), 98%	239
C ₂₄ H ₅₄ OSn ₂	Bis(tri-n-butyltin)oxide, 96%	434
C ₂₄ H ₅₄ O ₂ SSn ₂	Bis(tri-n-butyltin)sulfate, min. 97%	434
C ₂₄ H ₅₄ P ₂ Pd	Bis(tri-t-butylphosphino)palladium(0), 98%	228
C ₂₄ H ₅₄ P ₂ Pt	Bis(tri-t-butylphosphino)platinum(0), 98%	337
C ₂₄ H ₅₄ SSn ₂	Bis(tri-n-butyltin)sulfide, 97%	434
C ₂₄ H ₅₆ Sn ₂	Hexa-n-butyliditin, min. 95%	435
C ₂₄ H ₅₆ Al ₂ MgO ₆	Magnesium aluminum i-propoxide (99.99%-Mg) PURATREM	122
C ₂₄ H ₇₂ Co ₂ N ₄ Si ₈	Bis[μ-[di(trimethylsilyl)amide]bis[di(trimethylsilyl)amide]]dicobalt(II), 98%	47
C ₂₅ H ₁₈ N ₃ O ₂	(-)-2,6-Bis[(3aS,8aR)-3a,8a-dihydro-8H-indeno[1,2-d]oxazolin-2-yl]pyridine, min. 97% Indenyl-PYBOX	182
C ₂₅ H ₂₂ Au ₂ Cl ₂ P ₂	[μ-Bis(diphenylphosphino) methane]dichlorogold(I), 99%	72
C ₂₅ H ₂₂ CIP	Benzyltriphenylphosphonium chloride, 99%	252
C ₂₅ H ₂₂ NO ₂ P	(S)-(+)-(3,5-Dioxo-4-phospho-cyclohepta[2,1-a:3,4-a']dinaphthalen-4-yl)piperidine, min. 97% (S)-PipPhos	302
C ₂₅ H ₂₂ P ₂	Bis(diphenylphosphino)methane, 97%	269
C ₂₅ H ₂₃ N ₃ O ₂	2,6-Bis[(4R)-benzyl-2-oxazolin-2-yl]pyridine, min. 98%	180
C ₂₅ H ₂₃ N ₃ O ₂	2,6-Bis[(4S)-benzyl-2-oxazolin-2-yl]pyridine, min. 98%	180
C ₂₅ H ₂₃ O ₃ P	4-(Anthracen-9-yl)-3-(t-butyl)-2,3-dihydrobenzo[d][1,3]oxaphosphole, 98+% rac-AntPhos	250

Formula Index

Formula	Description	Page	Formula	Description	Page
	(R)-4-(Anthracen-9-yl)-3-(t-butyl-2,3-dihydrobenzo[d][1,3]oxaphosphole,98+% (>99% ee) [(R)-AntPhos].....	251	C ₂₆ H ₂₄ Cl ₂ NiP ₂	1,2-Bis(diphenylphosphino)ethane nickel(II) chloride, 99%.....	172
	(S)-4-(Anthracen-9-yl)-3-(t-butyl-2,3-dihydrobenzo[d][1,3]oxaphosphole,99+% (>99% ee) [(S)-AntPhos].....	251	C ₂₆ H ₂₄ Cl ₂ P ₂ Pd	Dichloro(1,2-bis(diphenylphosphino)ethane) palladium(II), 98%.....	237
C ₂₅ H ₂₅ P	(11aR)-(+)-5,6,10,11,12,13-Hexahydro-5-phenyl-4H-diindeno[7,1-cd:1',7'-ef]phosphocin, min. 97% (R)-SITCP.....	313	C ₂₆ H ₂₄ CoP ₂	Cobalt-dppe heterogeneous water oxidation catalyst (-17% Co).....	50
	(11aS)-(+)-5,6,10,11,12,13-Hexahydro-5-phenyl-4H-diindeno[7,1-cd:1',7'-ef]phosphocin, min. 97% (S)-SITCP.....	313	C ₂₆ H ₂₄ NP	2-Diphenylphosphino-2'-(N,N-dimethylamino)-1,1'-biphenyl, 98% PhDavePhos.....	304
C ₂₅ H ₂₆ ClIrN ₂ O ₃	Chloro(pentamethylcyclopentadienyl){5-nitro-2-[1-(4-methoxyphenyl)imino-kN]ethyl}phenyl-kC}iridium(III), 99% Iridicycle-NO2....	88		(1R,2R)-2-(Diphenylphosphino)-1,2-diphenylethylamine, min. 97%.....	304
C ₂₅ H ₂₆ ClN ₂ O ₃	Chloro-N-[(1R,2R)-2-[(S)-2-[[1,2,3,4,5,6-η)-4-methylphenyl]methoxy]ethyl]amino-1,2-diphenylethylmethanesulfonamidato} ruthenium(II) Ru-(R)-Ms-DENEB.....	379	C ₂₆ H ₂₄ OP ₂	1,2-Bis(diphenylphosphino)ethane mono-oxide, min. 97%.....	268
RuS	Chloro-N-[(1S,2S)-2-[(R)-2-[[1,2,3,4,5,6-η)-4-methylphenyl]methoxy]ethyl]amino-1,2-diphenylethylmethanesulfonamidato} ruthenium(II) Ru-(S)-Ms-DENEB.....	379	C ₂₆ H ₂₄ P ₂	1,2-Bis(diphenylphosphino)ethane, 99% DIPHOS.....	268
C ₂₅ H ₃₁ ClN ₂ O ₂	Chloro(p-cymene)((1R,2R)-(-)-2-amino-1,2-diphenylethyl(methylsulfonfylamido)} ruthenium(II) RuCl(p-cymene).....	376	C ₂₆ H ₂₅ BF ₄ NP	(1R,2R)-2-(Diphenylphosphino)-1,2-diphenylethylammonium tetrafluoroborate, min. 97%.....	304
RuS	Chloro(p-cymene)((1R,2R)-(-)-2-amino-1,2-diphenylethyl(methylsulfonfylamido)} ruthenium(II) RuCl(p-cymene).....	376	C ₂₆ H ₂₆ N ₂ O ₆ Pd ₂	(2'-Amino-1,1'-biphenyl-2-yl)methanesulfonatotetrapalladium(II) dimer, min. 98%.....	226
	Chloro(p-cymene)((1S,2S)-(-)-2-amino-1,2-diphenylethyl(methylsulfonfylamido)} ruthenium(II) RuCl(p-cymene).....	376	C ₂₆ H ₂₅ ClIrN ₂ O	Chloro(pentamethylcyclopentadienyl){5-cyano-2-[1-(4-methoxyphenyl)imino-kN]ethyl}phenyl-kC}iridium(III), 99% Iridicycle-CN.....	87
C ₂₅ H ₃₂ CIPRh	Chloronorbornadienetriphenylphosphinerhodium(I) (~5% Rh) polymer-bound FibreCat™	357	C ₂₆ H ₃₀ Cl ₂ Pd ₂	Chloro(1-t-butylindenylo)palladium(II) dimer, 98%.....	230
C ₂₅ H ₃₃ P	2-Dicyclohexylphosphino-2'-methyl-1,1'-biphenyl, min. 98% MePhos.....	294	C ₂₆ H ₃₁ ClIrNO ₂	Chloro(pentamethylcyclopentadienyl){5-methoxy-2-[[4-methoxyphenyl]imino-kN]ethyl}phenyl-kC}iridium(III), 99% Iridicycle-MeO.....	88
C ₂₅ H ₃₅ P	Dicyclohexyl(2,2-diphenyl-1-methylvinyl)phosphine Cy-vBRIDP.....	291	C ₂₆ H ₃₁ IrO ₂	Tris(norbornadiene)(acetylacetonato) iridium(III), 98% (99.9%-Ir).....	93
C ₂₅ H ₃₆ F ₃ O ₆ P ₂	(-)-2,3-Bis[(2R,5R)-2,5-dimethylphospholanyl]maleic anhydride(1,5-cyclooctadiene)rhodium(I) trifluoromethanesulfonate, min. 97% [catASium® M(R)RhOTf].....	352	C ₂₆ H ₃₂ NP	N-Phenyl-2-(dicyclohexylphosphino)indol, min. 95% [cataCXium® PlnCyl].....	318
C ₂₅ H ₃₇ NPRh	3-Di-i-propylphosphoranylidene-2-(N,N-dimethylamino)-1H-indene(1,5-cyclooctadiene)rhodium(I), min. 95%.....	358	C ₂₆ H ₃₂ P	2-(Dicyclohexylphosphino)-2-phenyl-1H-indole, min. 98% NPCy Phendole-Phos.....	295
C ₂₅ H ₃₈ BF ₄ N	2-[2,6-Bis(1-methylethyl)phenyl]-3,3,6,8-tetramethyl-2-azoniaspiro[4.5]dec-1,7-diene tetrafluoroborate Trivertal-CAAC.....	186	C ₂₆ H ₃₃ N ₂ P	2-(t-Butylphenylphosphino)-2',6'-dimethylamino-1,1'-biphenyl, 98% (t-Bu)PhCPhos.....	282
C ₂₅ H ₃₈ F ₆ IrNP ₂	3-Di-i-propylphosphino-2-(N,N-dimethylamino)-1H-indene(1,5-cyclooctadiene)iridium(I) hexafluorophosphate, min. 98%.....	91	C ₂₆ H ₃₄ NaO ₆ PS	2'-Dicyclohexylphosphino-2,6-dimethoxy-3-sulfonato-1,1'-biphenyl hydrate sodium salt (water soluble SPhos), min. 98%.....	292
C ₂₅ H ₃₈ F ₆ NP ₂ Rh	3-Di-i-propylphosphino-2-(N,N-dimethylamino)-1H-indene(1,5-cyclooctadiene)rhodium(I) hexafluorophosphate, min. 98%.....	358	C ₂₆ H ₃₅ AuClO ₂ P	Chloro(2-dicyclohexylphosphino-2',6'-dimethoxy-1,1'-biphenyl)gold(II), 98%.....	74
C ₂₅ H ₃₈ BF ₄ NO ₂	(-)-2,3-Bis[(2R,5R)-2,5-dimethylphospholanyl]-1-methyl-1H-pyrrole-2,5-dione(1,5-cyclooctadiene)rhodium(I) tetrafluoroborate, min. 97% [catASium® MN(R)Rh]... (+)-2,3-Bis[(2S,5S)-2,5-dimethylphospholanyl]-1-methyl-1H-pyrrole-2,5-dione(1,5-cyclooctadiene)rhodium(I) tetrafluoroborate, min. 98% [catASium® MN(S)Rh]... ..	352	C ₂₆ H ₃₆ O ₂ P	2-Dicyclohexylphosphino-2',6'-dimethoxy-1,1'-biphenyl, min. 98% SPhos.....	292
C ₂₅ H ₄₀ NO ₃ PPdS	Methanesulfonato[di-t-butyl(n-butyl)phosphine](2'-amino-1,1'-biphenyl-2-yl) palladium(II) dichloromethane adduct, min. 98% [P(t-Bu) ₂ (n-Bu) Palladacycle Gen. 3].....	241	C ₂₆ H ₃₆ AuClNP	Chloro[2-(dicyclohexylphosphino)-2'-(N,N-dimethylamino)-1,1'-biphenyl]gold(II), 98%.....	74
	Methanesulfonato(tri-t-butylphosphino) (2'-amino-1,1'-biphenyl-2-yl)palladium(II), 98% [P(t-Bu) ₃ Palladacycle Gen. 3].....	246	C ₂₆ H ₃₆ FeOP ₂	(R,S,p), R(SPO)-1-Phenylphosphino-2-[1-(di-t-butylphosphino)ethyl]ferrocene, min. 97% JoSPHos.....	110
C ₂₅ H ₄₆ P ₂	Bis(dicyclohexylphosphino)methane, min. 97%.....	258	C ₂₆ H ₃₆ NOP	[2-Dicyclohexylphosphino-3-methoxy-N-methyl-N-phenylbenzenamine, 98% Zheda-Phos.....	294
C ₂₆ H ₄ F ₂₀ P ₂	1,2-Bis(dipentafluorophenylphosphino)ethane, 99%.....	266	C ₂₆ H ₃₆ NP	2-(Dicyclohexylphosphino)-2'-(N,N-dimethylamino)-1,1'-biphenyl, 98% DavePhos.....	293
C ₂₆ H ₂₀ P ₂	Bis(diphenylphosphino)acetylene, 97%.....	266		2-Dicyclohexylphosphino-4'-(N,N-dimethylamino)-1,1'-biphenyl, 98%.....	293
C ₂₆ H ₂₂ P ₂	cis-1,2-Bis(diphenylphosphino)ethylene, min. 98%.....	268	C ₂₆ H ₄₀ BF ₄ P ₂ Rh	(-)-1,2-Bis[(2R,5R)-2,5-dimethylphospholano]benzene(1,5-cyclooctadiene)rhodium(I) tetrafluoroborate, 98+% (R,R)-Me-DUPHOS-Rh.....	350
C ₂₆ H ₂₄ Cl ₂ CoP ₂	1,2-Bis(diphenylphosphino)ethanedichlorocobalt(II), min. 97%.....	47		(+)-1,2-Bis[(2S,5S)-2,5-dimethylphospholano]benzene(1,5-cyclooctadiene)rhodium(I) tetrafluoroborate, 98+% (S,S)-Me-DUPHOS-Rh.....	350
C ₂₆ H ₂₄ Cl ₂ FeP ₂	Dichloro[1,2-bis(diphenylphosphino)ethane] iron(II), 98%.....	100	C ₂₆ H ₄₀ FeP ₂	1,1'-Bis[(2R,5R)-2,5-diethylphospholano]ferrocene, min. 97%.....	95
				1,1'-Bis[(2S,5S)-2,5-diethylphospholano]ferrocene, min. 97%.....	95
			C ₂₆ H ₄₀ O ₂ P ₂	(R)-(+)-2,2'-Bis(di-i-propylphosphino)-6,6'-dimethoxy-1,1'-biphenyl, min. 97%.....	273
				(S)-(-)-2,2'-Bis(di-i-propylphosphino)-6,6'-dimethoxy-1,1'-biphenyl, min. 97%.....	273
			C ₂₆ H ₄₁ NP ₂	Bis[2-(di-i-propylphosphino)-4-methylphenyl]amine, min. 98%.....	273

Formula Index

Formula	Description	Page
$C_{26}H_{42}BF_4N_2O_2$ P_2Rh	(-)-4,5-Bis[(2R,5R)-2,5-dimethylphospholanyl](1,2-dimethyl-1,2-dihydroimidazole-3,6-dione)(1,5-cyclooctadiene)rhodium(I) tetrafluoroborate, min. 95% [catASium® MNN(R)R].....	352
$C_{26}H_{42}NO_3PPdS$	Methanesulfonato(di-t-butylneopentylphosphine)(2'-amino-1,1'-biphenyl-2-yl)palladium(II), min. 98% [DTBNpP Palladacycle Gen. 3].....	242
$C_{26}H_{44}Cl_2FeP_2$ Pd	Methanesulfonato(tri-t-butylphosphino)(2'-methylamino-1,1'-biphenyl-2-yl)palladium(II), 98% [P(t-Bu), Palladacycle Gen. 4] ...	246
$C_{26}H_{44}Cl_2FeP_2$ Pd	Dichloro[1,1'-bis(di-t-butylphosphino)ferrocene]palladium(II), 99%.....	236
$C_{26}H_{44}FeP_2$	1,1'-Bis(di-t-butylphosphino)ferrocene, min. 98% DTBPF.....	95
$C_{26}H_{44}P_2$	(+)-1,2-Bis[(2R,5R)-2,5-di-i-propylphospholano]benzene, 98+% (R,R)-i-Pr-DUPHOS.....	273
$C_{26}H_{44}P_2$	(-)-1,2-Bis[(2S,5S)-2,5-di-i-propylphospholano]benzene, 98+% (S,S)-i-Pr-DUPHOS.....	273
$C_{26}H_{46}BF_4P_2Rh$	1,2-Bis[(2R,5R)-2,5-diethylphospholano]ethane(cyclooctadiene)rhodium(I) tetrafluoroborate.....	350
$C_{26}H_{46}BF_4P_2Rh$	1,2-Bis[(2S,5S)-2,5-diethylphospholano]ethane(cyclooctadiene)rhodium(I) tetrafluoroborate.....	350
$C_{26}H_{48}N_4O_8$	1,4,8,11-Tetraazacyclotetradecane-N,N',N'',N'''-tetraacetic acid, tetraethyl ester, min. 98%.....	208
$C_{26}H_{48}P_2$	1,2-Bis(dicyclohexylphosphino)ethane, min. 98%.....	258
$C_{26}H_{50}B_2F_8P_2$	1,2-Bis(dicyclohexylphosphonium)ethane bis(tetrafluoroborate), min. 97%.....	259
$C_{27}H_{18}O_6$	1,3,5-Tris(4-carboxyphenyl)benzene, min. 98% BTB.....	221
$C_{27}H_{26}Cl_2FeP_2$	Dichloro[1,3-bis(diphenylphosphino)propane]iron(II), 98%.....	100
$C_{27}H_{26}Cl_2NiP_2$	1,3-Bis(diphenylphosphino)propane nickel(II) chloride, 99%.....	172
$C_{27}H_{26}Cl_2P_2Pd$	Dichloro(1,3-bis(diphenylphosphino)propane)palladium(II), 98%.....	238
$C_{27}H_{26}N_2O_2$	(4S,4'S)-2,2'-(1-Phenylpropane-2,2-diyl)bis(4-phenyl-4,5-dihydrooxazole) (S)-BnPh-SaBOX.....	205
$C_{27}H_{26}OP_2$	1,3-Bis(diphenylphosphino)propane monooxide, min. 97%.....	270
$C_{27}H_{26}P_2$	R-(+)-1,2-Bis(diphenylphosphino)propane, 99% (R)-PROPHOS.....	270
$C_{27}H_{26}P_2$	1,3-Bis(diphenylphosphino)propane, 98% DPPP.....	270
$C_{27}H_{28}F_3N_2O_4PS$	N-[(11bS)-Dinaphtho[2,1-d:1',2']-[1,3,2]dioxaphospepin-4-yl]-1,1,1-trifluoromethanesulfonamide triethylamine adduct, min. 97% METAMORPhos.....	301
$C_{27}H_{33}O_3P$	Tris(4-methoxy-3,5-dimethylphenyl)phosphine, min. 98%.....	332
$C_{27}H_{33}O_3P$	Tris(2,4,6-trimethoxyphenyl)phosphine, min. 97%.....	332
$C_{27}H_{33}P$	Tris(2,4,6-trimethylphenyl)phosphine, 98% ...	332
$C_{27}H_{34}NOP$	1-(Dicyclohexylphosphino)-2-(2-methoxyphenyl)-1H-indole, min. 98% NPCy o-Andole-Phos.....	294
$C_{27}H_{34}NP$	2-[2-(Dicyclohexylphosphino)phenyl]-1-methyl-1H-indole, min. 98% CM-Phos.....	295
$C_{27}H_{36}ClN_2$	1,3-Bis(1-adamantyl)benzimidazolium chloride, min. 97%.....	180
$C_{27}H_{36}AuClN_2$	1,3-Bis(2,6-di-isopropylphenyl)imidazol-2-ylidene-gold(I) chloride, 95%.....	72
$C_{27}H_{36}ClCuN_2$	Chloro[1,3-bis(2,6-di-i-propylphenyl)imidazol-2-ylidene]copper(II), 98%.....	56
$C_{27}H_{36}Cl_2N_2$	1,3-Bis(2,6-di-i-propylphenyl)-2-chloroimidazolium chloride, 98+%.....	183
$C_{27}H_{36}Cl_2N_2$	1,3-Bis(2,6-di-i-propylphenyl)-2-chloroimidazolium chloride/cesium fluoride admixture (1.0/6.7 molar ratio or 1/2.2 weight ratio) PhenoFluor®Mix.....	183
$C_{27}H_{36}N_2$	1,3-Bis(2,6-di-i-propylphenyl)imidazol-2-ylidene, min. 98%.....	184

Formula	Description	Page
$C_{27}H_{37}AuN_2O$	1,3-Bis(2,6-di-i-propylphenyl)imidazol-2-ylidene-gold(I) hydroxide, min. 97%	72
$C_{27}H_{37}ClN_2$	1,3-Bis(2,6-di-i-propylphenyl)imidazolium chloride, min. 97%.....	184
$C_{27}H_{37}P$	Benzyl-di-1-adamantylphosphine, min. 85% [cataCXium® ABn].....	251
$C_{27}H_{38}AuClN_2$	Chloro[1,3-bis[2,6-di-i-propylphenyl]-4,5-dihydroimidazol-2-ylidene]gold(I), 98% SiPrAuCl.....	73
$C_{27}H_{38}N_2$	1,3-Bis(2,6-di-i-propylphenyl)-4,5-dihydroimidazol-2-ylidene, min. 98%.....	183
$C_{27}H_{38}BF_4N_2$	1,3-Bis(2,6-di-i-propylphenyl)-4,5-dihydroimidazolium tetrafluoroborate, min. 95%.....	183
$C_{27}H_{38}Ce$	Tris(1,2,3,4-tetramethyl-2,4-cyclopentadienyl)cerium(III) (99.9%-Ce) (REO).....	42
$C_{27}H_{38}ClFeN$ PPd	Chloro(di-2-norborylphosphino)(2-dimethylaminomethylferrocen-1-yl)palladium(II), min. 97%.....	233
$C_{27}H_{38}ClN_2$	1,3-Bis(2,6-di-i-propylphenyl)-4,5-dihydroimidazolium chloride, min. 97%.....	183
$C_{27}H_{38}Er$	Tris(n-butylcyclopentadienyl)erbium(III) (99.9%-Er) (REO).....	61
$C_{27}H_{38}Gd$	Tris(tetramethylcyclopentadienyl)gadolinium(III), min. 98%.....	67
$C_{27}H_{38}NP_2$	4,5-Bis-(di-i-propylphosphinomethyl)acridine, 98+%.....	273
$C_{27}H_{38}Nd$	Tris(tetramethylcyclopentadienyl)neodymium (99.9%-Nd) (REO).....	170
$C_{27}H_{38}Y$	Tris(butylcyclopentadienyl)yttrium (99.9%-Y) (REO).....	448
$C_{27}H_{40}F_3O_3P_2$ RhS	(-)-1,2-Bis[(2R,5R)-2,5-dimethylphospholano]benzene(1,5-cyclooctadiene)rhodium(I) trifluoromethanesulfonate, 98+% (R,R)-Me-DUPHOS-Rh.....	351
$C_{27}H_{41}N_2OP$	(+)-1,2-Bis[(2S,5S)-2,5-dimethylphospholano]benzene(1,5-cyclooctadiene)rhodium(I) trifluoromethanesulfonate, 98+% (S,S)-Me-DUPHOS-Rh.....	351
$C_{27}H_{41}N_2OP$	2-(Dicyclohexylphosphino)-N,N-bis(1-methylethyl)-1H-indole-1-carboxamide, min. 98% Amidole-Phos.....	292
$C_{27}H_{45}FeO_6$	Tris(2,6-dimethyl-3,5-heptanedionato)iron(III), 98% Fe(dibm)3.....	111
$C_{27}H_{48}F_3O_3P_2$ RhS	1,2-Bis[(2S,5S)-2,5-diethylphospholano]ethane(cyclooctadiene)rhodium(I) trifluoromethanesulfonate.....	350
$C_{27}H_{52}B_2F_8P_2$	1,3-Bis(dicyclohexylphosphonium)propane bis(tetrafluoroborate), min. 97%.....	259
$C_{27}H_{59}O_3PS$	Tributyl(tetradecyl)phosphonium methanesulfonate, min. 98% CYPHOS® IL 203.....	83
$C_{28}H_{22}NO_2P$	(S)-(+)-(3,5-Dioxa-4-phospha-cyclohepta[2,1-a:3,4-a']dinaphthalen-4-yl)benzyl(methyl)amine, 98%.....	301
$C_{28}H_{22}NO_2P$	(S)-(+)-(3,5-Dioxa-4-phospha-cyclohepta[2,1-a:3,4-a']dinaphthalen-4-yl)[(1R)-1-phenylethyl]amine, min. 95%.....	302
$C_{28}H_{24}NOP$	2-(2-Methoxyphenyl)-1-methyl-3-diphenylphosphino)-1H-indole, min. 98% PPH ₂ -Andole-Phos.....	315
$C_{28}H_{26}NO_2P$	N,N-Bis[(1R)-(+)-phenylethyl]dibenzol[d,f][1,3,2]dioxaphospepin-6-amine.....	278
$C_{28}H_{26}NO_2P$	N,N-Bis[(1S)-(-)-phenylethyl]dibenzol[d,f][1,3,2]dioxaphospepin-6-amine.....	279
$C_{28}H_{26}Cl_2P_2Pd$	Dichloro[1,4-bis(diphenylphosphino)butane]palladium(II), 99%.....	237
$C_{28}H_{28}FeNOP$	(S,S)-[2-(4'-i-Propyloxazolin-2'-yl)ferrocenyl]diphenylphosphine, min. 97%.....	110
$C_{28}H_{28}FeNOP$	(R,R)-[2-(4'-i-Propyloxazolin-2'-yl)ferrocenyl]diphenylphosphine, min. 97%.....	110
$C_{28}H_{28}Hf$	Tetrabenzylhafnium, min. 97%.....	77
$C_{28}H_{28}N_2O_4S_2$	(1R,2R)-N,N'-Di-p-tosyl-1,2-diphenyl-1,2-ethylenediamine, min. 98%.....	199
$C_{28}H_{28}N_2O_4S_2$	(1S,2S)-N,N'-Di-p-tosyl-1,2-diphenyl-1,2-ethylenediamine, min. 98%.....	199
$C_{28}H_{28}OP_2$	[Bis(2-diphenylphosphino)ethyl]ether, min. 98%.....	268
$C_{28}H_{28}O_2P_2$	(R,R)-(-)-1,2-Bis(2-methoxyphenyl)(phenyl)phosphino]ethane, 98% (-)-DIPAMP.....	278

Formula Index

Formula	Description	Page
	(S,S)-(+)-1,2-Bis[(2-methoxyphenyl)(phenyl)phosphino]ethane, 98% (+)-DIPAMP.....	278
C ₂₈ H ₂₆ P ₂	(2S,3S)-(-)-Bis(diphenylphosphino)butane (S,S)-CHIRAPHOS.....	267
	1,4-Bis(diphenylphosphino)butane, 98% DPPB.....	267
C ₂₈ H ₂₂ Zr	Tetrabenzylzirconium, min. 95%.....	456
C ₂₈ H ₂₉ Cl ₂ PRu	Dichloro(p-cymene)triphenylphosphineruthenium(II) dichloromethane adduct, min. 98%.....	391
C ₂₈ H ₂₉ N ₂ P	2-Diphenylphosphino-2',6'-bis(dimethylamino)-1,1'-biphenyl, min. 98% PhCPhOS.....	303
C ₂₈ H ₃₀ CINP ₂	Bis[(2-diphenylphosphino)ethyl]ammonium chloride, min. 97%.....	268
C ₂₈ H ₃₀ N ₂ O ₆	(2'-Methylamino-1,1'-biphenyl-2-yl)methanesulfonatopalladium(II) dimer, min. 98%.....	247
Pd ₂ S ₂	racemic-2-Di-t-butylphosphino-1,1'-binaphthyl, 98% TrixiePhos.....	288
C ₂₈ H ₃₂ BClF ₄ N ₂ P ₂ Ru	Chlorobis[2-(diphenylphosphino)ethanamine]ruthenium(II) tetrafluoroborate, min. 97%.....	374
C ₂₈ H ₃₂ Cl ₂ N ₂ P ₂ Ru	Dichlorobis[2-(diphenylphosphino)ethylamine]ruthenium(II), min. 95% (mixture of isomers).....	382
C ₂₈ H ₃₂ FeOP ₂	(R,S(p), R(SPO)-(1-t-Butylphosphino)yl)-2-[1-(diphenylphosphino)ethyl]ferrocene, min. 97% JoSPOphos.....	100
	(S, R(p), S(SPO)-(1-t-Butylphosphino)yl)-2-[1-(diphenylphosphino)ethyl]ferrocene, min. 97% JoSPOphos.....	100
C ₂₈ H ₃₄ N ₃ OP	1-Benzyl-3-[(1S,2S)-2-(di-o-tolylphosphino-amino)cyclohexyl]urea, min. 97%.....	251
C ₂₈ H ₃₅ AuF ₆ NO ₆	Bis(trifluoromethanesulfonyl)imide(2-dicyclohexylphosphino-2',6'-dimethoxy-1,1'-biphenyl)gold(I), 98%.....	73
C ₂₈ H ₃₆ AuF ₆ N ₂ O ₄ PS ₂	[2-(Dicyclohexylphosphino)-2'-(N,N-dimethylamino)-1,1'-biphenyl]bis(trifluoromethyl)sulfonylimido]gold(I), 98%.....	74
C ₂₈ H ₃₆ K ₂ O ₂	(R)-(-)-5',6',7',7',8',8'-Octahydro-3,3'-di-t-butyl-1,1'-bi-2-naphthol, dipotassium salt.....	340
	(S)-(+)-5',5',6',6',7',7',8',8'-Octahydro-3,3'-di-t-butyl-1,1'-bi-2-naphthol, dipotassium salt.....	340
C ₂₈ H ₃₇ CINPPd	Chloro(di-2-norbornylphosphino)(2'-dimethylamino-1,1'-biphenyl-2-yl)palladium(II), 97% min.....	233
C ₂₈ H ₃₇ P	Dicyclohexyl(2,2-diphenyl-1-methylcyclopropyl)phosphine Cy-cBRIDP.....	291
C ₂₈ H ₃₈ CIN ₂ PPd	Chloro[[4-(N,N-dimethylamino)phenyl]di-t-butylphosphino)(2'-amino-1,1'-biphenyl-2-yl)palladium(II), min. 98% [Amphos Palladacycle Gen. 2].....	233
C ₂₈ H ₃₈ N ₂ O ₃	1,3-Bis(2,6-di-i-propylphenyl)imidazolium bicarbonate, min. 97% IPRH.HCO ₃	183
C ₂₈ H ₃₉ F ₆ MoN ₂ O ₆ S ₂	2,6-Diisopropylphenylimido neophylidene-molybdenum(VI) bis(trifluoromethanesulfonate)dimethoxyethane adduct.....	137
C ₂₈ H ₄₀ AgF ₂ N ₂	[1,3-Bis[2,6-bis(i-propyl)phenyl]-2-imidazolidinylidene]difluoromethylsil(IV).....	413
C ₂₈ H ₄₀ CINOP ₂ Ru	Chlorocarbonylhydrido[4,5-bis-(di-i-propylphosphino)methyl] acridine] ruthenium(II), min.98% Milstein Acridine Cataly.....	376
C ₂₈ H ₄₀ NP	2-(Di-1-adamantylphosphino) dimethylaminobenzene, 97% Me-DalPhos.....	284
C ₂₈ H ₄₀ N ₂	2,3-Bis(2,6-di-i-propylphenylimino) butane, 98%.....	184
C ₂₈ H ₄₁ N ₂ P	2-Dicyclohexylphosphino-2',6'-bis(dimethylamino)-1,1'-biphenyl, min. 98% CPhOS.....	292
C ₂₈ H ₄₃ N ₂ PPd	N,N'-[Bis(2,6-dimethylphenyl)-1,3-dimethyl-1,3-propanediylidene](methyl) (triethylphosphine)palladium(II), min. 97%.....	227
C ₂₈ H ₄₄ P ₂	1,3-Bis(dicyclopentylphosphinomethyl)benzene, 99%.....	259
C ₂₈ H ₄₆ CaO ₂	Bis(pentamethylcyclopentadienyl)calcium tetrahydrofuran, 98%.....	34
C ₂₈ H ₄₆ Cl ₂ P ₂ Pd	Dichlorobis(di-t-butylphenylphosphino)palladium(II), 99%.....	236
C ₂₈ H ₄₇ Cl ₂ PRu	Dichloro(p-cymene)tricyclohexylphosphineruthenium(II), min. 97%.....	391
C ₂₈ H ₅₂ N ₂ O ₄ Pd	trans-Bis(dicyclohexylamine)bis(acetato)palladium(II) DAPCy.....	227

Formula	Description	Page
C ₃₀ H ₅₂ O ₆ Ti	Di(i-propoxide)bis(2,2,6,6-tetramethyl-3,5-heptanedionato)titanium(IV), 98%.....	440
C ₃₂ H ₅₃ NP ₂	Bis[2-(dicyclohexylphosphino)ethyl]amine, min. 97%.....	258
C ₃₂ H ₅₄ B ₂ F ₃ P ₂	1,4-Bis(dicyclohexylphosphonium)butane bis(tetrafluoroborate), min. 97%.....	258
C ₃₂ H ₆₀ BrP	Hexadecyltri-n-butylphosphonium bromide, 98+ %.....	313
C ₃₂ H ₂₆ FeNP	(R)-(-)-1-[(S)-2-(Diphenylphosphino)ferrocenyl]benzylamine, min. 98%.....	103
	(S)-(+)-1-[(R)-2-(Diphenylphosphino)ferrocenyl]benzylamine, min. 98%.....	103
C ₃₂ H ₂₉ AuBF ₄ N ₃	1,3-Bis(2,6-di-i-propylphenyl)imidazol-2-ylidene(acetonitrile)gold(II) tetrafluoroborate, 95%.....	72
C ₃₂ H ₂₉ F ₆ N ₃ OS	(2S)-(-)-2-[[[3,5-Bis(trifluoromethyl)phenyl]amino]thioxomethyl]amino-N-(diphenylmethyl)-N,3,3-trimethylbutanamide, 95%.....	188
C ₃₂ H ₂₉ NP ₂	(2S,4S)-(-)-2-(Diphenylphosphinomethyl)-4-(diphenylphosphino) pyrrolidine, min. 97% (S,S-PPM).....	306
	(2R,4R)-(+)-2-(Diphenylphosphinomethyl)-4-(diphenylphosphino) pyrrolidine, min. 97% (R,R-PPM).....	306
C ₃₂ H ₃₀ CINOP ₂ Ru	Carbonylchlorohydroido[bis(2-(diphenylphosphinoethyl)amino)ruthenium(II), min.98% Ru-MACHO™.....	368
C ₃₂ H ₃₀ P ₂	(2R,4R)-(+)-2,4-Bis(diphenylphosphino)pentane, 99% (R,R)-BDPP.....	270
	(2S,4S)-(-)-2,4-Bis(diphenylphosphino)pentane, 99% (S,S)-BDPP.....	270
	1,5-Bis(diphenylphosphino)pentane, min. 98%.....	270
C ₃₂ H ₃₁ ClIrNO	Chloro(pentamethylcyclopentadienyl) [2-1-[(4-methoxyphenyl)imino-kN]ethyl]naphthyl-kC]iridium(III), 99% Iridicyclic-Naphth.....	88
C ₃₂ H ₃₃ N ₂ P	1-(2-Di-t-butylphosphino)phenyl]-3,5-diphenyl-1H-pyrazole, 98%.....	289
C ₃₂ H ₃₄ BNOP ₂ Ru	Carbonylhydrido(tetrahydrofuran)[bis(2-diphenylphosphinoethyl) amino]ruthenium(II), min.98% Ru-MACHO™-BH.....	369
C ₃₂ H ₃₄ NO ₆ PPdS	Methanesulfonato[1,3,5,7-tetramethyl-8-phenyl-2,4,6-trioxo-8-phosphaadamantane]-(2'-amino-1,1'-biphenyl-2-yl) palladium(II) dichloromethane adduct, min. 98% [MeCgPPh Palladacycle Gen. 3].....	246
C ₃₂ H ₃₆ AuF ₆ N ₃ O ₂ S ₂	[1,3-Bis(2,6-di-i-propylphenyl)imidazol-2-ylidene]bis(trifluoromethanesulfonyl) imide]gold(II), min. 95%.....	72
C ₃₂ H ₃₈ N ₂ O ₂ S	N-[(1R,2R)-2-Amino-1,2-diphenylethyl]-2,4,6-tris(1-methylethyl)benzenesulfonamide, 98% (R,R)-TipsDPEN.....	178
	N-[(1S,2S)-2-Amino-1,2-diphenylethyl]-2,4,6-tris(1-methylethyl)benzenesulfonamide, 98% (S,S)-TipsDPEN.....	178
C ₃₂ H ₄₀ BF ₄ P	Dicyclohexyl(9-butylfluoren-9-yl)phosphonium tetrafluoroborate, min. 95% [cataCXium® FBU].....	291
C ₃₂ H ₄₁ N ₂ O ₃ PdS	Methanesulfonato[[4-(N,N-dimethylamino)phenyl]di-t-butylphosphino)(2'-amino-1,1'-biphenyl-2-yl)palladium(II), min. 98% [Amphos Palladacycle Gen. 3].....	245
C ₃₂ H ₄₅ P	2-Di-t-butylphosphino-2',4',6'-tri-i-propyl-1,1'-biphenyl, min. 98% t-BuXPhos.....	290
C ₃₂ H ₅₄ CINOP ₂ Ru	Carbonylchlorohydroido[bis(2-di-cyclohexylphosphinoethyl)amine]ruthenium(II), min. 97%.....	368
C ₃₀ CH ₄₅ P	Tris(1-adamantyl)phosphine, 97%.....	330
C ₃₀ H ₂₀ Na ₄ O ₁₂ P ₄ S ₄	1,2-Bis(di-4-sulfonatophenylphosphino)benzene tetrasodium salt DMSO adduct.....	274
C ₃₀ H ₂₀ O ₈	1,1,2,2-Tetra(4-carboxyphenyl)ethylene, 99% H ₂ TCPE.....	220
C ₃₀ H ₂₁ P	Tri(1-naphthyl)phosphine, min. 98%.....	329
C ₃₀ H ₂₂ NP	9-[2-(Diphenylphosphino)phenyl]-9H-carbazole, min. 97% Ph PhenCar-Phos.....	307
C ₃₀ H ₂₃ BrCu ₂ P	Bromo(1,10-phenanthroline)(triphenylphosphine)copper(I), min. 97%.....	55

Formula Index

Formula	Description	Page
C ₃₀ H ₂₄ Cl ₂ N ₆ Ru	Tris(2,2'-bipyridyl)ruthenium(II) chloride hexahydrate, min. 98%	401
C ₃₀ H ₂₄ Cl ₂ O ₆ P ₂ Pd	Dichloro[(R)-(+)-2,2'-bis(di-2-furanylphosphino)-6,6'-dimethoxy-1,1'-biphenyl]palladium(II)	237
C ₃₀ H ₂₄ NO ₂ P	(2R)-1-(11bS)-(Dinaphtho[2,1-d:1',2'-f][1,3,2]dioxaphosphepin-4-yl)-2-methyl-1,2,3,4-tetrahydroquinoline, 98%	300
C ₃₀ H ₂₄ (11bR)-(Dinaphtho[2,1-d:1',2'-f][1,3,2]dioxaphosphepin-4-yl)-2-methyl-1,2,3,4-tetrahydroquinoline, 98%	300	
C ₃₀ H ₂₄ O ₆ P ₂	(R)-(+)-2,2'-Bis(di-2-furanylphosphino)-6,6'-dimethoxy-1,1'-biphenyl, min. 97% .. (S)-(-)-2,2'-Bis(di-2-furanylphosphino)-6,6'-dimethoxy-1,1'-biphenyl, min. 97% ..	262
C ₃₀ H ₂₄ P ₂	1,2-Bis(diphenylphosphino)benzene, 98% ..	266
C ₃₀ H ₂₃ NP ₂	2-[Bis(diphenylphosphino)methyl]pyridine, 98% ..	269
C ₃₀ H ₂₅ N ₂ O ₄ P	1-((2R)-1-((11bR)-Dinaphtho[2,1-d:1',2'-f][1,3,2]dioxaphosphepin-4-yloxy)propan-2-yl)-3-phenylurea, min. 97% UREAPOS	300
C ₃₀ H ₂₅ N ₂ O ₄ P	1-((2S)-1-((11bR)-Dinaphtho[2,1-d:1',2'-f][1,3,2]dioxaphosphepin-4-yloxy)propan-2-yl)-3-phenylurea, min. 97% ..	300
C ₃₀ H ₂₇ ClP ₂ Ru	Chloro(cyclopentadienyl)[bis(diphenylphosphino)methane]ruthenium(II), min. 97% ..	376
C ₃₀ H ₂₆ ClF ₃ N ₂ O ₂ RuS	Chloro[(1S,2S)-(+)-2-amino-1,2-diphenylethyl](pentafluorophenylsulfonylamido)(p-cymene)ruthenium(II), min. 90% Ru-Cl[(S,S)-Fsdpen](p-cymene)	370
C ₃₀ H ₂₆ ClF ₃ N ₂ O ₂ RuS	Chloro[(1R,2R)-(-)-2-amino-1,2-diphenylethyl](pentafluorophenylsulfonylamido)(p-cymene)ruthenium(II), min. 90% Ru-Cl[(R,R)-Fsdpen](p-cymene)	370
C ₃₀ H ₂₆ FeO ₄ P ₂	1,1'-Bis[bis(5-methyl-2-furanyl) phosphino]ferrocene, 98% HiersoPHOS-3	94
C ₃₀ H ₃₀ CeF ₂₁ O ₆	Tris(6,6,7,7,8,8,8-heptafluoro-2,2-dimethyl-3,5-octanedionate)cerium(III), 99% [Ce(FOD)] ₃	42
C ₃₀ H ₃₀ ErF ₂₁ O ₆	Tris(6,6,7,7,8,8,8-heptafluoro-2,2-dimethyl-3,5-octanedionate)erbium(III) (99.9%-Er) (REO) [Er(FOD)] ₃	62
C ₃₀ H ₃₀ EuF ₂₁ O ₆	Tris(6,6,7,7,8,8,8-heptafluoro-2,2-dimethyl-3,5-octanedionate)europium(III) hydrate (99.9%-Eu) (REO) [Eu(FOD)] ₃	63
C ₃₀ H ₃₀ F ₂₁ LaO ₆	Tris(6,6,7,7,8,8,8-heptafluoro-2,2-dimethyl-3,5-octanedionate)lanthanum(III), 99% (99.9%-La) (REO) [La(FOD)] ₃	113
C ₃₀ H ₃₀ F ₂₁ NdO ₆	Tris(6,6,7,7,8,8,8-heptafluoro-2,2-dimethyl-3,5-octanedionate)neodymium(III), 99% (99.9%-Nd) (REO) [Nd(FOD)] ₃	170
C ₃₀ H ₃₀ F ₂₁ PrO ₆	Tris(6,6,7,7,8,8,8-heptafluoro-2,2-dimethyl-3,5-octanedionate)praseodymium(III), 99% (99.9%-Pr) (REO) [Pr(FOD)] ₃	346
C ₃₀ H ₃₀ F ₂₁ YbO ₆	Tris(6,6,7,7,8,8,8-heptafluoro-2,2-dimethyl-3,5-octanedionate)ytterbium(III), 99% (99.9%-Yb) (REO) [Yb(FOD)] ₃	447
C ₃₀ H ₃₀ N ₁₀	Tris[(1-benzyl-1H-1,2,3-triazol-4-yl)methyl]amine, 97% TBTA	212
C ₃₀ H ₃₀ N ₂ O ₁₀	Cucurbit[5]uril (CB[5]) ammonium sulfate hydrate, 99+%	192
C ₃₀ H ₃₁ BKN ₉	Potassium hydrotris (3-(6-methyl-3-pyridyl)-5-methylpyrazol-1-yl)borate, 97%	343
C ₃₀ H ₃₁ CIN ₂ O ₂ RuS	{N-[3-(η ⁶ -phenyl)propyl]-[(1S,2S)-1,2-diphenyl-1,4-methylbenzenesulfonylamidato(kN)-ethyl-2-amino-(kN)]}ruthenium(II) (S,S)-Teth-TsDpen RuCl WILLS CATALYST ..	397
C ₃₀ H ₃₁ CIN ₂ O ₂ RuS	{N-[3-(η ⁶ -phenyl)propyl]-[(1R,2R)-1,2-diphenyl-1,4-methylbenzenesulfonylamidato(kN)-ethyl-2-amino-(kN)]}ruthenium(II) (R,R)-Teth-TsDpen RuCl WILLS CATALYST ..	397
C ₃₀ H ₃₁ N ₂ O ₂ P	1-((1R,2S)-1-(Di-o-tolylphosphinoxy)-1-phenylpropan-2-yl)-3-phenylurea, min. 97% ..	312
C ₃₀ H ₃₃ CIN ₂ O ₂ RuS	Chloro[(1S,2S)-(+)-2-amino-1,2-diphenylethyl](4-toluenesulfonylamido)(mesitylene)ruthenium(II), min. 90% RuCl[(S,S)-Tsdpen](mesitylene)	371

Formula	Description	Page
C ₃₀ H ₃₃ N ₂ O ₄ P	Chloro[(1R,2R)-(-)-2-amino-1,2-diphenylethyl](4-toluenesulfonylamido)(mesitylene)ruthenium(II), min. 90% RuCl[(R,R)-Tsdpen](mesitylene)	371
C ₃₀ H ₃₃ NP	1-((2R)-1-((11bR)-8,9,10,11,12,13,14,15-Octahydrodinaphtho[2,1-d:1',2'-f][1,3,2]dioxaphosphepin-4-yloxy)propan-2-yl)-3-phenylurea, min. 97%	316
C ₃₀ H ₃₄ NP	9-[2-(Dicyclohexylphosphino)phenyl]-9H-carbazole, min. 98% Phen-Car-Phos	294
C ₃₀ H ₃₄ N ₂ O ₄ P ₂	(R)-(+)-2,2',6,6'-Tetramethoxy-4,4'-bis(diphenylphosphino)-3,3'-bipyridine, min. 97% CTH-(R)-P-Phos	323
C ₃₀ H ₃₄ N ₂ O ₄ P ₂	(S)-(-)-2,2',6,6'-Tetramethoxy-4,4'-bis(diphenylphosphino)-3,3'-bipyridine, min. 95% CTH-(S)-P-Phos	323
C ₃₀ H ₃₄ O ₃ P ₂	1,3,5,7-Tetramethyl-8-(2-di-o-tolylphosphino-phenyl)-2,4,6-trioxo-8-phosphaadamantane PAD-DalPhos	324
C ₃₀ H ₃₅ F ₁₂ MoN	2,6-Diisopropylphenylimidoneophylidene molybdenum(VI) bis(hexafluoro-t-butoxide) SCHROCK'S CATALYST	137
C ₃₀ H ₃₆ Cl ₂ N ₂ P ₂ Ru	Dichlorobis[3-(diphenylphosphino)propylamine]ruthenium(II), min. 97%	383
C ₃₀ H ₃₆ FeP ₂	1-Diphenylphosphino-1'-(di-t-butylphosphino)ferrocene, 97%	102
C ₃₀ H ₄₁ CIN ₂ Pd	Allylchloro[1,3-bis(2,6-di-i-propylphenyl)imidazol-2-ylidene]palladium(II), 98%	226
C ₃₀ H ₄₂ NOP	N-[2-(di-1-adamantylphosphino)phenyl]morpholine, 98% Mor-DalPhos	284
C ₃₀ H ₄₂ NaO ₃ PS	2'-Dicyclohexylphosphino-2,6-di-i-propyl-4-sulfonato-1,1'-biphenyl hydrate sodium salt (XPhos-SO ₃ Na)	293
C ₃₀ H ₄₃ CIN ₂ Pd	Allylchloro[1,3-bis(2,6-di-i-propylphenyl)-4,5-dihydroimidazol-2-ylidene]palladium(II), 97%	226
C ₃₀ H ₄₃ O ₂ P	2-Dicyclohexylphosphino-2',6'-di-i-propoxy-1,1'-biphenyl, min. 98% RuPhos	293
C ₃₀ H ₄₄ BF ₄ FeP ₂ Rh	1,1'-Bis((2R,5R)-2,5-dimethylphospholano)ferrocene(cyclooctadiene)rhodium(I) tetrafluoroborate	351
C ₃₀ H ₄₄ BF ₄ FeP ₂ Rh	1,1'-Bis((2S,5S)-2,5-dimethylphospholano)ferrocene(cyclooctadiene)rhodium(I) tetrafluoroborate	352
C ₃₀ H ₄₇ MoNO ₂	2,6-Diisopropylphenylimidoneophylidene molybdenum(VI) bis(t-butoxide)	137
C ₃₀ H ₄₈ BF ₄ FeP ₂ Rh	1,1'-Bis(di-i-propylphosphino)ferrocene(1,5-cyclooctadiene)rhodium(I) tetrafluoroborate, min. 98%	354
C ₃₀ H ₄₈ BF ₄ P ₂ Rh	(-)-1,2-Bis((2R,5R)-2,5-diethylphospholano)benzene(1,5-cyclooctadiene)rhodium(I) tetrafluoroborate, 98+% (R,R)-Et-DUPHOS-Rh	349
C ₃₀ H ₄₈ FeP ₂	(+)-1,2-Bis((2S,5S)-2,5-diethylphospholano)benzene(1,5-cyclooctadiene)rhodium(I) tetrafluoroborate, 98+% (S,S)-Et-DUPHOS-Rh	349
C ₃₀ H ₄₈ FeP ₂	1,1'-Bis((2R,5R)-2,5-di-i-propylphospholano)ferrocene, min. 97%	98
C ₃₀ H ₄₈ FeP ₂	1,1'-Bis((2S,5S)-2,5-di-i-propylphospholano)ferrocene, min. 97%	98
C ₃₀ H ₅₀ Cl ₂ NO ₃ P ₂ RuS	{[2-(i-Propoxy)-5-(N,N-dimethylaminosulfonyl)phenyl]methylene}(tricyclohexylphosphine)ruthenium(II) dichloride Zhan Catalyst -1C	398
C ₃₀ H ₅₀ O ₄ Ru	Bis(2,2,6,6-tetramethyl-3,5-heptanedionato)(1,5-cyclooctadiene)ruthenium(II), 99% (99.9%-Ru)	366
C ₃₀ H ₅₆ BF ₄ P ₂ Rh	1,2-Bis((2R,5R)-2,5-di-i-propylphospholano)ethane(cyclooctadiene)rhodium(I) tetrafluoroborate	354
C ₃₀ H ₅₆ BF ₄ P ₂ Rh	1,2-Bis((2S,5S)-2,5-di-i-propylphospholano)ethane(cyclooctadiene)rhodium(I) tetrafluoroborate	354
C ₃₀ H ₅₇ BiO ₆	Bismuth(III) neodecanoate, superconductor grade ~60% in neodecanoic acid (15-20% Bi)	23

Formula Index

Formula	Description	Page	Formula	Description	Page
C ₃₀ H ₅₂ O ₈ Y	Yttrium(III) neodecanoate, superconductor grade (12-16% Y) (99.9%-Y) (REO).....	449	C ₃₁ H ₄₈ OP ₂	9,9-Dimethyl-4,5-bis(di-t-butylphosphino)xanthene, min. 97% t-Bu-XANTPHOS.....	298
C ₃₀ H ₆₆ P ₄ Pd	[P.P'-1,3-Bis(di-i-propylphosphino)propane][P-1,3-bis(di-i-propylphosphino)propane]palladium(0), 98%.....	228	C ₃₁ H ₄₈ OP	2-(Di-t-butylphosphino)-3-methoxy-6-methyl-2',4',6'-tri-i-propyl-1,1'-biphenyl, min. 98% RockPhos.....	289
C ₃₁ H ₂₁ ClN ₂ O ₅	2-[2-Chloro-6-hydroxy-5-[2-methylquinolin-8-ylaminomethyl]-3-oxo-3H-xanthen-9-yl]benzoic acid FL.....	191	C ₃₁ H ₄₈ O ₂ P	2-(Di-t-butylphosphino)-3,6-dimethoxy-2',4',6'-tri-i-propyl-1,1'-biphenyl, min. 98% t-BuBrettPhos.....	288
C ₃₁ H ₂₆ NP	(1S,2S)-2-[(4R,11bS)-3,5-Dihydro-4H-dinaphtho[2,1-c:1'-2'-e]phosphepin-4-yl]-1-phenylpropan-2-amine, min. 97%.....	297	C ₃₁ H ₅₀ F ₆ IrNP ₂	(Tricyclohexylphosphine)(1,5-cyclooctadiene)(pyridine)iridium(I)hexafluorophosphate, 99% CRABTREE'S CATALYST.....	93
C ₃₁ H ₂₆ P ₂	(1R,2R)-2-[(4S,11bR)-3,5-Dihydro-4H-dinaphtho[2,1-c:1'-2'-e]phosphepin-4-yl]-1-phenylpropan-2-amine, min. 97%.....	297	C ₃₂ H ₁₂ BF ₂₀ N	N,N-Dimethylaluminum tetra(pentafluorophenyl)borate, 98%.....	27
C ₃₁ H ₂₆ P ₂	(2R,3R)-(-)-2,3-Bis(diphenylphosphino)-bicyclo[2.2.1]hept-5-ene, min. 95% (R,R)-NORPHOS.....	267	C ₃₂ H ₁₂ BF ₂₄ Na	Sodium tetrakis[3,5-bis(trifluoromethyl)phenyl]borate, min. 98% NaBARF.....	421
C ₃₁ H ₃₀ O ₄	(2S,3S)-(+)-2,3-Bis(diphenylphosphino)-bicyclo[2.2.1]hept-5-ene, min. 95% (S,S)-NORPHOS.....	267	C ₃₂ H ₁₆ Cl ₂ N ₆ Si	Silicon(IV) phthalocyanine dichloride, 85% ... Tin(IV) phthalocyanine dichloride.....	410 437
C ₃₁ H ₃₀ O ₄	(4R,5R)-(-)-2,2-Dimethyl-α, α, α', α'-tetraphenyl-1,3-dioxolane-4,5-dimethanol (R,R)-TADDOL.....	218	C ₃₂ H ₁₆ Cl ₂ N ₆ Sn	Cobalt(II) phthalocyanine.....	50
C ₃₁ H ₃₂ O ₂ P ₂	(4S,5S)-(+)-4,5-Bis(diphenylphosphinomethyl)-2,2-dimethyl-1,3-dioxolane, 99.5% (S,S)-DIOP.....	269	C ₃₂ H ₁₆ CoN ₈	Copper(II) phthalocyanine.....	58
C ₃₁ H ₃₂ O ₂ P ₂	(4R,5R)-(-)-4,5-Bis(diphenylphosphinomethyl)-2,2-dimethyl-1,3-dioxolane, 99.5% (R,R)-DIOP.....	269	C ₃₂ H ₁₆ FeN ₈	Iron(II) phthalocyanine, min. 95%.....	109
C ₃₁ H ₃₂ O ₂ Pd	Diacetato[1,3-bis(diphenylphosphino)propane]palladium(II), 99%.....	235	C ₃₂ H ₁₆ MgN ₈ Sn	Magnesium phthalocyanine, min. 90%.....	123
C ₃₁ H ₃₂ ClN ₂ O ₃ RuS	Chloro[N-[(1R,2R)-1,2-diphenyl-2-(2-(4-methylbenzoyloxy)ethylamino)-ethyl]-4-methylbenzene sulfonamide(chloro)ruthenium(II) (R,R)-Ts-DENEB™.....	378	C ₃₂ H ₁₆ MnN ₈	Manganese(II) phthalocyanine, min. 97%.....	127
C ₃₁ H ₃₂ ClN ₂ O ₃ RuS	N-[(1S,2S)-1,2-Diphenyl-2-(2-(4-methylbenzoyloxy)ethylamino)-ethyl]-4-methylbenzene sulfonamide(chloro)ruthenium(II) (S,S)-Ts-DENEB™.....	396	C ₃₂ H ₁₆ N ₆ Na ₂	Sodium phthalocyanine.....	420
C ₃₁ H ₃₂ BF ₄ N ₂ O ₂ RuS	[(1R,2R)-2-Amino-1,2-diphenylethyl][(4-toluenesulfonyl)amido](p-cymene)ruthenium(II) tetrafluoroborate, min. 97%.....	364	C ₃₂ H ₁₆ N ₆ Ni	Nickel(II) phthalocyanine, min. 94%.....	176
C ₃₁ H ₃₂ ClN ₂ O ₂ RuS	[(1S,2S)-2-Amino-1,2-diphenylethyl][(4-toluenesulfonyl)amido](p-cymene)ruthenium(II) tetrafluoroborate, min. 97%.....	364	C ₃₂ H ₁₆ N ₆ Ni	Tin(II) phthalocyanine.....	437
C ₃₁ H ₃₂ ClN ₂ O ₂ RuS	Chloro{[(1R,2R)-(-)-2-amino-1,2-diphenylethyl][(4-toluenesulfonyl)amido](p-cymene)ruthenium(II), min. 95% RuC{[(R,R)-Tsdpen](p-cymene).....	370	C ₃₂ H ₁₆ N ₆ Zn	Zinc phthalocyanine, min. 95%.....	453
C ₃₁ H ₃₂ ClN ₂ O ₂ RuS	Chloro{[(1S,2S)-(+)-2-amino-1,2-diphenylethyl][(4-toluenesulfonyl)amido](p-cymene)ruthenium(II), min. 90% RuC{[(S,S)-Tsdpen](p-cymene).....	370	C ₃₂ H ₁₈ N ₆	Phthalocyanine.....	205
C ₃₁ H ₃₂ BF ₄ N ₂ P ₂ Ru	Allylbis(2-aminoethyl)diphenylphosphino)ruthenium(II) tetrafluoroborate, 98%.....	363	C ₃₂ H ₂₁ O ₄ P	(11bR)-4-Hydroxy-2,6-diphenyl-4-oxide-dinaphtho[2,1-d:1'-2'-f][1,3,2]dioxaphosphepin, 98%, (99% ee).....	314
C ₃₁ H ₃₂ Cl ₂ N ₂ O ₃ Ru	[1,3-Bis(2,4,6-trimethylphenylimidazolidin-2-ylidene)]-(2-i-propoxy-5-nitrobenzylidene)ruthenium(II) dichloride nitro-Grela.....	368	C ₃₂ H ₂₂ O ₂	(2R)-(+)-3,3'-Diphenyl-[2,2'-binaphthalene]-1,1'-diol, min. 98% (R)-VANOL.....	219
C ₃₁ H ₄₄ N ₂ OP ₂	(2S,4S)-(-)-2-(Diphenylphosphinomethyl)-4-(dicyclohexylphosphino)-N-methyl-1-pyrrolidinedecarboxamide, min. 97% (S,S)-MCCPM).....	306	C ₃₂ H ₂₂ O ₂	(2S)-(-)-3,3'-Diphenyl-[2,2'-binaphthalene]-1,1'-diol, min. 98% (S)-VANOL.....	219
C ₃₁ H ₄₄ N ₂ OP ₂	(2R,4R)-(+)-2-(Diphenylphosphinomethyl)-4-(dicyclohexylphosphino)-N-methyl-1-pyrrolidinedecarboxamide, min. 95% (R,R)-MCCPM).....	305	C ₃₂ H ₂₄ F ₆ IrN ₄ P ₄	(2,2'-Bipyridine)bis[2-pyridinyl-kN]phenyl-kC]iridium(III) hexafluorophosphate, 99%.....	86
C ₃₁ H ₄₆ NO ₃ PPdS	Methanesulfonato(tricyclohexylphosphine)(2'-amino-1,1'-biphenyl-2-yl)palladium(II) dichloromethane adduct, min. 98% [PCy3 Palladacycle Gen. 3].....	246	C ₃₂ H ₂₆ N ₂ O ₄ P	1-[(2S)-1-[(11bS)-2,6-Dimethyldinaphtho[2,1-d:1'-2'-f][1,3,2]dioxaphosphepin-4-yloxy]propan-2-yl]-3-phenylurea, min. 97%.....	298
C ₃₁ H ₄₈ F ₃ O ₃ P ₂ RhS	(-)-1,2-Bis((2R,5R)-2,5-diethylphospholano)benzene(1,5-cyclooctadiene)rhodium(I) trifluoromethanesulfonate, 98+% (R,R)-Et-DUPHOS-Rh.....	349	C ₃₂ H ₂₆ O ₄ P	(11bS)-8,9,10,11,12,13,14,15-Octahydro-4-hydroxy-2,6-diphenyl-4-oxide-dinaphtho[2,1-d:1'-2'-f][1,3,2]dioxaphosphepin, 98%, (99% ee).....	317
C ₃₁ H ₄₈ F ₃ O ₃ P ₂ RhS	(+)-1,2-Bis((2S,5S)-2,5-diethylphospholano)benzene(1,5-cyclooctadiene)rhodium(I) trifluoromethanesulfonate, 98+% (S,S)-Et-DUPHOS-Rh.....	349	C ₃₂ H ₃₄ N ₄ O ₄	Deuteroporphyin IX, dimethyl ester, min. 97%.....	193
C ₃₂ H ₃₈ N ₄	Etioporphyrin III.....	291	C ₃₂ H ₃₈ N ₄ P	5-(Di-t-butylphosphino)-1',3',5'-triphenyl-1,4'-bi-1H-pyrazole, min. 95% t-Bu-BipyPhos.....	290
C ₃₂ H ₃₈ BF ₁₀ NO ₂ P ₂ Rh	(-)-2,3-Bis((2R,5R)-2,5-dimethylphospholanyl)-1-[3,5-bis(trifluoromethyl)phenyl]-1H-pyrrole-2,5-dione(1,5-cyclooctadiene)rhodium(I) tetrafluoroborate, min. 97% [cataCXium® FBn].....	291	C ₃₂ H ₃₈ P ₂	1,8-Bis(diphenylphosphino)octane, 99%.....	270
C ₃₂ H ₄₂ Cl ₂ N ₃ O ₂ Ru	Dichloro(1,3-dimesitylimidazolidin-2-ylidene){2-[(ethoxy-2-oxoethylidene)amino]benzylidene} ruthenium(II) HeatMet.....	391	C ₃₂ H ₃₇ Cl ₂ N ₃ O ₂ Ru	Dichloro(1,3-dimesitylimidazolidin-2-ylidene){2-[(ethoxy-2-oxoethylidene)amino]benzylidene} ruthenium(II) HeatMet.....	391
C ₃₂ H ₄₄ BF ₄ P ₂ Rh	(1R,1'R,2S,2'S)-(+)-2,2-Di-t-butyl-2,3,2',3'-tetrahydro-1,1'-bi-1H-isophosphindole(1,5-cyclooctadiene)rhodium(I) tetrafluoroborate, min. 98% (R,R,S,S)-DUANPHOS-Rh.....	357	C ₃₂ H ₄₀ FeP ₂	(R)-(-)-1-(S)-2-(Diphenylphosphino)ferrocenyl[ethyl]di-t-butylphosphine, min. 97%.....	103
C ₃₂ H ₄₄ Cl ₂ N ₃ OP ₂ Rh	Dichloro{1,2-bis((2R,5R)-2,5 dimethylphospholanobenzene)[2-(diphenylphosphino)ethylamino]ruthenium(II), min. 97%.....	382	C ₃₂ H ₄₈ BF ₄ FeP ₂	(-)-1,1'-Bis((2S,4S)-2,4-diethylphosphotano)ferrocene(1,5-cyclooctadiene)rhodium(I) tetrafluoroborate, min. 98%.....	350

Formula Index

Formula	Description	Page
C ₃₂ H ₄₈ NO ₃ PPdS	Methanesulfonato(tricyclohexylphosphino)(2'-methylamino-1,1'-biphenyl-2-yl)palladium(II), 98% [PCy ₃ , Palladacycle Gen. 4].....	247
C ₃₂ H ₅₂ FeP ₂	(R)-(-)-1-(S)-2-(Dicyclohexylphosphino)ferrocenyl]ethyl-di- <i>n</i> -butylphosphine, min. 97%.....	101
C ₃₂ H ₅₂ Rh ₄	Tetrakis(1,5-cyclooctadiene)tetra- μ -hydrido-tetrarhodium, min. 98%.....	360
C ₃₂ H ₅₆ Cl ₂ Ir ₂	Chlorobis(cyclooctene)iridium(I) dimer, 97%.....	87
C ₃₂ H ₅₆ Cl ₂ N ₂ P ₂ Pd	Dichlorobis[4-(<i>N,N</i> -dimethylamino)phenyl]di- <i>n</i> -butylphosphino)palladium(II), min. 98% PdAmphos.....	237
C ₃₂ H ₅₆ Cl ₂ Rh ₂	Chlorobis(cyclooctene)rhodium(I) dimer, min. 98%.....	356
C ₃₂ H ₅₆ N ₂ P ₂ Pd	Bis[4-(<i>N,N</i> -dimethylamino)phenyl]di- <i>n</i> -butylphosphino)palladium(0), min. 98% PdAmphos.....	227
C ₃₂ H ₆₀ NbO ₈	Niobium(IV) 2-ethylhexanoate.....	177
C ₃₂ H ₆₀ O ₈ Mo	Molybdenum(IV) 2-ethylhexanoate (15% Mo).....	138
C ₃₂ H ₆₀ O ₈ Rh ₂	Rhodium(II) octanoate dimer, 98%.....	359
C ₃₂ H ₆₀ O ₈ Sn	Di- <i>n</i> -butyltin dilaurate, 98%.....	435
C ₃₂ H ₆₈ BrP	Trihexyl(tetradecyl)phosphonium bromide, min. 95% CYPHOS® IL 102.....	84
C ₃₂ H ₆₈ AlO ₆	Tetraoctylphosphonium bromide, min. 95%... Trihexyl(tetradecyl)phosphonium chloride, min. 93% CYPHOS® IL 101.....	83
C ₃₂ H ₆₈ ClP	Trihexyl(tetradecyl)phosphonium chloride, min. 93% CYPHOS® IL 101.....	84
C ₃₂ H ₆₈ F ₆ P ₂	Trihexyl(tetradecyl)phosphonium hexafluorophosphate, min. 98% CYPHOS® IL 110.....	84
C ₃₃ H ₁₆ F ₆ IrN ₃	Tris[2-(2,4-difluorophenyl)pyridine]iridium(III), 95%.....	93
C ₃₃ H ₁₉ F ₁₂ O ₄ P	(11aR)-3,7-Bis(3,5-bis(trifluoromethyl)phenyl)-10,11,12,13-tetrahydro-5-hydroxy-5-oxide-diindeno[7,1-de:1',7'-fg][1,3,2]dioxaphosphin, min. 98%.....	255
C ₃₃ H ₁₉ F ₁₂ O ₄ P	(11aS)-3,7-Bis(3,5-bis(trifluoromethyl)phenyl)-10,11,12,13-tetrahydro-5-hydroxy-5-oxide-diindeno[7,1-de:1',7'-fg][1,3,2]dioxaphosphin, min. 98%.....	255
C ₃₃ H ₂₀ F ₁₂ O ₂	(1R)-6,6'-Bis[3,5-bis(trifluoromethyl)phenyl]-2,2',3,3'-tetrahydro-1,1'-spirobi[1H-indene]-7,7'-diol, min. 98%.....	215
C ₃₃ H ₂₀ F ₁₂ O ₂	(1S)-6,6'-Bis[3,5-bis(trifluoromethyl)phenyl]-2,2',3,3'-tetrahydro-1,1'-spirobi[1H-indene]-7,7'-diol, min. 98%.....	215
C ₃₃ H ₂₁ F ₃ IrN ₃	Tris[5-fluoro-2-(2-pyridinyl-kN)phenyl-kC]iridium(III), 95%.....	93
C ₃₃ H ₂₄ IrN ₃	Tris(2-phenylpyridinato-C ₂ ,N)iridium(III), 95%.....	93
C ₃₃ H ₂₆ OP	(R)-(+)-2-(Diphenylphosphino)-2'-methoxy-1,1'-binaphthyl, 99% (R)-MOP.....	305
C ₃₃ H ₂₆ OP	(S)-(-)-2-(Diphenylphosphino)-2'-methoxy-1,1'-binaphthyl, 99% (S)-MOP.....	305
C ₃₃ H ₃₁ O ₄ P	(11aR)-3,7-Bis(3,5-dimethylphenyl)-10,11,12,13-tetrahydro-5-hydroxy-5-oxide-diindeno[7,1-de:1',7'-fg][1,3,2]dioxaphosphin, min. 98%.....	265
C ₃₃ H ₃₁ O ₄ P	(11aS)-3,7-Bis(3,5-dimethylphenyl)-10,11,12,13-tetrahydro-5-hydroxy-5-oxide-diindeno[7,1-de:1',7'-fg][1,3,2]dioxaphosphin, min. 98%.....	265
C ₃₃ H ₃₂ NO ₂ P	(11aR)-(+)-10,11,12,13-Tetrahydrodiindeno[7,1-de:1',7'-fg][1,3,2]dioxaphosphino-5-bis[(R)-1-phenylethyl]amine, min. 98% (R)-SIPHOS-PE.....	321
C ₃₃ H ₃₂ NO ₂ P	(11aS)-(-)-10,11,12,13-Tetrahydrodiindeno[7,1-de:1',7'-fg][1,3,2]dioxaphosphino-5-bis[(R)-1-phenylethyl]amine, min. 98% (S)-SIPHOS-PE.....	321
C ₃₃ H ₃₄ NO ₂ P	(3aR,8aR)-(-)-(2,2-Dimethyl-4,4,8,8-tetraphenyl-tetrahydro-[1,3]dioxolo[4,5-e][1,3,2]dioxaphosphin-6-yl)dimethylamine, min. 98%.....	300
C ₃₃ H ₃₉ N ₆ O ₄ P	1-Benzyl-3-methylimidazolium phosphate, 99%.....	81
C ₃₃ H ₄₂ N ₃ O ₃ P	Methanesulfonato[2-diethylphosphino-2',6'-bis(dimethylamino)-1,1-biphenyl](2'-amino-1,1'-biphenyl-2-yl)palladium(II), min. 98% [EtCPhos Palladacycle Gen. 3].....	245

Formula	Description	Page
C ₃₃ H ₄₃ Cl ₂ N ₃ O ₃ RuS	1,3-Bis(2,4,6-trimethylphenyl)-4,5-dihydroimidazol-2-ylidene[2-(<i>i</i> -propoxy)-5-(<i>N,N</i> -dimethylaminosulfonyl)phenyl]methyleneruthenium(II) dichloride, Zhan Catalyst-1B, min. 96%.....	367
C ₃₃ H ₄₃ N ₃	2,6-Bis[1-(2,6-di- <i>i</i> -propylphenyl)limino]ethyl]pyridine, 98%.....	184
C ₃₃ H ₄₈ OP	2-Dicyclohexylphosphino-2'-methoxy-4',6'-di- <i>n</i> -butyl-1,1'-biphenyl, min. 98% VPhos.....	294
C ₃₃ H ₄₈ P	2-(Dicyclohexylphosphino)-2',4',6'-tri- <i>i</i> -propyl-1,1'-biphenyl, min. 98% XPhos.....	295
C ₃₃ H ₅₃ OP	2-Di- <i>n</i> -butylphosphino-4-methoxy-3,5,6-trimethyl-2',4',6'-tri- <i>i</i> -propyl-1,1'-biphenyl, min. 98% [-1:1 mixture with regioisomer, 2-Di- <i>n</i> -butylphosphino-5-methoxy-3,4,6-trimethyl-2',4',6'-tri- <i>i</i> -propylbi-phenyl].....	289
C ₃₃ H ₅₃ P	2-Di- <i>n</i> -butylphosphino-3,4,5,6-tetramethyl-2',4',6'-tri- <i>i</i> -propyl-1,1'-biphenyl, min. 98% Me ₄ -t-BuXPhos.....	290
C ₃₃ H ₅₆ LuO ₆	Tris(2,2,6,6-tetramethyl-3,5-heptanedionato)lutetium(III), 99% (99.9%-Lu) (REO) [Lu(TMHD) ₃].....	120
C ₃₃ H ₅₇ AlO ₆	Tris(2,2,6,6-tetramethyl-3,5-heptanedionato)aluminum, 99% (99.9%-Al) [Al(TMHD) ₃].....	5
C ₃₃ H ₅₇ BiO ₆	Tris(2,2,6,6-tetramethyl-3,5-heptanedionato)bismuth(III), min. 98% (99.9%-Bi) [Bi(TMHD) ₃].....	24
C ₃₃ H ₅₇ CoO ₆	Tris(2,2,6,6-tetramethyl-3,5-heptanedionato)cobalt(III), 99% (99.9%-Co) [Co(TMHD) ₃].....	53
C ₃₃ H ₅₇ CrO ₆	Tris(2,2,6,6-tetramethyl-3,5-heptanedionato)chromium(III), 99% [Cr(TMHD) ₃].....	46
C ₃₃ H ₅₇ DyO ₆	Tris(2,2,6,6-tetramethyl-3,5-heptanedionato)dysprosium(III), 98+% (99.9%-Dy) (REO) [Dy(TMHD) ₃].....	60
C ₃₃ H ₅₇ ErO ₆	Tris(2,2,6,6-tetramethyl-3,5-heptanedionato)erbium(III), 99% (99.9%-Er) (REO) [Er(TMHD) ₃].....	62
C ₃₃ H ₅₇ EuO ₆	Tris(2,2,6,6-tetramethyl-3,5-heptanedionato)euroium(III), 99% (99.9%-Eu) (REO) [Eu(TMHD) ₃].....	63
C ₃₃ H ₅₇ FeO ₆	Tris(2,2,6,6-tetramethyl-3,5-heptanedionato)iron(III), 99% (99.9%-Fe) [Fe(TMHD) ₃].....	111
C ₃₃ H ₅₇ GaO ₆	Tris(2,2,6,6-tetramethyl-3,5-heptanedionato)gallium(III), 99% (99.999%-Ga) [Ga(TMHD) ₃]PURATREM.....	68
C ₃₃ H ₅₇ GdO ₆	Tris(2,2,6,6-tetramethyl-3,5-heptanedionato)gadolinium(III), 99% (99.9%-Gd) (REO) [Gd(TMHD) ₃].....	67
C ₃₃ H ₅₇ HoO ₆	Tris(2,2,6,6-tetramethyl-3,5-heptanedionato)holmium(III), 99% (99.9%-Ho) (REO) [Ho(TMHD) ₃].....	79
C ₃₃ H ₅₇ InO ₆	Tris(2,2,6,6-tetramethyl-3,5-heptanedionato)indium(III), 99% (99.9%-In) [In(TMHD) ₃].....	81
C ₃₃ H ₅₇ LaO ₆	Tris(2,2,6,6-tetramethyl-3,5-heptanedionato)lanthanum(III), 99% (99.9%-La) (REO) [La(TMHD) ₃].....	113
C ₃₃ H ₅₇ LaO ₆	Tris(2,2,6,6-tetramethyl-3,5-heptanedionato)lanthanum(III) tetraglyme adduct (99.9%-La) (REO).....	113
C ₃₃ H ₅₇ MnO ₆	Tris(2,2,6,6-tetramethyl-3,5-heptanedionato)manganese(III), 99% [Mn(TMHD) ₃].....	127
C ₃₃ H ₅₇ NdO ₆	Tris(2,2,6,6-tetramethyl-3,5-heptanedionato)neodymium(III), 99% (99.9%-Nd) (REO) [Nd(TMHD) ₃].....	170
C ₃₃ H ₅₇ O ₆ Pr	Tris(2,2,6,6-tetramethyl-3,5-heptanedionato)praseodymium(III), 99% (99.9%-Pr) (REO) [Pr(TMHD) ₃].....	346
C ₃₃ H ₅₇ O ₆ Ru	Tris(2,2,6,6-tetramethyl-3,5-heptanedionato)ruthenium(II), 99% (99.9%-Ru) [Ru(TMHD) ₃].....	401
C ₃₃ H ₅₇ O ₆ Sc	Tris(2,2,6,6-tetramethyl-3,5-heptanedionato)scandium(III), 99% (99.9%-Sc) (REO) [Sc(TMHD) ₃].....	403
C ₃₃ H ₅₇ O ₆ Sm	Tris(2,2,6,6-tetramethyl-3,5-heptanedionato)samarium(III) (99.9%-Sm) (REO) [Sm(TMHD) ₃].....	403

Formula Index

Formula	Description	Page
C ₃₃ H ₅₇ O ₆ Tb	Tris(2,2,6,6-tetramethyl-3,5-heptanedionato)terbium(III), 99% (99.9%-Tb) (REO) [Tb(TMHD)] ₃	431
C ₃₃ H ₅₇ O ₆ Ti	Tris(2,2,6,6-tetramethyl-3,5-heptanedionato)titanium(III), min. 97% [Ti(TMHD)] ₃	443
C ₃₃ H ₅₇ O ₆ Tm	Tris(2,2,6,6-tetramethyl-3,5-heptanedionato)thulium(III), 98% (99.9%-Tm) (REO) [Tm(TMHD)] ₃	433
C ₃₃ H ₅₇ O ₆ Y	Tris(2,2,6,6-tetramethyl-3,5-heptanedionato)yttrium(III), 98+ (99.9%-Y) (REO) [Y(TMHD)] ₃	449
C ₃₃ H ₅₇ O ₆ Yb	Tris(2,2,6,6-tetramethyl-3,5-heptanedionato)ytterbium(III), 99% (99.9%-Yb) (REO) [Yb(TMHD)] ₃	447
C ₃₄ H ₁₆ F ₁₆ IrN ₄ P	(2,2'-Bipyridine)bis[3,5-difluoro-2-[5-(trifluoromethyl)-2-pyridinyl-kN][phenyl-kC]iridium(III) hexafluorophosphate, 95%.....	86
C ₃₄ H ₁₉ F ₆ O ₄ P	(11bS)-4-Hydroxy-2,6-bis[4-(trifluoromethyl)phenyl]-4-oxide-dinaphtho[2,1-d':2'-f'] [1,3,2]dioxaphosphepin, 95%, (99% ee).....	313
C ₃₄ H ₂₂ NO ₂ P	(S)-(+)-(3,5-Dioxo-4-phosphacyclohepta[2,1-a;3,4-a']dinaphthalen-4-yl)-5H-dibenz[b,f]azepine, min. 97%.....	301
C ₃₄ H ₂₆ P ₂	1,8-(Diphenylphosphino)naphthalene, 99% ..	307
C ₃₄ H ₂₆ ClNO ₂ Ru	Chlorodicarbonyl[1-(<i>t</i> -propylamino)-2,3,4,5-tetraphenylcyclopentadienyl]ruthenium(II), min. 95%.....	377
C ₃₄ H ₂₆ Cl ₂ Co	Dichloro[1,1'-bis(diphenylphosphino)ferrocene]cobalt(II), 99%.....	51
C ₃₄ H ₂₆ Cl ₂ FeNiP ₂	Dichloro[1,1'-bis(diphenylphosphino)ferrocene]nickel(II), 98%.....	174
C ₃₅ H ₃₀ Cl ₄ FeP ₂	Dichloro 1,1'-bis(diphenylphosphino)ferrocene palladium (II) dichloromethane, 99% ..	238
C ₃₄ H ₂₆ FeP ₂	1,1'-Bis(diphenylphosphino)ferrocene, 99% DPPF.....	97
C ₃₄ H ₂₆ O ₂ Pd	Bis(dibenzylideneacetone)palladium(0).....	227
C ₃₄ H ₂₆ F ₁₂ N ₂ O ₂ P	2-[Bis(3,5-trifluoromethylphenylphosphino)-3,6-dimethoxy]-2',6'-dimethylamino-1,1'-biphenyl, 98%.....	280
C ₃₄ H ₃₀ F ₆ N ₄ O ₁₀	Acetato(2,9-dimethyl-1,10-phenanthroline)palladium(II) dimer bis(trifluoromethanesulfonate), 99%.....	226
C ₃₄ H ₃₀ N ₄	(12a,18a)-5,6,12,12a,13,18,18a,19-Octahydro-5,6-dimethyl-13,18[1',2']benzenobis-benzimidazo [1,2-b:2',1'-d]benzo[[j]]2,5-benzodiazocine potassium triflate adduct.....	204
C ₃₄ H ₃₂ ClFeN ₄ O ₄	Hemin (Ferritroporphyrin IX chloride), min. 95%.....	106
C ₃₄ H ₃₂ N ₃ O ₃ P	1-Benzyl-3-[(1R,2R)-2-[(11bS)-dinaphtho[2,1-d':2'-f'] [1,3,2]dioxaphosphepin-4-ylamino]cyclohexyl]urea, min. 97%.....	251
C ₃₄ H ₃₂ N ₄ O ₄ Zn	Zinc protoporphyrin.....	453
C ₃₄ H ₃₃ P ₃	Bis(2-diphenylphosphinoethyl)phenylphosphine, 97% TRIPHOS.....	268
C ₃₄ H ₃₃ N ₄ O ₄	Protoporphyrin IX.....	207
C ₃₄ H ₃₃ O ₄	(2R,3R)-1,4-Dioxaspiro[4.5]decane-2,3-diylbis(diphenylmethanol), min. 98%.....	218
C ₃₄ H ₃₃ N ₄ O ₄	(2S,3S)-1,4-Dioxaspiro[4.5]decane-2,3-diylbis(diphenylmethanol), min. 98%.....	218
C ₃₄ H ₃₆ P ₂	(+)-1,2-Bis(2S,5S)-2,5-diphenylphospholano)ethane, min. 98% (S,S)-Ph-BPE.....	272
C ₃₄ H ₃₇ NO ₂ P ₂	(-)-1,2-Bis(2R,5R)-2,5-diphenylphospholano)ethane, min. 95% (R,R)-Ph-BPE.....	272
C ₃₄ H ₃₇ NO ₂ P ₂	(2R,4R)-(+)-2-(Diphenylphosphinoethyl)-4-(diphenylphosphino)-N-(<i>t</i> -butoxycarbonyl)pyrrolidine, min. 97% (R,R-BPPM).....	306
C ₃₄ H ₃₇ P	11-Dicyclohexylphosphino-12-phenyl-9,10-ethenoanthracene dichloromethane adduct, min. 98% KITPHOS.....	295
C ₃₄ H ₃₈ F ₆ FeP ₂	(R)-(-)-1-(S)-2-[Bis(4-trifluoromethylphenyl)phosphino]ferrocenyl ethyl-di- <i>t</i> -butylphosphine, min. 97%.....	99
C ₃₄ H ₃₈ N ₄ O ₄	Mesoporphyrin IX dihydrochloride.....	202
C ₃₄ H ₃₈ N ₄ O ₆	Hematoporphyrin IX dihydrochloride.....	200
C ₃₄ H ₄₂ BF ₄ P	Dicyclohexyl[9-(3-phenylpropyl)fluorene-9-yl]phosphonium tetrafluoroborate, min. 95% [cataCXium® FPrPh].....	292

Formula	Description	Page
C ₃₄ H ₄₃ O ₁₀ PS ₃	Dicyclohexyl-[9-[3-(4-sulfonylphenyl)propyl]-2-sulfonylfluorene-9-yl]phosphonium hydrogen sulfate, min. 95% [cataCXium® FSulf].....	295
C ₃₄ H ₄₅ ClNO ₂ P	Chloro(2-dicyclohexylphosphino-2',6'-dimethoxy-1,1'-biphenyl)[2-(2-aminoethylphenyl)]palladium(II) methyl- <i>t</i> -butylether adduct, min. 98% [SPHOS Palladacycle Gen. 1].....	231
C ₃₄ H ₄₆ NO ₂ P	(2S,4S)-(-)-2-(Diphenylphosphinoethyl)-4-(diphenylphosphino)-N-(<i>t</i> -butoxycarbonyl)pyrrolidine, min. 97% (S,S-BPPM).....	306
C ₃₄ H ₄₆ NO ₂ P ₂	(2R,4R)-(+)-2-(Diphenylphosphinoethyl)-4-(dicyclohexylphosphino)-N-(<i>t</i> -butoxycarbonyl)pyrrolidine, min. 97% (R,R-BCPM).....	305
C ₃₄ H ₅₂ BF ₄ FeP ₂ Rh	1,1'-Bis(2R,5R)-2,5-diethylphospholano)ferrocene(cyclooctadiene)rhodium(I) tetrafluoroborate.....	350
C ₃₄ H ₅₂ BF ₄ FeP ₂ Rh	1,1'-Bis(2S,5S)-2,5-diethylphospholano)ferrocene(cyclooctadiene)rhodium(I) tetrafluoroborate.....	350
C ₃₄ H ₅₂ Cl ₂ FeP ₂ Pd	Dichloro[1,1'-bis(dicyclohexylphosphino)ferrocene]palladium(II), dichloromethane adduct, 99%.....	237
C ₃₄ H ₅₂ FeP ₂	1,1'-Bis(dicyclohexylphosphino)ferrocene, min. 98%.....	95
C ₃₄ H ₅₆ BF ₄ P ₂ Rh	(+)-1,2-Bis(2R,5R)-2,5-di- <i>i</i> -propylphospholano)benzene(1,5-cyclooctadiene)rhodium(I) tetrafluoroborate, min. 98% (R,R)-i-Pr-DUPHOS-Rh.....	354
C ₃₄ H ₅₆ ClN	Tetraoctylammonium chloride, min. 97%.....	169
C ₃₄ H ₆₈ F ₆ NO ₄ PS ₂	Trihexyl(tetradecyl)phosphonium bis(trifluoromethanesulfonyl)amide, min. 97% CYPHOS® IL 109.....	83
C ₃₄ H ₆₉ N ₃ P	Trihexyl(tetradecyl)phosphonium dicyanamide, min. 95% CYPHOS® IL 105.....	84
C ₃₅ H ₂₆	1,2,3,4,5-Pentaphenyl-1,3-cyclopentadiene, 99%.....	39
C ₃₅ H ₃₀ N ₂ O ₂	(R)-7,7'-Bis[(4S)-(phenyl)oxazol-2-yl]-2,2',3,3'-tetrahydro-1,1'-spirobiindane, min. 97% (Ra,S,S)-SpiroBOX.....	187
C ₃₅ H ₃₀ N ₂ O ₂	(S)-7,7'-Bis[(4S)-(phenyl)oxazol-2-yl]-2,2',3,3'-tetrahydro-1,1'-spirobiindane, min. 97% (Sa,S,S)-SpiroBOX.....	187
C ₃₅ H ₃₆ ClN ₂	(S)-4,5-Dihydro-1,3-bis-[(2,2)paracyclophan-4-yl]imidazolium chloride, min. 97%..	196
C ₃₅ H ₃₆ Cl ₂ O ₆ Ti	(4R,5R)-(-)-2,2-Dimethyl- $\alpha,\alpha,\alpha',\alpha'$ -tetraphenyl-1,3-dioxolane-4,5-dimethanolato[1,2-bis(dimethoxy)ethane]titanium(IV) dichloride acetonitrile adduct.....	440
C ₃₅ H ₃₆ OP	11-Dicyclohexylphosphino-12-(2-methoxyphenyl)-9,10-ethenoanthracene dichloromethane adduct, min. 98% o-MeO-KITPHOS.....	294
C ₃₅ H ₄₃ BF ₄ N ₄ Pd	[1,3-Bis(2,4,6-trimethylphenyl)-4,5-dihydroimidazol-2-ylidene][2-[(dimethylamino-kN)methyl]phenyl-kC](pyridine)palladium (II) tetrafluoroborate, min. 97% PACC™.....	228
C ₃₅ H ₄₆ N ₂ O ₃ P	Methanesulfonato[2-(di- <i>t</i> -butylphosphino)-2'-(N,N-dimethylamino)-1,1'-biphenyl]dichloromethane adduct, min. 98% [t-Bu-DavePhos Palladacycle Gen. 3].....	242
C ₃₅ H ₄₆ Cl ₃ N ₃ ORu	[1,3-Bis(2,4,6-trimethylphenyl)-4-[(trimethylammonio)methyl]imidazolide-2-ylidene][2-(<i>i</i> -propoxybenzylidene)dichlororuthenium(II) chloride StickyCat Cl ...	368
C ₃₅ H ₅₃ ClN ₂	1,3-Bis[2,6-bis(1-ethylpropyl)phenyl]imidazolium chloride, 98% IPentHCl.....	181
C ₃₅ H ₅₃ O ₂ P	2-(Dicyclohexylphosphino)-3,6-dimethoxy-2',4',6'-tri- <i>i</i> -propyl-1,1'-biphenyl, min. 98% BrettPhos.....	293
C ₃₅ H ₁₇ F ₁₂ O ₄ P	(11bR)-2,6-Bis[3,5-bis(trifluoromethyl)phenyl]-4-hydroxy-4-oxide-dinaphtho[2,1-d':2'-f'] [1,3,2]dioxaphosphepin, 98%, (99% ee).....	254

Formula Index

Formula	Description	Page
C ₃₆ H ₂₄ F ₁₂ IrN ₃	Tris[(2-(2-pyridinyl)kN)-5-(trifluoromethyl)phenyl-kC]iridium(III), 95%.....	93
C ₃₆ H ₂₄ F ₁₂ N ₆ RuP ₂	Tris(1,10-phenanthroline)ruthenium(II) hexafluorophosphate, 95%.....	401
C ₃₆ H ₂₆ OP ₂	4,6-Bis(diphenylphosphino) dibenzofuran, 98% DBFphos.....	267
C ₃₆ H ₂₇ NOP ₂	4,6-Bis(diphenylphosphino) phenoxazine, min. 98% NIXANTPHOS.....	270
C ₃₆ H ₂₈ Cl ₂ O ₂ Pd	Dichloro[bis(2-(diphenylphosphino)phenyl) ether]palladium(II), 98%.....	238
C ₃₆ H ₂₈ OP ₂	Bis(2-diphenylphosphinophenyl)ether, 98% DPEphos.....	270
C ₃₆ H ₂₈ P ₂	2,2'-Bis(diphenylphosphino)-1,1'-biphenyl, 98% BIPHEP.....	267
C ₃₆ H ₂₉ N ₂ O ₄ P	1-(1R,2S)-1-(11bR)-Dinaphtho[2,1-d:1',2'-f][1,3,2]dioxaphosphepin-4-yloxy]-1-phenylpropan-2-yl]-3-phenylurea, min. 97%.....	300
C ₃₆ H ₃₀ Br ₂ NiP ₂	Bis(triphenylphosphine)nickel(II) bromide, 99%.....	173
C ₃₆ H ₃₀ Br ₂ P ₂ Pd	trans-Dibromobis(triphenylphosphine) palladium(II), 99%.....	236
C ₃₆ H ₃₀ ClNP ₂	Bis(triphenylphosphine)iminium chloride, 97%.....	281
C ₃₆ H ₃₀ Cl ₂ CoP ₂	Dichlorobis(triphenylphosphine)cobalt(II), 98%.....	51
C ₃₆ H ₃₀ Cl ₂ NiP ₂	Bis(triphenylphosphine)nickel(II) chloride, 99%.....	173
C ₃₆ H ₃₀ Cl ₂ P ₂ Pd	trans-Dichlorobis(triphenylphosphine)palladium(II), 99% (99.9+%-Pd).....	238
C ₃₆ H ₃₀ Cl ₂ P ₂ Pt	trans-Dichlorobis(triphenylphosphine) palladium(II)/potassium phosphate admixture [CatKit single-use vials - 6.32 wt% Pd complex].....	239
C ₃₆ H ₃₀ Cl ₂ P ₂ Pt	cis-Dichlorobis(triphenylphosphine)platinum(II), 98%.....	337
C ₃₆ H ₃₀ CuNO ₃ P ₂	Bis(triphenylphosphine)copper(II) nitrate, 99%.....	55
C ₃₆ H ₃₀ I ₂ O ₂ P ₂ Re	Iododioxobis(triphenylphosphine)rhenium(V), 98%.....	347
C ₃₆ H ₃₀ NO ₂ P	(S)-(+)-(3,5-Dioxa-4-phospha-cyclohepta[2,1-a:3,4-a']dinaphthalen-4-yl) bis[(1R)-1-phenylethyl]amine, dichloromethane adduct, min. 95%.....	301
C ₃₆ H ₃₀ NP	(S)-(+)-(3,5-Dioxa-4-phospha-cyclohepta[2,1-a:3,4-a']dinaphthalen-4-yl) bis[(1S)-1-phenylethyl]amine, min. 95%.....	301
C ₃₆ H ₃₀ NP	(1S,2S)-2-[(4R,11bS)-3,5-Dihydro-4H-dinaphtho[2,1-c:1',2'-e]phosphepin-4-yl]-1,2-diphenylethanamine, min. 97%.....	297
C ₃₆ H ₃₀ Pb ₂	(1R,2R)-2-[(4S,11bR)-3,5-Dihydro-4H-dinaphtho[2,1-c:1',2'-e]phosphepin-4-yl]-1,2-diphenylethanamine, min. 97%.....	297
C ₃₆ H ₃₀ Pb ₂	Hexaphenyldilead, min. 98%.....	114
C ₃₆ H ₃₀ Sn ₂	Hexaphenylditin, 99+%.....	435
C ₃₆ H ₃₁ F ₁₂ O ₄ P	2-[Bis(3,5-trifluoromethylphenylphosphino)-3,6-dimethoxy]-2',6'-di-n-propoxy-1,1'-biphenyl, 98%.....	280
C ₃₆ H ₃₂ F ₆ N ₄ O ₆ S ₂	11,12-Bis[N-methyl-1H-benzimidazolium-3-methylene]-9,10-dihydro-9,10-ethanoanthracene bis(trifluoromethanesulfonate)....	186
C ₃₆ H ₃₄ BNP ₂	Bis(triphenylphosphine)iminium borohydride, min. 97%.....	281
C ₃₆ H ₃₆ F ₁₂ N ₆ RuP ₂	Tris(4,4'-dimethyl-2,2'-bipyridine)ruthenium(II) hexafluorophosphate, 95%, DMBPY... (S)-(+)-1-[(R)-2-(Di-2-furylphosphino)ferrocenyl]ethylidene]-3,5-xylylphosphine, min. 97%.....	401
C ₃₆ H ₃₆ FeO ₂ P ₂	Cucurbit[6]uril (CB[6]) hydrate, 99+%.....	102
C ₃₆ H ₃₈ N ₂ O ₁₂	1-[(1S,2R)-1-(11bR)-8,9,10,11,12,13,14,15-Octahydrodinaphtho[2,1-d:1',2'-f][1,3,2]dioxaphosphepin-4-yloxy]-1-phenylpropan-2-yl]-3-phenylurea, min. 97%.....	192
C ₃₆ H ₃₇ N ₂ O ₄ P	(11bR)-2,6-Bis(3,5-dimethylphenyl)-8,9,10,11,12,13,14,15-octahydro-4-hydroxy-4-oxide-dinaphtho[2,1-d:1',2'-f][1,3,2]dioxaphosphepin, 98%, (99% ee).....	316
C ₃₆ H ₃₇ O ₄ P	(11bR)-2,6-Bis(3,5-dimethylphenyl)-8,9,10,11,12,13,14,15-octahydro-4-hydroxy-4-oxide-dinaphtho[2,1-d:1',2'-f][1,3,2]dioxaphosphepin, 98%, (99% ee).....	264

Formula	Description	Page
(11bS)-2,6-Bis(3,5-dimethylphenyl)-8,9,10,11,12,13,14,15-octahydro-4-hydroxy-4-oxide-dinaphtho[2,1-d:1',2'-f][1,3,2]dioxaphosphepin, 98%, (99% ee).....		264
C ₃₆ H ₃₈ N ₄ O ₄	Protoporphyrin IX, dimethyl ester.....	207
C ₃₆ H ₃₈ N ₄ O ₈	Coproporphyrin III dihydrochloride (synthetic). Coproporphyrin III dihydrochloride.....	191
C ₃₆ H ₃₈ N ₄ P	5-(Dicyclohexylphosphino)-1',3',5'-triphenyl-[1,4']-bi-1H-pyrazole, min. 95% Cy-BipyPhos.....	192
C ₃₆ H ₄₀ BF ₄ N ₃ O ₂ RuS	(((1R,2R)-2-Amino-1,2-diphenylethyl)[4-toluenesulfonyl]amido)(p-cymene)(pyridine) ruthenium(II) tetrafluoroborate, min. 97%.....	295
C ₃₆ H ₄₀ BF ₄ O ₂ P ₂ Rh	((R,R)-(-)-1,2-Bis((o-methoxyphenyl)(phenyl) phosphino)ethane(1,5-cyclooctadiene)rhodium(I) tetrafluoroborate, min. 97%.....	363
C ₃₆ H ₄₀ BF ₄ O ₂ P ₂ Rh	((R,R)-(-)-1,2-Bis((o-methoxyphenyl)(phenyl) phosphino)ethane(1,5-cyclooctadiene)rhodium(I) tetrafluoroborate, min. 95%.....	355
C ₃₆ H ₄₀ BF ₄ P ₂ Rh	(S,S)-(+)-1,2-Bis((o-methoxyphenyl)(phenyl) phosphino)ethane(1,5-cyclooctadiene)rhodium(I) tetrafluoroborate, min. 98%.....	353
C ₃₆ H ₄₁ N ₂ O ₄ PS	4-Butyl-N-[(11bR)-dinaphtho[2,1-d:1',2'-f][1,3,2]dioxaphosphepin-4-yl]benzenesulfonamide triethylamine adduct, min. 97%.....	282
C ₃₆ H ₄₁ N ₂ O ₄ PSi ₂	1-(2S)-1-[(11bR)-2,6-Bis(trimethylsilyl) dinaphtho[2,1-d:1',2'-f][1,3,2]dioxaphosphepin-4-yloxy]propan-2-yl]-3-phenylurea, min. 97%.....	281
C ₃₆ H ₄₂ N ₄ O ₄	Mesoporphyrin IX, dimethyl ester, 97%.....	202
C ₃₆ H ₄₄ FeP ₂	(S)-(+)-1-[(R)-2-(Dicyclohexylphosphino)ferrocenyl]ethylidiphenylphosphine, min. 97%.....	101
C ₃₆ H ₄₄ N ₄ OV	(R)-(-)-1-[(S)-2-(Diphenylphosphino)ferrocenyl]ethylidicyclohexylphosphine ethanol adduct, min. 97% (R)-(S)-JOSIPHOS.....	104
C ₃₆ H ₄₄ CIN ₂ Pd	(S)-(+)-1-[(R)-2-(Diphenylphosphino)ferrocenyl]ethylidicyclohexylphosphine ethanol adduct, min. 97% (S)-(R)-JOSIPHOS.....	104
C ₃₆ H ₄₄ CIN ₂ Pd	(R)-(-)-1-[(S)-2-(Dicyclohexylphosphino)ferrocenyl]ethylidiphenylphosphine, min. 97%.....	101
C ₃₆ H ₄₄ CIN ₂ Pd	Vanadyl octaethylporphine.....	446
C ₃₆ H ₄₆ CIN ₂ Pd	Chloro[(1,2,3-n)-3-phenyl-2-propenyl][1,3-bis(2,6-di-n-propylphenyl)imidazo[ol-2-ylidene]palladium(II), min. 97%.....	234
C ₃₆ H ₄₆ CIN ₂ OPd	Chloro[2-[1-(N-methoxy)iminoethyl]phenyl][1,3-bis(2,6-di-n-propylphenyl)imidazole-2-ylidene]palladium(II).....	233
C ₃₆ H ₄₆ N ₄	Octaethylporphine, 97+ OEP.....	204
C ₃₆ H ₄₇ CIN ₂ Pd	Chloro[(1,2,3-n)-3-phenyl-2-propenyl][1,3-bis(2,6-di-n-propylphenyl)-4,5-dihydroimidazol-2-ylidene]palladium(II), min. 97%.....	234
C ₃₆ H ₅₂ AlClN ₂ O ₂	(1R,2R)-(-)[1,2-Cyclohexanediamino-N,N'-bis(3,5-di-t-butylsalicylidene)]aluminum(III) chloride, 98%.....	3
C ₃₆ H ₅₂ AlClN ₂ O ₂	(1S,2S)-(+)[1,2-Cyclohexanediamino-N,N'-bis(3,5-di-t-butylsalicylidene)]aluminum(III) chloride, 98%.....	3
C ₃₆ H ₅₂ ClCrN ₂ O ₂	(1R,2R)-(-)[1,2-Cyclohexanediamino-N,N'-bis(3,5-di-t-butylsalicylidene)]chromium(III) chloride.....	46
C ₃₆ H ₅₂ ClCrN ₂ O ₂	(1S,2S)-(+)[1,2-Cyclohexanediamino-N,N'-bis(3,5-di-t-butylsalicylidene)]chromium(III) chloride.....	46
C ₃₆ H ₅₂ CIMn	(1R,2R)-(-)[1,2-Cyclohexanediamino-N,N'-bis(3,5-di-t-butylsalicylidene)]manganese(III) chloride, 98% (R,R)-Jacobsen Cat.....	125
N ₂ O ₂	(1S,2S)-(+)[1,2-Cyclohexanediamino-N,N'-bis(3,5-di-t-butylsalicylidene)]manganese(III) chloride, 98% (S,S)-Jacobsen Cat.....	125
C ₃₆ H ₅₂ CoN ₂ O ₂	(1R,2R)-(-)-1,2-Cyclohexanediamino-N,N'-bis(3,5-di-t-butylsalicylidene) cobalt(II).....	51

Formula Index

Formula	Description	Page	Formula	Description	Page
	(1S,2S)-(+)-1,2-Cyclohexanediamino-N,N'-bis(3,5-di-t-butylsalicylidene)cobalt(II).....	51	C ₃₈ H ₂₄ F ₄ O ₄ P ₂	R-(-)-5,5'-Bis(diphenylphosphino)-2,2,2',2'-tetrafluoro-4,4'-bi-1,3-benzodioxole, dichloromethane adduct, min. 97% (R)-DIFLUORPHOS™.....	271
C ₃₈ H ₅₂ OP ₂	Bis(2-dicyclohexylphosphinophenyl)ether, 98%.....	258		S-(+)-5,5'-Bis(diphenylphosphino)-2,2,2',2'-tetrafluoro-4,4'-bi-1,3-benzodioxole, dichloromethane adduct, min. 97% (S)-DIFLUORPHOS™.....	271
C ₃₈ H ₅₂ P ₂	2,2'-Bis(dicyclohexylphosphino)-1,1'-biphenyl, min. 97%.....	258	C ₃₈ H ₂₈ O ₄ P ₂	(R)-(+)-5,5'-Bis(diphenylphosphino)-4,4'-bi-1,3-benzodioxole, min. 98% (R)-(+)-SEGPLHOS®.....	266
C ₃₈ H ₅₄ Cl ₂ NiP ₂	trans-Bis(dicyclohexylphenylphosphino)nickel(II) chloride, 99%.....	172		(S)-(-)-5,5'-Bis(diphenylphosphino)-4,4'-bi-1,3-benzodioxole, min. 98% (S)-(-)-SEGPLHOS®.....	266
C ₃₈ H ₅₄ N ₂ O ₂	(1R,2R)-(-)-1,2-Cyclohexanediamino-N,N'-bis(3,5-di-t-butylsalicylidene), 98% (R,R)-Jacobsen Ligand.....	193	C ₃₈ H ₂₀ N ₂ OP	(R)-(+)-4-[2-(Diphenylphosphino)-1-naphthalenyl]-N-[(R)-1-phenylethoxy]phthalazine, min. 97% (R,R)-O-PINAP.....	307
	(1S,2S)-(+)-1,2-Cyclohexanediamino-N,N'-bis(3,5-di-t-butylsalicylidene), 98% (S,S)-Jacobsen Ligand.....	193		(S)-(-)-4-[2-(Diphenylphosphino)-1-naphthalenyl]-N-[(R)-1-phenylethoxy]phthalazine, min. 97% (R,S)-O-PINAP.....	307
C ₃₈ H ₅₆ FeP ₂	(R)-(-)-1-[(S)-2-(Dicyclohexylphosphino)ferrocenyl]ethyl(dicyclohexylphosphine), min. 97%.....	101	C ₃₈ H ₃₀ Cl ₂ O ₂ P ₂	(R)-(+)-5,5'-Dichloro-6,6'-dimethoxy-2,2'-bis(diphenylphosphino)-1,1'-biphenyl, min. 95% (R)-Cl-MeO-BIPHEP.....	291
	(S)-(+)-1-[(R)-2-(Dicyclohexylphosphino)ferrocenyl]ethyl(dicyclohexylphosphine), min. 97%.....	101		(S)-(-)-5,5'-Dichloro-6,6'-dimethoxy-2,2'-bis(diphenylphosphino)-1,1'-biphenyl, min. 95% (S)-Cl-MeO-BIPHEP.....	291
C ₃₈ H ₆₆ Cl ₂ NiP ₂	Bis(tricyclohexylphosphine)nickel(II) chloride, 99%.....	173	C ₃₈ H ₃₀ Cl ₂ O ₂ P ₂	Dichlorodicyclohexylbis(triphenylphosphine)ruthenium(II), min. 98%.....	391
C ₃₈ H ₆₆ Cl ₂ P ₂ Pd	trans-Dichlorobis(tricyclohexylphosphine)palladium(II), 99%.....	238	C ₃₈ H ₃₀ N ₃ P	(R)-(+)-4-[2-(Diphenylphosphino)-1-naphthalenyl]-N-[(R)-1-phenylethyl]-1-phthalazinamine, min. 97% (R,R)-N-PINAP.....	307
	trans-Dichlorobis(tricyclohexylphosphine)palladium(II)/potassium phosphate admixture [CatKit single-use vials - 6.62 wt% Pd complex].....	238		(S)-(-)-4-[2-(Diphenylphosphino)-1-naphthalenyl]-N-[(R)-1-phenylethyl]-1-phthalazinamine, min. 97% (R,S)-N-PINAP.....	307
C ₃₈ H ₆₆ P ₂ Pd	Bis(tricyclohexylphosphine)palladium(0), 98%.....	228	C ₃₈ H ₃₀ NiO ₂ P ₂	Bis(triphenylphosphine)nickel dicarbonyl, 98%.....	173
C ₃₈ H ₇₀ BaO ₄	Barium stearate, tech. gr.....	12	C ₃₈ H ₃₂ O ₂ P ₂	(R)-(+)-2,2'-Bis(diphenylphosphino)-6,6'-dimethoxy-1,1'-biphenyl, min. 97% (R)-MeO-BIPHEP.....	268
C ₃₈ H ₇₀ CaO ₄	Calcium stearate, min. 85%.....	36		(S)-(-)-2,2'-Bis(diphenylphosphino)-6,6'-dimethoxy-1,1'-biphenyl, min. 97% (S)-MeO-BIPHEP.....	268
C ₃₈ H ₇₀ CoO ₄	Cobalt stearate (9-10% Co).....	50	C ₃₈ H ₃₂ P ₂	2,2'-Bis(diphenylphosphinomethyl)-1,1'-biphenyl, 99% BISBL.....	269
C ₃₈ H ₇₀ FeO ₄	Iron(II) stearate (9% Fe).....	109	C ₃₈ H ₃₃ N ₂ O ₄ P	1-[(1S,2R)-1-[(11bR)-2,6-Dimethyldinaphtho[2,1-d:1',2'-f][1,3,2]dioxaphosphin-4-yloxy]-1-phenylpropan-2-yl]-3-phenylurea, min. 97%.....	298
C ₃₈ H ₇₀ NiO ₄	Nickel(II) stearate.....	176		(11bR)-N,N-Bis[(R)-(-)-1-(2-methoxyphenyl)ethyl]dinaphtho[2,1-d:1',2'-f][1,3,2]dioxaphosphin-4-amine, min. 98%.....	277
C ₃₇ H ₁₅ F ₁₅ N ₄	5,10,15-Tri(pentafluorophenyl)corrole.....	212	C ₃₈ H ₃₄ NO ₄ P	(11bS)-N,N-Bis[(S)-(+)-1-(2-methoxyphenyl)ethyl]dinaphtho[2,1-d:1',2'-f][1,3,2]dioxaphosphin-4-amine, min. 98%.....	277
C ₃₇ H ₃₀ ClIrOP ₂	Chlorocarbonylbis(triphenylphosphine)iridium(I), 99% VASKA'S COMPLEX.....	87	C ₃₈ H ₃₈ N ₄	11,12-Bis[1,3-dihydro-3-(i-propyl)-2H-benzimidazol-2-ylidene]-3-methylene]-9,10-dihydro-9,10-ethanoanthracene.....	182
C ₃₇ H ₃₀ ClOP ₂ Rh	Chlorocarbonylbis(triphenylphosphine)rhodium(I), 99%.....	356	C ₃₈ H ₄₆ ClNO ₂ P	Chloro(2-dicyclohexylphosphino)-2',6'-dimethoxy-1,1'-biphenyl(2'-amino-1,1'-biphenyl-2-yl) palladium(II) min. 98% [SPhos Palladacycle Gen. 2].....	231
C ₃₇ H ₃₁ P ₃	1,1,1-(diphenylphosphino)methane, 97%.....	331	C ₃₈ H ₄₆ Cl ₂ PPd	Chloro[2-(dicyclohexylphosphino)-2'-(N,N-dimethylamino)-1,1'-biphenyl](2'-amino-1,1'-biphenyl-2-yl)palladium(II), min. 98% [DavePhos Palladacycle Gen. 2].....	232
C ₃₇ H ₃₁ NPS	(R)-(+)-7-[N-(2-Phenylthio)ethylamino]-7-[diphenylphosphino]-2,2',3,3'-tetrahydro-1,1'-spiroindane, 97+% (>99% ee) [(R)-Ph-SpiroSAP-Ph].....	319	C ₃₈ H ₄₆ P ₂	racemic-trans-1,2-Bis[di(3,5-dimethylphenyl)phosphinomethyl]cyclobutane, min. 95%.....	261
	(R)-1-[(S)-2-Diphenylphosphinoferrocenyl](N-methyl)(N-diphenylphosphino)ethylamine (R)-Me-Bophoz.....	104	C ₃₈ H ₅₀ Cl ₂ Zr	(+)-Bis[1-[(1'R,2'R,5'R)-2'-i-propyl-5'-methylcyclohexyl]indenyl]zirconium(IV) dichloride.....	455
	(S)-1-[(R)-2-Diphenylphosphinoferrocenyl](N-methyl)(N-diphenylphosphino)ethylamine (S)-Me-Bophoz.....	104	C ₃₈ H ₅₃ ClNO ₂ P	Chloro(2-dicyclohexylphosphino)-2',6'-dimethoxy-1,1'-propoxy-1,1'-biphenyl [2-(2-aminoethylphenyl)palladium(II), methyl-t-butylether adduct, min. 98% [RuPhos Palladacycle Gen. 1].....	232
C ₃₇ H ₄₁ ClNiO ₃ P ₂	Chloro(2-methylphenyl)[1,3,5,7-tetramethyl-8-(2-di-o-tolylphosphinophenyl)-2,4,6-tri-oxa-8-phosphaadamantane]nickel(II), Stradiotto PAd-DalPhos Nickel Catalyst.....	174			
C ₃₇ H ₄₇ IrF ₆ IrN ₂ P ₂	(Dimethylphosphino)(1,5-cyclooctadiene)[1,3-bis(2,4,6-trimethylphenyl)imidazol-2-ylidene]iridium(I) hexafluorophosphate, min. 98%.....	91			
C ₃₇ H ₅₁ O ₃ P	2-[Bis(3,5-di-t-butyl-4-methoxyphenyl)phosphino]benzaldehyde, min. 97%.....	256			
C ₃₇ H ₅₂ NO ₃ PPdS	Methanesulfonato(diadamantyl-n-butylphosphino)-2'-amino-1,1'-biphenyl-2-yl) palladium(II) dichloromethane adduct, min. 95% [cataCXium® A Palladacycle Gen. 3].....	241			
C ₃₇ H ₅₅ CINPPd	Chloro(2-di-t-butylphosphino)-2',4',6'-tri-i-propyl-1,1'-biphenyl][2-(2-aminoethyl)phenyl] palladium(II), min. 98% [t-BuXPhos Palladacycle Gen. 1].....	231			
C ₃₇ H ₅₆ CuF ₃ O ₅ P ₄ S	Bis[1-(2R,5R)-2,5-dimethylphospholanyl]-[2-(2R,5R)-2,5-dimethylphospholanyl-1-oxide]benzene)copper(I) trifluoromethanesulfonate, min. 97%.....	55			
	Bis[1-(2S,5S)-2,5-dimethylphospholanyl]-[2-(2S,5S)-2,5-dimethylphospholanyl-1-oxide]benzene)copper(I) trifluoromethanesulfonate, min. 97%.....	55			

Formula Index

Formula	Description	Page
C ₃₈ H ₆₀ BF ₄ FeP ₂ Rh	1,1'-Bis((2R,5R)-2,5-di- <i>i</i> -propylphospholano)ferrocene(cyclooctadiene)rhodium(I) tetrafluoroborate	354
C ₃₉ H ₃₂ Cl ₂ OP ₂	Dichloro[9,9-dimethyl-4,5-bis(diphenylphosphino)xanthene]palladium(II), min. 98%	239
C ₃₉ H ₃₂ OP ₂	9,9-Dimethyl-4,5-bis(diphenylphosphino)xanthene, min. 98% XANTPHOS	298
C ₃₉ H ₃₂ O ₂ P ₂	R-(-)-1,13-Bis(diphenylphosphino)-7,8-dihydro-6H-dibenzof[h,i][1,5]dioxin, 97% (R)-C ₂ -TUNEPHOS	268
C ₃₉ H ₃₄ NOP	(R)-(+)-7-[4(S)-(Benzyl)oxazol-2-yl]-7-diphenylphosphino-2,2',3,3'-tetrahydro-1,1'-spirobiindane, min. 97% (Ra,S)-Ph-Bn-SIPHOX	252
C ₃₉ H ₃₄ P ₂	Bis[2-(4-methyldiphenylphosphino)phenyl]methane, 90%	278
C ₃₉ H ₃₇ F ₁₂ O ₂ P	2-Di[3,5-bis(trifluoromethyl)phenylphosphino]-3,6-dimethoxy-2',4',6'-tri- <i>i</i> -propyl-1,1'-biphenyl, min. 98% JackiePhos	285
C ₃₉ H ₄₀ BF ₄ P ₂ Rh	(2S,3S)-(+)-2,3-Bis(diphenylphosphino)bicyclo[2.2.1]hept-5-ene(1,5-cyclooctadiene)rhodium(I) tetrafluoroborate, min. 97% (S,S)-NORPHOS-Rh	353
C ₃₉ H ₄₂ ClF ₂ FeNiP ₂	Chloro(4-cyanophenyl)((R)-1-[(S)-2-(bis(4-fluorophenyl)phosphino)ferrocenyl]ethyl(di- <i>t</i> -butylphosphine))nickel(II)	173
C ₃₉ H ₄₄ ClFeNiP ₂	Chloro(4-cyanophenyl)((R)-1-[(S)-2-(diphenylphosphino)ferrocenyl]ethyl(di- <i>t</i> -butyl)phosphine)nickel(II)	174
C ₃₉ H ₄₈ NO ₅ PPdS	Methanesulfonato(2-dicyclohexylphosphino-2',6'-dimethoxy-1,1'-biphenyl)(2'-amino-1,1'-biphenyl-2-yl)palladium(II) dichloromethane adduct, min. 98% [SPhos Palladacycle Gen. 3]	243
C ₃₉ H ₄₉ N ₂ O ₃ P PdS	Methanesulfonato(2-dicyclohexylphosphino-2'- <i>N,N</i> -dimethylamino-1,1'-biphenyl)(2'-amino-1,1'-biphenyl-2-yl)palladium(II) CH ₂ Cl ₂ adduct, min. 98% [DavePhos Palladacycle Gen. 3]	244
C ₃₉ H ₅₀ Cl ₂ F ₃ N ₃ O ₂ Ru	[1,3-Bis(2,6-di- <i>i</i> -propylphenyl)-4,5-dihydroimidazol-2-ylidene]-[2- <i>i</i> -propoxy-5-(trifluoroacetamido)phenyl]methyleneruthenium(II) dichloride M71-S1Pr	365
C ₃₉ H ₅₂ ClO ₂ PPd	Chloro(1- <i>t</i> -butylidene)[2-(dicyclohexylphosphino)-2',6'-dimethoxy-1,1'-biphenyl]palladium(II)	230
C ₃₉ H ₅₃ Cl ₂ N ₃ O ₃ Ru	[1,3-Bis(2,6-di- <i>i</i> -propylphenyl)imidazolidin-2-ylidene][2-[[1-(methoxy(methyl)amino)-1-oxopropan-2-yl]oxy]benzylidene]ruthenium(II) dichloride GreenCat	365
C ₃₉ H ₅₅ Cl ₃ N ₄ ORu	[1,3-Bis(2,4,6-trimethylphenyl)-4-[[4-ethyl-4-methylpiperazin-1-ium-1-yl)methyl]imidazolidin-2-ylidene]-[2- <i>i</i> -propoxybenzylidene]dichlororuthenium(II) chloride AquaMet	367
C ₃₉ H ₅₆ Cl ₂ P ₂ Ru	3-Phenyl-1H-inden-1-ylidene[bis(<i>i</i> -butylphoban)]ruthenium(II) dichloride	397
C ₃₉ H ₅₇ FeNO ₃ P ₂ PdS	Methanesulfonato(1,1'-bis(di- <i>t</i> -butylphosphino)ferrocene)(2'-amino-1,1'-biphenyl-2-yl)palladium(II), min. 98% [DTBPF Palladacycle Gen. 3]	240
C ₄₀ H ₂₆ N ₈	meso-Tetra(4-pyridyl)porphine, 97%	209
C ₄₀ H ₂₆ O ₂	(3R)-(-)-2,2'-Diphenyl-[3,3'-biphenanthrene]-4,4'-diol dichloromethane adduct, min. 98% (R)-VAPOL	219

Formula	Description	Page
C ₄₀ H ₃₁ ClN ₄ O ₅	(3S)-(+)-2,2'-Diphenyl-[3,3'-biphenanthrene]-4,4'-diol dichloromethane adduct, min. 98% (S)-VAPOL	219
C ₄₀ H ₃₂ Cl ₆ Cu ₂ N ₄	9-(2-Carboxyphenyl)-2-chloro-5-[[2-(di(2-pyridyl)aminomethyl)phenyl]aminomethyl]-6-hydroxy-3-xanthone Zinpry-4	190
C ₄₀ H ₃₂ O ₂ P ₂	μ -Benzenebis[N,N'-(1,3-dimethyl-1,3-propanediylidene)bis(2,6-dichlorobenzeneamino)]dicopper(I), benzene adduct, min. 98%	54
C ₄₀ H ₃₂ O ₄ P ₂	6,6'-Bis(diphenylphosphino)-1,1',3,3'-tetrahydro[5,5']bisobenzofuran, 99%	271
C ₄₀ H ₃₃ O ₄ P	R-(+)-6,6'-Bis(diphenylphosphino)-2,2',3,3'-tetrahydro-5'-bi-1,4-benzodioxin, min. 94% (R)-SYNPHOS™	271
C ₄₀ H ₃₃ O ₄ P	S-(-)-6,6'-Bis(diphenylphosphino)-2,2',3,3'-tetrahydro-5'-bi-1,4-benzodioxin, min. 97% (S)-SYNPHOS™ (11bR)-8,9,10,11,12,13,14,15-Octahydro-4-hydroxy-2,6-di- <i>n</i> -naphthalenyl-4-oxide-dinaphtho[2,1-d:1',2'-f][1,3,2]dioxaphosphepin, 98% (99% ee)	317
C ₄₀ H ₃₄ P ₂	(R)-(-)-4,12-Bis(diphenylphosphino)-[2,2]-paracyclophane, min. 95% (R)-PHANEPHOS	270
C ₄₀ H ₃₄ P ₂	(S)-(+)-4,12-Bis(diphenylphosphino)-[2,2]-paracyclophane, min. 95% (S)-PHANEPHOS	270
C ₄₀ H ₃₆ Cl ₂ FeN ₂ P ₂ Ru	Dichloro(1,1'-bis(diphenylphosphino)ferrocene)(2-aminomethylpyridine)ruthenium(II) RuCl ₂ (AMPY)(DPPF)	386
C ₄₀ H ₃₆ F ₆ N ₄ O ₆ S ₂	11,12-Bis[N-benzyl-1H-imidazolium-3-methylene]-9,10-dihydro-9,10-ethanoanthracene bis(trifluoromethanesulfonate)	180
C ₄₀ H ₃₆ OP ₂	2,2'-(Di- <i>o</i> -tolylphosphino)diphenylether, min. 97% DTP-DPEphos	311
C ₄₀ H ₃₆ O ₄ P ₂	(S)-2,2'-Bis(diphenylphosphino)-4,4',6,6'-tetramethoxy-1,1'-biphenyl, min. 97% (S)-PhGarphos™	272
C ₄₀ H ₃₆ O ₄ P ₂ Pd	(R)-2,2'-Bis(diphenylphosphino)-4,4',6,6'-tetramethoxy-1,1'-biphenyl, min. 97% (R)-PhGarphos™	272
C ₄₀ H ₃₆ O ₄ P ₂ Pd	Diacetabis(triphenylphosphine)palladium(II), 99%	235
C ₄₀ H ₄₀ F ₆ IrN ₄ P	(4,4'-Di- <i>t</i> -butyl-2,2'-bipyridine)bis[2-(2-pyridinyl-kN)phenyl-kC]iridium(III) hexafluorophosphate, 99%	90
C ₄₀ H ₄₀ F ₆ N ₄ O ₆ S ₂	11,12-Bis[N-(<i>i</i> -propyl)-1H-benzimidazolium-3-methylene]-9,10-dihydro-9,10-ethanoanthracene bis(trifluoromethanesulfonate)	188
C ₄₀ H ₄₀ F ₁₂ FeP ₂	(R)-(-)-1-[(S)-2-Bis(3,5-di-trifluoromethylphenyl)phosphino]ferrocenyl]ethylidicyclohexylphosphine, min. 97%	98
C ₄₀ H ₄₀ FeP ₂	(R)-(-)-1-[(S)-2-(Diphenylphosphino)ferrocenyl]ethylidicyclohexylphosphine, min. 97%	104
C ₄₀ H ₄₀ FeP ₂	1,1'-Bis(1-diphenylphosphino-1-methylethyl)ferrocene ethanol adduct, 97% HiersoPHOS-6 (SyPhos)	97
C ₄₀ H ₄₁ ClN ₂ Pd	Chloro(1- <i>t</i> -butylidene)[1,3-bis(2,6-di- <i>i</i> -propylphenyl)imidazol-2-yl]palladium(II), 98%	230
C ₄₀ H ₄₃ Cl ₂ N ₃ O ₂ P ₂ Ru	Dichloro[4(S,SR)-(-)-4,5-bis(diphenylphosphinomethyl)-2,2-dimethyl-1,3-dioxolane] [(S)-(-)-2-(α -methylmethanamine)-1H-benzimidazole]ruthenium(II), min. 95%	387
C ₄₀ H ₄₃ Cl ₂ N ₃ O ₂ P ₂ Ru	Dichloro[4(R,SR)-(-)-4,5-bis(diphenylphosphinomethyl)-2,2-dimethyl-1,3-dioxolane] [(R)-(+)-2-(α -methylmethanamine)-1H-benzimidazole]ruthenium(II), min. 95%	387
C ₄₀ H ₄₆ N ₄ O ₈	Coproporphyrin I tetramethyl ester, 98% (synthetic)	191
C ₄₀ H ₅₀ NO ₅ PPdS	Methanesulfonato(2-dicyclohexylphosphino-2',6'-dimethoxy-1,1'-biphenyl)(2'-methylamino-1,1'-biphenyl-2-yl)palladium(II) dichloromethane adduct, min. 98% [SPhos Palladacycle Gen. 4]	244
C ₄₀ H ₆₀ Cl ₄ Ru ₄	Chloro(pentamethylcyclopentadienyl)ruthenium(II) tetramer, min. 95%	379

Formula Index

Formula	Description	Page
C ₄₀ H ₈₄ O ₄ Si	Tetradecyloxysilane	410
C ₄₁ H ₃₀ F ₆ O ₃ P ₂ Ru	Carbonylbis(trifluoroacetato)bis(triphenylphosphine)ruthenium(II) methanol adduct, min. 98%	368
C ₄₁ H ₃₄ FeOP ₂	(S)-(-)-[(S)-2-Diphenylphosphinoferrocenyl][2-diphenylphosphinophenyl]methanol, min. 97%	103
C ₄₁ H ₃₄ P ₂	(R)-(+)-7,7'-Bis(diphenylphosphino)-2,2',3,3'-tetrahydro-1,1'-spirobiindane, min. 97% (R)-SDP	272
	(S)-(-)-7,7'-Bis(diphenylphosphino)-2,2',3,3'-tetrahydro-1,1'-spirobiindane, min. 97% (S)-SDP	272
C ₄₁ H ₃₅ ClFeNiP ₂	Chloro(2-methylphenyl)[1,1'-bis(diphenylphosphino)ferrocene]nickel (II), 98%	174
C ₄₁ H ₃₅ ClP ₂ Ru	Chloro(cyclopentadienyl)bis(triphenylphosphine)ruthenium(II), 99%	376
C ₄₁ H ₃₉ P ₃	1,1,1-Tris(diphenylphosphinomethyl)ethane, min. 97% TRIPHOS	331
C ₄₁ H ₄₂ NPS	(R)-(+)-7-[N-(2-Phenylthio)ethylamino]-7'-bis(3,5-dimethylphenyl)phosphino]-2,2',3,3'-tetrahydro-1,1'-spirobiindane, 97+% (>99% ee) [(R)-Xyl-SpiroSAP-Ph]	319
C ₄₁ H ₄₄ NO ₃ PPdS	Methanesulfonato(2-di-t-butylphosphino-1,1'-binaphthyl)(2'-amino-1,1'-biphenyl-2-yl)palladium(II), min. 95% [TrixiePhos Palladacycle Gen. 3]	242
C ₄₁ H ₄₆ N ₂ O ₂	(4S,4'S)-2,2'-(1,3-Bis[4-(t-butyl)phenyl]propane-2,2-diy)bis(4-phenyl-4,5-dihydroxazole) (S)-BTBBPh-SaBOX	181
C ₄₁ H ₄₆ ClN ₃ Pd	Chloro[2-[(1-(N-phenyl)iminoethyl)phenyl]{1,3-bis(2,6-di-i-propylphenyl)imidazole-2-ylidene}palladium(II)	234
C ₄₁ H ₅₀ O ₃ P ₂	(11aS)-1,2,10,11-Tetramethyl-4,8-bis(t-butyl)-6-[[2(S,5S)-(2,5-diphenyl-1-phospholanyl) methoxy]-dibenzol[d,f][1,3,2]dioxaphosphepin] S ₃ S ₃ -BOBPHOS	324
C ₄₁ H ₅₄ N ₃ O ₃ P PdS	Methanesulfonato(2-dicyclohexylphosphino-2',6'-bis(dimethylamino)-1,1'-biphenyl)(2'-amino-1,1'-biphenyl-2-yl)palladium(II), 98% [CPhos Palladacycle Gen. 3]	243
C ₄₁ H ₅₅ BF ₄ N ₄ Pd	[1,3-bis(2,6-di-i-propylphenyl)-4,5-dihydroimidazol-2-ylidene][2-[(dimethylamino-kN)methyl]phenyl-kC](pyridine)palladium(II) tetrafluoroborate, min. 97% PACCTM	228
C ₄₁ H ₅₉ CINPPd	Chloro(2-dicyclohexylphosphino-2',4',6'-tri-i-propyl-1,1'-biphenyl)[2-(2-aminoethyl)phenyl] palladium(II) methyl-t-butylether adduct, min. 98% [XPhos Palladacycle Gen. 1]	232
C ₄₂ H ₂₇ LaO ₅	Di-[(3)-(S)-2,2'-dihydroxy-1,1'-binaphthyl-methyl)]ether, lanthanum(III) salt, tetrahydrofuran adduct SCT-(S)-BINOL	111
C ₄₂ H ₃₄ F ₁₆ IrN ₄ P	(4,4'-Di-t-butyl-2,2'-bipyridine)bis[3,5-difluoro-2-[5-trifluoromethyl-2-pyridinyl-kN)phenyl-kC]iridium(III) hexafluorophosphate, 99%	90
C ₄₂ H ₃₄ O ₈ P ₂ Ru	Diacetato[(R)-(+)-5,5'-bis(diphenylphosphino)-4,4'-bi-1,3-benzodioxole]ruthenium(II) Ru(OAc) ₂ [(R)-segphos@]	380
	Diacetato[(S)-(-)-5,5'-bis(diphenylphosphino)-4,4'-bi-1,3-benzodioxole]ruthenium(II) Ru(OAc) ₂ [(S)-segphos@]	380
C ₄₂ H ₃₅ CINiP ₂	Chlorobis(triphenylphosphino)phenylnickel(II), 98%	173
C ₄₂ H ₃₉ BrF ₆ N	(11bR)-4,4-Dibutyl-2,6-bis(3,4,5-trifluorophenyl)-4,5-dihydro-3H-dinaphtho[2,1-c:1',2'-e]azepinium bromide	194
	(11bS)-4,4-Dibutyl-2,6-bis(3,4,5-trifluorophenyl)-4,5-dihydro-3H-dinaphtho[2,1-c:1',2'-e]azepinium bromide	194
C ₄₂ H ₃₆ FeP ₂	(R)-(+)-1-[(R)-2-(2-Diphenylphosphinophenyl)ferrocenyl]ethyl(diphenylphosphine), min. 97%	104
C ₄₂ H ₄₀ O ₂ P ₂	(R)-(+)-2,2'-Bis(di-p-tolylphosphino)-6,6'-dimethoxy-1,1'-biphenyl, min. 97%	275
	(S)-(-)-2,2'-Bis(di-p-tolylphosphino)-6,6'-dimethoxy-1,1'-biphenyl, min. 97%	275

Formula	Description	Page
C ₄₂ H ₄₂ Cl ₂ P ₂ Pd	trans-Dichlorobis(tri-o-tolylphosphine)palladium(II), min. 95%	239
C ₄₂ H ₄₂ N ₂₈ O ₁₄	Cucurbit[7]uril (CB7) hydrate, 99+%	192
C ₄₂ H ₄₂ P ₂ Pd	Bis(tri-o-tolylphosphine)palladium(0), min. 98%	229
C ₄₂ H ₄₂ P ₄	Tris[2-(diphenylphosphino)ethyl]phosphine, 98% PP ₃	331
C ₄₂ H ₄₇ Cl ₂ N ₃ O ₂ P ₂ Ru	Dichloro[(4S,5S)-(+)-4,5-bis(diphenylphosphinomethyl)-2,2-dimethyl-1,3-dioxolane][S(-)-2-(i-propyl)methanamine]-1H-benzimidazole]ruthenium(II), min. 95%	387
	Dichloro[(4R,5R)-(-)-4,5-bis(diphenylphosphinomethyl)-2,2-dimethyl-1,3-dioxolane][(R)-(+)-2-(i-propyl)methanamine]-1H-benzimidazole]ruthenium(II), min. 95%	387
C ₄₂ H ₄₈ BF ₄ P ₂ Rh	(-)-1,2-Bis[(2R,5R)-2,5-diphenylphospholano]ethane(1,5-cyclooctadiene)rhodium(I) tetrafluoroborate, min. 98% (R,R)-Ph-BPE-Rh	353
	(+)-1,2-Bis[(2S,5S)-2,5-diphenylphospholano]ethane(1,5-cyclooctadiene)rhodium(I) tetrafluoroborate, min. 98% (S,S)-Ph-BPE-Rh	353
C ₄₂ H ₄₈ FeP ₂	(R)-(-)-1-[(R)-2-(2'-Diphenylphosphinophenyl)ferrocenyl]ethyl(dicyclohexylphosphine), min. 97%	104
C ₄₂ H ₅₃ CINO ₂ P Pd	Chloro(2-dicyclohexylphosphino-2',6'-di-i-propoxy-1,1'-biphenyl)(2'-amino-1,1'-biphenyl-2-yl)palladium(II), min. 98%	232
	[RuPhos Palladacycle Gen. 2]	232
C ₄₂ H ₅₃ Fe ₂ NP ₂	1-[[{(R)-Ferrocenyl-2-(S)-ethyl-1-dimethylamino]phenyl-(R)-phosphino]-1'-dicyclohexylphosphinoferrocene, min. 97% Chenphos ...	106
	1-[[{(S)-Ferrocenyl-2-(R)-ethyl-1-dimethylamino]phenyl-(S)-phosphino]-1'-dicyclohexylphosphinoferrocene, min. 97% Chenphos ...	106
C ₄₂ H ₅₆ FeO ₂ P ₂	(R)-(-)-1-[(S)-2-[Bis(3,5-dimethyl-4-methoxyphenyl)phosphino]ferrocenyl]ethyl(dicyclohexylphosphine), min. 97%	97
C ₄₂ H ₅₈ NO ₃ PPdS	Methanesulfonato(2-di-t-butylphosphino-2',4',6'-tri-i-propyl-1,1'-biphenyl)(2'-amino-1,1'-biphenyl-2-yl)palladium(II), min. 98%	243
	[t-BuXPhos Palladacycle Gen. 3]	243
C ₄₂ H ₆₃ O ₃ P	Tris(2,4-di-t-butylphenyl)phosphite, 98%	331
C ₄₂ H ₆₇ O ₂ P	Trihexyl(tetradecyl)phosphonium decanoate, min. 95% CYPHOS@ IL 103	84
C ₄₃ H ₁₅ BF ₂₀	Trityltetra(pentafluorophenyl)borate, min. 97%	31
C ₄₃ H ₃₇ CINiP ₂	Bis(triphenylphosphino)(2-methylphenyl)chloronickel(II), 99%	173
C ₄₃ H ₃₉ FeNP ₂	(S)-(-)-[(S)-2-Diphenylphosphinoferrocenyl](N,N-dimethylamino) (2-diphenylphosphino)phenylmethane, min. 97% TANIAPHOS	103
	(R)-(+)-[(R)-2-Diphenylphosphinoferrocenyl](N,N-dimethylamino) (2-diphenylphosphino)phenylmethane, min. 97%	103
C ₄₃ H ₄₆ Cl ₄ N ₄ Ru	1,3-Bis(2,4,6-trimethylphenyl)-2-imidazolidinylidene(3-phenyl-1H-inden-1-ylidene)(4,5-dichloro-1,3-diethyl-1,3-dihydro-2H-imidazo-2-ylidene)ruthenium(II) chloride	367
C ₄₃ H ₄₈ ClFeN NiP ₂	Chloro(4-cyanophenyl)(R)-1-[(S)-2-(dicyclohexylphosphino)ferrocenyl]ethyl (diphenylphosphine)nickel(II)	173
C ₄₃ H ₄₈ Cl ₂ N ₃ O ₂ P ₂ Ru	Dichloro[(4S,5S)-(+)-4,5-bis(diphenylphosphinomethyl)-2,2-dimethyl-1,3-dioxolane][S(-)-2-(i-propyl)methanamine]-1H-benzimidazole]ruthenium(II), min. 95%	386
	Dichloro[(4S,5S)-(+)-4,5-bis(diphenylphosphinomethyl)-2,2-dimethyl-1,3-dioxolane][S(-)-2-(t-butyl)methanamine]-1H-benzimidazole]ruthenium(II), min. 97%	386
C ₄₃ H ₄₈ Cl ₂ N ₃ PRuS	Tricyclohexylphosphine[2,4-dihydro-2,4,5-triphenyl-3H-1,2,4-triazol-3-ylidene][2-thienyl(methylene)ruthenium(II) dichloride, min. 95% [catMETium® RF 4]	399

Formula Index

Formula	Description	Page	Formula	Description	Page
C ₄₃ H ₅₆ N ₂ O ₄ P PdS	Methanesulfonato[N-(2-(di-1-adamantylphosphino)phenyl)morpholine](2'-amino-1,1'-biphenyl-2-yl)palladium(II) dichloromethane adduct, min. 98% [Mor-Dalpos Palladacycle Gen. 3].....	241	C ₄₄ H ₃₈ O ₂ P ₂	(+)-1,13-Bis(diphenyl)phosphino-(5aR,8aR,14aR)-5a,6,7,8,8a,9-hexahydro-5H-[1]benzopyran [3,2-d]xantheno, 97% (R,R,R)-(+)-Ph-SKP.....	269
C ₄₃ H ₅₆ NO ₅ PPdS	Methanesulfonato(2-dicyclohexylphosphino-2',6'-di-i-propoxy-1,1'-biphenyl)(2'-amino-1,1'-biphenyl-2-yl)palladium(II), min. 98% [RuPhos Palladacycle Gen. 3].....	244	C ₄₄ H ₄₀ N ₂ O ₂ P ₂	(1R,2R)-(+)-1,2-Diaminocyclohexane-N,N'-bis(2'-diphenylphosphinobenzoyl), 98% (R,R)-DACH-Phenyl Trost Ligand.....	285
C ₄₃ H ₅₆ CoN ₂ O ₅ S	(1S,2S)-(+)-1,2-Cyclohexanediamino-N,N'-bis(3,5-di-t-butylsilylcalicidene) cobalt(III) p-toluenesulfonate monohydrate...	51	C ₄₄ H ₄₀ P ₂	(1S,2S)-(-)-1,2-Diaminocyclohexane-N,N'-bis(2'-diphenylphosphinobenzoyl), 95% (S,S)-DACH-Phenyl Trost Ligand.....	285
C ₄₃ H ₆₀ ClFeN NiP ₂	Chloro(4-cyanophenyl)((R)-1-[(S)-2-(dicyclohexylphosphino)ferrocenyl]ethyl (dicyclohexylphosphino))nickel(II).....	173	C ₄₄ H ₄₀ P ₂	(R)-(+)-2,2'-Bis(diphenylphosphino)-5,5',6,6',7,7',8,8'-octahydro-1,1'-binaphthyl (R)-(+)-H ₈ -BINAP.....	270
C ₄₃ H ₅₆ ClO ₂ PPd	Chloro(1-t-butylindanyl)[2-(dicyclohexylphosphino)-2',6'-di-i-propoxy-1,1'-biphenyl] palladium(II).....	230	C ₄₄ H ₄₀ P ₂	(S)-(-)-2,2'-Bis(diphenylphosphino)-5,5',6,6',7,7',8,8'-octahydro-1,1'-binaphthyl (S)-(-)-H ₈ -BINAP.....	270
C ₄₃ H ₆₀ NO ₃ PPdS	Methanesulfonato(2-di-t-butylphosphino-2',4',6'-tri-i-propyl-1,1'-biphenyl)(2'-methylamino-1,1'-biphenyl-2-yl)palladium(II) dichloromethane adduct, min. 98% [t-BuXphos Palladacycle Gen. 4].....	243	C ₄₄ H ₄₂ N ₂ P ₂	3,3'-Bis(diphenylphosphino)-5,5',6,6',7,7',8,8'-octahydro [2,2'] binaphthalene chloroform adduct, 99%.....	269
C ₄₃ H ₆₁ ClNiP ₂	Chlorobis(dicyclohexylphenylphosphino)(2-methylphenyl)nickel(II), 99%.....	173	C ₄₄ H ₄₂ N ₂ P ₂	(S)-(-)-2,2'-Bis(N-diphenylphosphinoamino)-5,5',6,6',7,7',8,8'-octahydro-1,1'-binaphthyl, min. 95% CTH-S-BINAM.....	266
C ₄₃ H ₆₁ O ₂ P	2-(Di-1-adamantylphosphino)-3,6-dimethoxy-2',4',6'-tri-i-propyl-1,1'-biphenyl, min. 95% AdBrettPhos.....	284	C ₄₄ H ₄₂ O ₄ P	(R)-4,12-Bis(4-methoxyphenyl)-[2,2]-paracyclophane R-An-Phanephos.....	278
C ₄₃ H ₆₃ ClNO ₂ P Pd	Chloro[2-(dicyclohexylphosphino)-3,6-dimethoxy-2',4',6'-tri-i-propyl-1,1'-biphenyl][2-(2-aminoethyl)phenyl]palladium(II), min. 98% [BrettPhos Palladacycle Gen. 1].....	231	C ₄₄ H ₄₄ Cl ₂ N ₂ P ₂ Ru	(S)-4,12-Bis(4-methoxyphenyl)-[2,2]-paracyclophane S-An-Phanephos.....	278
C ₄₃ H ₆₃ FeNP ₂	(S)-(-)-[(S)-2-Dicyclohexylphosphinoferrrocenyl](N,N-dimethylamino)(2-dicyclohexylphosphinophenyl)methane, min. 97%.....	101	C ₄₄ H ₄₄ Cl ₂ N ₂ P ₂ Ru	Dichloro[(1R,2R)-N,N-bis[2-(diphenylphosphino)benzyl]cyclohexane-1,2-diamine] ruthenium(II), min. 97%.....	382
C ₄₃ H ₆₃ FeNP ₂	(R)-(+)-[(R)-2-Dicyclohexylphosphinoferrrocenyl](N,N-dimethylamino)(2-dicyclohexylphosphinophenyl)methane, min. 97%.....	101	C ₄₄ H ₄₄ N ₂ P ₂	Dichloro[(1S,2S)-N,N-bis[2-(diphenylphosphino)benzyl]cyclohexane-1,2-diamine] ruthenium(II), min. 97%.....	382
C ₄₃ H ₇₂ Cl ₂ P ₂ RuS	Bis(tricyclohexylphosphine)[(phenylthio)methylene]ruthenium(II) dichloride, min. 97%.....	366	C ₄₄ H ₄₄ N ₂ P ₂	(1R,2R)-N,N-Bis[2-(diphenylphosphino)benzyl]cyclohexane-1,2-diamine, min. 97%..	266
C ₄₄ H ₂₆ N ₄ Na ₄ O ₁₂ S ₄	Tetrasodium-meso-tetra(4-sulfonatophenyl) porphine dodecahydrate, min. 95%.....	209	C ₄₄ H ₄₄ O ₄ P ₂	(S)-2,2'-Bis(di-p-tolylphosphino)-4,4',6,6'-tetramethoxy-1,1'-biphenyl, min. 97% (S)-TolGarphos™.....	275
C ₄₄ H ₂₆ ClCrN ₄	Chromium(III) tetraphenylporphine chloride.....	46	C ₄₄ H ₄₄ O ₄ P ₂	(R)-2,2'-Bis(di-p-tolylphosphino)-4,4',6,6'-tetramethoxy-1,1'-biphenyl, min. 97% (R)-TolGarphos™.....	275
C ₄₄ H ₂₆ ClFeN ₄	Iron(III) meso-tetraphenylporphine chloride.....	109	C ₄₄ H ₄₆ Fr ₆ Ir ₄ N ₄ P	4,4'-Bis(t-butyl)-2,2'-bipyridine[bis[5-methyl-2-(4-methyl-2-pyridinyl)-kN]phenyl-kC]iridium hexafluorophosphate, 95%.....	86
C ₄₄ H ₂₆ CoN ₄	Cobalt(II) meso-tetraphenylporphine.....	50	C ₄₄ H ₄₈ P ₂ S	(+)-[4-(1R,4S)-3-(Diphenylphosphino)-1,7,7-trimethylbicyclo[2.2.1]hept-2-en-2-yl]-2,5-dimethyl-3-thien-3-yl]bis(3,5-dimethylphenyl)phosphine, min. 95% [catASium® T3].....	309
C ₄₄ H ₂₆ MgN ₄	Magnesium meso-tetraphenylporphine hydrate.....	123	C ₄₄ H ₄₉ FeP ₃	4-(t-Butyl)-1,2-bis(diphenylphosphino)-1'-1'-(di-i-propylphosphino)ferrocene, 98% HiersoPHOS-4.....	99
C ₄₄ H ₂₈ N ₄ Ni	Nickel(II) meso-tetraphenylporphine.....	175	C ₄₄ H ₅₇ N ₂ O ₄ P PdS	Methanesulfonato[N-(2-(di-1-adamantylphosphino)phenyl)morpholine](2'-methylamino-1,1'-biphenyl-2-yl)palladium(II) dichloromethane adduct, min. 98% MorDalpos Palladacycle Gen. 4.....	241
C ₄₄ H ₂₈ N ₄ OV	Vanadyl meso-tetraphenylporphine.....	446	C ₄₄ H ₅₈ NO ₅ PPdS	Methanesulfonato(2-dicyclohexylphosphino-2',6'-di-i-propoxy-1,1'-biphenyl)(2'-methylamino-1,1'-biphenyl-2-yl)palladium(II), min. 98% [RuPhos Palladacycle Gen. 4].....	245
C ₄₄ H ₂₈ N ₄ Zn	Zinc meso-tetraphenylporphine.....	453	C ₄₄ H ₆₁ Cl ₂ N ₂ P RuS	Tricyclohexylphosphine[1,3-bis(2,4,6-trimethylphenyl)imidazol-2-ylidene][2-thienyl(methylene)ruthenium(II) dichloride, min. 95% [catMETium® RF 2].....	399
C ₄₄ H ₃₀ N ₄	meso-Tetraphenylporphine, min. 97% TPP (contains 1-3% chlorin).....	209	C ₄₄ H ₆₂ NO ₄ PPdS	Methanesulfonato(2-(di-t-butylphosphino)-3-methoxy-6-methyl-2',4',6'-tri-i-propyl-1,1'-biphenyl)(2'-amino-1,1'-biphenyl-2-yl)palladium(II), min. 98% [RockPhos Palladacycle Gen. 3].....	242
C ₄₄ H ₃₀ N ₄	meso-Tetraphenylporphine TPP (chlorin free).....	209			
C ₄₄ H ₃₂ Cl ₂ Ir ₂ N ₄	Di-μ-chlorotetrakis[2-(2-pyridinyl-kN)phenyl-kC]diridium(III), 99%.....	91			
C ₄₄ H ₃₂ Cl ₂ P ₂ Pd	Dichloro[(R)-(+)-2,2'-bis(diphenylphosphino)-1,1'-binaphthyl]palladium(II), min. 98%... 237	237			
C ₄₄ H ₃₂ Cl ₂ P ₂ Pd	Dichloro[(S)-(-)-2,2'-bis(diphenylphosphino)-1,1'-binaphthyl]palladium(II), min. 98%... 237	237			
C ₄₄ H ₃₂ Cl ₂ P ₂ Ru	Dichloro[(R)-(+)-2,2'-bis(diphenylphosphino)-1,1'-binaphthyl]ruthenium(II), min. 95% . 386	386			
C ₄₄ H ₃₂ Cl ₂ P ₂ Ru	Dichloro[(S)-(-)-2,2'-bis(diphenylphosphino)-1,1'-binaphthyl]ruthenium(II), min. 95% .. racemic-2,2'-Bis(diphenylphosphino)-1,1'-binaphthyl, 98% rac-BINAP.....	386			
C ₄₄ H ₃₂ P ₂	(R)-(+)-2,2'-Bis(diphenylphosphino)-1,1'-binaphthyl, 98% (R)-(+)-BINAP.....	267			
C ₄₄ H ₃₂ P ₂	(S)-(-)-2,2'-Bis(diphenylphosphino)-1,1'-binaphthyl, 98% (S)-(-)-BINAP.....	267			
C ₄₄ H ₃₄ Cl ₂ N ₂ O ₅	9-(2-Carboxyphenyl)-2,7-dichloro-4,5-bis[(2-picolyl)(pyrazin-2-ylmethyl)aminomethyl]-6-hydroxy-3-xanthone ZPP1.....	190			
C ₄₄ H ₃₆ F ₁₂ FeP ₂	(R)-(-)-1-[(S)-2-[Bis(3,5-di-trifluoromethylphenyl)phosphino]ferrocenyl]ethyl-di-3,5-xylylphosphine, min. 97%.....	98			

Formula Index

Formula	Description	Page
C ₄₄ H ₆₂ NO ₅ PPdS	Methanesulfonato(2-(di-t-butylphosphino)-3,6-dimethoxy-2',4',6'-tri- <i>i</i> -propyl-1,1'-biphenyl)(2'-amino-1,1'-biphenyl-2-yl) palladium(II), dichloromethane adduct, min. 98%[t-BuBrettPhos Palladacycle Gen. 3].....	242
C ₄₄ H ₆₉ NP ₂	Bis[2-(di-1-adamantylphosphino)ethyl]amine, min. 97%.....	256
C ₄₄ H ₇₆ CeO ₈	Tetrakis(2,2,6,6-tetramethyl-3,5-heptanedionato)cerium(IV), min. 97% (99.9%-Ce) (REO) [Ce(TMHD)].....	42
C ₄₄ H ₇₆ HfO ₈	Tetrakis(2,2,6,6-tetramethyl-3,5-heptanedionato)hafnium(IV), 99%.....	78
C ₄₄ H ₇₆ NbO ₈	Tetrakis(2,2,6,6-tetramethyl-3,5-heptanedionato)niobium(IV), 99% [Nb(TMHD)].....	177
C ₄₄ H ₇₆ O ₈ Zr	Tetrakis(2,2,6,6-tetramethyl-3,5-heptanedionato) zirconium(IV), 99% [Zr(TMHD)].....	457
C ₄₄ H ₈₅ O ₃ PS	Tributyl(tetradecyl)phosphonium dodecylbenzenesulfonate, min. 98% CYPHOS® IL 201.....	83
C ₄₅ H ₈ F ₂₀ N ₄ ORu	Carbonyl[5,10,15,20-tetrakis(2,3,4,5,6-pentafluorophenyl)-21H,23H-porphinato] ruthenium(II), min. 98%.....	369
C ₄₅ H ₃₁ O ₄ P	3,7-di-9-phenanthrenyl-5-oxide-diindenol[7,1-de:1',7'-fg][1,3,2]dioxaphosphocin, min. 98% (11aS)-10,11,12,13-Tetrahydro-5-hydroxy-3,7-di-9-phenanthrenyl-5-oxide-diindenol[7,1-de:1',7'-fg][1,3,2]dioxaphosphocin, min. 98% (R)-(+)-4-Dimethylaminopyridinyl(pentaphenylcyclopentadienyl)iron, min. 98% (R)-C ₆ H ₅ -DMAP.....	322
C ₄₅ H ₃₆ FeN ₂	Chloro(indenyl)bis(triphenylphosphine) ruthenium(II), dichloromethane adduct, min. 98%.....	378
C ₄₅ H ₃₇ CIP ₂ Ru	Chloro(hydrotris(pyrazol-1-yl)borato) bis(triphenylphosphine)ruthenium(II) ethanol adduct.....	378
C ₄₅ H ₄₂ P ₂	(R)-(+)-7,7'-Bis[di(4-methylphenyl)phosphino]-2,2',3,3'-tetrahydro-1,1'-spirobiindane, min. 97% (R)-Tol-SDP.....	264
C ₄₅ H ₄₉ O ₄ P	(S)-(-)-7,7'-Bis[di(4-methylphenyl)phosphino]-2,2',3,3'-tetrahydro-1,1'-spirobiindane, min. 97% (S)-Tol-SDP.....	265
C ₄₅ H ₅₁ Cl ₂ N ₂ O ₃ PRu	Tri(<i>i</i> -propoxy)phosphine(3-phenyl-1H-inden-1-ylidene)[1,3-bis(2,4,6-trimethylphenyl)-4,5-dihydroimidazol-2-ylidene]ruthenium (II) dichloride, min. 95% cis-Caz-1.....	400
C ₄₅ H ₅₉ CINPPd	Chloro(2-dicyclohexylphosphino-2',4',6'-tri- <i>i</i> -propyl-1,1'-biphenyl)(2'-amino-1,1'-biphenyl-2-yl) palladium(II), min. 98% [XPhos Palladacycle Gen. 2].....	232
C ₄₅ H ₆₅ FeNO ₃ P ₂	Methanesulfonato((R)-(-)-1-[(S)-2(dicyclohexylphosphino)ferrocenyl]thyl-di-t-butylphosphine)(2'-amino-1,1'-biphenyl-2-yl)palladium(II), min. 98% [Josiphos Palladacycle Gen. 3].....	245
C ₄₅ H ₇₁ Cl ₃ N ₄ O ₃ Ru	(1,3-Bis(2,6-diisopropylphenyl)-4-(4-ethyl-4-methylpiperazin-1-ium-1-yl)methyl)imidazolidin-2-ylidene(2-isopropoxybenzylidene) ruthenium(II) chloride dihydrate FixCat.....	365
C ₄₅ H ₇₂ CuF ₃ O ₅ P ₄ S	Bis[1-(2R,5R)-2,5-diethylphospholanyl]-[2-(2R,5R)-2,5-diethylphospholanyl-1-oxide] benzene)copper(I) trifluoromethanesulfonate, min. 97%.....	54
C ₄₅ H ₇₂ CuF ₃ O ₅ P ₄ S	Bis[1-(2S,5S)-2,5-diethylphospholanyl]-[2-(2S,5S)-2,5-diethylphospholanyl-1-oxide] benzene)copper(I) trifluoromethanesulfonate, min. 97%.....	54
C ₄₆ H ₃₁ MnN ₄ O ₂	Manganese(III) meso-tetraphenylporphine acetate.....	127
C ₄₆ H ₃₂ F ₁₂ FeP ₂	(R)-(-)-1-[(R)-2-(2'-Diphenylphosphinophenyl)ferrocenyl]ethylbis(di-3,5-trifluoromethylphenyl)phosphine, min. 97%.....	104

Formula	Description	Page
C ₄₆ H ₃₆ Cl ₂ N ₆ O ₅	9-(2-Carboxyphenyl)-2,7-dichloro-4,5-bis(di(2-pyridyl)aminomethyl)-6-hydroxy-3-xanthanone ZINPYR-1.....	191
C ₄₆ H ₃₆ N ₄ O ₁₁	2-(4,5-Bis[(6-(2-ethoxy-2-oxohydroxy)-2-methylquinolin-8-ylamino)methyl]-6-hydroxy-3-oxo-3H-xanthen-9-yl)benzoic acid FL2A.....	185
C ₄₆ H ₃₈ BrF ₁₂ P	(11bS)-(-)-4,4-Dibutyl-2,6-bis[3,5-bis(trifluoromethyl)phenyl]-4,5-dihydro-3H-dinaphtho[2,1-c:1'-2'-e]phosphine bromide, 99% S-MARUOKA CAT P-NB.....	286
C ₄₆ H ₃₈ BrF ₁₂ P	(11bR)-(+)-4,4-Dibutyl-2,6-bis[3,5-bis(trifluoromethyl)phenyl]-4,5-dihydro-3H-dinaphtho[2,1-c:1'-2'-e]phosphine bromide, 99% R-MARUOKA CAT P-NB.....	286
C ₄₆ H ₃₈ BrF ₁₂ P	(11bS)-(-)-4,4-Di-t-butyl-2,6-bis[3,5-bis(trifluoromethyl)phenyl]-4,5-dihydro-3H-dinaphtho[2,1-c:1'-2'-e]phosphine bromide, 99% R-MARUOKA CAT P-TB.....	286
C ₄₆ H ₃₈ Cl ₂ FeNO	(-)-Dichloro[(4S)-4-(<i>i</i> -propyl)-2-((S)-2-(diphenylphosphino)ferrocenyl)oxazoline] (triphenylphosphine)ruthenium(II).....	392
C ₄₆ H ₃₈ Cl ₂ FeNO	(+)-Dichloro[(4R)-4-(<i>i</i> -propyl)-2-(di-phenylphosphino)ferrocenyl)oxazoline] (triphenylphosphine)ruthenium(II).....	392
C ₄₆ H ₄₄ F ₁₂ FeP ₂	(R)-(+)-1-[(R)-2-(2'-Dicyclohexylphosphino)phenyl]ferrocenyl]ethylbis(3,5-trifluoromethylphenyl)phosphine, min. 97%.....	102
C ₄₆ H ₄₄ FeP ₂	(R)-(+)-1-[(R)-2-(2'-Diphenylphosphinophenyl)ferrocenyl]ethyl(di(3,5-xylyl)phosphine), min. 97%.....	105
C ₄₆ H ₄₄ O ₄ P ₂	(R)-(+)-5,5'-Bis[di(3,5-xylyl)phosphino]-4,4'-bi-1,3-benzodioxole, min. 98% (R)-(+)-DM-SEGPHOS®.....	276
C ₄₆ H ₄₄ O ₄ P ₂	(S)-(-)-5,5'-Bis[di(3,5-xylyl)phosphino]-4,4'-bi-1,3-benzodioxole, min. 98% (S)-(-)-DM-SEGPHOS®.....	276
C ₄₆ H ₄₄ O ₈ P ₂	6,6'-[(3,3'-Di- <i>t</i> -butyl-5,5'-dimethoxy-1,1'-biphenyl-2,2'-diyl)bis(oxy)] bis(dibenzo[d,f][1,3,2]dioxaphosphino) hemi ethyl acetate adduct, min. 95% BIPHEPHOS.....	287
C ₄₆ H ₄₆ CIP ₂ Ru	Chloro(pentamethylcyclopentadienyl)bis(triphenylphosphine)ruthenium(II), 99%.....	379
C ₄₆ H ₄₆ BF ₄ N ₂ O ₄ P ₂ Rh	(R)-(+)-2,2',6,6'-Tetramethoxy-4,4'-bis(diphenylphosphino)-3,3'-bipyridine(1,5-cyclooctadiene)rhodium(II) tetrafluoroborate, min. 97%.....	360
C ₄₆ H ₄₆ BF ₄ N ₂ O ₄ P ₂ Rh	(S)-(-)-2,2',6,6'-Tetramethoxy-4,4'-bis(diphenylphosphino)-3,3'-bipyridine(1,5-cyclooctadiene)rhodium(I) tetrafluoroborate, min. 97%.....	360
C ₄₆ H ₄₆ B ₂ O ₉	3',6'-Bis[4-(4,4,5,5-tetramethyl-1,3,2-dioxaborolan-2-yl)oxy]-3H- <i>is</i> piro(isobenzofuran-1,9-xanthen-3-one) FBBSB.....	25
C ₄₆ H ₄₆ O ₄ P ₂ Pd ₂	trans-Di(μ -acetato)bis[<i>o</i> -(di- <i>o</i> -tolylphosphino)benzyl]dipalladium(II), 97+% [cataCXium® C].....	235
C ₄₆ H ₄₈ O ₂ P ₂	(R)-(+)-2,2'-Bis[di(3,5-xylyl)phosphino]-6,6'-dimethoxy-1,1'-biphenyl, min. 97% .. (S)-(-)-2,2'-Bis[di(3,5-xylyl)phosphino]-6,6'-dimethoxy-1,1'-biphenyl, min. 97% ..	277
C ₄₆ H ₄₈ O ₁₀ P ₂	(R)-(+)-2,2'-Bis[di(3,5-dimethoxyphenyl)phosphino]-6,6'-dimethoxy-1,1'-biphenyl, 98% (R)-ECNU-Phos.....	260
C ₄₆ H ₅₀ N ₂ O ₄ P ₂	(R)-(+)-2,2',6,6'-Tetramethoxy-4,4'-bis(di(3,5-xylyl)phosphino)-3,3'-bipyridine, min. 97% CTH-(R)-Xylyl-P-PHOS.....	324
C ₄₆ H ₅₀ N ₂ O ₄ P ₂	(S)-(-)-2,2',6,6'-Tetramethoxy-4,4'-bis(di(3,5-xylyl)phosphino)-3,3'-bipyridine, min. 95% CTH-(S)-Xylyl-P-Phos.....	324
C ₄₆ H ₆₁ MoNO ₂	2,6-Diisopropylphenylimidoneophylidene[racemic-BIPHEN]molybdenum(VI), min. 97% rac-SCHROCK-HOVEYDA CATALYST.....	137

Formula Index

Formula	Description	Page	Formula	Description	Page
	2,6-Diisopropylphenylimidoneophylidene [(R)-(+)-BIPHEN]molybdenum(VI), min. 97% (R) SCHROCK-HOVEYDA CATALYST	137	C ₄₈ H ₃₆ BF ₂₄ Ir	Bis(1,5-cyclooctadiene)iridium(I) tetrakis[3,5-bis(trifluoromethyl)phenyl]borate, 98%	86
	2,6-Diisopropylphenylimidoneophylidene[(S)-(-)-BIPHEN]molybdenum(VI), min. 97% (S) SCHROCK-HOVEYDA CATALYST	137	C ₄₈ H ₃₆ CoN ₄ O ₄	Cobalt(II) meso-tetra(4-methoxyphenyl) porphine, min. 96%	50
C ₄₆ H ₆₆ NO ₃ PPdS	Methanesulfonato(2-dicyclohexylphosphino-2',4',6'-tri- <i>i</i> -propyl-1,1'-biphenyl)(2'-amino-1,1'-biphenyl-2-yl)palladium(II) dichloromethane adduct, min. 98% [Xphos Palladacycle Gen. 3]	245	C ₄₈ H ₃₈ CuN ₂ O ₂ P ₂	(1,10-Phenanthroline)bis(triphenylphosphine)copper(I) nitrate dichloromethane adduct, 98%	59
C ₄₈ H ₆₄ CIPpd	Chloro(1- <i>t</i> -butylindenyl)[2-(dicyclohexylphosphino)-2',4',6'-tri- <i>i</i> -propyl-1,1'-biphenyl]palladium(II)	230	C ₄₈ H ₃₈ O ₄ P ₂ Ru	Diacetato((R)-(+)-2,2'-bis(diphenylphosphino)-1,1'-binaphthyl)ruthenium(II) Ru(OAc) ₂ [(R)-binap]	380
C ₄₆ H ₆₂ CIN ₂ OP Ru	[1,3-Bis(2,4,6-trimethylphenylimidazolidin-2-ylidene)](tricyclohexylphosphine)-(2-oxobenzylidene)ruthenium(II) chloride LatMet	368	C ₄₈ H ₄₀ P ₂	(R)-(+)-2,2'-Bis(di- <i>p</i> -tolylphosphino)-1,1'-binaphthyl, 98% (R)-(+)-TolBINAP	275
C ₄₆ H ₆₂ Cl ₂ N ₂ P RuS	Tricyclohexylphosphine[1,3-bis(2,4,6-trimethylphenyl)-4,5-dihydroimidazol-2-ylidene] [(phenylthio)methylene]ruthenium(II) dichloride	399	C ₄₈ H ₄₁ NP ₂	Bis(2-[1(1bR)-3,5-dihydro-4H-dinaphtho[2,1-c:1',2'-e]phosphepin-4-yl]ethyl)amine, min. 97%	262
	Tricyclohexylphosphine[4,5-dimethyl-1,3-bis(2,4,6-trimethylphenyl)imidazol-2-ylidene][2-thienylmethylene]ruthenium(II) dichloride, min. 95% [catMETium® RF 3]	400	C ₄₈ H ₄₂ Cl ₂ O ₄ P ₂ Ru	Chloro((R)-(+)-5,5'-bis(diphenylphosphino)-4,4'-bi-1,3-benzodioxole)(<i>p</i> -cymene)ruthenium(II) chloride [RuCl(<i>p</i> -cymene) ((R)-segphos®)]Cl	371
C ₄₆ H ₆₆ NO ₃ PPdS	Methanesulfonato(2-di- <i>t</i> -butylphosphino-3,4,5,6-tetramethyl-2',4',6'-tri- <i>i</i> -propylbiphenyl)(2'-amino-1,1'-biphenyl-2-yl)palladium(II), min. 95% [Me4 <i>t</i> -ButylXPhos Palladacycle Gen. 3]	243		Chloro((S)-(-)-5,5'-bis(diphenylphosphino)-4,4'-bi-1,3-benzodioxole)(<i>p</i> -cymene)ruthenium(II) chloride [RuCl(<i>p</i> -cymene) ((S)-segphos®)]Cl	372
C ₄₇ H ₃₆ Cl ₂ O ₄ Ti	(4R,5R)-(-)-2,2-Dimethyl- α,α,α' -tetra(1-naphthyl)-1,3-dioxolane-4,5-dimethanolatotitanium(IV) dichloride acetonitrile adduct	440	C ₄₈ H ₄₄ Cl ₄ O ₂ P ₂ Ru	Chloro((R)-(+)-5,5'-dichloro-6,6'-dimethoxy-2,2'-bis(diphenylphosphino)-1,1'-biphenyl)(<i>p</i> -cymene)ruthenium(II) chloride CH ₂ Cl ₂ adduct	377
C ₄₇ H ₃₈ O ₄	(4R,5R)-(-)-2,2-Dimethyl- α,α,α' -tetra(1-naphthyl)-1,3-dioxolane-4,5-dimethanol, min. 97% (R,R)-1-Nph-TADDOL	218	C ₄₈ H ₄₄ FeP ₂	(R)-(-)-1-[(S)-2-(Di-1-naphthylphosphino)ferrocenyl]ethylidene-3,5-xylylphosphine, min. 97%	102
C ₄₇ H ₄₀ F ₆ FeOP ₂	(S)-(-)-[(S)-2-Di(3,5-xylyl)phosphinoferrocenyl][2-di(4-trifluoromethylphenyl)phosphino]phenylmethanol, min. 97%	105	C ₄₈ H ₄₄ O ₈ P ₂	Tetramethyl 6,6'-bis(diphenylphosphino)-1,1',3,3'-tetrahydro[5,5']biindene-2,2',2,2'-tetracarboxylate, 99%	324
C ₄₇ H ₄₁ FeNO ₃ P ₂ PdS	Methanesulfonato[1,1'-bis(diphenylphosphino)ferrocene][(2'-amino-1,1'-biphenyl-2-yl)palladium(II), min. 98% [DPPP Palladacycle Gen. 3]	240	C ₄₈ H ₄₆ BF ₄ P ₂ Rh	(R)-(-)-4,12-Bis(diphenylphosphino)[2,2]paracyclophane(1,5-cyclooctadiene)rhodium(I) tetrafluoroborate, min. 97%	353
C ₄₇ H ₄₆ O ₂ P ₂	racemic-8,8'-Bis(diphenylphosphino)-3,3',4,4'-tetrahydro-4,4',4',6',6'-hexamethyl-2,2'-spiro[12H-1-benzopyran], min. 95% SPANphos	272	C ₄₈ H ₄₆ O ₂ P ₂	(+)-1,13-Bis(di(4-methylphenyl)phosphino)-[5aR,8aR,14aR]-5a,6,7,8,9a-hexahydro-5H-[1]benzopyrano[3,2- <i>d</i>]xanthene, 97% (R,R,R)-(+)-Tol-SKP	264
C ₄₇ H ₄₇ FeO ₃ P ₂	(S)-(-)-[(S)-2-Diphenylphosphinoferrocenyl][2-bis(3,5-dimethyl-4-methoxyphenyl)phosphinophenyl]methanol, min. 97%	103	C ₄₈ H ₄₆ O ₂ P ₂ Ru	Diacetato((R)-(+)-2,2'-bis(diphenylphosphino)-5,5,6,6',7,7',8,8'-octahydro-1,1'-binaphthyl)ruthenium(II) Ru(OAc) ₂ [(R)-H ₈ -binap]	380
C ₄₇ H ₅₁ F ₆ IrN ₂ P ₂	Triphenylphosphine(1,5-cyclooctadiene)[1,3-bis(2,4,6-trimethylphenyl)imidazol-2-ylidene]iridium(I) hexafluorophosphate, min. 98%	93		Diacetato((S)-(-)-2,2'-bis(diphenylphosphino)-5,5,6,6',7,7',8,8'-octahydro-1,1'-binaphthyl)ruthenium(II) Ru(OAc) ₂ [(S)-H ₈ -binap]	380
C ₄₇ H ₅₃ CINO ₂ P Pd	Chloro(2-dicyclohexylphosphino-3,6-dimethoxy-2',4',6'-tri- <i>i</i> -propyl-1,1'-biphenyl)(2'-amino-1,1'-biphenyl-2-yl)palladium(II), min. 98% [BrettPhos Palladacycle Gen. 2]	231	C ₄₈ H ₄₇ FeP	1,2,3,4,5-Pentaphenyl-1'-(di- <i>t</i> -butylphosphino)ferrocene, 95% CTC-Q-PHOS	110
C ₄₇ H ₆₄ NO ₃ PPdS	Methanesulfonato(2-dicyclohexylphosphino-2',4',6'-tri- <i>i</i> -propyl-1,1'-biphenyl)(2'-methylamino-1,1'-biphenyl-2-yl)palladium(II), min. 98% [XPhos Palladacycle Gen. 4]	245	C ₄₈ H ₄₈ N ₂ O ₁₆	Cucurbit[8]uril (CB[8]) hydrate, 99%+	192
C ₄₈ H ₂₀ Cl ₂ F ₂₀ Ir ₂ N ₄	Di- μ -chlorotetrakis[3,5-difluoro-2-[5-trifluoromethyl-2-pyridinyl-kN]phenyl-kC]diiridium(III), 99%	90	C ₄₈ H ₅₀ P ₂	(R)-(-)-4,12-Bis(di(3,5-xylyl)phosphino)-[2,2]paracyclophane, min. 97% CTH-(R)-3,5-xylyl-PHANEPHOS	272
C ₄₈ H ₂₈ F ₂₄ O ₄ P ₂	(S)-2,2'-Bis[bis(3,5-trifluoromethylphenyl)phosphino]-4,4',6,6'-tetramethoxy-1,1'-biphenyl, min. 97% (S)-BTfM-Garphos™	255	C ₄₈ H ₅₂ N ₂ P ₂	(S)-(+)-4,12-Bis(di(3,5-xylyl)phosphino)-[2,2]paracyclophane, min. 97% CTH-(S)-3,5-xylyl-PHANEPHOS	277
	(R)-2,2'-Bis[bis(3,5-trifluoromethylphenyl)phosphino]-4,4',6,6'-tetramethoxy-1,1'-biphenyl, min. 97% (R)-BTfM-Garphos™	255	C ₄₈ H ₅₂ O ₄ P ₂	(1R,2R)-N,N-Bis[2-(di- <i>p</i> -tolylphosphino)benzyl]cyclohexane-1,2-diamine, min. 97%	274
C ₄₈ H ₂₆ O ₃₂ Zr ₆	Zirconium 1,4-dicarboxybenzene MOF (UiO-66)	457		(1S,2S)-N,N-Bis[2-(di- <i>p</i> -tolylphosphino)benzyl]cyclohexane-1,2-diamine, min. 97%	274
C ₄₈ H ₃₀ N ₄ O ₈	meso-Tetra(4-carboxyphenyl)porphine, 98%	209	C ₄₈ H ₅₂ O ₄ P ₂	(S)-2,2'-Bis[bis(3,5-dimethylphenyl)phosphino]-4,4',6,6'-tetramethoxy-1,1'-biphenyl, min. 97% (S)-Xyl-Garphos™	253

Formula Index

Formula	Description	Page
	(R)-2,2'-Bis[bis(3,5-dimethylphenyl)phosphino]-4,4',6,6'-tetramethoxy-1,1'-biphenyl, min. 97% (R)-Xyl-Garphos™	253
C ₄₈ H ₅₄ N ₄ O ₁₆	Uroporphyrin I, octamethyl ester	212
C ₄₈ H ₅₇ FeP ₃	Uroporphyrin III, octamethyl ester	213
	1',4-Bis-(t-butyl)-1,2-bis(diphenylphosphino)-3'-(di-i-propylphosphino)ferrocene, 98% HiersoPHOS-1	94
C ₄₈ H ₆₆ NO ₅ PPdS	Methanesulfonato(2-dicyclohexylphosphino-3,6-dimethoxy-2',4',6'-tri-i-propyl-1,1'-biphenyl)(2'-amino-1,1'-biphenyl-2-yl)palladium(II), min. 98% [BrettPhos Palladacycle Gen. 3]	244
C ₄₈ H ₁₀₂ O ₂ P ₂	Trihexyl(tetradecyl)phosphonium bis(2,4,4-trimethylpentyl)phosphinate, min. 95% CYPHOS@ IL 104	83
C ₄₉ H ₃₅ IrN ₂ O ₆ P ₂	[(S)-(-)-5,5'-Bis(diphenylphosphino)-4,4'-bi-1,3-benzodioxole][4-cyano-3-nitrobenzenecarboxylato][1,2,3-η-2-propenyl]iridium(III), min. 98%	86
	[(R)-(+)-5,5'-Bis(diphenylphosphino)-4,4'-bi-1,3-benzodioxole][4-cyano-3-nitrobenzenecarboxylato][1,2,3-η-2-propenyl]iridium(III), min. 97%	86
C ₄₉ H ₄₀ N ₂ O ₄ P ₂ PdS	Methanesulfonato[4,6-bis(diphenylphosphino)phenoxazine](2'-amino-1,1'-biphenyl-2-yl)palladium(II), 98% [NiXantphos Palladacycle Gen. 3]	240
C ₄₉ H ₄₆ Cl ₂ O ₂ P ₂ Ru	Chloro((R)-(-)-1,13-bis(diphenylphosphino)-7,8-dihydro-6H-dibenzo[h,h']1,5]dioxonin)(p-cymene)ruthenium(II) chloride (R)-C ₂ -TUNEPHOS-Ru	374
C ₄₉ H ₅₀ FeOP ₂	(S)-(-)-[(S)-2-Di(3,5-xylyl)phosphinoferrocenyl][2-di(3,5-xylyl)phosphinophenyl]methanol, min. 97%	105
C ₄₉ H ₅₀ P ₂	(R)-(+)-7,7'-Bis[di(3,5-dimethylphenyl)phosphino]-2,2',3,3'-tetrahydro-1,1'-spirobiindane, min. 97% (R)-Xyl-SDP	261
	(S)-(-)-7,7'-Bis[di(3,5-dimethylphenyl)phosphino]-2,2',3,3'-tetrahydro-1,1'-spirobiindane, min. 97% (S)-Xyl-SDP	261
C ₄₉ H ₅₂ F ₆ N ₃ P ₃ Ru	Acetonitrilebis[2-diphenylphosphino-6-t-butylpyridine]cyclopentadienylruthenium(II) hexafluorophosphate, min. 98%	363
C ₄₉ H ₆₆ O ₁₀ P ₂	(+)-6,6'-[[(1R,3R)-1,3-Dimethyl-1,3-propanediyl]bis(oxy)]bis[4,8-bis-(t-butyl)-2,10-dimethoxy-benzo[d,f][1,3,2]dioxaphosphepin], min. 95% (R,R)-Chiraphite	299
	(-)-6,6'-[[(1S,3S)-1,3-Dimethyl-1,3-propanediyl]bis(oxy)]bis[4,8-bis-(t-butyl)-2,10-dimethoxy-benzo[d,f][1,3,2]dioxaphosphepin], min. 95% (S,S)-Chiraphite	299
C ₄₉ H ₆₈ NO ₅ PPdS	Methanesulfonato(2-dicyclohexylphosphino-3,6-dimethoxy-2',4',6'-tri-i-propyl-1,1'-biphenyl)(2'-methylamino-1,1'-biphenyl-2-yl)palladium(II), min. 98% [BrettPhos Palladacycle Gen. 4]	244
C ₅₀ H ₄₄ F ₆ N ₄ O ₆ S ₂	11,12-Bis[(N-(2-methylbenzyl)-1H-benzimidazolium-3-methylene)-9,10-dihydro-9,10-ethanoanthracene bis(trifluoromethanesulfonate)], min. 95%	186
C ₅₀ H ₄₄ N ₄ O ₁₁	2-(4,5-Bis[(6-(2-ethoxy-2-oxoethoxy)-2-methylquinolin-8-ylamino)methyl]-6-hydroxy-3-oxo-3H-xanthen-9-yl)benzoic acid FL2E	184
C ₅₀ H ₄₄ O ₂ P ₂	(2R,2'R,3R,3'R)-4,4'-Di(anthracen-9-yl)-3,3'-di-t-butyl-2,2',3,3'-tetrahydro-2,2'-bibenzo[d][1,3]oxaphosphole, min 98% (>90% ee), [(2R,2'R,3R,3'R)-WingPhos]	285
	(2S,2'S,3S,3'S)-4,4'-Di(anthracen-9-yl)-3,3'-di-t-butyl-2,2',3,3'-tetrahydro-2,2'-bibenzo[d][1,3]oxaphosphole, min 98%, (>99% ee), [(2S,2'S,3S,3'S)-WingPhos]	285
C ₅₀ H ₄₆ BClF ₄ N ₂ P ₂ Ru	Chloro[(R)-2,2'-bis(diphenylphosphino)-1,1'-binaphthyl][(1R,2R)-cyclohexane-1,2-diamine]ruthenium(II) tetrafluoroborate, min. 97%	372

Formula	Description	Page
	Chloro[(S)-2,2'-bis(diphenylphosphino)-1,1'-binaphthyl][(1S,2S)-cyclohexane-1,2-diamine]ruthenium(II) tetrafluoroborate, min. 97%	372
C ₅₀ H ₄₇ CIN ₄ O ₃ Ru	[1,3-Bis(2,4,6-trimethylphenyl)-2-imidazolidinylidene]-[2-[[[4-methylphenyl]imino]methyl]-4-nitrophenyl]-[3-phenyl-1H-inden-1-ylidene]ruthenium(II) chloride	367
C ₅₀ H ₄₈ CIN ₃ ORu	[1,3-Bis(2,4,6-trimethylphenyl)-2-imidazolidinylidene]-[2-[[[2-methylphenyl]imino]methyl]phenyl]-[3-phenyl-1H-inden-1-ylidene]ruthenium(II) chloride	367
C ₅₀ H ₅₀ O ₆ P ₂ Ru	Diacetato((R)-(+)-5,5'-bis[di(3,5-xylyl)phosphino]-4,4'-bi-1,3-benzodioxole)ruthenium(II) Ru(OAc) ₂ ((R)-dm-segphos@)	381
	Diacetato((S)-(-)-5,5'-bis[di(3,5-xylyl)phosphino]-4,4'-bi-1,3-benzodioxole)ruthenium(II) Ru(OAc) ₂ ((S)-dm-segphos@)	381
C ₅₀ H ₅₂ FeP ₂	(R)-(+)-1-[(R)-2-(2'-Di-3,5-xylylphosphino-phenyl)ferrocenyl]ethyl-di-3,5-xylylphosphine, min. 97%	105
C ₅₀ H ₅₄ Fe ₃ N ₂ P ₂	1,1'-Bis[1-[(S)-ferrocenyl-2-(R)-ethyl-1-(dimethylamino)phenyl](R)-phosphino]ferrocene, min. 97% Trifer	98
	1,1'-Bis[1-[(R)-ferrocenyl-2-(S)-ethyl-1-(dimethylamino)phenyl](R)-phosphino]ferrocene, min. 97% Trifer	98
C ₅₀ H ₅₆ O ₁₄ P ₂	(R)-(+)-2,2'-Bis[di(3,4,5-trimethoxyphenyl)phosphino]-6,6'-dimethoxy-1,1'-biphenyl, min. 97%	276
	(S)-(-)-2,2'-Bis[di(3,4,5-trimethoxyphenyl)phosphino]-6,6'-dimethoxy-1,1'-biphenyl, min. 97%	276
C ₅₀ H ₅₇ F ₆ IrN ₂ P ₂	Tribenzylphosphine(1,5-cyclooctadiene) [1,3-bis(2,4,6-trimethylphenyl)imidazol-2-ylidene]iridium(I) hexafluorophosphate, min. 98%	93
C ₅₀ H ₆₆ O ₄ P	(S)-3,3'-Bis2,4,6-trisopropylphenyl-5',6',6',7',7',8',8'-octahydro-1,1'-binaphthyl-2,2'-diyl Hydrogenphosphate, 98%, (99% ee)	281
	(R)-3,3'-Bis2,4,6-trisopropylphenyl-5',6',6',7',7',8',8'-octahydro-1,1'-binaphthyl-2,2'-diyl Hydrogenphosphate, 98%, (99% ee)	281
C ₅₀ H ₆₈ NPS ₂	(R)-(+)-7-[N-(1,3-Dithian-2-yl)methylamino]-7'-[bis(3,5-di-t-butylphenyl)phosphino]-2,2',3,3'-tetrahydro-1,1'-spirobiindane, 97+% (>99% ee) [(R)-DTB-SpiroSAP]	311
	(S)-(-)-7-[N-(1,3-Dithian-2-yl)methylamino]-7'-[bis(3,5-di-t-butylphenyl)phosphino]-2,2',3,3'-tetrahydro-1,1'-spirobiindane, 97+% (>99% ee) [(R)-DTB-SpiroSAP]	311
C ₅₀ H ₆₈ ClIrNPS ₂	((R)-(+)-7-[N-(1,3-Dithian-2-yl)methylamino]-7'-[bis(3,5-di-t-butylphenyl)phosphino]-2,2',3,3'-tetrahydro-1,1'-spirobiindane)chlorohydroiridium(III), 97+% [(R)-DTB-SpiroSAP]	91
	((S)-(-)-7-[N-(1,3-Dithian-2-yl)methylamino]-7'-[bis(3,5-di-t-butylphenyl)phosphino]-2,2',3,3'-tetrahydro-1,1'-spirobiindane)chlorohydroiridium(III), 97+% [(R)-DTB-SpiroSAP]	91
C ₅₁ H ₃₆ NO ₂ P ₂	(S)-2-(1-Naphthyl)-8-diphenylphosphino-1-[[R]-3,5-dioxa-4-phospha-cyclohepta[2,1-a;3,4-a']dinaphthalen-4-yl]-1,2-dihydroquinoline toluene adduct, min. 92%	316
C ₅₁ H ₄₁ ClP ₂ Ru	Chloro(1-phenylindeny)bis(triphenylphosphine)ruthenium(II), min. 98%	379
C ₅₁ H ₄₂ CINOP ₂ Pd	Chloro[9,9-dimethyl-4,5-bis(diphenylphosphino)xanthene][2'-amino-1,1'-biphenyl]palladium(II) dichloromethane adduct, min. 98% [Xantphos Palladacycle Gen. 2]	233
C ₅₁ H ₄₂ O ₃ Pd ₂	Tris(dibenzylideneacetone)dipalladium(0)	249
C ₅₁ H ₄₂ O ₃ Pd ₂ / C ₁₂ H ₂₈ BF ₄ P	Tris(dibenzylideneacetone)dipalladium(0)/tri-t-butylphosphonium tetrafluoroborate admixture (molar Pd/P = 1:1.2)	249

Formula Index

Formula	Description	Page	Formula	Description	Page
	Tris(dibenzylideneacetone)dipalladium(0)/tri- <i>t</i> -butylphosphonium tetrafluoroborate admixture (molar Pd/P = 1:2).....	249		(S)-4,12-Bis(4-methoxyphenyl)[2.2]-paracyclophane(1,5-cyclooctadiene)rhodium(I) tetrafluoroborate, min. 97%.....	355
C ₅₁ H ₄₂ O ₃ Pt	Tris(dibenzylideneacetone)platinum(0), min. 98%.....	340	C ₅₂ H ₅₄ O ₂ P ₂	(+)-1,13-Bis[di(3,5-dimethylphenyl)phosphino]-(5 <i>a</i> R,8 <i>a</i> R,14 <i>a</i> R)-5 <i>a</i> ,6,7,8,8 <i>a</i> ,9-hexahydro-5H-[1]benzopyrano[3,2- <i>d</i>]xanthene, 97% (R,R,2R)-(+)-Xyl-SKP.....	260
C ₅₁ H ₄₂ O ₃ Pt ₂	Tris(dibenzylideneacetone)diplatinum(0), min. 98%.....	340		(-)-1,13-Bis[di(3,5-dimethylphenyl)phosphino]-(5 <i>a</i> S,8 <i>a</i> S,14 <i>a</i> S)-5 <i>a</i> ,6,7,8,8 <i>a</i> ,9-hexahydro-5H-[1]benzopyrano[3,2- <i>d</i>]xanthene, 97% (S,S,S)-(-)-Xyl-SKP.....	261
C ₅₁ H ₅₂ BN ₆ P ₂ Rh	[Tris(3,5-dimethyl-1 <i>H</i> -pyrazolato)hydroborato]bis(triphenylphosphine)rhodium(I) toluene adduct, 99%.....	361	C ₅₂ H ₆₀ N ₂ P ₂	(1 <i>R</i> ,2 <i>R</i>)- <i>N</i> , <i>N</i> -Bis[2-bis(3,5-dimethylphenyl)phosphino]benzyl]cyclohexane-1,2-diamine, min. 97%.....	252
C ₅₁ H ₆₂ N ₂ O ₂	(3 <i>a</i> S,3 <i>a</i> 'S,8 <i>a</i> R,8 <i>a</i> 'R)-2,2'-(1,3-Bis(3,5-di- <i>t</i> -butylphenyl)propane-2,2-diyl)bis(8,8 <i>a</i> -dihydro-3 <i>a</i> H-indeno[1,2- <i>d</i>]oxazole) (S,R)-BDTBI <i>n</i> -SaBOX.....	182		(1 <i>S</i> ,2 <i>S</i>)- <i>N</i> , <i>N</i> -Bis[2-bis(3,5-dimethylphenyl)phosphino]benzyl]cyclohexane-1,2-diamine, min. 97%.....	252
C ₅₁ H ₆₃ N ₂ P	(R)-(+)-7-Bis(3,5-di- <i>t</i> -butylphenyl)phosphino-7-[(pyridine-2-ylmethyl)amino]-2,2',3,3'-tetrahydro-1,1'-spiroindane, min. 98% (>99% ee) (R)-DTB-SpiroPAP.....	257	C ₅₂ H ₆₀ O ₈ P ₂	(S)-2,2'-Bis[bis(4-methoxy-3,5-dimethylphenyl)phosphino]-4,4',6,6'-tetramethoxy)-1,1'-biphenyl, min. 97% (S)-DMM-Garphos™.....	254
	(R)-(+)-7-Bis(3,5-di- <i>t</i> -butylphenyl)phosphino-7-[(pyridine-2-ylmethyl)amino]-2,2',3,3'-tetrahydro-1,1'-spiroindane, min. 98% (>99% ee) (S)-DTB-SpiroPAP.....	257		(R)-2,2'-Bis[bis(4-methoxy-3,5-dimethylphenyl)phosphino]-4,4',6,6'-tetramethoxy)-1,1'-biphenyl, min. 97% (R)-DMM-Garphos™.....	254
C ₅₁ H ₇₆ Cl ₂ P ₂ Ru	Bis(tricyclohexylphosphine)-3-phenyl-1 <i>H</i> -inden-1-ylideneruthenium(II) dichloride.....	366	C ₅₂ H ₆₂ N ₂ P	(R)-(+)-7-Bis(3,5-di- <i>t</i> -butylphenyl)phosphino-7-[(3-methylpyridine-2-ylmethyl)amino]-2,2',3,3'-tetrahydro-1,1'-spiroindane, min. 98% (>99% ee) (R)-DTB-SpiroPAP-6-Me.....	257
C ₅₂ H ₄₂ Cl ₃ O ₃ Pd ₂	Tris(dibenzylideneacetone)dipalladium(0) chloroform adduct.....	249		(R)-(+)-7-Bis(3,5-di- <i>t</i> -butylphenyl)phosphino-7-[(3-methylpyridine-2-ylmethyl)amino]-2,2',3,3'-tetrahydro-1,1'-spiroindane, min. 98% (>99% ee) (R)-DTB-SpiroPAP-3-Me.....	256
C ₅₂ H ₄₄ F ₁₂ FeO ₂ P ₂	(R)-(+)-1-[(R)-2-[2'-Bis(3,5-dimethyl-4-methoxyphenyl)phosphino]ferrocenyl]ethylbis(di-3,5-trifluoromethylphenyl)phosphine, min. 97%.....	97		(S)-(-)-7-Bis(3,5-di- <i>t</i> -butylphenyl)phosphino-7-[(3-methylpyridine-2-ylmethyl)amino]-2,2',3,3'-tetrahydro-1,1'-spiroindane, min. 98% (>99% ee) (S)-DTB-SpiroPAP-3-Me.....	257
C ₅₂ H ₄₄ N ₂ O ₂ P ₂	(1 <i>R</i> ,2 <i>R</i>)-(+)-1,2-Diaminocyclohexane- <i>N</i> , <i>N</i> '-bis(2-diphenylphosphino-1-naphthyl), min. 94% (R,R)-DACH-Naphthyl Trost Ligand.....	285	C ₅₂ H ₆₇ ClIrN ₂ P	Chlorodihydrido((R)-(+)-7-Bis(3,5-di- <i>t</i> -butylphenyl)phosphino-7-[(3-methylpyridine-2-ylmethyl)amino]-2,2',3,3'-tetrahydro-1,1'-spiroindane)iridium(III), >97% (>99% ee) Ir-(R)-DTB-SpiroPAP-3-Me.....	87
	(1 <i>S</i> ,2 <i>S</i>)-(-)-1,2-Diaminocyclohexane- <i>N</i> , <i>N</i> '-bis(2-diphenylphosphino-1-naphthyl), min. 94% (S,S)-DACH-Naphthyl Trost Ligand.....	285		Chlorodihydrido((S)-(-)-7-Bis(3,5-di- <i>t</i> -butylphenyl)phosphino-7-[(3-methylpyridine-2-ylmethyl)amino]-2,2',3,3'-tetrahydro-1,1'-spiroindane)iridium(III), >97% (>99% ee) Ir-(R)-DTB-SpiroPAP-3-Me.....	87
C ₅₂ H ₄₅ NO ₄ P ₂	Methanesulfonato[9,9-dimethyl-4,5-bis(diphenylphosphino)xanthene][2'-amino-1,1'-biphenyl]palladium(II) dichloromethane adduct, min. 98% [Xantphos Palladacycle Gen. 3].....	246	C ₅₂ H ₆₇ F ₄ OP	2-(Diadamantylphosphino)-3-methoxy-2',4',6'-tri- <i>n</i> -propyl-3-(2,3,5,6-tetrafluoro-4-butylphenyl)-1,1'-biphenyl AlPhos.....	284
C ₅₂ H ₄₆ O ₄ P ₂ Ru	Diacetato((R)-(+)-2,2'-bis(di- <i>p</i> -tolylphosphino)-1,1'-binaphthyl]ruthenium(II) Ru(OAc) ₂ [(R)-tolbinap].....	381		2-Methyl-3-[polyisobutyl(12)]propanol (50% in heptane/polyisobutylene).....	96
	Diacetato((S)-(-)-2,2'-bis(di- <i>p</i> -tolylphosphino)-1,1'-binaphthyl]ruthenium(II) Ru(OAc) ₂ [(S)-tolbinap].....	381	C ₅₂ H ₇₄ FeN ₂ P ₂	(S,S)-(+)-2,2'-Bis[(R)- <i>N</i> , <i>N</i> -dimethylamino]phenyl)methyl]-1,1'-bis(dicyclohexylphosphino)ferrocene, min. 97%.....	96
C ₅₂ H ₄₈ P ₂	(R)-(+)-2,2'-Bis[di(3,5-xylyl)phosphino]-1,1'-binaphthyl, 98% (R)-(+)-XylBINAP.....	276		2-Methyl-3-[polyisobutyl(12)]propanol (50% in heptane/polyisobutylene).....	39
	(S)-(-)-2,2'-Bis[di(3,5-xylyl)phosphino]-1,1'-binaphthyl, 98% (S)-(-)-XylBINAP.....	276	C ₅₃ H ₄₃ Cl ₂ N ₃ P ₂ Ru	Dichloro((S)-(-)-2,2'-bis(diphenylphosphino)-1,1'-binaphthyl)[(S)-(-)-2-(α -methylmethanamine)-1 <i>H</i> -benzimidazole]ruthenium(II), min. 95%.....	385
	(3 <i>S</i> ,3' <i>S</i> ,4 <i>S</i> ,4' <i>S</i> ,11 <i>b</i> S,11 <i>b</i> 'S)-(+)-4,4'-Di- <i>t</i> -butyl-4,4',5,5'-tetrahydro-3,3'-bi-3 <i>H</i> -dinaphtho[2,1- <i>c</i> :1',2'- <i>e</i>]phosphepin, 97% (S)-BINAPINE.....	290		Dichloro((R)-(+)-2,2'-bis(diphenylphosphino)-1,1'-binaphthyl)[(S)-(+)-2-(α -methylmethanamine)-1 <i>H</i> -benzimidazole]ruthenium(II), min. 95%.....	385
C ₅₂ H ₄₈ P ₄ Pd	Bis[1,2-bis(diphenylphosphino)ethane]palladium(0), 98%.....	227	C ₅₃ H ₄₇ NO ₄ P ₂ PdS	Methanesulfonato[9,9-dimethyl-4,5-bis(diphenylphosphino)xanthene][2'-methylamino-1,1'-biphenyl-2-yl]palladium(II), 98% [Xantphos Palladacycle Gen. 4].....	246
C ₅₂ H ₅₀ Cl ₂ N ₄ O ₄ P ₂ Ru	Dichloro((R)-(+)-2,2',6,6'-tetramethoxy-4,4'-bis(diphenylphosphino)-3,3'-bipyridine)[(1 <i>R</i> ,2 <i>R</i>)-(+)-1,2-diphenylethylenediamine]ruthenium(II), min. 95%.....	393	C ₅₃ H ₅₈ O ₈ P ₂	Methyl α -D-glucopyranoside-2,6-dibenzoate-3,4-di(bis(3,5-dimethylphenyl)phosphinite), min. 95% CARBOPHO.....	316
	Dichloro((S)-(-)-2,2',6,6'-tetramethoxy-4,4'-bis(diphenylphosphino)-3,3'-bipyridine)[(1 <i>S</i> ,2 <i>S</i>)-(-)-1,2-diphenylethylenediamine]ruthenium(II), min. 95%.....	393	C ₅₃ H ₆₅ O ₄ P	(3 <i>a</i> R,8 <i>a</i> R)-(-)-4,4,8,8-Tetrakis(3,5-diethylphenyl)tetrahydro-2,2-dimethyl-6-phenyl-1,3-dioxolo[4,5- <i>e</i>]dioxaphosphepin.....	322
C ₅₂ H ₅₀ F ₁₂ NO ₅ P	Methanesulfonato[2-bis(3,5-di(trifluoromethyl)phenylphosphino)-3,6-dimethoxy-2',4',6'-tri- <i>n</i> -propyl-1,1'-biphenyl] (2'-amino-1,1'-biphenyl-2-yl)palladium(II), min. 98% [JackiePhos Palladacycle Gen. 3].....	241		(3 <i>a</i> S,8 <i>a</i> S)-(+)-4,4,8,8-Tetrakis(3,5-diethylphenyl)tetrahydro-2,2-dimethyl-6-phenyl-1,3-dioxolo[4,5- <i>e</i>]dioxaphosphepin.....	323
C ₅₂ H ₅₀ FeN ₂ P ₂	(S,S)-(-)-2,2'-Bis[(R)- <i>N</i> , <i>N</i> -dimethylamino]phenyl)methyl]-1,1'-bis(diphenylphosphino)ferrocene, min. 97%.....	96			
C ₅₂ H ₅₄ BF ₄ O ₄ P ₂ Rh	(R)-4,12-Bis(4-methoxyphenyl)[2.2]-paracyclophane(1,5-cyclooctadiene)rhodium(I) tetrafluoroborate, min. 97%.....	355			

Formula Index

Formula	Description	Page	Formula	Description	Page
C ₅₃ H ₆₈ NPS	(R)-(+)-7-[N-(2-Phenylthio)ethylamino]-7'-bis(3,5-di- <i>t</i> -butylphenyl)phosphino]-2,2',3,3'-tetrahydro-1,1'-spirobiindane, 97+% (>99% ee) (R)-DTB-SpiroSAP-PH].....	319	C ₅₅ H ₄₇ OP ₃ Ru	Carbonyl(dihydro)tris(triphenylphosphine) ruthenium (II), 99%.....	369
C ₅₄ H ₄₀ FeP ₂	1,1'-Bis((S)-4,5-dihydro-3H-binaphtho[1,2-c:2',1'-e]phosphino)ferrocene, min. 98% (S,S)-f-Binaphane.....	96	C ₅₅ H ₆₆ NOP	(S)-(-)-7-[4(S)-Benzyl]oxazol-2-yl]-7-di(3,5-di- <i>t</i> -butylphenyl)phosphino-2,2',3,3'-tetrahydro-1,1'-spirobiindane, min. 97% (Sa,S)-DTB-Bn-SiPHOX.....	252
C ₅₄ H ₄₅ Au ₃ BF ₄ OP ₃	Tris(triphenylphosphine)gold(III)oxonium tetrafluoroborate, 98%.....	76	C ₅₄ H ₄₆ ClCoP ₃	(R)-(+)-7-[4(S)-Benzyl]oxazol-2-yl]-7-di(3,5-di- <i>t</i> -butylphenyl)phosphino-2,2',3,3'-tetrahydro-1,1'-spirobiindane, min. 97% (Ra,S)-DTB-Bn-SiPHOX.....	251
C ₅₄ H ₄₆ BrP ₃ Rh	Bromotris(triphenylphosphine)rhodium(I), 99% (99.9%-Rh).....	355	C ₅₅ H ₇₁ N ₂ P	(R)-(+)-7-Bis(3,5-di- <i>t</i> -butylphenyl)phosphino-7'-[(4- <i>t</i> -butylpyridine-2-ylmethyl)amino]-2,2',3,3'-tetrahydro-1,1'-spirobiindane, min. 98% (>99% ee) (R)-DTB-SpiroPAP-4-t-Bu.....	256
C ₅₄ H ₄₆ ClCoP ₃	Chlorotris(triphenylphosphine)cobalt(II), min. 98%.....	48	C ₅₆ H ₄₀ P ₂	12,12'-Bis(diphenylphosphino)-9,9',10,10'-tetrahydro-11,11'-bi-9,10-ethenoanthracene, min. 98% CATHPOS.....	271
C ₅₄ H ₄₆ ClP ₃ Rh	Chlorotris(triphenylphosphine)rhodium(I), 99% WILKINSON'S CATALYST.....	357	C ₅₆ H ₄₁ O ₄ PSi ₂	(R)-(-)-3,3'-Bis(triphenylsilyl)-1,1'-binaphthyl-2,2'-diyl hydrogen phosphate, min. 98% [(R)-TIPSY].....	281
C ₅₄ H ₄₆ Cl ₂ P ₃ Ru	Dichlorotris(triphenylphosphine)ruthenium(II), 99%.....	393	(S)-(+)-3,3'-Bis(triphenylsilyl)-1,1'-binaphthyl-2,2'-diyl hydrogen phosphate, min. 98% [(S)-TIPSY].....	281	
C ₅₄ H ₄₆ Cl ₂ P ₂ Ru	Chlorohydridotris(triphenylphosphine)ruthenium(II) toluene adduct, 98%.....	378	C ₅₆ H ₄₈ Cl ₂ N ₃ P ₂ Ru	Dichloro[(S)-(-)-2,2'-bis(diphenylphosphino)-1,1'-binaphthyl][(S)-binap]Cl.....	388
C ₅₄ H ₄₆ Cl ₂ P ₂ Ru	Chloro[(R)-(+)-2,2'-bis(diphenylphosphino)-1,1'-binaphthyl][(p-cymene)ruthenium(II) chloride [RuCl(p-cymene)](R)-binap]Cl.....	373	C ₅₆ H ₅₂ Cl ₂ N ₄ P ₂ Ru	Dichloro[5,10,15,20-tetrakis(2,4,6-trimethylphenyl)-21H,23H-porphinato]ruthenium(IV), min. 98%.....	392
C ₅₄ H ₄₆ Cl ₂ N ₂ P ₂ Ru	Dichloro[(R)-(+)-2,2'-bis(di- <i>p</i> -tolylphosphino)-1,1'-binaphthyl][(2-aminomethylpyridine)ruthenium(II) RuCl ₂ (AMPY)](R)-Tol-Binap].....	387	C ₅₆ H ₅₄ O ₄ P ₂ Ru	Diacetato[(R)-(+)-2,2'-bis(di(3,5-xylyl)phosphino)-1,1'-binaphthyl]ruthenium(II) Ru(OAc) ₂ [(R)-xylinap].....	381
C ₅₄ H ₄₆ Cl ₂ N ₂ P ₂ Ru	Dichloro[(S)-(-)-2,2'-bis(di- <i>p</i> -tolylphosphino)-1,1'-binaphthyl][(2-aminomethylpyridine)ruthenium(II) RuCl ₂ (AMPY)](S)-Tol-Binap].....	388	C ₅₆ H ₅₈ ClO ₄ P ₂ Ru	Diacetato[(S)-(-)-2,2'-bis(di(3,5-xylyl)phosphino)-1,1'-binaphthyl]ruthenium(II) Ru(OAc) ₂ [(S)-xylinap].....	381
C ₅₄ H ₅₃ FeP ₃	1',4-Bis(<i>t</i> -butyl)-1,2,3'-tris(diphenylphosphino)ferrocene, 98% HiersoPHOS-2.....	94	C ₅₆ H ₅₈ ClO ₄ P ₂ Ru	Chloro[(R)-(+)-5,5'-bis(di(3,5-xylyl)phosphino)-4,4'-bi-1,3-benzodioxole](p-cymene)ruthenium(II) chloride [RuCl(p-cymene)](R)-dm-seghos®]Cl.....	375
C ₅₄ H ₅₄ Cl ₂ P ₂ Ru	Chloro[(R)-(+)-2,2'-bis(diphenylphosphino)-5,5',6,6',7,7',8,8'-octahydro-1,1'-binaphthyl](p-cymene)ruthenium(II) chloride [RuCl(p-cymene)](R)-H ₂ -binap]Cl.....	374	C ₅₆ H ₅₈ Cl ₂ O ₄ P ₂ Ru	Chloro[(S)-(-)-5,5'-bis(di(3,5-xylyl)phosphino)-4,4'-bi-1,3-benzodioxole](p-cymene)ruthenium(II) chloride [RuCl(p-cymene)](S)-dm-seghos®]Cl.....	375
C ₅₄ H ₅₄ Cl ₂ P ₂ Ru	Chloro[(S)-(-)-2,2'-bis(diphenylphosphino)-5,5',6,6',7,7',8,8'-octahydro-1,1'-binaphthyl](p-cymene)ruthenium(II) chloride [RuCl(p-cymene)](S)-H ₂ -binap]Cl.....	374	C ₅₆ H ₅₈ FeN ₂ P ₂	(R,R)-(+)-2,2'-Bis[(S)-(N,N-dimethylamino)phenyl]methyl]-1,1'-bis(di(2-methylphenyl)phosphino)ferrocene, min. 97%.....	96
C ₅₄ H ₆₇ Cl ₂ N ₂ PRu	Tricyclohexylphosphine[1,3-bis(2,4,6-trimethylphenyl)imidazol-2-ylidene][3-phenyl-1H-inden-1-ylidene]ruthenium(II) dichloride, min. 95% [catMETium® RF1].....	399	C ₅₆ H ₆₂ BF ₄ P ₂ Rh	(R)-(-)-4,12-Bis(di-3,5-xylylphosphino)[2.2]paracyclophane(1,5-cyclooctadiene)rhodium(I) tetrafluoroborate, min. 97%.....	354
C ₅₄ H ₆₈ NPS	(R)-(+)-7-[N-(2-Benzylthio)ethylamino]-7'-bis(3,5-di- <i>t</i> -butylphenyl)phosphino]-2,2',3,3'-tetrahydro-1,1'-spirobiindane, 97+% (>99% ee) [(R)-DTB-SpiroSAP-Bn].....	252	C ₅₆ H ₇₂ F ₆ IrN ₄ P ₂	(S)-(+)-4,12-Bis(di-3,5-xylylphosphino)[2.2]paracyclophane(1,5-cyclooctadiene)rhodium(I) tetrafluoroborate, min. 97%.....	355
C ₅₄ H ₆₉ Cl ₂ N ₂ PRu	Tricyclohexylphosphine[3-phenyl-1H-inden-1-ylidene][1,3-bis(2,4,6-trimethylphenyl)-4,5-dihydroimidazol-2-ylidene]ruthenium(II) dichloride, min. 95%.....	400	C ₅₆ H ₇₄ NO ₅ PPdS	(4,4'-Di- <i>t</i> -butyl-2,2'-bipyridine)[bis(5-(<i>t</i> -butyl)-2-[4-(<i>t</i> -butyl)-2-pyridinyl-kN]phenyl-kC)iridium(III) hexafluorophosphate, 95%.....	90
C ₅₄ H ₇₂ Cl ₄ N ₄ Pd ₂	Dichloro(di- μ -chloro)bis[1,3-bis(2,6-di- <i>i</i> -propylphenyl)imidazol-2-ylidene]dipalladium(II), 97%.....	239	C ₅₆ H ₇₄ NO ₅ PPdS	Methanesulfonato[2-(di-1-adamantylphosphino)-3,6-dimethoxy-2',4',6'-tri- <i>i</i> -propyl-1,1'-biphenyl][2'-amino-1,1'-biphenyl-2-yl]palladium(II), min. 98% [AdBrettPhos Palladacycle Gen. 3].....	241
C ₅₄ H ₇₂ F ₁₂ N ₆ RuP ₂	Tris[4,4'-bis(<i>t</i> -butyl)-2,2'-bipyridine]ruthenium(II) hexafluorophosphate, 95%.....	401	C ₅₆ H ₁₀₇ N	4-[Polyisobutyl(12)]-2-ethylamine (50% in heptane/polyisobutylene).....	206
C ₅₄ H ₇₂ N ₄ P ₂	1,2-Bis[1,3-bis(2,6-di- <i>i</i> -propylphenyl)imidazol-2-ylidene]diphosphine, min. 95%.....	253	C ₅₇ H ₄₈ NO ₃ P ₂	Methanesulfonato[2,2'-bis(diphenylphosphino)-1,1'-binaphthyl][2'-amino-1,1'-biphenyl-2-yl]palladium(II), min. 98% [BINAP Palladacycle Gen. 3].....	240
C ₅₄ H ₇₂ N ₄ Si ₂	1,2-Bis[1,3-bis(2,6-di- <i>i</i> -propylphenyl)imidazol-2-ylidene]disilene.....	405	C ₅₇ H ₅₁ Cl ₂ N ₃ P ₂ Ru	Dichloro[(S)-(-)-2,2'-bis(di- <i>p</i> -tolylphosphino)-1,1'-binaphthyl][(S)-(-)-2-(α -methylmethanamine)-1H-benzimidazole]ruthenium(II), min. 95%.....	388
C ₅₄ H ₇₃ Au ₂ BF ₄ N ₄ O	Bis[1,3-bis[2,6-bis(1-methylethyl)phenyl]-1,3-dihydro-2H-imidazol-2-ylidene]- μ -hydroxydigold(I) tetrafluoroborate, 99%.....	72			
C ₅₄ H ₁₀₅ AlO ₆	Aluminum stearate.....	3			
C ₅₄ H ₁₀₅ CeO ₆	Cerium(III) stearate, tech. gr.....	42			
C ₅₅ H ₄₅ CuF ₃ P ₃	Tris(triphenylphosphine)(trifluoromethyl)copper(I), 99%.....	59			
C ₅₅ H ₄₆ ClOP ₃ Ru	Carbonylchlorohydridotris(triphenylphosphine)ruthenium(II), 99%.....	369			
C ₅₅ H ₄₆ IrOP ₃	Hydridocarbonyltris(triphenylphosphine)iridium(I), 99%.....	91			
C ₅₅ H ₄₆ OP ₃ Rh	Hydridocarbonyltris(triphenylphosphine)rhodium(I), 98%.....	358			
C ₅₅ H ₄₇ Cl ₂ N ₃ P ₂ Ru	Dichloro[(S)-(-)-2,2'-bis(diphenylphosphino)-1,1'-binaphthyl][(S)-(-)-2-(α -methylmethanamine)-1H-benzimidazole]ruthenium(II), min. 95%.....	386			

Formula Index

Formula	Description	Page	Formula	Description	Page
	Dichloro[(R)-(+)-2,2'-bis(di-p-tolylphosphino)-1,1'-binaphthyl][(R)-(+)-2-(α -methylmethanamine)-1H-benzimidazole]ruthenium(II), min. 95%.....	388	$C_{60}H_{66}FeN_2P_2$	(R,R)-(+)-2,2'-Bis[(S)-(N,N-dimethylamino)(phenyl)methyl]-1,1'-bis(di(3,5-dimethylphenyl)phosphino)ferrocene, min. 97%.....	96
$C_{57}H_{52}N_4ORu$	Carbonyl[5,10,15,20-tetrakis(2,4,6-trimethylphenyl)-21H,23H-porphinato]ruthenium(II), min. 98%.....	370	$C_{60}H_{66}Br_3N_4NiO_{12}P_8$	Bis(P,P'-1,5-diphenyl-3,7-bis[(4-hydrogenphosphonate)phenyl]-1,5,3,7-diazadiphosphocine)nickel(II) bromide (hydrogen bromide adduct).....	172
$C_{55}H_{46}BClF_4N_3Ru$	Chloro[(R)-2,2'-bis(diphenylphosphino)-1,1'-binaphthyl][2-(diphenylphosphino)ethanamine]ruthenium(II) tetrafluoroborate, min. 97%.....	374	$C_{61}H_{61}O_4P$	(3aR,8aR)-(-)-4,4,8,8-Tetrakis(3,5-di- <i>i</i> -propylphenyl)tetrahydro-2,2-dimethyl-6-phenyl-1,3-dioxolo[4,5- <i>e</i>]dioxaphosphepin.....	323
$C_{58}H_{48}Cl_2NP_3Ru$	Dichloro[(R)-bis(diphenylphosphino)-1,1'-binaphthyl][2-(diphenylphosphino)ethylamine]ruthenium(II), min. 97%.....	383	$C_{62}H_{62}O_6Ru_2$	1-Hydroxytetraphenylcyclopentadienyl(tetraphenyl-2,4-cyclopentadien-1-one)- μ -hydrotracetarobonyldiruthenium(II), 98%.....	397
$C_{58}H_{46}Cl_2N_2P_2Ru$	Dichloro[(S)-(-)-2,2'-bis(diphenylphosphino)-1,1'-binaphthyl][(1R,2R)-(+)-1,2-diphenylethylenediamine]ruthenium(II), min. 98%.....	385	$C_{62}H_{52}F_6N_4O_6S_2$	11,12-Bis[<i>N</i> -(2,2-diphenyl-1-ethyl)-1H-benzimidazolium(-3-methylene)-9,10-dihydro-9,10-ethanoanthracene bis(trifluoromethanesulfonate), min. 95%.....	183
	Dichloro[(R)-(+)-2,2'-bis(diphenylphosphino)-1,1'-binaphthyl][(1R,2R)-(+)-1,2-diphenylethylenediamine]ruthenium(II), min. 90%.....	384	$C_{62}H_{60}N_4O_4Pd_2$	1,3-Bis(2,4,6-trimethylphenyl)imidazol-2-ylidene(1,4-naphthoquinone)palladium(0) dimer, 96%.....	229
	Dichloro[(R)-(+)-2,2'-bis(diphenylphosphino)-1,1'-binaphthyl][(1S,2S)-(-)-1,2-diphenylethylenediamine]ruthenium(II), min. 98%.....	385	$C_{62}H_{62}ClP_2Ru$	Chloro[(R)-(+)-2,2'-bis(di(3,5-xylyl)phosphino)-1,1'-binaphthyl](<i>p</i> -cymene)ruthenium(II) chloride [RuCl(<i>p</i> -cymene)((R)-xylinap)]Cl.....	375
$C_{58}H_{54}Cl_2P_2Ru$	Chloro[(R)-(+)-2,2'-bis(di- <i>p</i> -tolylphosphino)-1,1'-binaphthyl](<i>p</i> -cymene)ruthenium(II) chloride [RuCl(<i>p</i> -cymene)((R)-tolbinap)]Cl.....	375	$C_{62}H_{62}Cl_2P_2Ru$	Chloro[(S)-(-)-2,2'-bis(di(3,5-xylyl)phosphino)-1,1'-binaphthyl](<i>p</i> -cymene)ruthenium(II) chloride [RuCl(<i>p</i> -cymene)((S)-xylinap)]Cl.....	375
	Chloro[(S)-(-)-2,2'-bis(di- <i>p</i> -tolylphosphino)-1,1'-binaphthyl](<i>p</i> -cymene)ruthenium(II) chloride [RuCl(<i>p</i> -cymene)((S)-tolbinap)]Cl.....	375	$C_{62}H_{66}Cl_2N_2P_2Ru$	Dichloro[(R)-(-)-4,12-bis(di(3,5-xylyl)phosphino)[2,2'-paracyclophane][(1S,2S)-(-)-1,2-diphenylethylenediamine]ruthenium(II), min. 95%.....	391
$C_{59}H_{52}Cl_2N_3P_2Ru$	Dichloro[(S)-(-)-2,2'-bis(di- <i>p</i> -tolylphosphino)-1,1'-binaphthyl][(S)-(-)-2-(α -(<i>i</i> -propyl) methanamine)-1H-benzimidazole]ruthenium(II), min. 95%.....	389		Dichloro[(S)-(+)-4,12-bis(di(3,5-xylyl)phosphino)[2,2'-paracyclophane][(1R,2R)-(+)-1,2-diphenylethylenediamine]ruthenium(II), min. 95%.....	391
	Dichloro[(R)-(+)-2,2'-bis(di- <i>p</i> -tolylphosphino)-1,1'-binaphthyl][(R)-(+)-2-(α -(<i>i</i> -propyl) methanamine)-1H-benzimidazole]ruthenium(II), min. 95%.....	388	$C_{63}H_{54}O_{15}Pd_2$	Tris[di(4-acetoxybenzylidene)acetone]dipalladium(0) di(4-acetoxybenzylidene)acetone adduct, min. 97%.....	249
$C_{60}H_{36}Li_3O_6Y$	Lithium tris(S-(-)-1,1'-binaphthyl-2,2'-diolato)yttrate(III) tetrahydrofuran adduct, min. 97%.....	119	$C_{63}H_{58}BClF_4N_2O_2P_2Ru$	Chloro[(R)-(-)-2,2'-bis(diphenylphosphino)-1,1'-binaphthyl][(R)-1,1-bis(4-methoxyphenyl)-3-methylbutane-1,2-diamine]ruthenium(II) tetrafluoroborate, min. 97%.....	372
$C_{60}H_{40}BF_{20}N_3O_2RuS$	{[(1R,2R)-2-Amino-1,2-diphenylethyl](4-toluenesulfonyl)amido}(<i>p</i> -cymene)(pyridine)ruthenium(II) tetrakis(pentafluorophenyl) borate, min. 97%.....	364		Chloro[(S)-(-)-2,2'-bis(diphenylphosphino)-1,1'-binaphthyl][(S)-1,1-bis(4-methoxyphenyl)-3-methylbutane-1,2-diamine]ruthenium(II) tetrafluoroborate, min. 97%.....	372
$C_{60}H_{42}F_{24}FeN_2P_2$	{[(1S,2S)-2-Amino-1,2-diphenylethyl](4-toluenesulfonyl)amido}(<i>p</i> -cymene)(pyridine)ruthenium(II) tetrakis(pentafluorophenyl) borate, min. 97%.....	364	$C_{63}H_{58}Cl_2N_2O_2P_2Ru$	Dichloro[(R)-(+)-2,2'-bis(diphenylphosphino)-1,1'-binaphthyl][(2R)-(-)-1,1-bis(4-methoxyphenyl)-3-methyl-1,2-butanediamine]ruthenium(II) dichloromethane adduct, min. 97%.....	384
	{[(1S,2S)-(-)-1,2-diphenylethylenediamine]ruthenium(II) RuCl ₂ [(R)-dm-segphos®][(R,R)-dpen].....	389		Dichloro[(S)-(-)-2,2'-bis(diphenylphosphino)-1,1'-binaphthyl][(2S)-(+)-1,1-bis(4-methoxyphenyl)-3-methyl-1,2-butanediamine]ruthenium(II) dichloromethane adduct, min. 97%.....	384
$C_{60}H_{52}Cl_2N_3P_2Ru$	Dichloro[(S)-(-)-2,2'-bis(di- <i>p</i> -tolylphosphino)-1,1'-binaphthyl][(S)-(-)-2-(α -(<i>t</i> -butyl) methanamine)-1H-benzimidazole]ruthenium(II), min. 97%.....	388	$C_{64}H_{74}FeN_2O_4P_2$	(S,S)-(-)-2,2'-Bis[(R)-(N,N-dimethylamino)(phenyl)methyl]-1,1'-bis(di(3,5-dimethylphenyl)phosphino)ferrocene, min. 97%.....	96
$C_{60}H_{60}Cl_2N_2O_4P_2Ru$	Dichloro[(R)-(+)-5,5'-bis(di(3,5-xylyl)phosphino)-4,4'-bi-1,3-benzodioxole][(1R,2R)-(+)-1,2-diphenylethylenediamine]ruthenium(II) RuCl ₂ [(R)-dm-segphos®][(R,R)-dpen].....	389		Dichloro[(R)-bis(diphenylphosphino)-1,1'-binaphthyl][(1S,2S)-2-amino-1-phenylpropyl]diphenylphosphine]ruthenium(II), min. 97%.....	384
	Dichloro[(S)-(-)-5,5'-bis(di(3,5-xylyl)phosphino)-4,4'-bi-1,3-benzodioxole][(1S,2S)-(-)-1,2-diphenylethylenediamine]ruthenium(II) RuCl ₂ [(S)-dm-segphos®][(S,S)-dpen].....	389	$C_{65}H_{70}Cl_2N_2O_6P_2Ru$	Dichloro[(R)-(+)-5,5'-bis(di(3,5-xylyl)phosphino)-4,4'-bi-1,3-benzodioxole][(2R)-(-)-1,1-bis(4-methoxyphenyl)-3-methyl-1,2-butanediamine]ruthenium(II) RuCl ₂ [(R)-dm-segphos®][(R)-daipen].....	389
$C_{60}H_{66}Cl_2N_4O_4P_2Ru$	Dichloro[(S)-(-)-2,2',6,6'-tetramethoxy-4,4'-bis(di(3,5-xylyl)phosphino)-3,3'-bipyridine][(1S,2S)-(-)-1,2-diphenylethylenediamine]ruthenium(II), min. 95%.....	393			
	Dichloro[(R)-(+)-2,2',6,6'-tetramethoxy-4,4'-bis(di(3,5-xylyl)phosphino)-3,3'-bipyridine][(1R,2R)-(+)-1,2-diphenylethylenediamine]ruthenium(II), min. 95%.....	393			

Formula Index

Formula	Description	Page	Formula	Description	Page
	Dichloro((S)-(-)-5,5'-bis[di(3,5-xylyl)phosphino]-4,4'-bi-1,3-benzodioxole)((2S)-(+)-1,1-bis(4-methoxyphenyl)-3-methyl-1,2-butane-diamine)ruthenium(II) RuCl ₂ [(S)-dm-seg-phos@]((S)-daipen)	389	C ₇₁ H ₅₄ BF ₂₄ IrNOP	1,5-Cyclooctadiene((4S)-(+)-2-[(5S)-6-(di-phenylphosphino)spiro[4.4]nona-1,6-dien-1-yl]-4,5-dihydro-4-benzylloxazole)iridium(I) tetrakis[3,5-bis(trifluoromethyl)phenyl]borate, 97% (S,S)-(COD)Ir[Bn-SpinPHOX]	89
C ₆₆ H ₆₂ FeBFP ₄	Tris[[2-(diphenylphosphino)ethyl]phosphine] (fluoro)iron(II) tetraphenylborate, min. 98% ...	111	C ₇₁ H ₇₂ Cl ₂ N ₂ O ₂ P ₂ Ru	Chloro((R)-(+)-2,2'-bis[di(3,5-xylyl)phosphino]-1,1'-binaphthyl)][(2R)-(+)-1-(4-methoxyphenyl)-1'-(4-methoxyphenyl)-kC]-3-methyl-1,2-butanediamine)ruthenium(II) (R)-RUCY™-XylBINAP	376
C ₆₆ H ₆₂ FeP ₄	4,4'-Bis(t-butyl)-1,1',2,2'-tetrakis(diphenylphosphino)ferrocene, 98% HiersoPHOS-5....	94	C ₇₁ H ₇₂ Cl ₂ N ₂ O ₂ P ₂ Ru	Dichloro((R)-(+)-2,2'-bis[di(3,5-xylyl)phosphino]-1,1'-binaphthyl)][(2S)-(+)-1-bis(4-methoxyphenyl)-3-methyl-1,2-butanediamine)ruthenium(II) RuCl ₂ [(R)-xylbinap]((R,R)-dpem)	390
C ₆₆ H ₆₄ Cl ₂ N ₂ P ₂ Ru	Dichloro((R)-(+)-2,2'-bis[di(3,5-xylyl)phosphino]-1,1'-binaphthyl)][(1R,2R)-(+)-1,2-diphenylethylenediamine]ruthenium(II) RuCl ₂ [(R)-xylbinap]((R,R)-dpem)	390	C ₇₁ H ₇₂ Cl ₂ N ₂ O ₂ P ₂ Ru	Dichloro((S)-(-)-2,2'-bis[di(3,5-xylyl)phosphino]-1,1'-binaphthyl)][(1S,2S)-(-)-1,2-diphenylethylenediamine]ruthenium(II) RuCl ₂ [(S)-xylbinap]((S,S)-dpem)	390
C ₆₆ H ₁₁₇ O ₂₁	DL-α-Tocopherol methoxypolyethylene glycol succinate solution (2 wt% in water) TPGS-750-M	221	C ₇₁ H ₇₂ Cl ₂ N ₂ O ₂ P ₂ Ru	Chloro((R)-(+)-2,2'-bis[di(3,5-xylyl)phosphino]-1,1'-binaphthyl)][(2S)-(+)-1-bis(4-methoxyphenyl)-1'-(4-methoxyphenyl)-kC]-3-methyl-1,2-butanediamine)ruthenium(II) (S)-RUCY™-XylBINAP	376
C ₆₇ H ₅₄ B-F ₂₄ IrNOP	1,5-Cyclooctadiene((4S)-(+)-2-[(5S)-6-(di-phenylphosphino)spiro[4.4]nona-1,6-dien-1-yl]-4,5-dihydro-4-(i-propyl)oxazole)iridium(I) tetrakis[3,5-bis(trifluoromethyl)phenyl]borate, 97% (S,S)-(COD)Ir[Pr-SpinPHOX]	89	C ₇₁ H ₇₂ Cl ₂ N ₂ O ₂ P ₂ Ru	Dichloro((R)-(+)-2,2'-bis[di(3,5-xylyl)phosphino]-1,1'-binaphthyl)][(2R)-(+)-1-bis(4-methoxyphenyl)-3-methyl-1,2-butanediamine) ruthenium(II) RuCl ₂ [(R)-xylbinap]((R)-daipen)	390
C ₆₈ H ₁₃₇ Br	2-Methyl-3-[polyisobutyl(12)]propyl bromide (50% in heptane/polyisobutylene)	39	C ₇₂ H ₂₇ F ₆₄ P ₃ Pd	Tris[tris(3,5-bis(trifluoromethyl)phenyl)phosphine]palladium(0), 99%	250
C ₆₈ H ₉₆ N ₂ O ₂	N,N'-Bis(2,6-bis(diphenylmethyl)-4-methoxyphenyl)imidazol-2-ylidene, min. 98% IP*OMe	180	C ₇₂ H ₆₀ P ₂ Pd	Tetrakis(triphenylphosphine)palladium(0), 99% (99.9+%Pd)	248
C ₆₈ H ₆₂ Cl ₂ NP ₃ Ru	Dichloro((R)-2,2'-bis[bis(4-methylphenyl)-1,1'-binaphthyl]][(1R,2R)-2-amino-1-phenylpropyl]diphenylphosphine ruthenium(II), min. 97%	382	C ₇₂ H ₆₀ P ₄ Pt	Tetrakis(triphenylphosphine)platinum(0), 98%	339
C ₇₀ H ₅₂ BF ₂₄ IrNOP	1,5-Cyclooctadiene((4S)-(+)-2-[(5S)-6-(di-phenylphosphino)spiro[4.4]nona-1,6-dien-1-yl]-4,5-dihydro-4-phenylloxazole)iridium(I) tetrakis[3,5-bis(trifluoromethyl)phenyl]borate, 97% (S,S)-(COD)Ir[Ph-SpinPHOX]	89	C ₇₂ H ₆₀ P ₄ Ru	Dihydrotetrakis(triphenylphosphine)ruthenium(II), 95%	394
C ₇₀ H ₅₆ BCIF ₄ NP ₃ Ru	Chloro((R)-2,2'-bis(diphenylphosphino)-1,1'-binaphthyl)][(1R,2R)-2-(diphenylphosphino)-1,2-diphenylethanamine] ruthenium(II) tetrafluoroborate, min. 97%	373	C ₇₂ H ₆₁ P ₄ Rh	Hydrotetrakis(triphenylphosphine)ruthenium(II), 99%	358
C ₇₀ H ₆₅ BF ₂₄ IrN ₃ O	{1-(4S)-2-(1-Adamantyl-4,5-dihydrooxazolyl)ethyl}-3-(2,6-di-i-propylphenyl)imidazolin-2-ylidene}(1,5-cyclooctadiene)iridium(I) tetrakis[3,5-bis(trifluoromethyl)phenyl]borate, 99%	84	C ₇₂ H ₈₄ N ₄ O ₂₄	Perallyloxycurbit[6]uril (AOCB[6]) potassium sulfate, 94+%	205
C ₇₀ H ₆₇ BF ₂₄ IrN ₃ O	{1-(4R)-2-(1-Adamantyl-4,5-dihydrooxazolyl)ethyl}-3-(2,6-di-i-propylphenyl)imidazolin-2-ylidene}(1,5-cyclooctadiene)iridium(I) tetrakis[3,5-bis(trifluoromethyl)phenyl]borate, 99%	84	C ₇₂ H ₈₈ N ₄ O ₁₆ Rh ₂	Tetrakis[5-t-butyl-pis(thaloyl-N(S)-tert-leucinate)dirhodium bis(ethyl acetate) adduct Rh ₂ (S-terpPTL) ₄	360
C ₇₀ H ₈₄ Co ₂ F ₆ N ₄ O ₂₀ S ₂	Cyclic-Oligo Bis((1R,2R)-(+)-1,2-cyclohexanediamino-N,N'-bis(3,3'-di-t-butylsali-cylidene) cobalt(III)triflate)-5,5'-bis(2-carboxyethyl)ether	51	C ₇₄ H ₄₆ BCIF ₂₀ N ₂ P ₂ Ru	Chloro((R)-2,2'-bis(diphenylphosphino)-1,1'-binaphthyl)][(1R,2R)-cyclohexane-1,2-diamine]ruthenium(II) tetrakis(pentafluorophenyl)borate, min. 97%	373
C ₇₀ H ₉₆ O ₂ P ₂	Cyclic-Oligo Bis((1S,2S)-(-)-1,2-cyclohexanediamino-N,N'-bis(3,3'-di-t-butylsali-cylidene) cobalt(III)triflate)-5,5'-bis(2-carboxyethyl)ether	51	C ₇₄ H ₆₀ BCl ₂ CoF ₂₄ N ₆	Chloro((S)-2,2'-bis(diphenylphosphino)-1,1'-binaphthyl)][(1S,2S)-cyclohexane-1,2-diamine]ruthenium(II) tetrakis(pentafluorophenyl)borate, min. 97%	373
C ₇₀ H ₉₆ O ₂ P ₂	(R)-(+)-2,2'-Bis[di(3,5-di-t-butylphenyl)phosphino]-6,6'-dimethoxy-1,1'-biphenyl, min. 97%	260	C ₇₄ H ₆₀ BCl ₂ CoF ₂₄ N ₆	lambda-Tris[(1S,2S)-1,2-diphenyl-1,2-ethanediamine]cobalt(III) chloride tetrakis[3,5-bis(trifluoromethyl)phenyl]borate trihydrate SKJ-3	52
C ₇₀ H ₁₀₀ N ₄ O ₂ P ₂	(S)-(-)-2,2'-Bis[di(3,5-di-t-butylphenyl)phosphino]-6,6'-dimethoxy-1,1'-biphenyl, min. 97%	260	C ₇₄ H ₈₄ N ₄ O ₈ Pd ₂	1,3-Bis(2,6-di-i-propylphenyl)imidazol-2-ylidene(1,4-naphthoquinone)palladium(0) dimer, 96%	228
C ₇₀ H ₁₀₀ N ₄ O ₂ P ₂	(S)-(+)-2,2'-Bis[di(3,5-di-t-butylphenyl)phosphino]-6,6'-dimethoxy-1,1'-biphenyl, min. 97%	260	C ₇₄ H ₁₀₀ O ₈ P ₂	(R)-(-)-5,5'-Bis[di(3,5-di-t-butyl-4-methoxyphenyl)phosphino]-4,4'-bi-1,3-benzodioxole, min. 98% (R)-(-)-DTBM-SEGPHOS@	259
C ₇₀ H ₁₀₀ N ₄ O ₂ P ₂	(R)-(+)-2,2'-Bis[di(3,5-di-i-propyl-4-dimethylaminophenyl)phosphino]-6,6'-dimethoxy-1,1'-biphenyl, min. 97%	261	C ₇₄ H ₁₀₄ O ₆ P ₂	(S)-(+)-5,5'-Bis[di(3,5-di-t-butyl-4-methoxyphenyl)phosphino]-4,4'-bi-1,3-benzodioxole, min. 98% (S)-(+)-DTBM-SEGPHOS@	260
C ₇₀ H ₁₀₀ N ₄ O ₂ P ₂	(S)-(+)-2,2'-Bis[di(3,5-di-i-propyl-4-dimethylaminophenyl)phosphino]-6,6'-dimethoxy-1,1'-biphenyl, min. 97%	261	C ₇₄ H ₁₀₄ O ₆ P ₂	(R)-(-)-2,2'-Bis[di(3,5-di-t-butyl-4-methoxyphenyl)phosphino]-6,6'-dimethoxy-1,1'-biphenyl, min. 97%	260
C ₇₀ H ₁₀₀ N ₄ O ₂ P ₂	(S)-(+)-2,2'-Bis[di(3,5-di-i-propyl-4-dimethylaminophenyl)phosphino]-6,6'-dimethoxy-1,1'-biphenyl, min. 97%	261	C ₇₆ H ₁₀₈ O ₈ P ₂	(R)-2,2'-Bis[bis(4-methoxy-3,5-di-t-butylphenyl)phosphino]-4,4',6,6'-tetramethoxy-1,1'-biphenyl, min. 97% (R)-DTBM-Garpos™	253

Formula Index

Formula	Description	Page	Formula	Description	Page
	(S)-2,2'-Bis[bis(4-methoxy-3,5-di- <i>t</i> -butylphenyl)phosphino]-4,4',6,6'-tetramethoxy-1,1'-biphenyl, min. 97% (S)-DTBM-Garphos™	253		Tetrakis((S)-(+)-[(1S)-1-(4-bromophenyl)-2,2-diphenylcyclopropanecarboxylato]dirhodium(II) Rh ₂ (S-BTPCP) ₄	359
C ₇₇ H ₅₆ BF ₂₄ IrNO ₂ P	((4S,5S)-)-O-[1-Benzyl-1-(5-methyl-2-phenyl-4,5-dihydrooxazol-4-yl)-2-phenylethyl]diphenylphosphinite(1,5-COD)iridium(I) tetrakis(3,5-bis(trifluoromethyl)phenyl)borate, min. 97% (S,S)-[COD]Ir[Ph ₂ PThrePHOX].....	85	C ₉₀ H ₇₁ Cl ₅ NP ₄ Ru ₂	4-[Polyisobutyl(20)]-2,6-dimethylaniline (50% in heptane/polyisobutylene)	205
C ₇₇ H ₇₆ BF ₂₄ IrNO ₂ P	((4S,5S)-)-O-[1-Benzyl-1-(5-methyl-2-phenyl-4,5-dihydrooxazol-4-yl)-2-phenylethyl]dicyclohexylphosphinite(1,5-COD)iridium(I) tetrakis(3,5-bis(trifluoromethyl)phenyl)borate, min. 97% (R,R)-[COD]Ir[Ph ₂ PThrePHOX].....	85	C ₉₀ H ₈₇ Cl ₅ NP ₄ Ru ₂	Dimethylammonium dichlorotri(μ-chloro) bis((R)-(+)-2,2'-bis(diphenylphosphino)-1,1'-binaphthyl)diruthenate(II) [NH ₂ Me ₃][{RuCl((R)-binap)} ₂ (μ-Cl)] ₂	395
C ₇₈ H ₅₆ Cl ₅ NO ₈ P ₄ Ru ₂	((4R,5R)-(+)-O-[1-Benzyl-1-(5-methyl-2-phenyl-4,5-dihydrooxazol-4-yl)-2-phenylethyl] (dicyclohexylphosphinite)(1,5-COD)iridium(I) tetrakis(3,5-bis(trifluoromethyl)phenyl)borate, min. 97% (R,R)-[COD]Ir[cy ₂ PThrePHOX].....	85	C ₉₄ H ₅₆ BClF ₂₀ N ₃ P ₃ Ru	Dimethylammonium dichlorotri(μ-chloro) bis((S)-(-)-5,5'-bis(diphenylphosphino)-4,4'-bi-1,3-benzodioxole)diruthenate(II) [NH ₂ Me ₃][{RuCl((S)-segphos@)} ₂ (μ-Cl)] ₂	395
C ₇₈ H ₆₆ Cl ₂ N ₂ Pd	Dimethylammonium dichlorotri(μ-chloro) bis((R)-(+)-5,5'-bis(diphenylphosphino)-4,4'-bi-1,3-benzodioxole)diruthenate(II) [NH ₂ Me ₃][{RuCl((R)-segphos@)} ₂ (μ-Cl)] ₂	395	C ₉₄ H ₉₆ Cl ₅ NO ₈ P ₄ Ru ₂	Dimethylammonium dichlorotri(μ-chloro) bis((S)-(-)-5,5'-bis(di(3,5-xylyl)phosphino)-4,4'-bi-1,3-benzodioxole)diruthenate(II) [NH ₂ Me ₃][{RuCl((S)-dm-segphos@)} ₂ (μ-Cl)] ₂	394
C ₇₈ H ₁₀₆ O ₁₂ P ₂ Ru	Chloro([1,2,3-η)-1-phenyl-2-propen-1-yl]-{[1,3-bis(2,6-bis(diphenylmethyl)-4-methylphenyl)-2H-imidazol-2-ylidene]palladium(II), min. 97%.....	234	C ₉₆ H ₁₇₈ P	Dimethylammonium dichlorotri(μ-chloro) bis((R)-(+)-5,5'-bis(di(3,5-xylyl)phosphino)-4,4'-bi-1,3-benzodioxole)diruthenate(II) [NH ₂ Me ₃][{RuCl((S)-dm-segphos@)} ₂ (μ-Cl)] ₂	394
C ₇₈ H ₁₅₀ O	Diacetato((R)-(-)-5,5'-bis(di(3,5-di- <i>t</i> -butyl-4-methoxyphenyl)phosphino)-4,4'-bi-1,3-benzodioxole)ruthenium(II) Ru(OAc) ₂ [(R)-dtbm-segphos@].....	379	C ₉₈ H ₈₇ Cl ₅ NP ₄ Ru ₂	2-Methyl-3-[polyisobutyl(20)]propyl]diphenylphosphine (50% in heptane/polyisobutylene)	315
C ₇₉ H ₁₅₀ O ₂	Diacetato((S)-(+)-5,5'-bis(di(3,5-di- <i>t</i> -butyl-4-methoxyphenyl)phosphino)-4,4'-bi-1,3-benzodioxole)ruthenium(II) Ru(OAc) ₂ [(S)-dtbm-segphos@].....	380	C ₁₀₆ H ₁₉₁ OP	Dimethylammonium dichlorotri(μ-chloro) bis((R)-(+)-2,2'-bis(di- <i>p</i> -tolylphosphino)-1,1'-binaphthyl)diruthenate(II) [NH ₂ Me ₃][{RuCl((R)-tolbinap)} ₂ (μ-Cl)] ₂	396
C ₇₉ H ₁₅₀ O ₂	4-[Polyisobutyl(18)]phenol (50% in heptane/polyisobutylene)	40	C ₁₀₆ H ₁₀₃ Cl ₅ NP ₄ Ru ₂	Dimethylammonium dichlorotri(μ-chloro) bis((R)-(+)-2,2'-bis(di(3,5-xylyl)phosphino)-1,1'-binaphthyl)diruthenate(II) [NH ₂ Me ₃][{RuCl((S)-xylinap)} ₂ (μ-Cl)] ₂	394
C ₈₀ H ₈₀ N ₄ O ₁₆ Rh ₂	5-[Polyisobutyl(18)]-2-hydroxybenzaldehyde (50% in heptane/polyisobutylene)	39	C ₁₁₂ H ₁₄₆ F ₈ O ₂ Pd ₂	Dimethylammonium dichlorotri(μ-chloro) bis((S)-(-)-2,2'-bis(di(3,5-xylyl)phosphino)-1,1'-binaphthyl)diruthenate(II) [NH ₂ Me ₃][{RuCl((S)-xylinap)} ₂ (μ-Cl)] ₂	394
C ₈₀ H ₈₀ N ₄ O ₁₆ Rh ₂	Tetrakis((R)-(-)-(1-adamantyl)-(N-phthalimido)acetato)dirhodium(II) Rh ₂ (R-PTAD) ₄	359	C ₁₁₂ H ₁₄₆ F ₈ O ₂ Pd ₂	Dimethylammonium dichlorotri(μ-chloro) bis((S)-(-)-2,2'-bis(di(3,5-xylyl)phosphino)-1,1'-binaphthyl)diruthenate(II) [NH ₂ Me ₃][{RuCl((S)-xylinap)} ₂ (μ-Cl)] ₂	394
C ₈₂ H ₁₅₈ O	Tetrakis((S)-(+)-(1-adamantyl)-(N-phthalimido)acetato)dirhodium(II) Rh ₂ (S-PTAD) ₄	359	C ₈₄ H ₁₁₄ Cl ₂ O ₈ P ₂ Ru	4-Diphenylphosphinophenyl[2-methyl-3-[polyisobutyl(20)]propyl]ether (50% in heptane/polyisobutylene)	308
C ₈₃ H ₁₅₈ O ₂	4-[Polyisobutyl(18)]-2-(<i>t</i> -butyl)phenol (50% in heptane/polyisobutylene)	39	C ₁₁₂ H ₁₄₆ F ₈ O ₂ Pd ₂	Bis[[2-(Diadamantyl)phosphino]-3-methoxy-2',4',6'-tri- <i>i</i> -propyl-3'-(2,3,5,6-tetrafluoro-4-butylphenyl)-1,1'-biphenyl]palladium(0)]1,5-cyclooctadiene, [AlPhos Palladium complex]	227
C ₈₄ H ₁₁₄ Cl ₂ O ₈ P ₂ Ru	5-[Polyisobutyl(18)]-2-hydroxy-3-(<i>t</i> -butyl)benzaldehyde (50% in heptane/polyisobutylene)	40	C ₁₂ H ₃₂ N ₄ Si	Tetrakis(ethylmethylamino)silane, 98%, TEMAS	410
C ₈₄ H ₁₁₄ Cl ₂ O ₈ P ₂ Ru	Chloro((R)-(-)-5,5'-bis(di(3,5-di- <i>t</i> -butyl-4-methoxyphenyl)phosphino)-4,4'-bi-1,3-benzodioxole)(<i>p</i> -cymene)ruthenium(II) chloride [RuCl(<i>p</i> -cymene)((R)-dtbm-segphos@)Cl].....	371	C ₁₆ H ₂₈ NP	[2-(N,N-Dimethylamino)phenyl]di- <i>t</i> -butylphosphine, min. 95%	298
C ₈₄ H ₁₁₄ Cl ₂ O ₈ P ₂ Ru	Chloro((S)-(+)-5,5'-bis(di(3,5-di- <i>t</i> -butyl-4-methoxyphenyl)phosphino)-4,4'-bi-1,3-benzodioxole)(<i>p</i> -cymene)ruthenium(II) chloride [RuCl(<i>p</i> -cymene)((S)-dtbm-segphos@)Cl].....	371	C ₁₇₉ H ₃₄₃ N ₂ Cl	1,3-Bis(2,3-dimethyl-4-[polyisobutyl(20)]phenyl)imidazolium chloride (50% in hexanes/polyisobutylene)	183
C ₈₄ H ₁₆₃ N	4-[Polyisobutyl(18)]-2,6-(di- <i>i</i> -propyl)aniline (50% in heptane/polyisobutylene)	205	C ₁₈₇ H ₃₅₉ N ₂ Cl	1,3-Bis(2,6-di- <i>i</i> -propyl-4-[polyisobutyl(20)]phenyl)imidazolium chloride (50% in hexanes/polyisobutylene)	184
C ₈₇ H ₅₆ BClF ₂₀ N ₂ O ₂ P ₂ Ru	Chloro((S)-(-)-2,2'-bis(diphenylphosphino)-1,1'-binaphthyl)][(S)-1,1-bis(4-methoxyphenyl)-3-methylbutane-1,2-diamine]ruthenium(II) tetrakis(pentafluorophenyl)borate, min. 97%.....	372			
C ₈₈ H ₅₆ Fe ₂ N ₈ O	Iron(III) meso-tetraphenylporphine-μ-oxo dimer.....	109			
C ₈₈ H ₆₄ Br ₄ O ₈ Rh ₂	Tetrakis((R)-(-)-[(1R)-1-(4-bromophenyl)-2,2-diphenylcyclopropanecarboxylato]dirhodium(II) Rh ₂ (R-BTPCP) ₄	359			

Formula Index

Formula	Description	Page	Formula	Description	Page
C ₂₁₁ H ₄₀₇ N ₂ BF ₄	1,3-Bis(2,3-dimethyl-4-[polyisobutyl(24) phenyl]-4,5-dihydroimidazolium tetrafluoroborate (50% in hexanes/polyisobutylene).....	182		Cadmium selenide CANdot® quantum dot (CdSe core), 50umol/L in hexanes, 525nm peak emission.....	139
C ₂₁₆ H ₁₈₈ Au ₅₅ Cl ₆	Hexachlorododecakis[diphenyl(m-sulfonophenyl)phosphine]pentapentacontagold, dodecasodium salt (water soluble) Schmid Au ₅₅ Cluster	158		Cadmium selenide CANdot® quantum dot (CdSe core), 50umol/L in hexanes, 550nm peak emission.....	139
C ₂₁₆ H ₁₈₀ Au ₅₅ Cl ₆	Hexachlorododecakis(triphenylphosphine) pentapentacontagold Schmid Au ₅₅ Cluster ...	158		Cadmium selenide CANdot® quantum dot (CdSe core), 50umol/L in hexanes, 575nm peak emission.....	139
P ₁₂	(11bR)-8,9,10,11,12,13,14,15-Octahydro-4-hydroxy-2,6-di-1-naphthalenyl-4-oxide-dinaphtho[2,1-d:1',2'-f][1,3,2]dioxaphospepin, 98%, (99% ee).....	317	CdTe	Cadmium telluride (99.999%-Cd) PURATREM.....	34
C ₄₀ H ₃₃ O ₄ P				Cadmium telluride (99.999%-Cd) PURATREM.....	34
C ₅ H ₅ In	Cyclopentadienylindium(I), elec. gr. (99.99+%-In) PURATREM, 97-3425, contained in 50 ml electropolished Swagelok® cylinder (96-1077) for CVD/ALD.....	79	Cd ₃ As ₂	Cadmium arsenide (99.999%-Cd) PURATREM.....	32
CaCl ₂	Calcium chloride hydrate (99.999+%-Ca) PURATREM.....	35	CeCl ₃	Cerium(III) chloride hydrate (99.99%-Ce) (REO) PURATREM.....	41
CaCl ₂ O ₈	Calcium perchlorate hydrate, 99%	36		Cerium(III) chloride hydrate (99.9%-Ce) (REO).....	41
CaCrO ₄	Calcium chromate, min. 95%.....	35		Cerium(III) chloride, anhydrous (H ₂ O < 0.5%) (99.9%-Ce) (REO).....	40
CaF ₂	Calcium fluoride (99.9%-Ca).....	35	CeCl ₃ O ₁₂	Cerium(III) perchlorate hexahydrate, reagent	42
CaH ₂ O ₄ P	Calcium phosphate, dibasic (99.95%-Ca)	36	CeF ₃	Cerium(III) fluoride (99.9%-Ce) (REO).....	41
CaH ₂	Calcium hydride, 95%.....	35	CeF ₄	Cerium(IV) fluoride, anhydrous, 99%	41
CaH ₄ O ₃ P ₂	Calcium phosphate, monobasic, monohydrate, 99%	36	CeH ₂ O ₄	Cerium(IV) fluoride, hydrate	41
CaI ₂	Calcium iodide, anhydrous, 98+%	35	CeH ₈ N ₈ O ₁₈	Ammonium cerium(IV) nitrate, 98.5+% (ACS).....	5
CaI ₂ O ₆	Calcium iodide hydrate, min. 98%	35	CeI ₃	Cerium(III) iodide hydrate	41
CaI ₂ O ₈	Calcium iodate, 98%	35	CeN	Cerium nitride (99.9%-Ce).....	41
CaMoO ₄	Calcium molybdate (99.9+%-Ca)	35	CeN ₃ O ₉	Cerium(III) nitrate hexahydrate (99.9%-Ce) (REO)	41
CaNa ₂ O ₆	Calcium nitrate tetrahydrate, 99%	35		Cerium(III) nitrate hexahydrate (99.99%-Ce) (REO) PURATREM	41
CaO	Calcium oxide, 98%	35	CeO ₂	Cerium(IV) oxide (99.995%-Ce) PURATREM.....	41
CaO ₂ Ti	Calcium titanate, 99%.....	36		Cerium(IV) oxide (99.9%-Ce) (REO).....	41
CaO ₄ S	Calcium sulfate dihydrate, 98+% (ACS).....	36		Cerium(IV) oxide nanopowder.....	150
CaO ₄ W	Calcium tungstate, 98%.....	36		Cerium(IV) oxide [contains some Ce(III)] in water at pH = 9.0 +0.5 (CEO-W290).....	149
CaS	Calcium sulfide (99.9+%-Ca).....	36		Cerium(IV) oxide [contains some Ce(III)] in water at pH = 3.5 +0.75 (CEO-W320).....	150
CaSi ₃	Calcium silicide, 90% (~4% Fe, ~6% Ba+Al).	36	CeO ₄ P	Cerium(III) phosphate (99.9%-Ce) (REO)	42
Ca ₃ O ₇ P ₂	Calcium pyrophosphate (99.95%-Ca)	36	CeO ₂ /Fe ₂ O ₃	Mixed metal oxides of cerium(IV) [contains some Ce(III)] and iron(III) in water at pH 4.75 +0.25 (CEF-W420).....	149
Ca ₃ N ₂	Calcium nitride (99%-Ca)	35		Cerium(III) sulfate octahydrate (99%-Ce) (REO)	42
Ca ₃ P ₂	Calcium phosphide, 97%	36	Ce ₂ O ₁₂ S ₃	Cerium(III) tungstate (99.9%-Ce) (REO)	42
Ca ₁₀ H ₂ O ₂₆ P ₆	Calcium phosphate, tribasic (~37% Ca)	36	Ce ₂ O ₁₂ W ₃	Cesium chloride (99.9%-Cs)	43
CdCl ₂	Cadmium chloride hydrate (99.998%-Cd) PURATREM.....	32	ClCs	Cesium chloride (99+%-Cs)	43
	Cadmium chloride, anhydrous (99.995%-Cd) PURATREM.....	32		Cesium chloride (99.999%-Cs) PURATREM.....	43
	Cadmium chloride, (99.999%-Cd) (O ₂ < 50ppm) PURATREM	32	ClCsO ₄	Cesium perchlorate (99.9%-Cs)	44
CdCl ₂ O ₈	Cadmium perchlorate hexahydrate, 99%	32	CiCu	Copper(I) chloride (99.99%-Cu) PURATREM	56
CdF ₂	Cadmium fluoride (99.98%-Cd).....	32		Copper(I) chloride, anhydrous, 97+%	56
	Cadmium fluoride, 99%	32	ClH ₄ N	Ammonium chloride, 99.5+% (ACS).....	5
CdI ₂	Cadmium iodide, 99%	32		Ammonium chloride (99.999%-Cd) PURATREM	5
CdN ₂ O ₈	Cadmium nitrate tetrahydrate, 98%.....	32	ClIn	Indium(I) chloride, anhydrous (99.99%-In) PURATREM.....	80
CdO	Cadmium oxide (99.999%-Cd) PURATREM	32		Potassium chloride, 99+% (99.99+%-K) optical grade PURATREM	341
	Cadmium oxide (99.99%-Cd) PURATREM	32		Potassium chloride (99.999%-K) PURATREM.....	341
	Cadmium oxide, 99%	32		Potassium chloride, 99+% (ACS)	341
CdO ₄ S	Cadmium sulfate hydrate, 98+% (ACS)	33	ClKO ₃	Potassium chlorate, 99% (ACS).....	341
CdS	Cadmium sulfide (99.9+%-Cd)	33	ClKO ₄	Potassium perchlorate, 99%.....	343
	Cadmium sulfide, 98%	33	ClLi	Lithium chloride, 99% (ACS)	116
	Cadmium sulfide (99.999%-Cd) PURATREM	33		Lithium chloride hydrate (99.996%-Li) PURATREM.....	116
CdSe/CdS	Cadmium selenide/cadmium sulfide CANdot® quantum rod (CdSe/CdS elongated core/shell), 5 mg/ml in hexanes, 560nm peak emission.....	139	ClLiO ₄	Lithium perchlorate trihydrate, 98%.....	118
	Cadmium selenide/cadmium sulfide CANdot® quantum rod (CdSe/CdS elongated core/shell), 5 mg/ml in hexanes, 590nm peak emission.....	139		Lithium perchlorate, anhydrous, 95+% (ACS).....	118
	Cadmium selenide/cadmium sulfide CANdot® quantum rod (CdSe/CdS elongated core/shell), 5 mg/ml in hexanes, 620nm peak emission.....	139	ClNa	Sodium chloride (99.999%-Na) PURATREM	417
	Cadmium selenide (99.999+%-Cd) PURATREM.....	32		Sodium chloride, 99+% (ACS).....	417
			ClNaO ₃	Sodium chlorate, 99%	417
			ClNaO ₄	Sodium perchlorate, anhydrous, 98% (ACS)	420
				Sodium perchlorate monohydrate, 98%	420
			ClO ₄ Rb	Rubidium perchlorate, anhydrous (99.9%-Rb).....	362

Formula Index

Formula	Description	Page
ClRb	Rubidium chloride (99.8%-Rb)	361
	Rubidium chloride (99%-Rb)	361
Cl ₂ Co	Cobalt(II) chloride, anhydrous, 99+%	48
	Cobalt(II) chloride hexahydrate, 98+%	48
	Cobalt(II) chloride hexahydrate (99.999%-Co) PURATREM	48
Cl ₂ CoO ₈	Cobalt(II) perchlorate hexahydrate, 98+%	49
Cl ₂ Cr	Chromium(II) chloride, anhydrous (99.9%-Cr)	45
	Chromyl chloride, 99.5%	46
Cl ₂ CrO ₂	Copper(II) chloride, anhydrous, min. 98%	56
Cl ₂ Cu	Copper(II) chloride dihydrate, 99+% (ACS)	56
	Copper(II) chloride dihydrate (99.999%-Cu) PURATREM	56
	Copper(II) perchlorate hexahydrate, 98+%	57
Cl ₂ CuO ₈	Iron(II) chloride, anhydrous, 98%	107
Cl ₂ Fe	Iron(II) chloride tetrahydrate, 99%	107
Cl ₂ H ₆ N ₂ Pd	trans-Dichlorodiammine palladium(II), 99%	239
Cl ₂ H ₆ N ₂ Pt	cis-Dichlorodiammine platinum(II), 99%	337
	CISPLATIN	337
	trans-Dichlorodiammine platinum(II), 99%	337
Cl ₂ H ₁₂ N ₄ Pt	Tetraammineplatinum(II) chloride monohydrate, 99% (99.95%-Pt)	339
Cl ₂ H ₁₆ N ₄ Ni	Hexaamminenickel(II) chloride, 98%	174
Cl ₂ H ₁₆ N ₆ Ru	Hexaammineruthenium(II) chloride, 98%	397
Cl ₂ HfO	Hafnium(IV) dichloride oxide octahydrate (98+%-Hf, 1.5% Zr)	77
Cl ₂ Hg	Mercury(II) chloride, 99+%	127
Cl ₂ HgO ₈	Mercury(II) perchlorate trihydrate, 99+%	128
Cl ₂ Hg ₂	Mercury(I) chloride, 99.5+% (ACS)	127
Cl ₂ Mg	Magnesium chloride, 97.5% (H ₂ O - 2% max.)	122
	Magnesium perchlorate, reagent (99.9%-Mg)	123
	Magnesium perchlorate hexahydrate, 99%	123
Cl ₂ Mn	Manganese(II) chloride, anhydrous, 97%	126
	Manganese(II) chloride tetrahydrate (99.995%-Mn) PURATREM	126
	Manganese(II) chloride tetrahydrate, 98+% (ACS)	126
Cl ₂ MnO ₈	Manganese(II) perchlorate hexahydrate, 99%	127
Cl ₂ Ni	Nickel(II) chloride hexahydrate (99.999%-Ni) PURATREM	175
	Nickel(II) chloride, anhydrous, 98%	175
	Nickel(II) chloride hexahydrate (99.9+%-Ni)	175
Cl ₂ NiO ₈	Nickel(II) perchlorate hexahydrate, 99%	176
Cl ₂ OSe	Selenium dichloride oxide, 97%	404
Cl ₂ OZr	Zirconium(IV) dichloride oxide hydrate (99.99+%-Zr) PURATREM	457
	Zirconium(IV) dichloride oxide hydrate (99.9%-Zr)	457
Cl ₂ O ₈ Pb	Lead(II) perchlorate, trihydrate, 97+% (ACS)	114
Cl ₂ O ₈ Sr	Strontium perchlorate hydrate (99.9%-Sr)	423
Cl ₂ O ₈ Zn	Zinc perchlorate hexahydrate, 99%	453
Cl ₂ Pb	Lead(II) chloride, 99%	114
Cl ₂ Pd	Palladium(II) chloride (99.9%-Pd)	248
Cl ₂ Pt	Platinum(II) chloride (99.9%-Pt)	338
Cl ₂ Se ₂	Selenium(I) chloride (99%-Se)	404
Cl ₂ Sn	Tin(II) chloride, anhydrous, 98%	436
	Tin(II) chloride dihydrate, 98%	436
Cl ₂ Sr	Strontium chloride, anhydrous, min. 95%	422
	Strontium chloride hexahydrate, 99% (ACS)	423
Cl ₂ Zn	Zinc chloride, anhydrous, min. 97% (ACS)	452
	Zinc chloride (99.99%-Zn) PURATREM	452
	Zinc chloride 2.2M (25wt% ±1wt%) in 2-methyltetrahydrofuran	452
Cl ₃ CoH ₁₈ N ₆	Hexaamminecobalt(III) chloride (99.999%-Co) PURATREM	51
Cl ₃ Cr	Chromium(III) chloride hexahydrate	45
	Chromium(III) chloride, anhydrous (99.9%-Cr)	45
	Chromium(III) chloride, anhydrous, 99%	45
Cl ₃ Dy	Dysprosium(III) chloride, anhydrous (99.9%-Dy) (REO)	60
	Dysprosium(III) chloride hexahydrate (99.9%-Dy) (REO)	60

Formula	Description	Page
Cl ₃ DyO ₁₂	Dysprosium(III) perchlorate, 50% aqueous solution (99.9%-Dy) (REO)	60
Cl ₃ Er	Erbium(III) chloride hydrate (99.999%-Er) (REO) PURATREM	61
	Erbium(III) chloride hydrate (99.999+%-Er) (low Ca, Fe, Mg) PURATREM	61
	Erbium(III) chloride, anhydrous (99.9%-Er) (REO)	61
	Erbium(III) chloride hydrate (99.9%-Er) (REO)	61
Cl ₃ ErO ₁₂	Erbium(III) perchlorate, 50% aqueous solution (99.9%-Er) (REO)	61
Cl ₃ Eu	Europium(III) chloride, anhydrous (99.9%-Eu) (REO)	62
	Europium(III) chloride hexahydrate (99.9%-Eu) (REO)	62
Cl ₃ EuO ₁₂	Europium(III) perchlorate, 50% aqueous solution (99.9%-Eu) (REO)	62
Cl ₃ Fe	Iron(III) chloride hexahydrate, 97+% (ACS)	107
	Iron(III) chloride, anhydrous, 98%	107
Cl ₃ FeO ₁₂	Iron(III) perchlorate hydrate (yellow)	109
	Iron(III) perchlorate hydrate (purple)	109
Cl ₃ Ga	Gallium(III) chloride, anhydrous, granular (99.999%-Ga) PURATREM	68
	Gallium(III) chloride, anhydrous, fused lump (99.999%-Ga) PURATREM	68
Cl ₃ Gd	Gadolinium(III) chloride, anhydrous (99.9%-Gd) (REO)	66
	Gadolinium(III) chloride hydrate (99.9%-Gd) (REO)	66
Cl ₃ GdO ₁₂	Gadolinium(III) perchlorate, 40-50% aqueous solution (99.9%-Gd) (REO)	67
Cl ₃ H ₃ KNP	Potassium trichloroammineplatinate(II)	344
Cl ₃ H ₁₅ N ₅ Rh	Chloropentaamminerhodium(III) chloride, 99%	357
Cl ₃ H ₁₅ N ₅ Ru	Chloropentaammineruthenium(III) chloride, 98%	379
Cl ₃ H ₁₅ N ₆ Ru	Hexaammineruthenium(III) chloride, 99%	397
Cl ₃ Ho	Holmium(III) chloride, anhydrous (99.9%-Ho) (REO)	78
	Holmium(III) chloride hexahydrate (99.9%-Ho) (REO)	78
Cl ₃ In	Indium(III) chloride tetrahydrate (99.99%-In) PURATREM	80
	Indium(III) chloride, anhydrous (99.99%-In) PURATREM	80
Cl ₃ InO ₁₂	Indium(III) perchlorate octahydrate (99.9%-In)	80
Cl ₃ Ir	Iridium(III) chloride hydrate (99.9%-Ir)	92
	Iridium(III) chloride, anhydrous (99.95+%-Ir)	92
Cl ₃ La	Lanthanum(III) chloride hydrate (99.999+%-La) (low Ca, Fe, Mg) PURATREM	112
	Lanthanum(III) chloride hydrate (99.999%-La) (REO) PURATREM	112
	Lanthanum(III) chloride, anhydrous (99.9%-La) (REO)	112
	Lanthanum(III) chloride hexahydrate (99.9%-La) (REO)	112
Cl ₃ LaO ₁₂	Lanthanum(III) perchlorate hexahydrate	113
Cl ₃ Lu	Lutetium(III) chloride, anhydrous (99.9%-Lu) (REO)	119
	Lutetium(III) chloride hexahydrate (99.9%-Lu) (REO)	119
Cl ₃ LuO ₁₂	Lutetium(III) perchlorate, 50% aqueous solution (99.9%-Lu) (REO)	119
Cl ₃ Mo	Molybdenum(III) chloride (99.5%-Mo)	137
Cl ₃ NORu	Ruthenium(III) nitrosyl chloride monohydrate, 99%	398
Cl ₃ Nd	Neodymium(III) chloride hydrate (99.997%-Nd) (REO) PURATREM	169
	Neodymium(III) chloride, anhydrous (99.9%-Nd) (REO)	169
	Neodymium(III) chloride hexahydrate (99.9%-Nd) (REO)	169
Cl ₃ NdO ₁₂	Neodymium(III) perchlorate, 50% aqueous solution (99.9%-Nd) (REO)	170
Cl ₃ OP	Phosphorus oxychloride, 98+%	320
	Phosphorus oxychloride, elec. gr. (99.999%-P) PURATREM	320

Formula Index

Formula	Description	Page	Formula	Description	Page
Cl ₃ O ₁₂ V	Vanadium(V) trichloride oxide, min. 99%.....	446	Cl ₄ H ₁₂ N ₄ Pt ₂	Tetraammineplatinum(II) tetrachloroplatinate(II), 99%	339
Cl ₃ O ₁₂ Pr	Praseodymium(III) perchlorate, 50% aqueous solution (99.9%-Pr) (REO).....	346	Cl ₄ Hf	Hafnium(IV) chloride, sublimed grade (99.9+% -Hf, <1.0% Zr)	77
Cl ₃ O ₁₂ Sm	Samarium(III) perchlorate, 50% aqueous solution (99.9%-Sm) (REO).....	402		Hafnium(IV) chloride, sublimed grade (99.9+% -Hf, <0.05% Zr)	77
Cl ₃ O ₁₂ Tb	Terbium(III) perchlorate, 50% aqueous solution (99.9%-Tb) (REO).....	431	Cl ₄ Ir	Iridium(IV) chloride, hydrate	92
Cl ₃ O ₁₂ Y	Yttrium(III) perchlorate, 50% aqueous solution (99.9%-Y) (REO).....	449	Cl ₄ K ₂ Pd	Potassium tetrachloropalladate(II), 99%.....	344
Cl ₃ O ₁₂ Yb	Ytterbium(III) perchlorate, 50% aqueous solution (99.9%-Yb) (REO).....	448	Cl ₄ K ₂ Pt	Potassium tetrachloroplatinate(II) (99.9%-Pt)	344
Cl ₃ Os	Osmium(III) chloride hydrate	213	Cl ₆ MoO	Molybdenum(VI) tetrachloride oxide, min. 97%	138
	Osmium(III) chloride hydrate (99.95+%-Os) ..	213	Cl ₄ Na ₂ Pd	Sodium tetrachloropalladate(II) trihydrate, 99%	421
Cl ₃ P	Phosphorus(III) chloride (99.998%-P) PURATREM.....	320	Cl ₄ Na ₂ Pt	Sodium tetrachloroplatinate(II) hydrate	421
	Phosphorus(III) chloride, 98+%	320	Cl ₄ OW	Tungsten(VI) oxychloride, 98%	444
Cl ₃ PS	Triphosphoryl chloride, 98%	325	Cl ₄ Pt	Platinum(IV) chloride (99.9%-Pt)	338
Cl ₃ Pr	Praseodymium(III) chloride, anhydrous (99.9%-Pr) (REO)	345	Cl ₄ Se	Selenium(IV) chloride (99.8%-Se).....	404
	Praseodymium(III) chloride heptahydrate (99.9%-Pr) (REO).....	345	Cl ₄ Si	Silicon(IV) chloride, fiber optic grade (99.9999%-Si, 50ppm-Fe) PURATREM	409
Cl ₃ Rh	Rhodium(III) chloride, anhydrous	359		Silicon(IV) chloride, fiber optic grade (99.9999%-Si, 50ppm-Fe) PURATREM, 98-0147, contained in a 50 ml electropolished Swagelok® cylinder (96-1077) for CVD/ALD..	410
	Rhodium(III) chloride hydrate (38-41% Rh)...	359	Cl ₄ Sn	Tin(IV) chloride, anhydrous, 98%	436
Cl ₃ Ru	Ruthenium(III) chloride, anhydrous	398		Tin(IV) chloride pentahydrate, 98%	436
	Ruthenium(III) chloride hydrate (40-43% Ru) (99.9%-Ru)	398		Tin(IV) chloride, anhydrous (99.99%-Sn%) PURATREM.....	436
	Ruthenium(III) chloride hydrate (40-43% Ru) (99.99+%-Ru) PURATREM [free of Ru(II) and Ru(IV) by electrochemical analysis]	398	Cl ₄ Te	Tellurium(IV) chloride (99.9%-Te)	430
Cl ₃ Sb	Antimony(III) chloride (99%-Sb)	8	Cl ₄ Ti	Titanium(IV) chloride, 99%	441
	Antimony(III) chloride, elec. gr. (99.999%-Sb) PURATREM	8		Titanium(IV) chloride, 99%, 22-1150, contained in 50 ml Swagelok® cylinder (96-1070) for CVD/ALD.....	441
Cl ₃ Sc	Scandium (III) chloride, anhydrous (99.99%-Sc) (REO), sublimed, PURATREM.....	403	Cl ₄ W	Tungsten(IV) chloride, 97%	444
	Scandium(III) chloride hexahydrate (99.9%-Sc) (REO)	403	Cl ₄ Zr	Zirconium(IV) chloride, sublimed grade (99.95+%-Zr)	457
Cl ₃ Sm	Samarium(III) chloride, anhydrous (99.9%-Sm) (REO).....	402		Zirconium(IV) chloride (99.5+%-Zr)	457
	Samarium(III) chloride hexahydrate (99.9%-Sm) (REO)	402	Cl ₅ IrKNO	Potassium pentachloronitrosyl iridium(III), 99%	343
Cl ₃ Tb	Terbium(III) chloride hydrate (99.995%-Tb) (REO) PURATREM	431	Cl ₄ K ₂ Ru	Potassium pentachlororuthenate(III) hydrate	343
	Terbium(III) chloride hexahydrate (99.9%-Tb) (REO)	431	Cl ₆ Mo	Molybdenum(V) chloride, anhydrous, 99.6% (REO)	138
	Terbium(III) chloride, anhydrous (99.9%-Tb) (REO)	431	Cl ₅ Nb	Niobium(V) chloride (99.99%-Nb) (20-200ppm Ta) PURATREM.....	177
Cl ₃ Ti	Titanium(III) chloride, Al reduced, 98+%	441		Niobium(V) chloride (99+%-Nb)	177
Cl ₃ Tl	Thulium(III) chloride, anhydrous (99.9%-Tm) (REO)	433	Cl ₅ P	Phosphorus(V) chloride, 98%	320
	Thulium(III) chloride hydrate (99.9%-Tm) (REO)	433	Cl ₅ Re	Rhenium(V) chloride (99.9%-Re)	347
Cl ₃ Tm	Thulium(III) chloride hydrate (99.9%-Tm) (REO)	433	Cl ₅ Sb	Antimony(V) chloride, (99.999%-Sb) PURATREM.....	8
Cl ₃ V	Vanadium(III) chloride, anhydrous, min. 95%	445		Antimony(V) chloride, 99%	8
Cl ₃ Y	Yttrium(III) chloride hexahydrate (99.9%-Y) (REO)	449	Cl ₅ Ta	Tantalum(V) chloride, anhydrous (99.9%-Ta) Tantalum(V) chloride, resublimed (99.99+%-Ta) PURATREM.....	429
	Yttrium(III) chloride, anhydrous (99.9%-Y) (REO)	449	Cl ₆ H ₂ Ir	Dihydrogen hexachloroiridate(IV) hydrate (99.9%-Ir)	91
Cl ₃ Yb	Ytterbium(III) chloride hydrate (99.99+%-Yb) (REO) PURATREM	447	Cl ₆ H ₂ Os	Dihydrogen hexachloroosmate(IV) hexahydrate	213
	Ytterbium(III) chloride hexahydrate (99.9%-Yb) (REO).....	447	Cl ₆ H ₂ Pt	Chloroplatinic acid hexahydrate (38-40% Pt) (99.9%-Pt)	337
Cl ₄ CuH ₈ N ₂	Ammonium copper(II) chloride dihydrate.....	5	Cl ₆ H ₈ IrN ₂	Ammonium hexachloroiridate(IV), 99%	5
Cl ₄ CuLi ₂	Lithium tetrachlorocuprate, 0.1M in THF	118	Cl ₆ H ₈ N ₂ Pd	Ammonium hexachloropalladate(IV), 99+% ..	5
Cl ₄ Ga	Gallium(II) chloride, anhydrous (99.999%-Ga) PURATREM.....	67	Cl ₆ H ₈ N ₂ Pt	Ammonium hexachloroplatinate(IV), 99%	5
Cl ₄ Ge	Germanium(IV) chloride (99.99%-Ge) PURATREM.....	69	Cl ₆ H ₈ N ₂ Ru	Ammonium hexachlororuthenate(IV), 99%....	5
	Germanium(IV) chloride (99.9999%-Ge) PURATREM.....	69	Cl ₆ H ₁₂ IrN ₃	Ammonium hexachloroiridate(III) hydrate (~39% Ir)	5
Cl ₄ H ₆ N ₂ Pt	cis-Tetrachlorodiammine platinum(IV), 99%.. trans-Tetrachlorodiammine platinum(IV), 98%	339	Cl ₆ H ₁₂ N ₃ Rh	Ammonium hexachlororhodate(III) monohydrate (99.995%-Rh) PURATREM	5
	trans-Tetrachlorodiammine platinum(IV), 98%	339		Ammonium hexachlororhodate(III) hydrate ...	5
Cl ₄ H ₈ N ₂ Pd	Ammonium tetrachloropalladate(II) (99.998%-Pd) PURATREM	6	Cl ₆ IrK ₂	Potassium hexachloroiridate(IV), 99%	342
	Ammonium tetrachloropalladate(II), 99%	6	Cl ₆ IrNa ₂	Sodium hexachloroiridate(IV) hexahydrate, 99%	418
Cl ₄ H ₈ N ₂ Pt	Ammonium tetrachloroplatinate(II), 99%	7		Sodium hexachloroiridate(III) hydrate.....	418
Cl ₄ H ₁₂ N ₄ Pd ₂	Tetraammine palladium(II) tetrachloropalladate(II), 99%	248	Cl ₆ IrNa ₃	Potassium hexachlororhodate(IV), 99%	342
			Cl ₆ K ₂ Os	Potassium hexachloroosmate (IV), 99% (99.98+%-Os)	342
			Cl ₆ K ₂ Pd	Potassium hexachloropalladate(IV), 99%.....	342
			Cl ₆ K ₂ Pt	Potassium hexachloroplatinate(IV), 99%.....	342
			Cl ₆ K ₂ Re	Potassium hexachlororhenate(IV) (99.9%-Re).....	342
			Cl ₆ N ₃ P ₃	Phosphonitric chloride trimer, 98.5%	320

Formula Index

Formula	Description	Page
Cl ₆ Na ₂ Os	Sodium hexachloroosmate(IV) hydrate	418
	Sodium hexachloroosmate(IV) hydrate (99.98%-Os)	418
Cl ₆ Na ₂ Pd	Sodium hexachloropalladate(IV), 98+%	418
Cl ₆ Na ₂ Pt	Sodium hexachloroplatinate(IV) hexahydrate, 98+%	418
Cl ₆ Na ₂ Rh	Sodium hexachlororhodate(III) hydrate	418
Cl ₆ W	Tungsten(VI) chloride (99.9%-W)	444
CoCl ₂	Cobalt(II) chloride, anhydrous (99.999%-Co) PURATREM	48
CoF ₂	Cobalt(II) fluoride, anhydrous, 99%	49
CoF ₃	Cobalt(III) fluoride, 99%	49
CoH ₂ O ₂	Cobalt(II) hydroxide (97%-Co)	49
CoI ₂	Cobalt(II) iodide, anhydrous, min. 95% (99.5%-Co)	49
CoLiO ₂	Lithium cobalt(III) oxide, min. 98%	116
CoMoO ₄	Cobalt(II) molybdate, anhydrous (99.9%-Co)	49
CoN ₂ O ₈	Cobalt(II) nitrate hexahydrate, 99% Cobalt(II) nitrate hexahydrate (99.999%-Co) PURATREM	49
CoN ₂ Na ₃ O ₁₂	Sodium hexanitritocobaltate(III), (ACS)	419
CoO	Cobalt oxide-molybdenum oxide on alumina (3.5% CoO, 14% MoO ₃)	49
CoO ₄ S	Cobalt(II) sulfate heptahydrate, 98+% Cobalt(II) sulfate heptahydrate (99.999%-Co) PURATREM	50
CoO ₄ W	Cobalt(II) tungstate (99.9%-Co)	50
CoS	Cobalt(II) sulfide (99.5%-Co)	50
Co ₃ O ₄	Cobalt(II,III) oxide (99.9985%-Co) PURATREM	49
	Cobalt(II,III) oxide, 99.5%	49
Co ₃ O ₈ P ₂	Cobalt(II) phosphate hydrate	50
CrF ₂	Chromium(II) fluoride, anhydrous, 95%	45
CrF ₃	Chromium(III) fluoride, anhydrous, 98%	45
CrLi ₂ O ₄	Lithium chromate, min. 95%	116
CrN ₃ O ₉	Chromium(III) nitrate nonahydrate, 99%	46
CrNa ₂ O ₄	Sodium chromate tetrahydrate, 99+%	417
CrO ₃	Chromium(VI) oxide, 99.5%	46
Cr ₂ CuO ₄	Copper chromite, barium promoted (62-64% Cr ₂ CuO ₄ , 22-24% CuO, 6%BaO, 0-4% Graphite, 1% CrO ₃ , 1% Cr ₂ O ₃)	56
Cr ₂ K ₂ O ₇	Potassium dichromate, 99+ (ACS)	341
Cr ₂ O ₃	Chromium(III) oxide hydrate, 98% Chromium(III) oxide, 98% Chromium(III) oxide, 99%	46
Cr ₂ O ₁₂ S ₃	Chromium(III) sulfate hydrate	46
CsF	Cesium fluoride (99.9%-Cs)	43
	Cesium fluoride (99+%-Cs)	43
CsHO	Cesium hydroxide, 50% aqueous solution (99.9%-Cs)	43
	Cesium hydroxide, hydrate (99.9%-Cs)	43
CsI	Cesium iodide (99.9%-Cs) Cesium iodide (99.999%-Cs) PURATREM	43
	Cesium iodide (99%-Cs)	43
CsNO ₃	Cesium nitrate (99.9%-Cs) PURATREM	44
	Cesium nitrate (99.9%-Cs)	44
Cs ₂ O ₄ S	Cesium sulfate (99.9%-Cs)	44
CuF ₂	Copper(II) fluoride, anhydrous, 99%	56
CuH ₁₂ N ₄ O ₈ S	Tetraamminecopper(II) sulfate hydrate	59
CuI	Copper(I) iodide (99.999%-Cu) PURATREM Copper(I) iodide, 98% Copper(I) iodide/cesium carbonate admixture [5.50 wt% CuI]	57
CuN ₂ O ₈	Copper(II) nitrate trihydrate, 99.5% Copper(II) nitrate trihydrate (99.999%-Cu) PURATREM	57
CuO	Copper(II) oxide (99.995%-Cu) PURATREM Copper(II) oxide (99.5+%-Cu) Copper(II) oxide, min. 97% (99+%-Cu)	57
CuO ₄ S	Copper(II) sulfate, anhydrous, 98% Copper(II) sulfate pentahydrate, 98+ (ACS) Copper(II) sulfate pentahydrate (99.999%-Cu) PURATREM	58
	Copper(II) sulfate pentahydrate (99.999%-Cu) PURATREM	58
CuS	Copper(II) sulfide (99.5%-Cu)	58
Cu ₂ O	Copper(I) oxide, min. 95%	57
	Copper(I) oxide (99.9%-Cu)	57
Cu ₂ S	Copper(I) sulfide (99.5%-Cu)	58

Formula	Description	Page
DLi	Lithium deuteride, 99+% isotopic purity	116
DyF ₃	Dysprosium(III) fluoride, anhydrous (99.9%-Dy) (REO)	60
DyN ₃ O ₉	Dysprosium(III) nitrate hexahydrate (99.9%-Dy) (REO)	60
Dy ₂ O ₃	Dysprosium(III) oxide (99.9%-Dy) (REO) Dysprosium(III) oxide (99.998%-Dy) (REO) PURATREM	60
ErI ₃	Erbium(III) iodide, anhydrous (99.9%-Er) (REO)	61
ErN ₃ O ₉	Erbium(III) nitrate hydrate (99.9%-Er) (REO)	61
Er ₂ O ₃	Erbium(III) oxide (99.9%-Er) (REO) Erbium(III) oxide (99.995%-Er) (REO) PURATREM	61
EuF ₃	Europium(III) fluoride, anhydrous (99.99%-Eu) (REO) PURATREM	62
EuN	Europium nitride (99.9%-Eu)	62
EuN ₃ O ₉	Europium(III) nitrate hexahydrate (99.9%-Eu) (REO)	62
Eu ₂ O ₃	Europium(III) oxide (99.9%-Eu) (REO) PURATREM	62
Eu ₂ O ₁₂ S ₃	Europium(III) sulfate octahydrate (99.99%-Eu) (REO) PURATREM	63
	Europium(III) sulfate octahydrate (99.9%-Eu) (REO)	62
FH ₂ O ₃ P	Fluorophosphoric acid, 60-70%	313
FH ₃ N	Ammonium fluoride, 98+ (ACS)	5
FK	Potassium fluoride dihydrate, 98%	341
	Potassium fluoride, anhydrous (99.97%-K)	341
	Potassium fluoride, anhydrous, 98%	341
FLi	Lithium fluoride (99.9%-Li) Lithium fluoride, 99.9% (99.9+%-Li) Lithium fluoride, 99+%	117
	Lithium fluoride, 99+%	117
FNa	Sodium fluoride (99.99+%-Na) PURATREM	418
	Sodium fluoride, 99% (ACS)	418
FN ₂ O ₃ P	Sodium fluorophosphate, 94%	418
FRb	Rubidium fluoride, anhydrous (99.8%-Rb)	362
FTl	Thallium(I) fluoride, 99%	432
F ₂ Fe	Iron(II) fluoride, anhydrous, 99%	107
F ₂ HK	Potassium hydrogen fluoride, 99+%	342
F ₂ HO ₂ P	Difluorophosphoric acid hemihydrate, tech. gr.	297
F ₂ Hg	Mercury(II) fluoride, 98%	127
F ₂ Hg ₂	Mercury(I) fluoride, 95+%	127
F ₂ KNO ₄ S ₂	Potassium bis(fluorosulfonyl)imide, 98%	340
F ₂ Mg	Magnesium fluoride, 99% Magnesium fluoride (99.99+%-Mg) PURATREM	122
	PURATREM	122
F ₂ Mn	Manganese(II) fluoride, 99%	126
F ₂ Ni	Nickel(II) fluoride tetrahydrate, 98+% Nickel(II) fluoride, anhydrous, 99%	175
	Nickel(II) fluoride, anhydrous, 99%	175
F ₂ Pb	Lead(II) fluoride, 99+%	114
F ₂ Sn	Tin(II) fluoride, 97.5%	436
F ₂ Sr	Strontium fluoride (99.99%-Sr) PURATREM Strontium fluoride, reagent, 99%	423
	Strontium fluoride, reagent, 99%	423
F ₂ Xe	Xenon(II) fluoride, 99.5%	446
F ₂ Zn	Zinc fluoride, anhydrous, 99%	452
	Zinc fluoride tetrahydrate, 98%	452
F ₃ Fe	Iron(III) fluoride, anhydrous, 99+% Iron(III) fluoride trihydrate, 98%	107
	Iron(III) fluoride trihydrate, 98%	108
F ₃ Ga	Gallium(III) fluoride trihydrate, 99.5%	68
F ₃ GaH ₆ O ₃	Gallium (III) fluoride trihydrate (99.99%-Ga) PURATREM	68
F ₃ Gd	Gadolinium(III) fluoride, anhydrous (99.9%-Gd) (REO)	67
F ₃ In	Indium(III) fluoride, anhydrous, 98%	80
F ₃ La	Lanthanum(III) fluoride, anhydrous (99.99%-La) (REO) PURATREM	112
	Lanthanum(III) fluoride, anhydrous (99.9%-La) (REO)	112
	Lanthanum(III) fluoride, 98%	126
F ₃ Mn	Manganese(III) fluoride, 98%	169
F ₃ Nd	Neodymium(III) fluoride, anhydrous (99.9%-Nd) (REO)	169
F ₃ OV	Vanadium(V) trifluoride oxide, 98+%	446
F ₃ Pr	Praseodymium(III) fluoride (99.9%-Pr) (REO)	345
F ₃ Sb	Antimony(III) fluoride, 98%	9
F ₃ Sc	Scandium(III) fluoride (99.9%-Sc) (REO)	403

Formula Index

Formula	Description	Page	Formula	Description	Page
F ₃ Sm	Samarium(III) fluoride (99.9%-Sm) (REO).....	402	GdN ₃ O ₉	Gadolinium(III) nitrate hexahydrate (99.9%-Gd) (REO)	67
F ₃ Ti	Titanium(III) fluoride, min. 98%	442	Gd ₂ O ₃	Gadolinium(III) oxide (99.99%-Gd) (REO) PURATREM.....	67
F ₃ Y	Yttrium(III) fluoride (99.9%-Y) (REO).....	449	Gd ₂ O ₁₂ S ₃	Gadolinium(III) sulfate octahydrate (99.9%-Gd) (REO)	67
F ₃ Yb	Ytterbium(III) fluoride (99.99%-Yb) (REO) PURATREM.....	447	Gel ₂	Germanium(II) iodide (99.99+%-Ge) PURATREM.....	69
F ₄ Sn	Tin(IV) fluoride, 98.5%	436	Gel ₄	Germanium(IV) iodide (99.999%-Ge) PURATREM.....	69
F ₄ Th	Thorium(IV) fluoride, anhydrous (99.9%-Th) ..	433	GeO ₂	Germanium(IV) oxide (99.999%-Ge) PURATREM.....	69
F ₄ Ti	Titanium(IV) fluoride, 98%	442	F ₆ Nb	Niobium(V) fluoride, 99.5%	177
F ₄ Zr	Zirconium(IV) fluoride, 98%	458	F ₆ Ta	Tantalum(V) fluoride, 99.5%	429
	Zirconium(IV) fluoride (99.9%-Zr).....	458	F ₆ GeH ₈ N ₂	Ammonium hexafluorogermanate, 99%	6
		177	F ₆ HP	Hexafluorophosphoric acid, 60-70% in water	313
F ₆ Nb	Niobium(V) fluoride, 99.5%	177	F ₆ HSb	Hydrogen hexafluoroantimonate(V), 65-70% aqueous solution	9
F ₆ Ta	Tantalum(V) fluoride, 99.5%	429	F ₆ H ₂ Ti	Hexafluorotitanic acid, 60% aqueous solution	440
F ₆ GeH ₈ N ₂	Ammonium hexafluorogermanate, 99%	6	F ₆ H ₄ NP	Ammonium hexafluorophosphate, 99%.....	6
F ₆ HP	Hexafluorophosphoric acid, 60-70% in water	313	F ₆ H ₈ N ₂ Si	Ammonium hexafluorosilicate, min. 98%.....	6
F ₆ HSb	Hydrogen hexafluoroantimonate(V), 65-70% aqueous solution	9	F ₆ H ₈ N ₂ Ti	Ammonium hexafluorotitanate(IV), min. 98%	6
F ₆ H ₂ Ti	Hexafluorotitanic acid, 60% aqueous solution	440	F ₆ KP	Potassium hexafluorophosphate, 99.5%	342
F ₆ H ₄ NP	Ammonium hexafluorophosphate, 99%.....	6	F ₆ K ₂ P	Potassium hexafluoronickelate(IV), 99%.....	342
F ₆ H ₈ N ₂ Si	Ammonium hexafluorosilicate, min. 98%.....	6	F ₆ K ₃ Ni	Potassium hexafluorosilicate, 99%	342
F ₆ H ₈ N ₂ Ti	Ammonium hexafluorotitanate(IV), min. 98%	6	F ₆ LiP	Lithium hexafluorophosphate (99.9+%-Li).....	117
F ₆ KP	Potassium hexafluorophosphate, 99.5%	342		Lithium hexafluorophosphate, 99+%	117
F ₆ K ₂ P	Potassium hexafluoronickelate(IV), 99%.....	342	F ₆ LiSb	Lithium hexafluoroantimonate, min. 97%	117
F ₆ K ₃ Ni	Potassium hexafluorosilicate, 99%	342	F ₆ Li ₂ Sn	Lithium hexafluorostannate(IV), 99%	117
F ₆ LiP	Lithium hexafluorophosphate (99.9+%-Li).....	117	F ₆ MgSi	Magnesium hexafluorosilicate hexahydrate, 98%	122
	Lithium hexafluorophosphate, 99+%	117	F ₆ NOP	Nitrosonium hexafluorophosphate, min. 97% ..	204
F ₆ LiSb	Lithium hexafluoroantimonate, min. 97%	117	F ₆ NOSb	Nitrosonium hexafluoroantimonate, min. 97%	204
F ₆ Li ₂ Sn	Lithium hexafluorostannate(IV), 99%	117	F ₆ NO ₂ P	Nitronium hexafluorophosphate, min. 97%....	204
F ₆ MgSi	Magnesium hexafluorosilicate hexahydrate, 98%	122	F ₆ NO ₂ Sb	Nitronium hexafluoroantimonate, min. 97%....	204
F ₆ NOP	Nitrosonium hexafluorophosphate, min. 97% ..	204	F ₆ NaP	Sodium hexafluorophosphate, 99%.....	418
F ₆ NOSb	Nitrosonium hexafluoroantimonate, min. 97%	204	F ₆ NaSb	Sodium hexafluoroantimonate(V), 99%	418
F ₆ NO ₂ P	Nitronium hexafluorophosphate, min. 97%....	204	F ₆ Na ₂ Si	Sodium hexafluorosilicate, 99%	418
F ₆ NO ₂ Sb	Nitronium hexafluoroantimonate, min. 97%....	204	F ₆ Na ₂ Sn	Sodium hexafluorostannate(IV), 99%	418
F ₆ NaP	Sodium hexafluorophosphate, 99%.....	418	F ₆ Na ₂ Ti	Sodium hexafluorotitanate(IV), 98%	419
F ₆ NaSb	Sodium hexafluoroantimonate(V), 99%	418	F ₆ PTi	Thallium(I) hexafluorophosphate, min. 97% ..	432
F ₆ Na ₂ Si	Sodium hexafluorosilicate, 99%	418	FeHO ₂	Iron(III) oxyhydroxide in water at pH = 3.0 + 0.5 (FEO-W320)	159
F ₆ Na ₂ Sn	Sodium hexafluorostannate(IV), 99%	418	FeH ₄ N ₂ O ₆ S ₂	Iron(II) sulfamate, (38-42%) aqueous solution.....	109
F ₆ Na ₂ Ti	Sodium hexafluorotitanate(IV), 98%	419	FeH ₈ N ₂ O ₈ S ₂	Ammonium iron(II) sulfate hexahydrate, 98.5+% (ACS)	6
F ₆ PTi	Thallium(I) hexafluorophosphate, min. 97% ..	432	FeN ₃ O ₉	Iron(III) nitrate nonahydrate, 98+%	108
FeHO ₂	Iron(III) oxyhydroxide in water at pH = 3.0 + 0.5 (FEO-W320)	159		Iron(III) nitrate nonahydrate (99.999%-Fe) PURATREM.....	108
FeH ₄ N ₂ O ₆ S ₂	Iron(II) sulfamate, (38-42%) aqueous solution.....	109	FeO ₄ P	Iron(III) phosphate hydrate	109
FeH ₈ N ₂ O ₈ S ₂	Ammonium iron(II) sulfate hexahydrate, 98.5+% (ACS)	6	FeO ₄ S	Iron(II) sulfate heptahydrate, 99+% (ACS)	109
FeN ₃ O ₉	Iron(III) nitrate nonahydrate, 98+%	108	FeS	Iron(II) sulfide (99.9%-Fe).....	109
	Iron(III) nitrate nonahydrate (99.999%-Fe) PURATREM.....	108		Iron(II) sulfide (99%-Fe).....	109
FeO ₄ P	Iron(III) phosphate hydrate	109	FeS ₂	Iron disulfide (Iron pyrite), 95%.....	107
FeO ₄ S	Iron(II) sulfate heptahydrate, 99+% (ACS)	109	FeSi ₂	Iron silicide, 99%	109
FeS	Iron(II) sulfide (99.9%-Fe).....	109	Fe ₂ O ₃	Iron(III) oxide (99.995%-Fe) PURATREM	108
	Iron(II) sulfide (99%-Fe).....	109		Iron(III) oxide, red (Hematite) (99.8%-Fe)	108
FeS ₂	Iron disulfide (Iron pyrite), 95%.....	107		Iron(III) oxide monohydrate, yellow (99.9+%-Fe)	108
FeSi ₂	Iron silicide, 99%	109	Fe ₂ O ₁₂ S ₃	Iron(III) sulfate hydrate, tech. gr.....	109
Fe ₂ O ₃	Iron(III) oxide (99.995%-Fe) PURATREM	108	Fe ₃ O ₄	Iron(II,III) oxide, black (Magnetite), min. 95% ..	108
	Iron(III) oxide, red (Hematite) (99.8%-Fe)	108		Iron(II,III) oxide (Magnetite) aqueous magnetic fluid [3.5 vol%, Ms = 15-16 kA/m]	158
	Iron(III) oxide monohydrate, yellow (99.9+%-Fe)	108	Ga ₃	Gallium(III) iodide, anhydrous, 99%	68
Fe ₂ O ₁₂ S ₃	Iron(III) sulfate hydrate, tech. gr.....	109	GaN ₃ O ₉	Gallium(III) nitrate hydrate (99.99%-Ga) PURATREM.....	68
Fe ₃ O ₄	Iron(II,III) oxide, black (Magnetite), min. 95% ..	108	GaP	Gallium phosphide (99.999%-Ga) PURATREM	68
	Iron(II,III) oxide (Magnetite) aqueous magnetic fluid [3.5 vol%, Ms = 15-16 kA/m]	158		Gallium(III) oxide (99.998%-Ga) PURATREM	68
	Iron(II,III) oxide (Magnetite) aqueous magnetic fluid [7.0 vol%, Ms = 30-31 kA/m]	158	Ga ₂ O ₃	Gallium(III) oxide (99.998%-Ga) PURATREM	68
Ga ₃	Gallium(III) iodide, anhydrous, 99%	68	Ga ₂ O ₁₂ S ₃	Gallium(III) sulfate hydrate (99.999%-Ga) PURATREM.....	68
GaN ₃ O ₉	Gallium(III) nitrate hydrate (99.99%-Ga) PURATREM.....	68	GdH ₃ O ₃	Gadolinium(III) hydroxide hydrate (99.9%-Gd) (REO)	67
GaP	Gallium phosphide (99.999%-Ga) PURATREM	68			
Ga ₂ O ₃	Gallium(III) oxide (99.998%-Ga) PURATREM	68	GdN ₃ O ₉	Gadolinium(III) nitrate hexahydrate (99.9%-Gd) (REO)	67
Ga ₂ O ₁₂ S ₃	Gallium(III) sulfate hydrate (99.999%-Ga) PURATREM.....	68	Gd ₂ O ₃	Gadolinium(III) oxide (99.99%-Gd) (REO) PURATREM.....	67
			Gd ₂ O ₁₂ S ₃	Gadolinium(III) sulfate octahydrate (99.9%-Gd) (REO)	67
			Gel ₂	Germanium(II) iodide (99.99+%-Ge) PURATREM.....	69
			Gel ₄	Germanium(IV) iodide (99.999%-Ge) PURATREM.....	69
			GeO ₂	Germanium(IV) oxide (99.999%-Ge) PURATREM.....	69
			GeS	Germanium(II) sulfide (99.99+%-Ge) (contains 1-5% germanium metal) PURATREM...	69
			GeSe ₂	Germanium(IV) selenide (99.999%-Ge) PURATREM.....	69
			HK	Potassium hydride, 30-35% in oil	342
			HKO	Potassium hydroxide, pellets, 85+% (ACS)...	343
			HKS	Potassium hydrogen sulfide, anhydrous, min. 95%.....	342
			HK ₂ O ₄ P	Potassium hydrogen phosphate, 98+% (ACS).....	342
			HLi	Lithium hydride, min. 95%	117
			HLiO	Lithium hydroxide monohydrate, min. 98% ...	117
			HNa	Lithium hydroxide, anhydrous, 95%	117
			HNaO	Sodium hydride, 60% in oil.....	419
			HNaO	Sodium hydroxide, pellets, 97+% (ACS)	419
			HNb	Sodium hydroxide monohydrate (99.996%-Na) PURATREM	419
			HNb	Sodium hydrogen sulfide, anhydrous	419
			HNb ₂ O ₄ P	Sodium hydrogen phosphate, 99+% (ACS) ..	419
			HORb	Rubidium hydroxide, 50% aqueous solution (99+%-Rb)	362
			HO ₂ Re	Rubidium hydroxide hydrate, fused solid (99+%-Rb)	362
			H ₂ LiN	Perrhenic acid, aqueous solution (50-54% Re) (99.99%-Re) PURATREM	347
			H ₂ KO ₄ P	Potassium dihydrogen phosphate, 99+% (ACS).....	341
			H ₂ LiN	Lithium amide, 95%.....	116
			H ₂ LiO ₄ P	Lithium dihydrogen phosphate, 97%	116
			H ₂ MgO ₃	Magnesium hydroxide, 95%	122
			H ₂ NaPO ₄	Sodium dihydrogen phosphate monohydrate (99.9%-Na)	417
			H ₂ O ₂ Ni	Nickel(II) hydroxide.....	175
			H ₂ O ₂ Sr	Strontium hydroxide octahydrate, tech. gr.	423
			H ₂ O ₂ Se	Selenous acid (99.999%-Se) PURATREM....	404
			H ₂ O ₃ Si	Silica gel, large pore	409
				Silica gel, 6-16 mesh (indicating).....	409
				Silica gel, 12-24 mesh (liquid drying).....	409
				Silica gel, 70-200 mesh (TLC).....	409
			H ₂ O ₃ Te	Selenic acid, 40% solution.....	404
			H ₂ O ₃ Te	Telluric acid (99.5%-Te)	430
			H ₂ O ₄ W	Tungstic acid, 99%	444
			H ₂ Sr	Strontium hydride (99.5%-Sr)	423
			H ₂ Ti	Titanium(II) hydride, min. 95% (99+%-Ti)	442
			H ₃ LaO ₃	Lanthanum(III) hydroxide, anhydrous (99.9%-La) (REO)	112
			H ₃ Mo ₁₂ O ₄₀ P	12-Molybdophosphoric acid hydrate (ACS)...	138
			H ₃ O ₄ P	Phosphoric acid (ACS), 85%	320
			H ₃ O ₉ P ₃	Polyphosphoric acid (83% P ₂ O ₅)	320
			H ₃ O ₄₀ PW ₁₂	12-Tungstophosphoric acid hydrate, 99+% ...	444
			H ₄ IN	Ammonium iodide (99.999%) PURATREM ...	6
			H ₄ Mo ₁₂ O ₄₀ Si	12-Molybdosilicic acid hydrate.....	138
			H ₄ NO ₃ V	Ammonium metavanadate (99.995%-V) PURATREM.....	6
			H ₄ NO ₄ Re	Ammonium metavanadate, 99%	6
				Ammonium perchlorate (99.999%-Re) PURATREM.....	6
				Ammonium perchlorate, 99+%.....	6
			H ₄ N ₂ O ₃	Ammonium nitrate, 99.5%	6
			H ₄ O ₂ PtS ₂	Platinum sulfite acid solution (15.3% Pt)	338
			H ₅ F ₂ N	Ammonium hydrogen fluoride, min. 96% (contains 3-4% NH ₃ F).....	6
			H ₆ NO ₄ P	Ammonium dihydrogen phosphate, 98+% (ACS).....	5

Formula Index

Formula	Description	Page
	Ammonium dihydrogen phosphate (99.998%) PURATREM.....	5
H ₈ N ₄ O ₄ Pd	Diamminepalladium(II) nitrite solution (5% Pd).....	236
H ₈ N ₄ O ₄ Pt	Diammineplatinum(II) nitrite, solution in ammonium hydroxide (5.0wt% as Pt).....	337
H ₈ MoN ₂ S ₄	Ammonium tetrahiomolybdate(VI), 99% (99.99%-Mo) PURATREM.....	7
H ₈ Mo ₂ N ₂ O ₇	Ammonium dimolybdate, 99%.....	5
H ₈ N ₂ O ₃ S	Ammonium sulfate, 99+% (ACS).....	6
H ₈ N ₂ S	Ammonium sulfide, 40-44% aqueous solution.....	6
	Ammonium sulfide, 20% aqueous solution....	6
H ₈ N ₂ S ₄ W	Ammonium tetrathiotungstate(VI), 99% (99.9+-W).....	7
H ₂ O ₈ Pt	Dihydrogen hexahydroxyplatinate(IV), 99%..	337
H ₉ N ₂ O ₄ P	Ammonium hydrogen phosphate, 98+% (ACS).....	6
H ₁₂ Mo ₁₂ N ₃ O ₄₀ P	Ammonium phosphomolybdate hydrate, reagent.....	6
H ₁₂ N ₆ O ₆ Pd	Tetraamminepalladium(II) nitrate solution (5.0 wt% as Pd).....	248
H ₁₂ N ₆ O ₆ Pt	Tetraammineplatinum(II) nitrate, 99%.....	339
H ₁₄ N ₄ O ₃ Pt	Tetraammineplatinum(II) hydroxide hydrate (59% Pt).....	339
H ₁₈ 1 ₂ N ₆ Ni	Hexaamminenickel(II) iodide, 98%.....	174
H ₂₄ Mo ₇ N ₆ O ₂₄	Ammonium molybdate tetrahydrate (99.98%-Mo).....	6
	Ammonium molybdate tetrahydrate (99.999%-Mo) PURATREM.....	6
	Ammonium molybdate tetrahydrate (ACS)....	6
H ₂₆ N ₆ O ₄₀ W ₁₂	Ammonium metatungstate hydrate (99.94%-W).....	6
H ₄₀ N ₁₀ O ₄₁ W ₁₂	Ammonium tungstate pentahydrate (99.996%-W) PURATREM.....	7
HfO ₂	Hafnium(IV) oxide (99.995%-Hf, <0.15% Zr) PURATREM.....	77
	Hafnium(IV) oxide, 98%.....	77
HgI ₂	Mercury(II) iodide, anhydrous (99.999%-Hg) PURATREM.....	127
	Mercury(II) iodide, 99+% (ACS).....	127
HgNO ₃	Mercury(II) nitrate hydrate, 98+%.....	127
HgN ₂ O ₈	Mercury(II) nitrate monohydrate, 98+% (ACS).....	127
HgO	Mercury(II) oxide, yellow, 99+% (ACS).....	128
	Mercury(II) oxide, red, 99+% (ACS).....	128
HgO ₄ S	Mercury(II) sulfate, min. 98%.....	128
HgSe	Mercury(II) selenide (99.99%-Hg) PURATREM.....	128
HoN ₃ O ₉	Holmium(III) nitrate hydrate (99.9%-Ho) (REO).....	79
Ho ₂ O ₃	Holmium(III) oxide (99.9%-Ho) (REO).....	79
IK	Potassium iodide, 99+% (ACS).....	343
	Potassium iodide (99.99%-K) PURATREM... ..	343
ILi	Lithium iodide trihydrate, 99+%.....	117
	Lithium iodide, anhydrous, min. 98%.....	117
INa	Sodium iodide, anhydrous, 99% (H ₂ O < 1%).....	419
IRb	Rubidium iodide (99.8%-Rb).....	362
	Rubidium iodide, 99%.....	362
ITl	Thallium(I) iodide (99.999%-Tl) PURATREM.....	432
I ₂ Mn	Manganese(II) iodide, anhydrous, 98+%.....	126
I ₂ Ni	Nickel(II) iodide, anhydrous (99.5%-Ni).....	175
	Nickel(II) iodide hydrate.....	175
I ₂ O ₅	Iodine(V) oxide, 99%.....	81
I ₂ Pb	Lead(II) iodide (99.999%-Pb) PURATREM.....	114
	Lead(II) iodide, 98.5%.....	114
I ₂ Pd	Palladium(II) iodide, 99%.....	248
I ₂ Pt	Platinum(II) iodide, min. 98%.....	338
I ₂ Sm	Samarium(II) iodide, 0.1M in THF.....	402
I ₂ Sn	Tin(II) iodide, 99%.....	437
I ₂ Zn	Zinc iodide, 98+%.....	453
I ₃ In	Indium(III) iodide (99.999%-In) PURATREM.....	80
I ₃ La	Lanthanum(III) iodide, anhydrous (99.9%-La) (REO).....	112
I ₃ Nd	Neodymium(III) iodide, anhydrous (99.9%-Nd).....	170
I ₃ Rh	Rhodium(III) iodide (99.94%-Rh).....	359
I ₃ Ru	Ruthenium(III) iodide, anhydrous, 98+%.....	398

Formula	Description	Page
I ₃ Sb	Antimony(III) iodide (99.9%-Sb).....	9
I ₃ Si	Silicon(IV) iodide (99.9%-Si).....	410
I ₃ Sn	Tin(IV) iodide, 95%.....	437
I ₄ Te	Tellurium(IV) iodide (99.9%-Te).....	430
I ₄ Ti	Titanium(IV) iodide (99.99%-Ti) PURATREM.....	442
I ₄ Zr	Zirconium(IV) iodide (99.5%-Zr).....	458
InN ₃ O ₉	Indium(III) nitrate hydrate (99.999%-In) PURATREM.....	80
InP	Indium(III) phosphide (99.999%-In) PURATREM.....	80
InSb	Indium(III) antimonide (99.99%-In) PURATREM.....	79
In ₂ O ₃	Indium(III) oxide (99.998%-In) PURATREM..	80
In ₂ O ₁₂ S ₃	Indium(III) sulfate hydrate (99.999%-In) PURATREM.....	80
In ₂ S ₃	Indium(III) sulfide (99.99%-In) PURATREM..	80
IrCl ₃	Iridium(III) chloride, hydrate (99.994%-Ir) PURATREM [free of Ir(IV) by electrochemical analysis].....	92
IrO ₂	Iridium(IV) oxide, 99% (99.94%-Ir).....	92
KNO ₃	Potassium nitrate, 99+% (ACS).....	343
	Potassium nitrate (99.999%-K) PURATREM.....	343
KNbO ₃	Potassium niobate (99.999%-Nb) PURATREM.....	343
KO ₂	Potassium superoxide, min. 96%.....	344
KO ₃ P	Potassium metaphosphate, 98%.....	343
KO ₄ Re	Potassium perrhenate (99%-Re).....	343
KO ₄ Ru	Potassium perrhenate, 98%.....	343
K ₂ N ₂ O ₈ Pt	Potassium tetranioplatinate(II), min. 98%....	344
K ₂ O ₂ Se	Potassium selenite.....	344
K ₂ O ₃ Te	Potassium tellurite(IV) hydrate, 97%.....	344
K ₂ O ₄ Os	Potassium osmate(VI) dihydrate, 99%.....	343
	Potassium osmate(VI) dihydrate, 99% (99.984%-Os).....	343
K ₂ O ₄ S	Potassium sulfate, 99+% (ACS).....	344
	Potassium sulfate (99.999%-K) PURATREM.....	344
K ₂ O ₄ W	Potassium tungstate (99.5%-W).....	345
K ₂ S	Potassium sulfide, anhydrous, min. 95%.....	344
K ₃ H ₃ O ₁₈ S ₄	Potassium monoperoxydisulfate OXONE®.....	343
K ₃ N ₆ O ₁₂ Rh	Potassium hexanitrorhodate(III), min. 97%..	342
K ₃ O ₄ P	Potassium phosphate, anhydrous, min. 97%.....	344
K ₄ O ₁₀ P ₃	Potassium triphosphate, 94%.....	345
LaN ₃ O ₉	Lanthanum(III) nitrate hexahydrate (99.999%-La) (REO) PURATREM.....	112
	Lanthanum(III) nitrate hexahydrate (99.9%-La) (REO).....	112
	Lanthanum(III) nitrate hexahydrate (99.99%-La) (REO) PURATREM.....	112
LaO ₄ P	Lanthanum(III) phosphate hydrate.....	113
La ₂ O ₃	Lanthanum(III) oxide (99.99%-La) (REO) PURATREM.....	112
	Lanthanum(III) oxide (99.9%-La) (REO).....	112
	Lanthanum(III) oxide (99.999%-La) (REO) PURATREM.....	112
La ₂ O ₁₂ S ₃	Lanthanum(III) sulfate hydrate (99.9%-La) (REO).....	113
La ₂ S ₃	Lanthanum(III) sulfide (99.9%-La) (REO).....	113
La ₃ La	Lanthanum(III) bromide, anhydrous (99.99%-La) (REO) PURATREM.....	112
LiNO ₃	Lithium nitrate, anhydrous, 99%.....	118
LiNbO ₃	Lithium niobate (99.998%-Nb) PURATREM... ..	118
LiO ₃ Ta	Lithium tantalate (99.998%-Ta) PURATREM.....	118
Li ₂ MoO ₄	Lithium molybdate, 99%.....	117
Li ₂ O	Lithium oxide, min. 95% (99.5%-Li).....	118
Li ₂ O ₂ Si	Lithium metasilicate, 99%.....	117
Li ₂ O ₄ W	Lithium tungstate, 98%.....	119
Li ₂ S	Lithium sulfide, 98% (99.9%-Li).....	118
Li ₃ N	Lithium nitride (99.5%-Li).....	118
Li ₃ O ₃ P	Lithium orthophosphate, 98%.....	118
LuN ₃ O ₉	Lutetium(III) nitrate hydrate (99.9%-Lu) (REO).....	119
Lu ₂ O ₃	Lutetium(III) oxide (99.9%-Lu) (REO).....	119
	Lutetium(III) oxide (99.999%-Lu) (REO) PURATREM.....	119
Lu ₂ O ₁₂ S ₃	Lutetium(III) sulfate hydrate (99.9%-Lu) (REO).....	119
MgMoO ₄	Magnesium molybdate (99.9%-Mo).....	122

Formula Index

Formula	Description	Page
MgN ₂ O ₆	Magnesium nitrate hexahydrate (99.999%-Mg) PURATREM	122
	Magnesium nitrate hexahydrate, 99% (ACS)	122
MgO	Magnesium oxide (99.99+%-Mg) PURATREM	122
	Magnesium oxide, -325 mesh (99.95%-Mg)..	122
	Magnesium oxide, -325 mesh (99.5%-Mg)....	122
	Magnesium oxide, -325 mesh, 98%	122
	Magnesium oxide nanopowder.....	161
MgO ₃ Ti	Magnesium titanate, tech. gr., (~85%).....	123
MgO ₄ S	Magnesium sulfate, anhydrous, 99+%	123
	Magnesium sulfate heptahydrate, 98+% (ACS).....	123
MgO ₄ W	Magnesium tungstate (99.9%-W).....	123
Mg ₂ Si	Magnesium silicide (99.5%-Mg) (C < 1%).....	123
MnCl ₂	Manganese(II) chloride anhydrous (99.995%-Mn) PURATREM.....	126
MnMoO ₄	Manganese(II) molybdate (99.9%-Mo).....	126
MnN ₂ O ₆	Manganese(II) nitrate, 50-52% aqueous solution	126
MnO	Manganese(II) oxide, 99%.....	126
MnO ₂	Manganese(IV) oxide, 99+%	126
	Manganese(IV) oxide, activated	126
	Manganese(IV) oxide (99.995%-Mn) PURATREM.....	126
MnS	Manganese(II) sulfide (99.9%-Mn)	127
MnSe	Manganese(II) selenide (99.9%-Mn)	127
Mn ₂ O ₃	Manganese(III) oxide, 99%	126
Mn ₃ O ₄	Manganese(II,III) oxide, 97%	126
MoNa ₂ O ₄	Sodium molybdate dihydrate, 99.5% (ACS)..	419
	Sodium molybdate, anhydrous, 98+%.....	419
	Sodium molybdate dihydrate, 99%.....	419
MoO ₃	Molybdenum(IV) oxide, 99%	138
MoO ₃	Molybdenum(VI) oxide (99.998%-Mo) PURATREM	138
	Molybdenum(VI) oxide (99.998%-Mo) PURATREM.....	138
	Molybdenum(VI) oxide, 99.5+%	138
MoO ₃ Zn	Zinc molybdate, 98+%	453
MoS ₂	Molybdenum(IV) sulfide, 97+%	138
MoSe ₂	Molybdenum(IV) selenide (99.9%-Mo).....	138
MoSi ₂	Molybdenum silicide (99+%-Mo)	138
	Molybdenum disilicide, 0.4-5.0 microns (99+%-Mo)	138
NNaO ₂	Sodium nitrite, 97+% (ACS)	419
NNaO ₃	Sodium nitrate, 99+% (ACS)	419
NO ₃ Rb	Rubidium nitrate (99%-Rb).....	362
NO ₃ Tl	Thallium(I) nitrate (99.99%-Tl) PURATREM..	432
	Thallium(I) nitrate (99.5%-Tl)	432
NTi	Titanium nitride (99+%-Ti)	442
NV	Vanadium nitride (99%-V).....	445
NZr	Zirconium nitride, 98%.....	458
N ₂ NiO ₆	Nickel(II) nitrate hexahydrate (99.9985%-Ni) PURATREM.....	175
	Nickel(II) nitrate hexahydrate (99.9+%-Ni)	175
N ₂ O ₆ Pb	Lead(II) nitrate, 99+% (ACS)	114
	Lead(II) nitrate (99.999%-Pb) PURATREM...	114
N ₂ O ₆ Pd	Palladium(II) nitrate hydrate (Pd ~40%) (99.9%-Pd)	248
N ₂ O ₆ Sr	Strontium nitrate, 99+% (ACS).....	423
	Strontium nitrate, 98+%	423
N ₂ O ₆ Zn	Zinc nitrate hexahydrate, min. 98%	453
N ₂ O ₇ Zr	Zirconium(IV) dinitrate oxide hydrate.....	457
N ₂ Sr ₃	Strontium nitride (99.5%-Sr)	423
N ₂ Na	Sodium azide, 98%.....	416
N ₃ NdO ₉	Neodymium(III) nitrate hexahydrate (99.9%-Nd) (REO)	170
	Neodymium(III) nitrate hexahydrate (99.999%-Nd) (REO) PURATREM	170
N ₃ O ₉ Pr	Praseodymium(III) nitrate hexahydrate (99.9%-Pr) (REO)	345
N ₃ O ₉ Rh	Rhodium(III) nitrate, solution in water (10% Rh).....	359
N ₃ O ₉ Sc	Scandium(III) nitrate pentahydrate (99.9%-Sc) (REO)	403
N ₃ O ₉ Sm	Samarium(III) nitrate hexahydrate (99.9%-Sm) (REO).....	402

Formula	Description	Page
N ₃ O ₉ Tb	Terbium(III) nitrate hexahydrate (99.9%-Tb) (REO)	431
N ₃ O ₉ Tm	Thulium(III) nitrate hexahydrate (99.9%-Tm) (REO)	433
N ₃ O ₉ Y	Yttrium(III) nitrate hexahydrate (99.999%-Y) (REO) PURATREM	449
	Yttrium(III) nitrate hexahydrate (99.9%-Y) (REO)	449
N ₃ O ₉ Yb	Ytterbium(III) nitrate pentahydrate (99.9%-Yb) (REO).....	447
N ₄ O ₁₀ Ru	Ruthenium(III) nitrosyl nitrate, solution (1.5% Ru).....	398
N ₄ O ₁₂ Th	Thorium(IV) nitrate hydrate (99.8%-Th).....	433
N ₄ Si ₃	Silicon(IV) nitride, < 5 micron (99%-Si)	410
NaNbO ₃	Sodium niobate (99.9%-Nb)	419
NaO ₃ V	Sodium metavanadate, min. 96%.....	419
NaO ₃ Re	Sodium perrhenate (99.9%-Re).....	420
NaPF ₆	Sodium hexafluorophosphate 99% (99.99%-Na) PURATREM	418
	Sodium hexafluorophosphate 99% (99.99%-Na) PURATREM	418
Na ₂ O	Sodium oxide/sodium on alumina, Olefin Isomerization Catalyst (Na ₂ O 11.5-13.5%, Na 1.8-3.0%)	420
Na ₂ O ₂	Sodium peroxide, min. 93% (ACS).....	420
Na ₂ O ₂ S	Sodium sulfite, anhydrous, 98+% (ACS).....	421
Na ₂ O ₂ Se	Sodium selenite, 99%.....	420
Na ₂ O ₂ Si	Sodium metasilicate, anhydrous, min. 95%...	419
	Sodium metasilicate pentahydrate, 99%	419
Na ₂ O ₂ Sn	Sodium stannate trihydrate, min. 95%.....	420
Na ₂ O ₄ S	Sodium sulfate, anhydrous, 99+% (ACS).....	420
	Sodium sulfate, anhydrous (99.999%-Na) PURATREM.....	420
Na ₂ O ₄ Te	Sodium tellurate(VI) dihydrate, 99.5%	421
Na ₂ O ₄ W	Sodium tungstate dihydrate, 99+% (ACS)....	421
Na ₂ O ₄ Ti ₃	Sodium titanate, 95%	421
Na ₂ S	Sodium sulfide, anhydrous, min. 95%	420
	Sodium sulfide nonahydrate, 98+% (ACS)....	421
Na ₃ O ₄ P	Sodium phosphate dodecahydrate, 98+% (ACS).....	420
Na ₄ O ₄ Si	Sodium orthosilicate	419
Na ₅ O ₁₀ P ₃	Sodium tripolyphosphate, tech. gr., min. 85%	421
NbO ₂	Niobium(IV) oxide, 99+%	177
Nb ₂ O ₅	Niobium(V) oxide (99.995%-Nb) (50-100ppm Ta) PURATREM.....	177
	Niobium(V) oxide (99.9%-Nb).....	177
	Niobium(V) oxide (99.5%-Nb).....	177
Nd ₂ O ₃	Neodymium(III) oxide (99.99+%-Nd) (REO) PURATREM.....	170
	Neodymium(III) oxide (99.9%-Nd) (REO).....	170
NiO	Nickel(II) oxide (99.998%-Ni) PURATREM....	176
	Nickel(II) oxide, green, 99%	176
	Nickel(II) oxide (99.9%-Ni) PURATREM.....	176
	Nickel(II) oxide, black (99.9+%).....	176
NiO ₄ S	Nickel(II) sulfate hexahydrate, 98+% (ACS)..	176
	Nickel(II) sulfate hexahydrate (99.99%-Ni) PURATREM.....	176
NiS	Nickel(II) sulfide (99.9%-Ni).....	176
OPb	Lead(II) oxide (Litharge), 99+%	114
	Lead(II) oxide (99.999+%-Pb) PURATREM ..	114
OPd	Palladium(II) oxide (99.9%-Pd).....	248
OSi	Silicon(II) oxide, granular +10 mesh (99.9%-Si)	410
	Silicon(II) oxide, -325 mesh (99.9%-Si).....	410
OSn	Tin(II) oxide, 98% (99+%-Sn)	437
OSr	Strontium oxide (99.9%-Sr)	423
OTi	Titanium(II) oxide, optical grade, pellets (99.9+%-Ti).....	442
OZn	Zinc oxide, catalyst (85-95% ZnO, 3-7% Al ₂ O ₃ , 0.5-3% CaO)	453
	Zinc oxide, 99.7%	453
	Zinc oxide (99.999%-Zn) PURATREM	453
	Zinc oxide, sintered tablets (99.9%-Zn).....	453
O ₂ Pb	Lead(IV) oxide, 97+% (ACS)	114
O ₂ Pt	Platinum(IV) oxide hydrate (-80-82% Pt) (99.95+%-Pt) ADAMS' CATALYST [BASF C7018].....	338

Formula Index

Formula	Description	Page
	Platinum(IV) oxide hydrate (~80-81% Pt)	
	ADAMS' CATALYST	338
O ₂ Re	Rhenium(IV) oxide dihydrate (99.9%-Re).....	347
O ₂ Ru	Ruthenium(IV) oxide, anhydrous (99.9+%-Ru).....	398
	Ruthenium(IV) oxide hydrate.....	398
O ₂ Se	Selenium(IV) oxide (99.999%-Se) PURA-TREM	404
	Selenium(IV) oxide, 99.8%	404
O ₂ Si	Silicon(IV) oxide, 99+%, 0.012 micron (fumed colloidal silica)	410
	Silicon(IV) oxide, -100 mesh, 99.7%	410
	Silicon(IV) oxide, 98%	410
	Silicon(IV) oxide, elec. gr. (99.999%-Si) PURATREM	410
O ₂ Sn	Tin(IV) oxide (99.998%-Sn) PURATREM	437
	Tin(IV) oxide (99.9%-Sn)	437
	Tin(IV) oxide, nanoparticle (30-60 nm), (99.7%-Sn)	166
O ₂ Te	Tellurium(IV) oxide, 99+%	430
	Tellurium(IV) oxide (99.999%-Te) PURATREM.....	430
O ₂ Ti	Titanium(IV) oxide, 99+%	442
	Titanium(IV) oxide (99.99+%-Ti) PURATREM.....	442
	Titanium(IV) oxide, sintered lumps, 99.5%	442
	Titanium(IV) oxide nanopowder Anatase.....	167
O ₂ V	Vanadium(IV) oxide, 99+%	445
O ₂ W	Tungsten(IV) oxide (99.9%-W)	444
O ₂ Zr	Zirconium(IV) oxide-ytria stabilized, 99%	458
	Zirconium(IV) oxide-ytria stabilized, 99%	458
	Zirconium(IV) oxide-ytria stabilized (99.95%-Zr)	458
	Zirconium(IV) oxide, 99+%	458
O ₃ PbTi	Lead(II) titanate, 99.5%	115
O ₃ PbZr	Lead(II) zirconate, 99%	115
O ₃ Re	Rhenium(VI) oxide (99.9%-Re)	347
O ₃ Rh ₂	Rhodium(III) oxide, anhydrous (99.9%-Rh) ...	359
	Rhodium(III) oxide pentahydrate, 99%	359
O ₃ Sb ₂	Antimony(III) oxide, 99+%	9
	Antimony(III) oxide, elec. gr. (99.999%-Sb) PURATREM.....	9
O ₃ Sc ₂	Scandium(III) oxide (99.9%-Sc) (REO)	403
	Scandium(III) oxide, sintered lumps (99.9%-Sc) (REO)	403
	Scandium(III) oxide (99.99%-Sc) (REO) PURATREM.....	403
O ₃ Sm ₂	Samarium(III) oxide (99.9%-Sm) (REO).....	402
	Samarium(III) oxide (99.99+%-Sm) (REO) PURATREM.....	402
O ₃ SrTi	Strontium titanate, 99+%	423
O ₃ SrZr	Strontium zirconate, 95%	423
O ₃ Tb ₂	Terbium(III,IV) oxide (99.9%-Tb) (REO)	431
O ₃ Tl ₂	Thallium(III) oxide (99.99%-Tl) PURATREM .	432
	Thallium(III) oxide (99.5%-Tl)	432
O ₃ Tm ₂	Thulium(III) oxide (99.9%-Tm) (REO).....	433
O ₃ V ₂	Vanadium(III) oxide, 95%	445
O ₃ W	Tungsten(VI) oxide (99.995%-W) PURATREM.....	444
	Tungsten(VI) oxide, sintered lumps (99.99%-W) PURATREM	444
	Tungsten(VI) oxide (min. 99.8%-W)	444
O ₃ Y ₂	Yttrium(III) oxide (99.99%-Y) (REO) PURATREM.....	449
	Yttrium(III) oxide (99.9%-Y) (REO)	449
	Yttrium(III) oxide (99.999%-Y) (REO) PURATREM.....	449
O ₃ Yb ₂	Ytterbium(III) oxide (99.9%-Yb) (REO).....	447
O ₄ Os	Osmium(VIII) oxide (99.95+%-Os)	213
	Osmium(VIII) oxide, 4% in water	213
	Osmium(VIII) oxide, Microencapsulated in a Styrene Polymer (~10%OsO ₄)	213
	Osmium(VIII) oxide (99.99+%-Os) PURATREM	213
	Osmium(VIII) oxide (99.99+%-Os), 4% in water PURATREM	213
O ₄ PPr	Praseodymium(III) phosphate	346

Formula	Description	Page
O ₄ PY	Yttrium(III) phosphate hydrate (99.99%-Y) (REO) PURATREM	449
O ₄ PbS	Lead(II) sulfide, 99%	115
O ₄ PdS	Palladium(II) sulfide dihydrate	248
O ₄ Rb ₂ S	Rubidium sulfide (99.8%-Rb)	362
O ₄ Ru	Ruthenium(VIII) oxide (0.5% stabilized aqueous solution)	398
O ₄ SSn	Tin(II) sulfide, 95+%	437
O ₄ STl ₂	Thallium(I) sulfide (99.999%-Tl) PURATREM.....	432
	Thallium(I) sulfide (99.5%-Tl)	432
O ₄ SZn	Zinc sulfide monohydrate, 99%	454
O ₄ Sb ₂	Antimony(IV) oxide (99.99%-Sb) PURA-TREM	9
O ₄ SiZr	Zirconium silicate, 98%	458
O ₄ P ₂	Phosphorus(V) oxide, 98+% (ACS).....	320
	Phosphorus(V) oxide (99.99%-P) PURATREM.....	320
O ₅ SV	Vanadium(IV) sulfate oxide hydrate.....	446
O ₅ SZr	Zirconium(IV) sulfate oxide hydrate.....	458
O ₅ Sb ₂	Antimony(V) oxide (99.9%-Sb)	9
	Antimony(V) oxide, elec. gr. (99.998%-Sb) PURATREM.....	9
O ₆ Ta ₂	Tantalum(V) oxide, 99.8% (99.95+%-Ta).....	429
	Tantalum(V) oxide, 99.8% (99.99+%-Ta) PURATREM.....	430
O ₆ V ₂	Vanadium(V) oxide, 98%	445
	Vanadium(V) oxide, 99.5%	445
	Vanadium(V) oxide (99.99%-V) PURATREM	445
O ₇ Re ₂	Rhenium(VII) oxide (99.99%-Re) PURATREM.....	347
O ₈ P ₂ Zn ₃	Zinc phosphate hydrate	453
O ₈ S ₂ Zr	Zirconium(IV) sulfate tetrahydrate (99.99+%-Zr) PURATREM.....	458
O ₁₁ Pr ₆	Praseodymium(III,IV) oxide (99.99%-Pr) (REO) PURATREM	346
O ₁₂ Pr ₂ S ₃	Praseodymium(III) sulfate hydrate (99.9%-Pr) (REO)	346
O ₁₂ S ₃ Sm ₂	Samarium(III) sulfate octahydrate (99.9%-Sm) (REO)	402
O ₁₂ S ₃ Y ₂	Yttrium(III) sulfate octahydrate (99.9%-Y) (REO)	450
O ₁₂ S ₃ Yb ₂	Ytterbium(III) sulfate octahydrate (99.9%-Yb) (REO).....	448
PbS	Lead(II) sulfide (99.999%-Pb) PURATREM... Lead sulfide CANdot® quantum dot (PbS core - -3nm), 10 mg/mL in toluene, 1000nm peak emission.....	115 161
	Lead sulfide CANdot® quantum dot (PbS core - -4.5nm), 10 mg/mL in toluene, 1200nm peak emission.....	161
	Lead sulfide CANdot® quantum dot (PbS core - -6nm), 10 mg/mL in toluene, 1400nm peak emission.....	161
	Lead sulfide CANdot® quantum dot (PbS core - -8nm), 10 mg/mL in toluene, 1600nm peak emission.....	161
PbSb	Lead antimonide, 99+%.....	114
PbSe	Lead(II) selenide (99.99%-Pb) PURATREM..	115
SSr	Strontium sulfide (99.9%-Sr)	423
SZn	Zinc sulfide (99.99%-Zn) (fused granules) PURATREM.....	454
	Zinc sulfide (99.9%-Zn)	454
S ₂ Se	Selenium(IV) sulfide, min. 94%	404
S ₂ Ti	Titanium(IV) sulfide (99.8%-Ti)	442
S ₂ W	Tungsten(IV) sulfide (99.5%-W)	444
S ₂ Zr	Zirconium(IV) sulfide, 99%	458
S ₃ Sb ₂	Antimony(III) sulfide (99.999%-Sb) PURATREM.....	9
	Antimony(V) sulfide, min. 98%	9
S ₃ Sb ₂	Antimony(III) telluride (99.96%-Sb)	9
Sb ₂ Te ₃	Zinc selenide (99.999%-Zn) PURATREM	453
SeZn	Zinc selenide (99.99%-Zn) PURATREM	453
SiBr ₄	Silicon(IV) bromide, (99.99% Si) PURATREM.....	409
SiC	Silicon carbide (>90% beta phase), 0.1-1.2 microns (99%-Si)	409

Formula Index

Formula	Description	Page
	Silicon carbide (>90% beta phase), 0.2-5.0 microns (99+% -Si)	409
	Silicon carbide (alpha phase), 0.2-1.2 microns (99% -Si)	409
Si ₂ Ta	Tantalum silicide (99.5%-Ta).....	430
Si ₂ Ti	Titanium silicide (99+% -Ti)	442
Si ₃ N ₄	Silicon nitride (>90% alpha phase), 0.2-4.0 microns (99% -Si)	410
	Silicon nitride, 0.2-2.5 microns (99.99%-Si) PURATREM.....	410
TeZn	Zinc telluride (99.99%-Zn) PURATREM	454
TiB ₂	Titanium boride, hexagonal crystalline solid, 0.7-10.0 microns, 99%.....	441
TiN	Titanium nitride, 1.3-1.9 microns (99+% -Ti)...	442
Y ₂ O ₃	Yttrium(III) oxide, 0.5-2.0 microns (99.95%- Y).	449
ZnO	Zinc oxide nanopowder	167

CAS Registry Index

Please note that this index only shows one purity for each chemical listed. Several purities or elemental forms may actually be available. Please turn to the relevant page for a complete listing.

CAS No.	Page
56-24-6	438
56-35-9	434
56-36-0	437
57-09-0	168
60-00-4	199
60-34-4	202
62-38-4	128
62-54-4	34
62-76-0	419
64-02-8	200
66-71-7	205
67-42-5	199
67-43-6	195
74-94-2	25
75-16-1	123
75-24-1	4
75-54-7	408
75-60-5	10
75-76-3	411
75-77-4	411
75-78-5	407
75-79-6	411
75-89-8	66
75-94-5	412
76-05-1	65
76-86-8	412
77-58-7	435
78-08-0	412
78-10-4	410
78-40-0	327
78-50-2	329
78-62-6	407
79-35-6	63
80-10-4	407
94-93-9	199
95-52-3	63
96-10-6	3
97-93-8	4
97-94-9	31
98-05-5	10
98-13-5	409
98-80-6	27
100-58-3	124
100-59-4	124
100-99-2	4
101-02-0	329
102-24-9	31
102-54-5	94
102-85-2	326
107-15-3	199
109-63-7	25
109-72-8	115
110-18-9	209
110-51-0	25
110-70-3	197
111-40-0	195
112-57-2	209
112-80-1	168
112-90-3	168
115-21-9	408
115-86-6	329
115-96-8	331
116-17-6	330
121-43-7	31
121-45-9	328
122-52-1	327
124-41-4	419
127-08-2	340

CAS No.	Page
127-09-3	416
132-16-1	109
136-51-6	35
136-52-7	49
136-53-8	452
136-85-6	202
141-52-6	418
142-71-2	56
143-19-1	169
143-33-9	417
143-36-2	128
143-66-8	421
144-55-8	419
147-14-8	58
149-11-1	56
149-74-6	408
150-46-9	31
151-21-3	168
151-50-8	341
244-87-1	251
283-56-7	30
294-90-6	207
295-14-7	208
295-37-4	208
298-07-7	296
301-08-6	114
301-10-0	436
306-94-5	65
307-35-7	65
311-89-7	65
320-51-4	63
326-06-7	63
326-91-0	65
333-20-0	344
335-36-4	65
335-67-1	64
335-95-5	65
344-04-7	63
344-07-0	63
353-83-3	66
354-51-8	63
354-64-3	64
355-42-0	65
355-80-6	64
356-42-3	65
358-23-6	66
363-72-4	64
366-18-7	179
367-12-4	63
367-57-7	65
371-41-5	63
373-61-5	25
374-00-5	66
374-99-2	63
375-85-9	65
376-06-7	168
376-18-1	64
376-73-8	64
379-52-2	438
383-63-1	63
392-56-3	64
407-25-0	65
409-21-2	409
420-37-1	221
422-64-0	64
429-41-4	7
429-42-5	7
431-35-6	63
445-29-4	63
455-19-6	66
462-06-6	63
471-34-1	35
496-74-2	425
497-19-8	417
501-65-5	39
506-61-6	344
506-64-9	414

CAS No.	Page
506-65-0	75
506-68-3	193
506-82-1	34
507-28-8	10
512-26-5	114
512-56-1	328
513-77-9	11
513-79-1	48
534-16-7	414
534-17-8	43
537-00-8	40
538-58-9	219
543-80-6	11
543-90-8	32
543-94-2	422
544-19-4	57
544-92-3	56
544-97-8	451
546-67-8	114
546-68-9	442
553-12-8	207
553-54-8	116
554-13-2	116
554-70-1	327
554-95-0	221
555-31-7	3
555-75-9	2
556-67-2	408
557-20-0	451
558-13-4	38
562-76-5	344
562-90-3	409
563-63-3	414
563-67-7	361
563-68-8	431
574-93-6	205
577-11-7	168
584-08-7	341
584-09-8	361
592-04-1	127
592-06-3	338
593-79-3	404
593-88-4	10
593-90-8	31
594-09-2	328
594-19-4	115
594-27-4	436
594-31-0	9
595-89-1	115
595-90-4	436
597-50-2	327
597-63-7	69
598-30-1	115
598-45-8	40
598-54-9	56
598-62-9	125
602-09-5	214
602-94-8	64
603-32-7	10
603-33-8	24
603-35-0	329
603-36-1	9
607-01-2	312
610-92-4	217
617-75-4	10
617-86-7	411
627-49-6	296
628-39-7	404
629-20-9	38
630-10-4	404
631-61-8	5
637-12-7	3
638-21-1	319
638-39-1	436
639-58-7	438
644-97-3	318
645-96-5	404

CAS No.	Page
647-42-7	65
653-37-2	64
661-36-9	8
661-69-8	435
670-54-2	209
672-66-2	299
676-58-4	123
676-83-5	315
678-26-2	65
678-39-7	65
681-84-5	410
683-18-1	435
684-16-2	64
684-19-5	288
685-83-6	261
686-69-1	296
688-73-3	437
688-74-4	30
693-04-9	121
700-16-3	65
739-58-2	302
753-73-1	435
753-89-9	39
756-79-6	299
762-04-9	296
769-40-4	65
771-60-8	64
771-61-9	64
771-62-0	65
775-12-2	407
787-70-2	215
789-25-3	412
791-28-6	329
791-31-1	412
811-62-1	298
813-19-4	435
814-91-5	57
814-94-8	437
814-95-9	423
815-82-7	58
815-85-0	437
816-43-3	116
818-08-6	435
819-19-2	288
822-16-2	420
822-68-4	283
824-72-6	318
827-15-6	64
829-84-5	292
829-85-6	303
855-38-9	332
865-34-9	117
865-35-0	429
865-47-4	340
865-48-5	417
865-52-1	69
866-81-9	48
868-59-7	167
873-51-8	27
900-95-8	438
917-23-7	209
917-23-7	209
917-54-4	119
917-58-8	341
919-30-2	405
920-39-8	124
920-66-1	64
925-90-6	121
933-18-6	30
940-71-6	320
947-42-2	407
960-71-4	31
983-80-2	268
984-43-0	268
993-07-7	412
993-16-8	435
993-42-0	69

CAS Registry Index

CAS No.	Page	CAS No.	Page	CAS No.	Page	CAS No.	Page
994-28-5	69	1287-13-4	364	1314-37-0	447	1679-18-1	26
994-30-9	411	1287-16-7	105	1314-56-3	320	1701-93-5	415
994-31-0	437	1291-31-2	101	1314-60-9	9	1730-25-2	120
998-40-3	325	1291-32-3	455	1314-61-0	429	1746-03-8	333
999-78-0	38	1291-47-0	102	1314-62-1	445	1765-40-8	64
999-97-3	408	1293-65-8	100	1314-68-7	347	1765-93-1	27
1002-88-6	50	1293-87-4	105	1314-87-0	115	1777-03-3	411
1006-01-5	328	1294-07-1	448	1314-96-1	423	1779-25-5	3
1008-89-5	205	1295-20-1	447	1314-98-3	454	1779-48-2	319
1009-93-4	408	1295-35-8	171	1315-04-4	9	1779-49-3	316
1017-60-3	311	1298-53-9	42	1315-09-9	453	1809-19-4	290
1017-88-5	299	1298-55-1	403	1315-11-3	454	1809-20-7	310
1031-93-2	325	1299-86-1	1	1316-98-9	100	1825-62-3	411
1034-39-5	285	1301-96-8	415	1317-33-5	138	1907-33-1	116
1038-95-5	332	1302-42-7	416	1317-34-6	126	1908-61-8	38
1064-10-4	435	1302-81-4	3	1317-35-7	126	1923-70-2	7
1066-26-8	416	1302-82-5	3	1317-36-8	114	2031-67-6	408
1066-30-4	45	1303-00-0	67	1317-37-9	109	2035-66-7	248
1066-37-1	70	1303-28-2	10	1317-38-0	57	2043-47-2	65
1066-44-0	438	1303-33-9	10	1317-39-1	57	2043-53-0	65
1066-45-1	438	1303-36-2	10	1317-40-4	58	2044-56-6	168
1066-54-2	412	1303-58-8	75	1317-42-6	50	2052-49-5	7
1066-77-9	435	1303-86-2	26	1317-60-8	108	2071-20-7	269
1067-33-0	434	1303-96-4	421	1317-61-9	108	2081-12-1	457
1067-42-1	69	1304-28-5	12	1317-80-2	167	2117-28-4	406
1068-55-9	124	1304-29-6	12	1318-02-1	135	2117-50-2	434
1068-69-5	412	1304-56-9	13	1327-50-0	9	2155-74-0	8
1070-89-9	419	1304-76-3	23	1327-53-3	10	2155-96-6	333
1071-76-7	457	1304-82-1	24	1330-43-4	421	2171-99-5	77
1078-58-6	451	1305-78-8	35	1332-58-7	3	2172-02-3	77
1079-66-9	302	1305-99-3	36	1332-81-6	9	2172-12-5	450
1080-43-9	435	1306-19-0	32	1333-82-0	46	2176-98-9	436
1088-00-2	318	1306-23-6	33	1333-86-4	36	2223-95-2	176
1100-88-5	252	1306-24-7	32	1336-93-2	126	2234-97-1	330
1109-15-5	31	1306-25-8	34	1338-02-9	57	2269-22-9	1
1111-67-7	58	1306-38-3	41	1338-14-3	108	2273-45-2	435
1115-99-7	68	1307-81-9	418	1341-49-7	6	2273-51-0	435
1118-46-3	434	1308-06-1	49	1344-28-1	2	2279-76-7	438
1118-71-4	221	1308-38-9	46	1344-43-0	126	2304-30-5	321
1124-19-2	435	1308-87-8	60	1345-04-6	9	2314-97-8	66
1132-39-4	404	1308-96-9	62	1345-07-9	24	2378-02-1	65
1134-35-6	197	1309-37-1	108	1445-79-0	68	2386-64-3	121
1135-99-5	435	1309-42-8	122	1449-55-4	435	2414-98-4	122
1141-38-4	219	1309-48-4	122	1450-14-2	408	2457-01-4	11
1148-79-4	207	1309-60-0	114	1461-22-9	437	2457-02-5	423
1159-54-2	326	1309-64-4	9	1461-25-2	435	2501-94-2	282
1184-54-9	57	1310-53-8	69	1486-28-8	315	2519-10-0	39
1184-57-2	128	1310-58-3	343	1493-13-6	66	2528-38-3	325
1185-55-3	408	1310-61-8	342	1493-27-2	63	2530-87-2	406
1191-15-7	3	1310-65-2	117	1496-94-2	330	2556-53-8	35
1259-35-4	332	1310-66-3	117	1498-40-4	312	2622-14-2	326
1263-63-4	202	1310-73-2	419	1499-21-4	303	2627-95-4	407
1270-98-0	439	1310-82-3	362	1515-14-6	64	2683-82-1	204
1271-03-0	226	1311-10-0	423	1518-16-7	209	2751-90-8	325
1271-07-4	339	1311-93-9	7	1522-22-1	64	2767-54-6	437
1271-19-8	439	1312-41-0	79	1529-47-1	70	2767-80-8	332
1271-24-5	44	1312-43-2	80	1529-48-2	69	2769-64-4	38
1271-28-9	171	1312-73-8	344	1530-32-1	312	2794-60-7	12
1271-42-7	105	1312-81-8	112	1538-59-6	9	2795-39-3	65
1271-51-8	111	1313-13-9	126	1548-13-6	66	2809-21-4	314
1271-54-1	44	1313-22-0	127	1560-54-9	250	2844-89-5	283
1271-55-2	94	1313-27-5	138	1571-33-1	319	2923-17-3	118
1271-86-9	102	1313-60-6	420	1585-90-6	201	2923-18-4	421
1271-94-9	100	1313-82-2	420	1586-73-8	408	2923-28-6	415
1272-21-5	67	1313-84-4	421	1592-23-0	36	2946-61-4	318
1272-23-7	113	1313-96-8	177	1600-27-7	127	2949-42-0	436
1272-26-0	433	1313-97-9	170	1605-65-8	263	2960-37-4	266
1273-73-0	99	1313-99-1	176	1608-26-0	331	2966-50-9	415
1273-81-0	213	1314-08-5	248	1626-24-0	70	2980-59-8	109
1273-86-5	106	1314-11-0	423	1630-79-1	29	2996-92-1	409
1273-89-8	105	1314-13-2	453	1633-05-2	422	3007-31-6	167
1273-97-8	98	1314-23-4	458	1643-19-2	7	3017-60-5	50
1273-98-9	170	1314-28-9	347	1648-99-3	65	3027-21-2	408
1277-43-6	47	1314-32-5	432	1661-03-6	123	3087-36-3	442
1277-47-0	445	1314-34-7	445	1662-01-7	198	3087-39-6	441
1277-49-2	106	1314-35-8	444	1663-45-2	268	3094-87-9	106
1284-72-6	120	1314-36-9	449	1666-13-3	404	3109-63-5	7

CAS Registry Index

CAS No.	Page	CAS No.	Page	CAS No.	Page	CAS No.	Page
3115-68-2	321	5925-55-3	426	7440-20-2	403	7650-88-6	327
3124-01-4	114	5926-79-4	436	7440-21-3	404	7650-89-7	325
3125-07-3	169	5936-11-8	345	7440-22-4	412	7650-91-1	251
3153-26-2	445	5970-44-5	449	7440-23-5	416	7664-38-2	320
3164-85-0	341	5970-45-6	452	7440-24-6	422	7681-11-0	343
3236-82-6	177	6002-40-0	287	7440-25-7	428	7681-49-4	418
3264-82-2	174	6018-89-9	174	7440-27-9	431	7681-65-4	57
3275-24-9	441	6018-94-6	176	7440-28-0	431	7681-82-5	419
3277-26-7	411	6046-93-1	56	7440-30-4	433	7688-25-7	267
3317-67-7	50	6047-25-2	108	7440-31-5	434	7693-26-7	342
3347-62-4	203	6063-89-4	3	7440-32-6	438	7699-45-8	452
3375-31-3	247	6074-84-6	429	7440-33-7	443	7704-34-9	423
3375-32-4	248	6080-56-4	114	7440-36-0	8	7704-98-5	442
3385-78-2	80	6099-21-4	424	7440-38-2	9	7705-08-0	107
3385-94-2	406	6108-17-4	115	7440-39-3	10	7718-54-9	175
3396-11-0	42	6108-23-2	117	7440-41-7	13	7718-98-1	445
3411-48-1	329	6131-99-3	417	7440-42-8	24	7719-12-2	320
3444-17-5	45	6147-53-1	48	7440-43-9	32	7720-83-4	442
3504-40-3	402	6156-78-1	125	7440-44-0	36	7721-01-9	429
3559-74-8	412	6163-58-2	333	7440-45-1	40	7722-76-1	5
3585-33-9	116	6165-68-0	30	7440-46-2	42	7726-95-6	31
3676-97-9	324	6192-12-7	345	7440-47-3	44	7727-15-3	1
3804-23-7	403	6192-13-8	169	7440-48-4	46	7727-18-6	446
3811-04-9	341	6224-63-1	332	7440-50-8	53	7757-79-1	343
3827-49-4	63	6372-42-5	283	7440-52-0	61	7757-82-6	420
3906-55-6	175	6381-59-5	344	7440-53-1	62	7757-83-7	421
3982-91-0	325	6381-92-6	199	7440-54-2	66	7757-93-9	36
4006-38-6	288	6411-21-8	261	7440-55-3	67	7758-02-3	340
4023-53-4	331	6476-36-4	329	7440-56-4	69	7758-11-4	342
4045-44-7	39	6476-37-5	292	7440-57-5	70	7758-29-4	421
4097-89-6	210	6484-52-2	6	7440-58-6	76	7758-87-4	36
4098-98-0	410	6487-39-4	112	7440-60-0	78	7758-88-5	41
4125-25-1	325	6596-96-9	10	7440-62-2	444	7758-89-6	56
4130-08-9	412	6737-42-4	270	7440-64-4	446	7758-94-3	107
4168-73-4	327	6742-68-3	60	7440-65-5	448	7758-95-4	114
4254-15-3	220	6742-69-4	448	7440-66-6	450	7758-98-7	58
4325-85-3	31	6813-38-3	195	7440-67-7	454	7758-99-8	58
4419-47-0	440	6834-92-0	419	7440-69-9	22	7761-88-8	414
4454-16-4	175	6843-66-9	407	7440-70-2	34	7772-99-8	436
4485-12-5	118	6865-35-6	12	7440-74-6	79	7773-01-5	126
4488-22-6	193	6874-60-8	284	7446-07-3	430	7774-29-0	127
4519-28-2	325	6921-34-2	120	7446-08-4	404	7775-09-9	417
4605-14-5	208	6923-52-0	8	7446-14-2	115	7775-41-9	414
4645-32-3	333	7188-38-7	38	7446-18-6	432	7778-44-1	34
4671-75-4	321	7211-39-4	299	7446-19-7	454	7778-50-9	341
4706-17-6	332	7289-92-1	9	7446-31-3	458	7778-53-2	344
4721-17-9	313	7307-04-2	218	7446-33-5	450	7778-74-7	343
4721-24-8	313	7321-53-1	107	7446-70-0	1	7778-77-0	341
4724-47-4	316	7325-46-4	220	7447-39-4	56	7778-80-5	344
4724-48-5	318	7337-45-3	25	7447-40-7	341	7782-49-2	404
4730-54-5	210	7360-44-3	1	7447-41-8	116	7782-61-8	108
4731-53-7	329	7393-43-3	435	7487-88-9	123	7782-63-0	109
4731-65-1	332	7429-90-5	1	7487-94-7	127	7782-64-1	126
4741-99-5	208	7429-91-6	60	7488-54-2	362	7782-86-7	127
4766-57-8	410	7439-88-5	84	7488-55-3	437	7782-89-0	116
4808-30-4	434	7439-89-6	94	7488-56-4	404	7783-00-8	404
4848-43-5	304	7439-91-0	111	7521-80-4	406	7783-03-1	444
4851-53-0	261	7439-92-1	113	7532-85-6	435	7783-08-6	404
4984-82-1	417	7439-93-2	115	7543-51-3	453	7783-20-2	6
5074-71-5	278	7439-94-3	119	7550-35-8	116	7783-28-0	6
5112-95-8	266	7439-95-4	120	7550-45-0	441	7783-34-8	127
5137-70-2	312	7439-96-5	124	7558-79-4	419	7783-35-9	128
5263-02-5	452	7439-97-6	127	7580-67-8	117	7783-39-3	127
5419-55-6	31	7439-98-7	136	7601-89-0	420	7783-40-6	122
5518-52-5	327	7440-00-8	169	7631-86-9	410	7783-46-2	114
5518-62-7	279	7440-02-0	170	7631-95-0	419	7783-47-3	436
5522-66-7	207	7440-03-1	176	7631-99-4	419	7783-48-4	423
5588-84-1	446	7440-04-2	213	7632-00-0	419	7783-49-5	452
5593-70-4	441	7440-05-3	224	7646-69-7	419	7783-50-8	107
5707-04-0	404	7440-06-4	335	7646-78-8	436	7783-51-9	68
5720-05-8	30	7440-09-7	340	7646-79-9	48	7783-52-0	80
5720-06-9	27	7440-10-0	345	7646-85-7	452	7783-53-1	126
5720-07-0	27	7440-15-5	346	7647-10-1	248	7783-56-4	9
5743-04-4	32	7440-16-6	348	7647-14-5	417	7783-62-2	436
5809-49-4	403	7440-17-7	361	7647-15-6	416	7783-63-3	442
5895-47-6	402	7440-18-8	362	7647-17-8	43	7783-64-4	458
5895-48-7	62	7440-19-9	401	7647-18-9	8	7783-68-8	177

CAS Registry Index

CAS No.	Page	CAS No.	Page	CAS No.	Page	CAS No.	Page
7783-71-3	429	7791-07-3	420	10049-10-2	45	10589-94-3	193
7783-85-9	6	7791-11-9	361	10049-21-5	417	11065-24-0	92
7783-90-6	414	7791-13-1	48	10060-10-3	41	11070-19-2	399
7783-93-9	415	7791-20-0	175	10060-12-5	45	11072-92-7	340
7783-95-1	414	7791-23-3	404	10060-13-6	5	11077-59-1	346
7783-96-2	414	7803-55-6	6	10097-28-6	410	11089-20-6	138
7783-99-5	414	8017-16-1	320	10099-58-8	112	11135-81-2	340
7784-01-2	414	9001-62-1	20	10099-66-8	119	11136-36-0	439
7784-09-0	415	9002-92-0	168	10099-67-9	119	12001-85-3	453
7784-13-6	2	9003-39-8	168	10099-74-8	114	12002-99-2	415
7784-18-1	2	9003-53-6	40	10101-41-4	36	12003-13-3	441
7784-19-2	5	9005-64-5	168	10101-52-7	458	12003-65-5	112
7784-23-8	2	9014-01-1	13	10101-58-3	50	12005-82-2	414
7784-27-2	2	9017-40-7	206	10101-63-0	114	12005-86-6	418
7784-31-8	3	9080-56-2	21	10101-89-0	420	12006-15-4	32
7784-33-0	9	10022-31-8	12	10101-97-0	176	12006-40-5	452
7784-34-1	10	10022-66-9	343	10102-05-3	248	12007-00-0	174
7784-45-4	10	10022-68-1	32	10102-18-8	420	12007-09-9	444
7785-23-1	414	10024-93-8	169	10102-24-6	117	12007-60-2	118
7786-30-3	122	10025-64-6	453	10102-40-6	419	12008-21-8	112
7787-32-8	11	10025-65-7	338	10102-45-1	432	12008-75-2	43
7787-35-1	11	10025-68-0	404	10102-68-8	35	12012-35-0	45
7787-58-8	23	10025-69-1	436	10108-64-2	32	12012-50-9	344
7787-60-2	23	10025-70-4	423	10112-91-1	127	12012-95-2	226
7787-61-3	23	10025-73-7	45	10119-53-6	42	12013-56-8	36
7787-64-6	23	10025-74-8	60	10125-13-0	56	12013-82-0	35
7787-69-1	43	10025-75-9	61	10138-41-7	61	12014-56-1	41
7787-70-4	56	10025-76-0	62	10138-52-0	66	12018-10-9	56
7788-97-8	45	10025-77-1	107	10138-62-2	78	12020-58-5	62
7789-02-8	46	10025-82-8	80	10139-47-6	453	12022-99-0	109
7789-17-5	43	10025-83-9	92	10139-58-9	359	12024-21-4	68
7789-18-6	44	10025-84-0	112	10150-27-3	304	12025-32-0	69
7789-19-7	56	10025-87-3	320	10163-15-2	418	12026-05-0	362
7789-23-3	341	10025-90-8	345	10170-03-3	212	12027-06-4	6
7789-24-4	117	10025-91-9	8	10170-68-0	45	12027-67-7	6
7789-27-7	432	10025-94-2	449	10170-69-1	126	12028-48-7	6
7789-28-8	107	10025-97-5	92	10196-18-6	453	12029-98-0	81
7789-29-9	342	10025-98-6	344	10199-00-5	179	12030-24-9	80
7789-39-1	361	10025-99-7	344	10210-68-1	48	12030-49-8	92
7789-40-4	432	10026-03-6	404	10213-10-2	421	12030-85-2	343
7789-41-5	35	10026-04-7	409	10241-05-1	138	12030-88-5	344
7789-42-6	32	10026-06-9	436	10277-43-7	112	12031-49-1	113
7789-45-9	56	10026-07-0	430	10277-44-8	346	12031-63-9	118
7789-46-0	107	10026-11-6	457	10294-26-5	415	12031-66-2	118
7789-47-1	127	10026-12-7	177	10294-28-7	75	12032-20-1	119
7789-48-2	122	10026-13-8	320	10294-29-8	75	12032-30-3	123
7789-59-5	320	10026-17-2	49	10294-31-2	75	12033-82-8	423
7789-60-8	320	10026-18-3	49	10294-33-4	25	12033-89-5	410
7789-61-9	8	10026-22-9	49	10294-39-0	12	12034-09-2	419
7789-65-3	404	10026-24-1	50	10294-41-4	41	12034-36-5	421
7789-66-4	409	10028-18-9	175	10294-46-9	57	12034-59-2	177
7789-67-5	436	10031-20-6	125	10294-50-5	50	12036-09-8	347
7789-68-6	441	10031-22-8	114	10294-54-9	44	12036-10-1	398
7789-75-5	35	10031-24-0	436	10294-70-9	437	12036-21-4	445
7789-78-8	35	10031-25-1	45	10326-27-9	11	12036-22-5	444
7789-80-2	35	10031-26-2	107	10326-28-0	32	12036-35-0	359
7789-82-4	35	10031-27-3	430	10361-37-2	11	12036-39-4	423
7790-22-9	117	10031-30-8	36	10361-79-2	345	12036-44-1	433
7790-29-6	362	10031-43-3	57	10361-82-7	402	12037-01-3	431
7790-30-9	432	10031-51-3	61	10361-84-9	403	12037-29-5	346
7790-33-2	126	10031-53-5	62	10361-91-8	447	12037-58-0	444
7790-34-3	175	10031-55-7	63	10361-92-9	449	12039-13-3	442
7790-38-7	248	10034-81-8	123	10377-51-2	117	12039-15-5	458
7790-39-8	338	10034-82-9	417	10377-52-3	118	12039-79-1	430
7790-44-5	9	10034-98-7	448	10377-66-9	126	12039-83-7	442
7790-47-8	437	10034-99-8	123	10378-50-4	343	12045-63-5	441
7790-48-9	430	10035-01-5	447	10424-65-4	169	12045-78-2	344
7790-53-6	343	10035-06-0	23	10431-47-7	344	12047-27-7	12
7790-60-5	345	10035-10-6	31	10433-06-4	8	12047-79-9	12
7790-69-4	118	10038-98-9	69	10450-59-6	42	12048-51-0	24
7790-75-2	36	10042-76-9	423	10466-65-6	343	12049-50-2	36
7790-76-3	36	10042-88-3	431	10476-81-0	422	12054-48-7	175
7790-79-6	32	10043-11-5	26	10476-85-4	422	12055-23-1	77
7790-80-9	32	10043-35-3	25	10534-88-0	174	12055-62-8	79
7790-86-5	40	10049-05-5	45	10534-89-1	51	12057-24-8	118
7790-87-6	41	10049-07-7	359	10553-31-8	11	12058-18-3	138
7791-03-9	118	10049-08-8	398	10563-26-5	208	12060-00-3	115

CAS Registry Index

CAS No.	Page	CAS No.	Page	CAS No.	Page	CAS No.	Page
12060-01-4	115	12209-98-2	420	13463-39-3	175	13746-66-2	342
12060-08-4	403	12212-68-9	44	13463-40-6	108	13755-29-8	421
12060-58-1	402	12228-87-4	6	13463-67-7	442	13755-32-3	12
12060-59-2	423	12229-13-9	343	13464-82-9	80	13759-83-6	402
12061-16-4	61	12230-71-6	11	13464-83-0	92	13759-92-7	62
12063-98-8	68	12245-39-5	349	13465-09-3	80	13760-80-0	447
12064-62-9	67	12246-51-4	87	13465-10-6	80	13762-14-6	49
12065-11-1	69	12254-85-2	45	13465-14-0	80	13762-51-1	340
12068-85-8	107	12257-42-0	357	13465-15-1	80	13765-19-0	35
12069-00-5	115	12260-45-6	43	13465-19-5	112	13765-24-7	402
12069-32-8	25	12261-30-2	58	13465-55-9	402	13765-25-8	62
12069-69-1	56	12266-38-5	114	13465-58-2	402	13765-26-9	67
12069-89-5	137	12266-72-7	337	13465-60-6	403	13767-03-8	122
12070-06-3	429	12266-92-1	338	13465-84-4	410	13767-32-3	453
12070-08-5	441	12279-09-3	356	13465-93-5	415	13768-11-1	347
12070-12-1	444	12289-94-0	366	13470-08-1	442	13775-53-6	418
12070-14-3	457	12317-46-3	239	13470-13-8	444	13777-22-5	77
12073-36-8	337	12354-84-6	90	13470-26-3	445	13777-25-8	457
12078-25-0	51	12354-85-7	357	13472-30-5	419	13779-41-4	297
12079-65-1	125	12427-42-8	50	13472-33-8	420	13780-42-2	68
12079-73-1	347	12501-23-4	444	13473-77-3	119	13782-33-7	239
12080-32-9	337	12539-26-3	43	13476-99-8	445	13798-24-8	431
12081-16-2	356	12582-61-5	109	13477-09-3	11	13801-49-5	456
12081-18-4	228	12636-72-5	454	13477-34-4	35	13813-22-4	112
12081-22-0	247	12671-00-0	457	13477-36-6	36	13813-24-6	170
12081-88-8	341	13005-35-1	57	13477-89-9	169	13813-42-8	61
12082-08-5	44	13007-90-4	173	13478-00-7	175	13814-75-0	138
12082-47-2	348	13007-92-6	45	13478-06-3	45	13815-39-9	344
12083-48-6	445	13029-09-9	39	13478-10-9	107	13820-40-1	6
12083-92-0	337	13126-12-0	362	13478-18-7	137	13820-41-2	7
12084-29-6	11	13146-23-1	58	13478-33-6	49	13820-44-5	248
12086-40-7	106	13177-41-8	168	13478-45-0	177	13820-46-7	339
12091-64-4	137	13185-00-7	216	13478-93-8	175	13820-53-6	421
12092-47-6	356	13266-82-5	449	13494-80-9	430	13820-91-2	344
12093-05-9	100	13266-83-6	41	13494-98-9	449	13820-95-6	357
12093-10-6	105	13276-04-5	31	13498-06-1	170	13826-83-0	7
12107-56-1	239	13282-39-8	453	13498-08-3	448	13826-86-3	204
12108-04-2	445	13283-01-7	444	13498-12-9	67	13826-88-5	454
12108-13-3	127	13292-87-0	25	13499-05-3	77	13826-93-2	344
12112-67-3	87	13314-52-8	69	13510-35-5	80	13826-94-3	344
12116-66-4	76	13395-16-9	56	13510-42-4	362	13845-36-8	345
12125-01-8	5	13400-13-0	43	13520-61-1	176	13859-68-2	174
12125-02-9	5	13406-29-6	332	13520-78-0	444	13862-78-7	7
12125-77-8	136	13428-80-3	77	13536-79-3	112	13874-04-9	6
12126-34-0	99	13434-24-7	126	13536-80-6	169	13896-65-6	398
12126-50-0	99	13444-94-5	248	13537-18-3	433	13922-41-3	27
12129-06-5	440	13446-03-2	125	13537-22-9	63	13933-32-9	339
12129-51-0	439	13446-18-9	122	13537-32-1	313	13938-94-8	356
12129-69-0	443	13446-19-0	123	13566-03-5	248	13939-06-5	137
12130-65-3	439	13446-34-9	126	13568-40-6	117	13940-83-5	175
12130-88-0	347	13446-53-2	122	13568-45-1	119	13963-57-0	1
12131-44-1	238	13446-74-7	362	13569-60-3	402	13963-58-1	342
12132-04-6	138	13450-87-8	67	13569-80-7	60	13965-03-2	238
12132-87-5	381	13450-88-9	67	13573-08-5	69	13967-25-4	127
12135-76-1	6	13450-90-3	68	13573-11-0	123	13967-50-5	341
12136-58-2	118	13450-91-4	68	13587-16-1	116	13986-18-0	452
12136-78-6	138	13450-92-5	69	13596-35-5	347	13986-26-0	458
12137-20-1	442	13450-95-8	69	13598-33-9	423	13991-08-7	266
12138-09-9	444	13450-97-0	423	13598-65-7	6	14013-15-1	126
12145-47-0	236	13451-11-1	429	13600-98-1	419	14014-09-6	431
12145-48-1	337	13451-14-4	430	13601-08-6	248	14014-88-1	398
12145-60-7	174	13451-19-9	431	13675-18-8	29	14017-39-1	109
12148-49-1	455	13453-07-1	75	13682-61-6	344	14017-47-1	42
12148-71-9	91	13453-62-8	114	13682-73-0	341	14017-52-8	67
12148-72-0	358	13453-69-5	117	13703-88-3	30	14017-56-2	449
12150-46-8	97	13453-70-8	116	13709-31-4	446	14023-80-4	90
12152-72-6	100	13453-78-6	118	13709-36-9	446	14024-18-1	106
12154-84-6	88	13453-80-0	116	13709-38-1	112	14024-56-7	122
12154-95-9	100	13454-74-5	42	13709-42-7	169	14024-58-9	125
12170-97-7	392	13454-84-7	44	13709-46-1	345	14024-61-4	247
12179-02-1	419	13454-96-1	338	13709-47-2	403	14024-64-7	442
12182-82-0	46	13455-12-4	338	13709-49-4	449	14040-05-2	55
12184-22-4	136	13455-21-5	341	13709-59-6	433	14040-11-0	444
12184-26-8	443	13462-88-9	175	13716-10-4	286	14047-29-1	26
12184-52-0	94	13462-90-3	175	13716-12-6	326	14055-02-8	176
12190-79-3	116	13463-10-0	109	13718-26-8	419	14074-80-7	453
12193-47-4	422	13463-12-2	107	13718-50-8	11	14075-53-7	344

CAS Registry Index

CAS No.	Page	CAS No.	Page	CAS No.	Page	CAS No.	Page
14096-82-3	50	14609-54-2	209	15442-64-5	453	16920-93-7	341
14098-44-3	214	14630-40-1	406	15444-43-6	432	16920-94-8	342
14099-01-5	347	14635-75-7	204	15453-87-9	80	16921-30-5	342
14101-95-2	438	14637-88-8	60	15461-27-5	457	16921-91-8	204
14104-20-2	415	14640-21-2	123	15467-20-6	204	16924-51-9	418
14126-37-5	173	14643-66-4	192	15469-38-2	108	16925-25-0	418
14126-40-0	51	14646-29-8	119	15489-27-7	118	16940-66-2	416
14126-87-5	136	14647-23-5	172	15492-38-3	359	16940-81-1	313
14128-54-2	115	14689-45-3	32	15492-45-2	120	16940-92-4	5
14165-55-0	69	14692-17-2	60	15492-47-4	170	16940-97-9	342
14172-90-8	50	14694-95-2	357	15492-48-5	346	16941-06-3	204
14172-92-0	175	14705-63-6	446	15492-49-6	403	16941-11-0	6
14174-09-5	216	14717-56-7	458	15492-50-9	403	16949-15-8	116
14175-02-1	62	14768-15-1	67	15492-51-0	431	16950-06-4	9
14175-03-2	402	14781-45-4	57	15492-52-1	447	16962-40-6	6
14187-32-7	216	14791-99-2	436	15522-69-7	60	16962-47-3	6
14220-21-4	347	14814-07-4	61	15522-71-1	63	16971-33-8	369
14220-64-5	236	14852-83-6	236	15522-73-3	79	17029-16-2	117
14221-01-3	248	14871-41-1	87	15523-24-7	421	17083-68-0	75
14221-02-4	339	14873-63-3	337	15529-49-4	393	17083-85-1	7
14221-06-8	137	14874-82-9	357	15529-90-5	74	17084-13-8	342
14242-05-8	415	14876-47-2	111	15573-31-6	320	17116-13-1	419
14243-64-2	74	14877-41-9	53	15573-38-3	332	17185-29-4	358
14264-16-5	173	14898-67-0	398	15590-62-2	117	17194-00-2	11
14267-08-4	239	14911-01-4	76	15602-15-0	122	17218-47-2	342
14282-91-8	397	14913-14-5	113	15604-36-1	337	17250-25-8	91
14283-05-7	59	14913-33-8	337	15608-29-4	359	17252-51-6	199
14283-07-9	118	14914-84-2	78	15629-92-2	172	17261-28-8	303
14284-06-1	56	14925-09-8	202	15631-58-0	433	17272-45-6	112
14284-87-8	66	14933-08-5	167	15632-39-0	449	17299-07-9	219
14284-89-0	125	14937-45-2	313	15635-87-7	92	17439-11-1	440
14284-92-5	358	14949-69-0	175	15651-37-3	339	17455-13-9	216
14284-93-6	398	14951-50-9	74	15653-01-7	40	17475-67-1	77
14284-95-8	431	14972-70-4	418	15663-27-1	337	17476-04-9	118
14284-98-1	447	14973-89-8	355	15681-89-7	416	17499-68-2	458
14285-68-8	347	14977-61-8	46	15684-36-3	176	17501-44-9	457
14286-02-3	337	14984-76-0	340	15692-07-6	337	17524-05-9	138
14298-31-8	346	14985-18-3	457	15696-40-9	213	17567-17-8	343
14307-35-8	117	14995-22-3	109	15746-57-3	383	17587-22-3	64
14319-08-5	5	14996-60-2	213	15752-05-3	5	17594-47-7	13
14319-13-2	113	14996-61-3	92	15878-77-0	345	17648-16-7	258
14320-04-8	453	15002-31-0	342	15909-92-9	256	17685-52-8	107
14323-32-1	344	15059-52-6	60	15956-28-2	358	17696-69-4	200
14324-82-4	58	15060-55-6	7	16009-13-5	106	17702-41-9	26
14324-83-5	176	15104-46-8	263	16009-86-2	436	17712-66-2	342
14324-99-3	127	15112-89-7	412	16165-32-5	46	17763-95-0	215
14325-24-7	127	15163-36-7	167	16343-08-1	27	17786-31-1	52
14363-14-5	450	15170-57-7	338	16419-60-6	30	17856-92-7	204
14364-93-3	338	15201-61-3	109	16454-60-7	170	17906-35-3	412
14404-33-2	343	15214-66-1	228	16456-81-8	109	17927-72-9	441
14405-43-7	67	15227-42-6	337	16469-18-4	67	17933-03-8	30
14405-45-9	79	15230-79-2	119	16523-54-9	291	17978-75-5	62
14434-22-1	418	15238-00-3	49	16523-89-0	325	17978-76-6	170
14434-47-0	46	15243-33-1	398	16605-03-1	308	17978-77-7	346
14456-34-9	77	15244-10-7	109	16674-78-5	121	18039-90-2	443
14457-87-5	40	15244-35-6	33	16712-20-2	116	18115-70-3	115
14459-95-1	342	15244-38-9	46	16721-80-5	419	18162-48-6	406
14476-16-5	107	15278-97-4	74	16733-97-4	116	18166-43-3	411
14481-08-4	172	15280-53-2	66	16743-33-2	452	18253-54-8	437
14481-29-9	5	15280-55-4	60	16774-21-3	5	18267-08-8	457
14483-18-2	79	15280-57-6	61	16800-45-6	443	18282-10-5	437
14507-19-8	112	15280-58-7	447	16812-54-7	176	18284-36-1	358
14516-54-2	126	15282-88-9	114	16829-47-3	7	18323-96-1	447
14523-22-9	356	15283-51-9	109	16834-13-2	209	18346-57-1	48
14526-22-8	109	15293-74-0	117	16853-85-3	115	18424-17-4	117
14532-05-9	67	15304-57-1	437	16871-60-6	342	18437-78-0	331
14540-52-4	329	15305-72-3	397	16871-90-2	342	18497-13-7	337
14551-74-7	170	15306-18-0	2	16872-09-6	26	18498-01-6	47
14553-08-3	61	15321-51-4	108	16872-11-0	28	18531-94-7	214
14553-09-4	345	15336-18-2	5	16883-45-7	7	18531-95-8	193
14564-35-3	391	15364-94-0	127	16893-05-3	339	18531-99-2	214
14588-08-0	235	15366-08-2	121	16893-06-4	339	18532-87-1	379
14589-42-5	402	15432-56-1	56	16893-85-9	418	18583-60-3	342
14589-44-7	433	15435-60-6	213	16919-19-0	6	18653-98-0	185
14591-44-7	111	15435-71-9	416	16919-58-7	5	18741-85-0	193
14592-56-4	236	15439-16-4	207	16919-73-6	342	18746-63-9	5
14592-80-4	45	15442-57-6	337	16920-56-2	342	18779-08-3	119

CAS Registry Index

CAS No.	Page	CAS No.	Page	CAS No.	Page	CAS No.	Page
18820-29-6	127	21679-31-2	45	26377-04-8	434	34269-03-9	81
18845-54-0	410	21679-46-9	48	26437-48-9	332	34330-64-8	32
18865-74-2	457	21797-13-7	248	26504-29-0	425	34338-96-0	219
18868-43-4	138	21908-53-2	128	26567-10-2	220	34364-26-6	23
18899-64-4	279	21959-01-3	456	26608-34-4	200	34409-44-4	236
18902-42-6	398	22031-12-5	331	26628-22-8	416	34431-47-5	433
18911-76-7	449	22180-53-6	236	26677-68-9	433	34513-98-9	398
18917-91-4	2	22205-45-4	58	26896-20-8	38	34622-08-7	170
18923-92-7	61	22206-57-1	7	27057-09-6	173	34767-44-7	455
18960-54-8	42	22306-37-2	23	27057-71-2	213	34767-55-0	348
18972-56-0	122	22398-80-7	80	27253-33-4	35	34801-95-1	89
18987-59-2	237	22440-93-3	182	27546-07-2	5	34801-97-3	383
19106-89-9	113	22441-13-0	119	27607-77-8	412	34822-89-4	79
19132-06-0	215	22441-14-1	345	27721-02-4	270	34822-90-7	431
19164-92-2	203	22464-99-9	458	27804-64-4	406	34825-99-5	283
19168-23-1	5	22466-49-5	418	27854-88-2	203	34872-98-5	138
19189-19-6	67	22519-64-8	80	27860-55-5	446	34946-82-2	58
19200-21-6	204	22560-21-0	345	27988-77-8	75	34984-16-2	180
19232-03-2	172	22594-69-0	393	28110-70-5	46	35132-20-8	198
19236-14-7	346	22594-86-1	343	28240-66-6	279	35138-22-8	349
19236-15-8	170	22673-19-4	434	28240-68-8	258	35138-23-9	86
19333-10-9	410	22691-02-7	35	28240-69-9	258	35193-64-7	252
19372-44-2	34	22722-98-1	417	28407-51-4	358	35344-11-7	110
19423-76-8	41	22825-00-9	218	28595-67-7	69	35369-53-0	197
19423-81-5	66	22831-39-6	123	28883-63-8	407	35542-88-2	126
19423-86-0	433	22992-83-2	61	28903-71-1	50	35625-75-3	439
19423-87-1	447	23032-93-1	347	28923-39-9	175	35679-81-3	236
19429-30-2	435	23039-97-6	277	28926-65-0	331	35725-30-5	60
19446-52-7	113	23108-72-7	75	29046-78-4	175	35725-34-9	447
19469-07-9	108	23190-16-1	178	29170-99-8	11	35733-23-4	62
19513-05-4	125	23293-23-4	122	29841-69-8	198	36042-94-1	311
19529-00-1	394	23301-82-8	402	29892-37-3	74	36042-99-6	278
19530-02-0	458	23363-14-6	449	29934-17-6	238	36548-87-5	433
19559-06-9	445	23364-44-5	178	29935-35-1	117	36554-90-2	80
19567-78-3	418	23519-77-9	458	29949-64-2	311	36620-11-8	355
19583-77-8	418	23582-02-7	268	29949-69-7	283	36802-41-2	278
19584-30-6	361	23582-03-8	331	29949-72-2	286	36809-75-3	436
19598-90-4	67	23586-53-0	432	29949-84-6	332	36885-29-7	34
19648-88-5	114	23670-45-3	54	29949-85-7	326	36885-30-0	422
19756-04-8	456	23743-26-2	258	29964-62-3	237	36885-31-1	12
19766-89-3	418	23897-15-6	332	30745-55-2	2	36907-37-6	113
19782-68-4	77	23906-97-0	83	31011-57-1	440	36907-40-1	62
19824-55-6	77	23927-40-4	39	31126-95-1	359	37002-45-2	39
19824-56-7	445	23936-60-9	265	31277-98-2	227	37002-48-5	269
19824-58-9	177	24304-00-5	2	31355-55-2	138	37095-27-5	72
19824-59-0	429	24356-01-2	456	31366-25-3	428	37170-64-2	258
19978-61-1	237	24363-37-9	12	31406-67-4	77	37260-88-1	76
19999-87-2	173	24444-72-2	111	31570-04-4	331	37299-12-0	46
20219-33-4	430	24598-62-7	5	31886-51-8	172	37342-97-5	454
20332-10-9	435	24621-61-2	215	31904-29-9	100	37366-09-9	382
20344-49-4	159	24646-85-3	445	31904-34-4	102	37473-67-9	170
20398-06-5	432	25032-49-9	290	32005-36-0	227	37912-25-7	427
20427-56-9	398	25102-12-9	199	32093-39-3	4	37943-90-1	309
20439-47-8	193	25114-58-3	79	32248-43-4	402	37988-38-8	207
20445-94-7	83	25201-30-3	128	32305-98-9	269	38245-35-1	60
20491-53-6	310	25360-32-1	369	32627-01-3	357	38245-36-2	66
20548-54-3	36	25470-96-6	356	32673-25-9	288	38245-38-4	169
20601-83-6	128	25476-27-1	420	32679-03-1	86	38582-18-2	452
20634-12-2	339	25487-66-5	26	32740-79-7	398	38596-61-1	368
20654-56-2	415	25519-09-9	78	32876-92-9	454	38625-54-6	401
20662-14-0	403	25583-20-4	442	32877-00-2	136	38685-12-0	340
20667-12-3	414	25658-42-8	458	32992-96-4	365	38704-78-8	366
20717-86-6	439	25753-84-8	55	32993-05-8	376	38998-79-7	397
20765-98-4	359	25764-08-3	41	33100-27-5	215	39050-26-5	209
20816-12-0	213	25767-20-8	191	33114-15-7	177	39207-65-3	219
21041-93-0	49	25895-60-7	417	33309-88-5	228	39330-74-0	62
21050-13-5	281	25955-51-5	432	33354-75-5	211	39373-27-8	359
21109-95-5	12	25979-07-1	282	33454-82-9	118	39380-74-0	175
21319-43-7	114	26006-71-3	421	33494-80-3	341	39409-82-0	122
21324-39-0	418	26042-63-7	414	33571-43-6	173	39430-51-8	45
21324-40-3	117	26042-64-8	414	33725-74-5	7	39470-10-5	62
21351-79-1	43	26077-31-6	414	33989-10-5	59	39648-67-4	252
21361-35-3	121	26088-25-5	329	34041-09-3	138	39864-68-1	295
21430-85-3	337	26134-62-3	118	34054-55-2	449	39929-21-0	74
21436-03-3	193	26220-72-4	52	34171-69-2	345	40244-90-4	310
21645-51-2	2	26305-75-9	48	34202-69-2	64	40650-31-5	38
21651-19-4	437	26317-70-4	363	34228-15-4	68	40691-33-6	239

CAS Registry Index

CAS No.	Page	CAS No.	Page	CAS No.	Page	CAS No.	Page
41066-45-9	343	56713-38-3	431	66534-97-2	268	78068-85-6	63
41203-22-9	209	56792-69-9	51	67108-80-9	455	78205-93-3	76
41396-69-4	87	56797-01-4	41	67292-34-6	174	78234-36-3	444
41536-18-9	100	56977-92-5	355	67292-36-8	51	78355-59-6	353
41575-94-4	337	57197-55-4	172	67506-86-9	125	78579-61-0	221
41587-84-2	175	57298-42-7	125	67579-81-1	197	78751-36-7	428
41612-46-8	93	57731-40-5	67	67874-71-9	23	79019-60-6	172
41625-30-3	270	57804-25-8	113	67884-32-6	270	79060-88-1	421
41706-15-4	177	58097-69-1	440	68193-40-8	455	79255-71-3	353
41836-28-6	448	58356-65-3	127	68193-45-3	76	79269-71-9	439
42075-32-1	220	58628-40-3	455	68424-71-5	122	79271-56-0	411
42196-31-6	248	58656-04-5	326	68553-60-6	446	79376-38-8	439
43077-29-8	316	59061-53-9	453	68683-17-0	449	79827-25-1	415
44843-38-1	186	59163-91-6	109	68683-18-1	414	79917-90-1	81
46360-78-5	349	59592-31-3	190	68832-13-3	207	79973-42-5	47
47814-18-6	170	59653-66-6	206	68938-72-7	202	80049-61-2	400
47814-20-0	345	59738-27-1	361	68957-94-8	330	80262-44-8	192
49540-00-3	128	59831-02-6	238	68959-87-5	113	80289-21-0	55
49596-04-5	455	60239-18-1	207	69021-85-8	170	80499-19-0	272
49676-42-8	331	60261-46-3	306	69021-86-9	346	80510-03-8	212
50315-14-5	57	60398-55-2	269	69039-11-8	429	80510-04-9	279
50446-44-1	221	60627-09-0	41	69056-62-8	83	80655-81-8	216
50525-27-4	401	60633-21-8	287	69207-83-6	122	80907-56-8	401
50595-38-5	268	60648-70-6	337	69227-47-0	331	81029-06-3	3
50777-76-9	303	60804-75-3	401	69365-72-6	68	81290-20-2	411
50960-82-2	73	60871-83-2	123	69477-27-6	191	81849-60-7	447
50982-12-2	391	60871-84-3	176	69507-98-8	115	82061-21-0	118
51064-65-4	39	60969-19-9	432	69550-28-3	74	82066-37-3	45
51094-78-1	429	61247-57-2	177	69739-34-0	406	82149-18-6	422
51203-49-7	439	61346-75-6	44	69861-71-8	229	82164-75-8	328
51274-00-1	108	61420-92-6	338	69912-79-4	135	82495-67-8	258
51319-99-4	436	61443-54-7	433	70197-13-6	347	82660-97-7	360
51364-51-3	249	61478-28-2	306	70317-91-8	107	83528-85-2	110
51411-03-1	346	61478-29-3	306	70693-62-8	343	83605-44-1	401
51429-74-4	138	61565-07-9	61	70955-01-0	135	84365-55-9	440
51641-96-4	128	61788-69-0	46	71042-54-1	267	84573-73-9	62
51805-45-9	331	61788-71-4	175	71042-55-2	267	84680-95-5	95
51850-20-5	337	61789-36-4	35	71360-06-0	264	84783-64-2	267
51905-34-1	118	61789-51-3	49	71397-33-6	376	84821-53-4	366
52013-36-2	94	61790-20-3	449	71414-47-6	429	85017-77-2	48
52090-23-0	309	62010-10-0	458	71423-54-6	355	85417-41-0	331
52093-25-1	63	62086-04-8	437	71626-98-7	35	85594-02-1	125
52093-26-2	113	62199-57-9	407	71626-99-8	35	85685-99-0	270
52093-27-3	346	62336-24-7	281	72345-23-4	220	85908-78-7	365
52093-28-4	402	62638-04-4	414	72598-03-9	306	85959-83-7	76
52093-29-5	67	62667-64-5	62	72914-19-3	181	86050-32-0	455
52093-30-8	450	62811-75-0	432	73138-26-8	124	86688-08-6	38
52193-54-1	207	62927-99-5	137	73183-34-3	24	87532-69-2	273
52462-29-0	383	62993-85-5	428	73227-23-3	169	87778-95-8	412
52462-31-4	392	63231-67-4	409	73364-08-6	455	88189-03-1	24
52490-94-5	391	63231-69-6	135	73364-10-0	454	88863-33-6	423
52495-41-7	421	63356-25-2	42	73450-43-8	99	90076-67-8	345
52522-40-4	249	63370-90-1	78	73468-85-6	358	91159-11-4	273
52785-06-5	338	63470-53-1	75	73482-96-9	359	91608-15-0	332
53199-31-8	228	63782-74-1	340	73491-34-6	128	91742-21-1	421
53293-32-6	439	63936-85-6	233	73491-36-8	433	92149-07-0	197
53317-87-6	76	63995-70-0	332	74507-61-2	44	92361-49-4	379
53535-81-2	117	63995-75-5	309	74507-63-4	172	92390-26-6	376
53597-69-6	325	64065-08-3	265	74507-64-5	121	92669-43-7	370
53633-79-7	123	64417-12-5	40	74641-30-8	181	93280-44-5	47
53823-60-2	418	64417-98-7	458	74663-77-7	184	93379-48-7	218
54010-75-2	454	64424-12-0	112	74866-28-7	38	93558-77-1	178
54039-38-2	455	64443-05-6	59	74974-60-0	68	93634-87-8	282
54451-25-1	40	64536-78-3	93	74974-61-1	3	94442-22-5	339
54575-49-4	345	64896-28-2	267	75181-07-6	456	94928-86-8	93
54656-96-1	203	64916-48-9	248	75181-08-7	77	95408-38-1	102
54678-23-8	56	65013-26-5	281	75732-01-3	59	95408-45-0	236
54723-94-3	6	65086-12-6	84	75777-87-6	401	95464-05-4	238
55102-19-7	378	65090-77-9	422	75965-35-4	118	96183-46-9	270
55120-75-7	36	65283-60-5	216	76089-77-5	42	96317-72-5	7
55172-98-0	12	65353-51-7	338	76189-55-4	267	96503-27-4	392
55658-96-3	346	65355-00-2	220	76189-56-5	267	96556-05-7	211
55739-58-7	278	65355-08-0	217	76858-94-1	266	97170-94-0	348
55940-03-9	44	65355-14-8	220	76926-16-4	425	97239-80-0	98
56183-63-2	272	65420-68-0	257	77291-90-8	219	97262-98-1	339
56553-60-7	421	66127-00-2	208	77450-05-6	306	97674-02-7	437
56678-60-5	87	66349-80-2	76	77876-39-2	270	97739-46-3	324

CAS Registry Index

CAS No.	Page	CAS No.	Page	CAS No.	Page	CAS No.	Page
97858-62-3	278	119386-71-9	185	136705-63-0	274	151139-14-9	113
98327-87-8	267	119445-90-8	455	136705-64-1	262	151670-69-8	180
98546-51-1	27	119707-74-3	216	136705-65-2	273	151888-20-9	279
99326-34-8	349	120156-44-7	174	136705-66-3	220	152248-67-4	439
99492-72-5	417	120156-45-8	122	136705-70-9	350	153608-51-6	61
99604-67-8	400	120666-13-9	329	136705-72-1	354	153725-04-3	307
99611-53-7	107	120967-70-6	357	136705-75-4	351	154358-50-6	328
99646-28-3	275	121009-93-6	456	136705-77-6	349	154940-96-2	440
99685-96-8	37	121627-17-6	287	136735-95-0	265	155613-52-8	283
99897-61-7	378	121758-19-8	199	136779-26-5	265	155806-35-2	104
100080-82-8	456	121898-64-4	332	136779-27-6	262	155830-69-6	103
100163-29-9	456	121954-50-5	258	136779-28-7	262	157018-15-0	219
100165-88-6	275	122528-16-9	42	136802-85-2	263	157197-53-0	195
100587-90-4	112	122709-72-2	305	136946-83-3	407	157197-54-1	194
100587-91-5	402	123287-35-4	218	137037-20-8	179	157282-19-4	284
100587-96-0	431	123333-45-9	228	137156-22-0	283	157488-65-8	302
100603-32-5	213	123333-66-4	344	137219-86-4	276	157772-65-1	354
100786-00-3	327	123334-20-3	446	137349-65-6	258	158214-06-3	316
101200-05-9	34	123334-23-6	418	137536-94-8	218	158923-09-2	101
101203-31-0	221	123334-29-2	48	138124-32-0	125	158923-11-6	101
101923-26-6	125	123927-75-3	440	138517-61-0	285	161265-03-8	298
101932-75-6	125	124779-66-4	179	139139-86-9	270	162157-03-1	102
102525-11-1	90	125572-95-4	193	139139-93-8	270	162291-01-2	101
102691-36-1	283	126250-68-8	347	139143-09-2	199	162291-02-3	104
103470-68-4	449	126320-57-8	208	139177-62-1	60	162412-87-5	97
103933-26-2	138	126456-43-7	178	139177-63-2	79	162412-90-0	350
104439-77-2	397	126613-06-7	214	139177-64-3	61	162978-03-2	432
104499-08-3	201	126683-99-6	284	139220-25-0	137	163169-29-7	110
104619-10-5	158	126857-69-0	119	140681-55-6	191	163959-79-3	203
105333-10-6	235	126949-63-1	137	141096-35-7	308	164297-25-0	111
106224-36-6	248	126949-65-3	137	141478-68-4	433	164528-22-7	170
106245-43-6	100	127593-28-6	237	141553-09-5	179	164858-78-0	308
106294-60-4	86	128008-30-0	80	141556-42-5	189	164931-83-3	46
106308-26-3	274	128249-70-7	187	141556-45-8	189	165257-90-9	432
106678-35-7	55	128544-05-8	215	141556-46-9	181	165324-09-4	36
106681-15-6	381	128575-71-3	138	141686-21-7	378	165461-74-5	415
106705-37-7	423	129212-21-1	219	142128-92-5	215	165612-19-1	347
107263-95-6	200	129619-37-0	220	142184-30-3	349	165688-64-2	455
107264-00-6	200	129648-07-3	265	142421-57-6	275	166172-63-0	98
107333-47-1	443	130004-33-0	373	142617-53-6	24	166330-10-5	270
108203-89-0	81	130225-27-3	111	142691-70-1	95	166439-15-2	362
108503-47-5	452	130433-68-0	195	142962-95-6	380	166445-62-1	239
109088-11-1	341	130521-76-5	62	144026-79-9	403	166764-19-8	185
109313-83-9	97	131042-77-8	180	144119-12-0	202	167261-43-0	179
109998-76-7	337	131042-78-9	180	144222-34-4	210	167316-27-0	210
110529-22-1	202	131159-39-2	37	144665-26-9	440	167416-28-6	101
110802-84-1	91	131211-27-3	284	145214-57-9	262	167709-31-1	260
111795-43-8	216	131266-79-0	284	145214-59-1	262	168106-22-7	12
111982-81-1	269	131274-22-1	326	145238-45-5	29	168106-25-0	452
112022-81-8	29	131457-46-0	187	145381-23-3	391	169051-76-7	82
112022-83-0	28	131614-43-2	375	145698-90-4	392	169051-77-8	82
112193-83-6	179	131864-67-0	188	145926-28-9	373	169689-05-8	285
112379-49-4	12	131890-26-1	273	145964-33-6	305	169896-41-7	428
112521-97-8	306	132071-87-5	386	146476-37-1	303	170709-41-8	199
112926-00-8	133	132644-88-3	92	146960-90-9	95	171899-61-9	369
112945-52-5	410	132682-77-0	306	147253-67-6	265	172138-95-3	194
113822-11-0	240	132723-93-4	179	147253-69-8	273	172418-32-5	235
113860-02-9	400	133395-16-1	122	147702-13-4	219	172424-98-5	42
113860-07-4	379	133545-16-1	268	147702-14-5	219	173035-10-4	189
113978-91-9	326	133545-17-2	268	147702-15-6	219	173035-11-5	189
114026-76-5	218	133545-24-1	275	147702-16-7	219	173416-05-2	338
114460-02-5	120	133545-25-2	275	147762-89-8	95	173831-50-0	215
114504-74-4	121	133850-81-4	267	147831-75-2	379	174467-31-3	96
114615-82-6	8	134108-76-2	201	148347-90-4	455	174500-20-0	187
114751-47-2	305	134484-36-9	305	148369-91-9	185	174501-65-6	81
114757-66-3	227	134524-84-8	386	148432-44-4	301	174677-83-9	266
115383-22-7	37	135113-15-4	37	148461-14-7	308	174758-63-5	266
115804-59-6	158	135113-16-5	37	148630-66-4	415	174810-09-4	285
115826-95-4	237	135139-00-3	276	148980-31-8	431	174813-81-1	371
116128-29-1	381	135616-36-3	193	149160-45-2	13	174813-82-2	371
117106-39-5	187	135616-40-9	193	149646-83-3	299	174899-82-2	82
117903-79-4	187	135620-04-1	125	149796-59-8	235	175136-62-6	330
117903-80-7	181	136030-00-7	178	149968-36-5	257	175845-21-3	330
118131-57-0	11	136040-19-2	31	150024-49-0	38	175923-04-3	457
118448-18-3	34	136316-32-0	37	150939-76-7	422	175923-07-6	113
118612-00-3	27	136629-60-2	13	150971-43-0	273	176726-07-1	403
118949-61-4	188	136705-62-9	262	150971-45-2	273	176763-62-5	51

CAS Registry Index

CAS No.	Page	CAS No.	Page	CAS No.	Page	CAS No.	Page
177279-28-6	415	213697-53-1	293	282109-83-5	183	374067-51-3	380
178879-60-2	360	213843-90-4	300	284472-79-3	302	374683-35-9	83
179162-34-6	360	214348-95-5	201	286014-38-8	181	374683-44-0	84
179866-74-1	217	214360-60-8	29	286454-86-2	303	376355-58-7	279
180516-87-4	29	214360-73-3	29	288574-78-7	191	380230-02-4	301
181418-64-4	443	214360-76-6	30	290347-66-9	95	384842-24-4	291
181864-78-8	293	215788-65-1	238	290347-88-5	350	384842-25-5	287
184032-07-3	343	215863-85-7	124	292638-88-1	98	387827-64-7	196
184095-69-0	104	216064-20-9	391	293293-33-1	111	387859-70-3	93
185036-38-8	125	216299-76-2	82	297752-25-1	317	389130-06-7	317
185346-09-2	182	217459-10-4	110	300344-02-9	137	394248-45-4	277
185449-80-3	302	217459-11-5	110	301847-89-2	268	395116-70-8	251
185449-81-4	302	218290-24-5	194	302924-37-4	382	396654-07-2	40
185449-86-9	298	219143-92-7	46	305818-67-1	351	401788-98-5	81
185812-86-6	236	219770-99-7	366	307926-51-8	3	402846-78-0	81
185827-91-2	55	219852-96-7	445	308068-56-6	148	403815-19-0	94
185913-97-7	291	220114-01-2	390	308080-99-1	135	405235-55-4	85
185913-98-8	291	220114-03-4	390	308103-54-0	441	406462-43-9	443
186598-40-3	405	220114-32-9	390	308103-66-4	279	406680-94-2	104
187682-63-9	351	220114-38-5	390	308847-85-0	67	406681-09-2	104
187682-64-0	102	220182-83-2	424	309735-86-2	396	411235-57-9	26
188264-84-8	51	221012-82-4	323	312696-25-6	431	415918-91-1	301
189114-61-2	414	223259-62-9	220	312739-77-8	448	415941-58-1	298
190848-36-3	201	224311-49-3	289	312959-24-3	110	422509-53-3	302
192057-60-6	308	224311-51-7	288	321921-71-5	282	428514-91-4	306
192138-05-9	260	225931-80-6	229	322407-34-1	179	429678-11-5	382
192139-90-5	370	228120-95-4	375	325146-81-4	380	434336-16-0	258
192139-92-7	370	228121-39-9	349	325150-57-0	391	436863-50-2	95
192463-40-4	270	229177-79-1	266	325168-88-5	277	436865-11-1	283
195062-62-5	27	230299-21-5	24	325168-89-6	277	442905-33-1	324
196929-78-9	424	233664-53-4	340	325810-07-9	59	443150-11-6	331
197389-47-2	440	240417-00-9	304	328090-25-1	82	443347-10-2	324
198422-64-9	201	244187-81-3	184	328123-04-2	440	443965-10-4	321
199445-30-2	422	244193-50-8	82	329371-25-7	376	443965-14-8	321
199541-17-8	395	244193-52-0	83	329735-68-4	221	444910-17-2	239
199684-47-4	395	244261-66-3	266	329735-69-5	44	445460-78-6	198
200284-92-0	172	245679-18-9	189	329735-73-1	449	445467-61-8	271
200808-73-7	353	246231-77-6	101	329735-75-3	455	445473-58-5	81
201611-77-0	427	246231-79-8	99	329735-77-5	137	447440-43-9	405
201611-85-0	425	247923-41-7	178	329735-79-7	366	452304-59-5	303
201611-92-9	425	247940-06-3	292	329735-86-6	384	452304-63-1	303
201733-56-4	24	248277-14-7	218	329735-87-5	385	460092-03-9	83
203065-88-7	210	248924-59-6	29	329736-05-2	385	461642-78-4	426
203863-17-6	35	250220-36-1	366	329736-06-3	77	465527-59-7	83
204203-14-5	184	250285-32-6	184	330793-01-6	26	465527-65-5	84
204933-84-6	396	250611-13-3	3	331465-71-5	326	467220-49-1	229
205064-10-4	350	251320-86-2	294	331465-73-7	212	470688-18-7	377
205319-06-8	238	251984-08-4	42	336879-56-2	434	477284-75-6	410
205319-10-4	239	252288-04-3	302	338800-13-8	257	478308-91-7	393
205495-66-5	285	252976-51-5	448	339527-86-5	344	478308-93-9	393
205497-64-9	311	254972-49-1	399	341483-76-9	361	478980-01-7	226
205815-80-1	137	255836-67-0	288	341968-71-6	250	478980-03-9	226
205927-03-3	221	255837-19-5	289	342573-75-5	82	478980-04-0	226
206564-87-6	177	255874-48-7	259	343338-28-3	424	479687-23-5	427
207121-39-9	58	255897-36-0	258	344790-86-9	82	480424-68-8	30
207569-11-7	175	256235-61-7	276	345612-63-7	208	480424-70-2	30
207611-58-3	38	256390-47-3	276	346457-41-8	395	480424-71-3	26
207683-21-4	421	258278-25-0	183	350683-75-9	340	480438-74-2	26
207683-22-5	421	258278-28-3	183	351994-94-0	426	486429-99-6	268
207788-38-3	450	258864-54-9	84	352535-01-4	78	488809-34-3	395
207801-29-4	449	259886-49-2	192	352655-40-4	261	490023-37-5	301
210057-23-1	350	259886-50-5	192	352655-61-9	260	494199-72-3	289
210169-40-7	260	259886-51-6	192	359803-53-5	233	494227-30-4	97
210169-54-3	266	261733-18-0	270	360048-63-1	97	494227-35-9	96
210169-57-6	276	261948-85-0	380	362524-23-0	323	494227-36-0	97
210363-27-2	177	262280-80-8	212	362634-22-8	277	494227-37-1	96
210537-32-9	186	263163-17-3	181	364732-86-5	278	498580-48-6	103
210758-43-3	12	267431-79-8	197	364732-88-7	270	500103-26-4	278
211560-97-3	217	269409-70-3	30	364795-64-2	391	500295-52-3	93
212133-11-4	392	269409-73-6	29	365215-38-9	180	500995-67-5	119
212143-23-2	384	269409-97-4	30	365549-33-33	214	500997-69-3	321
212143-24-3	384	269409-99-6	27	369405-27-6	198	500997-70-6	321
212210-87-2	385	269410-00-6	27	369657-32-9	94	502467-23-4	190
212611-88-6	187	269410-08-4	30	370878-69-6	83	502964-52-5	368
213343-64-7	349	269410-22-2	27	373650-12-5	380	503538-68-9	271
213343-65-8	351	269410-25-5	27	374067-49-9	381	503538-69-0	271
213343-67-0	354	277306-29-3	103	374067-50-2	381	503538-70-3	271

CAS Registry Index

CAS No.	Page	CAS No.	Page	CAS No.	Page	CAS No.	Page
506417-41-0	382	745038-86-2	124	857637-92-4	179	929097-93-8	314
510758-28-8	212	749935-02-2	396	857678-55-8	388	929294-27-9	281
511292-99-2	429	756824-22-3	94	858116-31-1	387	930601-66-4	363
521272-85-5	353	765278-73-7	217	858971-43-4	228	931098-92-9	196
528521-86-0	272	776230-17-2	363	861909-53-7	263	932710-63-9	298
528521-87-1	264	776315-37-8	99	862095-91-8	197	934302-16-6	114
528521-89-3	261	776316-48-4	277	863971-62-4	369	934538-04-2	367
528565-79-9	272	783321-71-1	82	863971-63-5	369	934538-12-2	367
528565-84-6	353	783334-85-0	415	863971-66-8	289	934621-82-6	84
528814-26-8	291	787618-22-8	293	864079-62-9	407	935449-46-0	394
528854-34-4	274	791114-66-4	445	864079-63-0	407	937378-18-2	291
532980-53-3	408	791616-55-2	281	864943-23-7	314	940880-69-3	187
536724-67-1	400	791616-56-3	314	865488-44-4	378	940895-79-4	172
540475-45-4	97	791616-59-6	313	866081-62-1	255	942939-38-0	301
540475-73-8	98	791616-62-1	254	866267-84-7	182	944450-43-5	389
540492-51-1	310	791616-63-2	313	866395-16-6	76	944450-44-6	389
540492-55-5	358	791616-65-4	317	866641-66-9	74	944450-45-7	389
541540-70-9	110	791629-96-4	87	866926-59-2	199	944450-46-8	389
544461-38-3	96	793718-16-8	96	868851-50-7	309	944450-48-0	380
546084-25-7	406	794527-14-3	328	870077-94-4	91	944450-49-1	381
550373-32-5	258	796045-97-1	425	870196-80-8	424	944450-50-4	381
556797-94-5	272	799297-44-2	250	870196-83-1	425	944451-08-5	394
558445-90-2	205	804559-39-5	405	870245-84-4	293	944451-10-9	394
564483-18-7	295	808142-80-5	90	870777-30-3	287	944451-12-1	396
564483-19-8	290	817176-80-0	265	870987-63-6	90	944451-14-3	394
565184-29-4	104	817575-04-5	83	870987-64-7	90	944451-24-5	375
565184-32-9	104	817575-06-7	83	870991-70-1	185	944451-25-6	375
565184-33-0	104	821009-34-1	102	871126-33-9	180	944451-26-7	374
566940-03-2	259	821793-33-3	377	871210-22-9	206	944451-27-8	374
569650-64-2	354	821793-35-5	377	872143-57-2	196	944451-28-9	371
573718-56-6	360	821793-36-6	393	873585-38-7	451	944451-29-0	372
577971-19-8	225	821793-37-7	393	874013-62-4	55	944451-30-3	375
578743-87-0	56	824395-67-7	272	874881-81-9	341	944451-31-4	375
583052-21-5	196	828914-68-7	197	874948-59-1	314	944451-32-5	371
583844-38-6	85	828927-94-2	307	874948-60-4	314	944451-33-6	371
603109-48-4	91	828927-95-3	307	874948-63-7	314	944710-34-3	257
607389-84-4	103	828927-96-4	307	878111-17-2	254	945491-51-0	88
610304-81-9	290	828927-97-5	307	878111-20-7	281	945852-48-2	317
612492-27-0	217	831226-39-2	96	880262-14-6	85	946607-10-9	194
614753-51-4	233	839722-07-5	73	880262-16-8	85	947402-57-5	295
619334-93-9	354	847616-85-7	229	884879-23-6	234	947402-60-0	294
620960-26-1	188	847997-73-3	96	884879-24-7	234	947515-50-6	204
625832-70-4	121	849773-96-2	354	885701-71-3	322	951776-24-2	72
628323-64-8	304	849950-53-4	353	885701-78-0	313	952518-08-0	60
628333-86-8	289	849950-54-5	98	886059-84-3	287	952586-19-5	106
628339-96-8	227	849950-56-7	353	887919-35-9	237	952649-12-6	327
629654-53-1	428	850253-53-1	276	887938-70-7	194	958004-03-0	186
635680-56-7	95	850444-36-9	103	890090-21-8	187	958004-04-1	204
635680-58-9	47	851051-43-9	397	894086-00-1	290	958004-05-2	182
638132-66-8	299	851308-40-2	102	894423-99-5	397	958004-12-1	188
647036-07-5	51	851308-43-5	103	894771-25-6	105	959395-07-4	188
649559-66-0	102	851308-45-7	105	894771-28-9	105	959395-10-9	99
649736-75-4	228	851308-47-9	103	896733-61-2	72	959698-19-2	226
654057-97-3	84	851308-48-0	105	897665-73-5	330	959864-38-1	271
656233-53-3	322	851477-20-8	188	899811-43-9	98	959864-39-2	324
657408-07-6	292	851729-55-0	425	900505-82-0	98	960050-59-3	178
666826-16-0	86	851870-89-8	262	905982-78-7	191	960050-60-6	178
666856-94-6	273	851942-89-7	194	908128-78-9	352	960128-64-7	250
669091-00-3	264	852042-07-0	299	909389-99-7	359	1002345-50-7	259
672306-06-8	51	852212-92-1	178	909393-65-3	359	1003012-96-1	103
672937-60-9	318	852445-81-9	73	910134-30-4	260	1005340-01-1	218
672937-61-0	318	852445-82-0	73	912457-08-0	322	1007311-95-6	292
672937-63-2	315	852445-83-1	72	913196-43-7	308	1007311-98-9	291
676525-77-2	90	852445-84-2	73	913829-88-6	252	1011465-24-9	254
680592-40-9	406	852445-87-5	73	914089-00-2	101	1011477-51-2	47
695162-86-8	314	852445-88-6	73	917377-74-3	272	1019840-96-0	323
695188-31-9	54	852634-41-4	180	917377-75-4	261	1019852-99-3	93
695816-47-8	299	852913-53-2	196	917511-90-1	237	1019853-01-0	93
705945-70-6	355	854045-93-5	73	918870-76-5	367	1019853-03-2	91
714951-87-8	282	854045-95-7	74	918871-44-0	398	1020670-88-5	271
721427-58-3	91	854275-87-9	351	919338-66-2	261	1021176-69-1	295
721880-19-9	42	854920-90-4	351	922711-75-9	317	1021940-25-9	409
736158-72-8	277	854920-94-8	354	923956-62-1	136	1023330-38-2	291
740815-36-5	318	855996-83-7	411	924294-55-3	296	1025096-61-0	282
740815-37-6	318	856405-77-1	298	925689-54-9	203	1025476-84-9	380
740816-14-2	197	856407-37-9	313	928170-42-7	54	1025477-38-6	379
742103-27-1	287	857356-94-6	290	929097-92-7	281	1026785-83-0	408

CAS Registry Index

CAS No.	Page	CAS No.	Page	CAS No.	Page	CAS No.	Page
1026995-71-0	370	1160555-04-3	186	1228032-35-6	181	1361146-90-8	323
1026995-72-1	370	1160556-63-7	182	1228077-88-0	188	1361315-26-5	99
1028206-56-5	232	1160556-64-8	292	1228169-92-3	367	1361318-83-3	379
1028206-58-7	231	1160707-20-9	378	1228185-09-8	183	1361415-88-4	378
1028206-60-1	232	1160861-53-8	288	1231763-32-8	202	1365531-75-4	272
1034343-98-0	146	1160861-59-5	284	1233717-68-4	227	1365531-76-5	272
1034449-15-4	195	1160861-60-8	285	1235024-08-4	206	1365531-81-2	275
1034537-36-4	113	1166994-77-9	295	1235825-84-9	5	1365531-82-3	275
1036248-62-0	199	1166994-78-0	294	1235960-36-7	190	1365531-84-5	255
1036373-39-3	106	1167987-07-6	194	1237588-12-3	284	1365531-85-6	255
1037287-79-8	201	1169835-86-2	323	1239877-06-5	184	1365531-89-0	253
1037287-81-2	200	1170736-59-0	263	1239877-07-6	185	1365531-90-3	253
1038932-67-0	355	1173836-08-2	307	1240328-73-7	72	1365531-93-6	254
1040274-10-9	252	1174131-02-2	360	1242066-20-1	317	1365531-94-7	254
1042093-98-0	58	1174218-30-4	355	1242168-77-9	316	1365531-98-1	253
1044256-04-3	299	1185899-00-6	293	1242759-01-8	315	1365531-99-2	253
1049726-96-6	292	1186392-32-4	300	1245785-21-0	423	1366384-12-4	303
1053657-14-9	310	1186392-43-7	300	1252661-94-1	51	1372124-93-0	189
1053658-84-6	289	1186602-28-7	188	1257252-03-1	99	1372719-93-1	322
1053658-91-5	315	1187446-93-0	322	1257379-83-1	107	1373349-83-7	324
1053659-64-5	297	1188406-04-3	124	1258327-01-3	215	1375325-64-6	231
1055301-14-8	185	1188507-66-5	74	1258327-07-9	255	1375325-68-0	232
1055888-89-5	290	1190427-49-6	399	1258964-46-3	87	1375325-71-5	235
1065214-95-0	264	1190427-50-9	400	1258964-48-5	88	1375325-77-1	233
1067175-36-3	292	1190427-51-0	399	1262046-34-3	289	1380079-15-1	299
1067883-58-2	295	1192483-03-6	364	1262545-44-7	72	1380313-48-3	426
1067889-87-5	269	1192483-14-9	363	1264573-23-0	313	1380314-24-8	234
1070663-78-3	293	1192483-19-4	364	1268357-44-3	434	1384974-37-1	396
1070876-63-9	405	1192483-26-3	364	1268693-24-8	250	1384974-38-2	376
1072220-37-1	405	1192483-27-4	364	1268824-70-9	309	1389300-54-9	258
1072413-80-9	457	1192620-83-9	397	1280199-86-1	52	1391410-56-2	312
1080030-13-2	253	1193697-61-8	317	1280730-21-3	387	1391512-50-7	179
1084898-23-6	190	1194050-19-5	89	1280732-29-7	387	1391532-95-8	427
1086138-36-4	256	1194050-21-9	89	1286189-16-9	215	1396201-63-0	87
1091606-63-1	426	1194050-23-1	89	1287255-62-2	386	1398565-95-1	294
1091606-65-3	426	1195511-56-8	89	1289463-79-1	280	1400149-69-0	303
1091606-66-4	427	1195511-59-1	89	1289463-82-6	279	1401708-91-5	55
1091606-67-5	304	1196118-15-6	249	1289463-84-8	279	1404433-37-9	205
1091606-68-6	304	1196147-57-5	383	1289463-87-1	281	1407229-58-6	368
1091606-69-7	304	1196147-60-0	382	1289463-91-7	276	1412439-82-7	265
1091606-70-0	303	1196147-69-9	310	1289463-93-9	280	1413732-47-4	59
1092064-02-2	297	1196147-72-4	290	1293372-65-2	426	1414707-08-6	367
1092064-04-4	297	1196467-26-1	383	1295649-40-9	369	1415636-82-6	257
1092372-90-1	383	1196707-11-5	74	1295649-41-0	368	1416368-06-3	180
1092372-91-2	382	1198080-53-3	300	1297613-75-2	265	1418483-59-6	87
1092775-62-6	86	1198080-55-5	300	1297613-76-3	255	1419179-26-2	173
1097730-63-6	376	1198080-57-7	251	1298133-21-7	257	1421060-10-7	368
1097731-98-0	383	1202865-03-9	311	1298133-26-2	257	1421060-11-8	368
1101230-25-4	376	1202865-21-1	256	1298133-36-4	256	1421599-46-3	434
1101230-28-7	273	1203507-02-1	197	1298133-38-6	256	1422371-27-4	323
1103533-85-2	308	1204324-14-0	198	1299489-47-6	452	1426397-81-0	297
1106696-25-6	326	1204324-18-4	196	1300746-79-5	59	1428328-51-1	181
1107608-80-9	255	1204324-20-8	196	1308652-64-3	294	1429939-31-0	261
1110711-01-7	286	1206227-45-3	424	1308652-65-4	310	1429939-32-1	264
1118114-88-7	189	1206227-46-4	427	1308652-66-5	296	1429939-35-4	260
1119821-62-3	54	1206227-47-5	426	1308652-67-6	307	1432793-97-9	206
1121960-90-4	73	1208092-27-6	86	1310584-14-5	232	1435467-29-0	182
1121960-93-7	76	1209467-60-6	427	1311164-69-8	368	1435520-65-2	226
1130784-80-3	250	1211417-77-4	197	1312582-16-3	392	1435940-19-4	285
1141464-90-5	186	1212008-99-5	365	1312713-89-5	376	1437326-26-5	378
1142811-12-8	231	1217463-35-8	201	1313012-94-0	94	1439402-25-1	88
1148148-01-9	231	1217655-83-8	296	1313705-92-8	424	1439556-82-7	269
1150112-42-7	372	1217887-12-1	328	1318882-54-0	111	1440435-00-6	189
1150112-44-9	374	1219080-77-9	284	1333981-84-2	378	1443051-87-3	385
1150112-46-1	374	1221745-90-9	100	1333981-86-4	379	1443051-97-5	387
1150112-53-0	373	1221746-31-1	100	1338245-54-7	237	1443051-98-6	386
1150112-54-1	373	1221746-56-0	110	1345974-62-0	359	1445085-55-1	245
1150112-55-2	373	1221746-66-2	110	1345974-63-1	359	1445085-77-7	244
1150112-86-9	372	1221768-92-8	86	1350767-15-5	288	1445085-82-4	243
1150112-87-0	372	1222630-32-1	304	1350770-63-6	217	1445085-87-9	244
1150113-55-5	382	1222630-36-5	306	1351279-73-6	220	1445085-92-6	242
1150113-65-7	274	1222630-45-6	250	1352633-94-3	363	1445085-97-1	246
1150113-66-8	282	1222630-50-3	310	1357562-63-0	298	1445086-12-3	246
1150592-91-8	252	1222630-51-4	250	1357562-70-9	281	1445086-17-8	241
1155422-69-7	399	1224727-08-5	274	1359986-21-2	289	1445086-28-1	240
1156547-61-3	101	1224879-40-6	227	1360823-43-3	269	1445972-29-1	241
1159850-42-6	94	1226076-44-0	261	1360949-97-8	379	1446713-81-0	92

CAS Registry Index

CAS No.	Page	CAS No.	Page
1447963-71-4	303	1858223-90-1	316
1447963-73-6	243	1858224-21-1	316
1447963-75-8	243	1858249-76-9	424
1448663-06-6	365	1867120-15-7	53
1448722-98-2	260	1884452-99-6	360
1451002-39-3	231	1884680-45-8	285
1452227-72-3	368	1902911-38-9	324
1456816-37-7	251	1902911-45-8	174
1469467-94-4	88	1905460-13-0	234
1469882-57-2	297	2009020-38-4	242
1470372-59-8	244	2049086-35-1	173
1493790-73-0	301	2049086-36-2	173
1501945-23-8	174	2049086-37-3	173
1507403-85-1	243		
1507403-89-5	242		
1508260-88-5	314		
1511859-41-8	233		
1514896-39-9	172		
1522117-80-1	29		
1522117-83-4	25		
1536473-72-9	242		
1537175-69-1	309		
1542135-29-4	52		
1548897-80-8	264		
1568043-19-5	178		
1574321-76-8	386		
1581285-85-9	247		
1583244-07-8	210		
1583244-12-5	211		
1583244-17-0	210		
1585988-92-6	322		
1599466-81-5	245		
1599466-83-7	244		
1599466-85-9	245		
1599466-87-1	244		
1599466-89-3	243		
1602922-03-1	240		
1607436-49-6	366		
1607469-49-7	86		
1621274-11-0	246		
1621274-19-8	246		
1647073-46-8	210		
1660153-91-2	282		
1663476-15-0	183		
1702311-34-9	245		
1702744-45-3	174		
1771755-22-6	106		
1779389-90-0	259		
1779569-01-5	230		
1779569-06-0	230		
1779569-07-1	230		
1779569-08-2	230		
1799401-51-6	259		
1799401-52-7	259		
1799401-53-8	259		
1799947-97-9	365		
1802015-49-1	297		
1805783-51-0	227		
1805783-60-1	284		
1807740-34-6	251		
1807948-77-1	174		
1808959-36-5	280		
1808959-38-7	280		
1808959-39-8	256		
1809609-38-8	319		
1809609-39-9	319		
1809609-40-2	319		
1809609-52-6	252		
1809609-53-7	311		
1810068-30-4	280		
1810068-31-5	280		
1820817-64-8	245		
1823273-83-1	425		
1823532-14-4	315		
1848244-75-6	294		
1858223-86-5	298		
1858223-87-6	251		

Equipment: Cylinders and Adapters

Caution!

Due to the hazardous nature of many of the materials packaged in metal cylinders, we strongly recommend that all users read the technical note associated with the catalog numbers below posted at strem.com carefully before using the product. The cylinders and valves are used primarily for the safe transport and storage of pyrophoric materials. As with any air-sensitive compound, the cylinder should be taken into an inert atmosphere bag or box to remove the product. If you are unsure of the handling procedures and need assistance, please contact the Operations & Logistics Manager at (978) 499-1600 (All countries) or (800) 647-8736 (USA & Canada only).

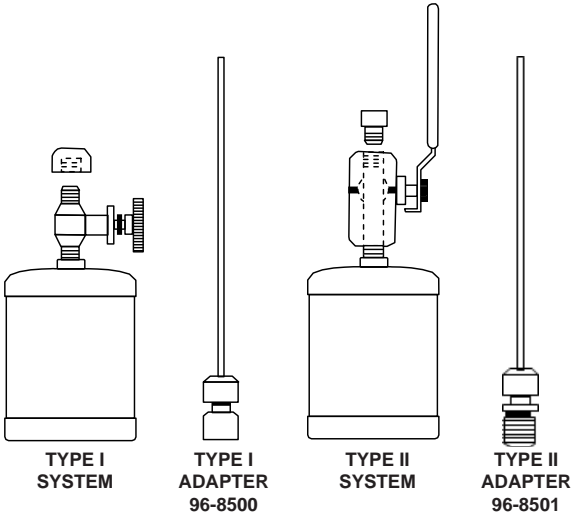

Cat #	Description
96-8500	Swagelok® Type I Adapter
96-8501	Swagelok® Type II Adapter
96-8105	Brass needle valve (Type I)
96-8100	Brass ball valve (Type II)
96-8000	Cylinder, carbon steel, 275 ml
96-8005	Cylinder, carbon steel, 900 ml

For instruction details on Type I or Type II systems please visit strem.com

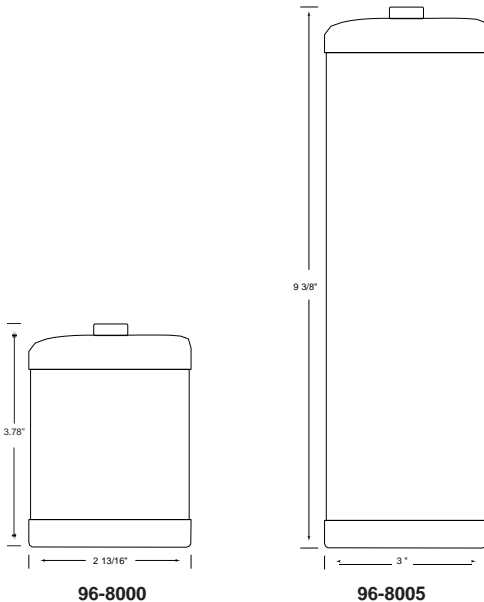

96-8000	
Contents:	275 ml
Design Pressure:	240 psig
Outlet Fitting:	1/4 NPTF pipe thread size
Weight:	0.7 lbs
Dimensions:	2 13/16" dia x 3 7/8"
D.O.T. Specs:	DOT-4 B240

96-8005	
Contents:	900 ml
Design Pressure:	240 psig
Outlet Fitting:	1/4 NPTF pipe thread size
Weight:	1.5 lbs
Dimensions:	3" dia x 9 3/8"
D.O.T. Specs:	DOT-4 B240ET

Chemical Vapor Deposition / Atomic Layer Deposition (CVD/ALD) Equipment

ALD CYLINDERS

Standard Assembly

96-1070 Swagelok® Cylinder Assembly, 50ml with 1/4" VCR Male Ball Valve and Female Nut for CVD/ALD

1/4" VCR Male Ball Valve rated to 300°F or 148°C

High-Temp Valve Assembly

96-1071 Swagelok® Cylinder Assembly, 50ml with 1/4" VCR Male Bellows-Sealed Valve (High Temp) and Female Nut for CVD/ALD

1/4" VCR Male Bellows-Sealed Valve (High Temp/EP) rated to 600°F or 315°C

Electropolished (EP) Assembly with Ball Valve or High-Temp Valve (Optional)

96-1075 Swagelok® Cylinder Assembly, 50ml with 1/4" VCR Male Ball Valve (SC-11 cleaned) and Female Nut, electropolished for CVD/ALD

1/4" VCR Male Ball Valve (EP) rated to 300°F or 148°C

96-1076 Swagelok® Cylinder Assembly, 50ml with 1/4" VCR Male Bellows-Sealed Valve (High Temp) and Female Nut, electropolished for CVD/ALD

1/4" VCR Male Bellows-Sealed Valve (High Temp/EP) rated to 600°F or 315°C

DP Valve Assembly

96-1077 Swagelok® Cylinder Assembly, 50ml with 1/4" VCR Male DP Valve (Ultra High Purity) and Female Nut, electropolished for CVD/ALD

1/4" VCR Male DP high pressure diaphragm Valve (Ultra High Purity/EP) rated to 50-320°F or 10-148°C

96-1078 Swagelok® Cylinder Assembly, 50ml with 1/4" VCR Male DP High Pressure Valve (High Purity), PCTFE seat, VCR Metal Gasket Seal Fitting, Round Handle

1/4" VCR Male DP high pressure diaphragm Valve (High Purity/EP) rated to 250°F or 121°C

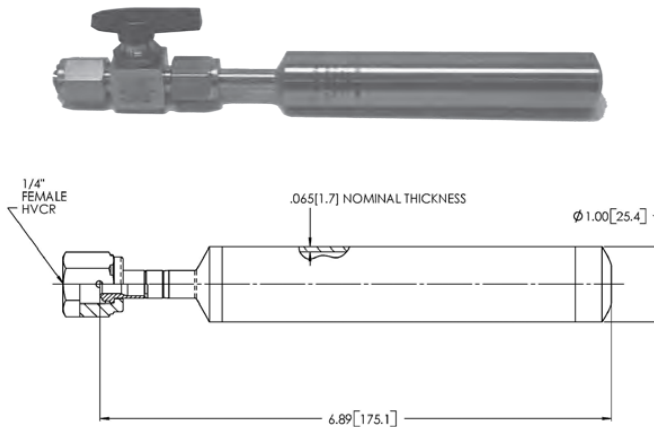

• Drawing is not to scale

• Dimensions are in inches [millimeters in brackets]

• Drawing subject to change without notice

Swagelok® Trademark is owned by Swagelok Company. Registered user in Canada: SWAGELOK Canada, Ltd. SWAGELOK AG is an authorized user in Switzerland of the SWAGELOK trademark.

New Cylinders for ALD

95-4154 Stainless steel cylinder, 200ml, single vertical stem, electropolished with fill-port, PCTFE valve stem tip, DOT 4B, UN stamped

PCTFE valve stem tip, 1/2" MVCR fill-port, SS-DSTW4 outlet valve, D.O.T specification: 4B-300

95-0281 Stainless steel cylinder, 125ml, horizontal in line, with angled Bellows valve (150°C), DOT 4B, UN stamped

Angled bellows valve, Fujikin, FUB-81-6.35-PI inlet valve, rated to -10 to 150°C, D.O.T. specification: 4B-260

Chemical Vapor Deposition / Atomic Layer Deposition (CVD/ALD) Equipment

STAINLESS STEEL BUBBLERS:

Vertical, Electropolished with fill-port, DOT4B, UN Stamped

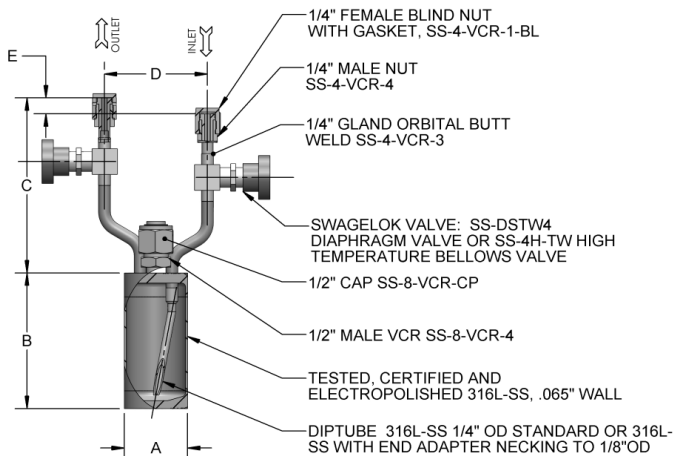

Stainless Steel Bubblers, vertical, electropolished with fill-port, PCTFE valve stem tip (121°C), DOT 4B, UN stamped

Catalog #	Vol. (mL)	A mm	B mm	C mm	D mm	E mm	Temp. Valve	Special Configuration
95-4151	150	51	108	143	83	13	Standard	
95-4290	300	51	187	143	83	13	Standard	
95-4598	600	76	164	143	83	13	Standard	
95-4998	1000	76	254	143	83	13	Standard	
95-5002	1200	102	184	143	83	13	Standard	
95-5003	1500	102	223	143	83	13	Standard	
95-5001	2000	102	292	143	83	13	Standard	
95-5011	3000	152	213	140	83	13	Standard	
95-3000	150	51	108	140	83	13	Standard	replaceable-seat valves with rotated handles
95-4153	150	51	108	143	83	13	Standard	with rotated handles

Stainless Steel Bubblers, vertical, electropolished with fill-port, high temperature valves (315°C), DOT 4B, UN stamped

Catalog #	Vol. (mL)	A mm	B mm	C mm	D mm	E mm	Temp. Valve	Special Configuration
95-0271	150	51	108	140	83	13	High	
95-0270	300	51	187	140	83	13	High	
95-4599	600	76	164	140	83	13	High	
95-4155	150	51	108	140	83	13	High	with rotated handles
95-0276	150	51	108	140	83	13	High	with short dip tube, cut to 1 inch from top of bubbler
95-4157	200	51	150	140	83	13	High	with rotated handles
95-0280	300	51	187	140	83	13	High	with rotated handles
95-4295	300	51	187	140	83	13	High	with rotated handles, no dip tube
95-4610	600	76	164	127	83	13	High	with rotated handles, no dip tube , stems same height

Chemical Vapor Deposition / Atomic Layer Deposition (CVD/ALD) Equipment

STAINLESS STEEL BUBBLERS: Vertical, Electropolished with fill-port

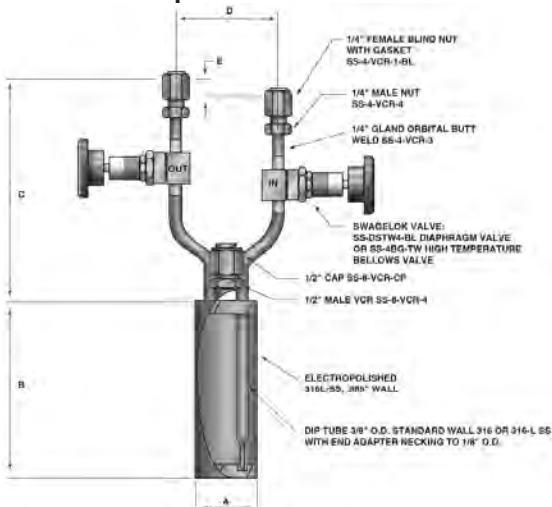

Stainless Steel Bubblers, vertical, electropolished with fill-port, PCTFE valve stem tip (121°C)								
Catalog #	Vol. (mL)	A mm	B mm	C mm	D mm	E mm	Temp. Valve	Special Configuration
96-4151	150	51	108	140	83	13	Standard	
96-4290	300	51	187	140	83	13	Standard	
96-4598	600	76	163	140	83	13	Standard	
96-4998	1000	76	254	140	83	13	Standard	
96-5002	1000	102	165	140	83	13	Standard	
96-5003	1400	102	203	140	83	13	Standard	
96-5001	1800	102	254	140	83	13	Standard	
96-5011	2750	152	188	140	83	13	Standard	
96-4149	150	51	108	140	83	13	Standard	with short dip tube, cut 5cm from top of bubbler
96-4153	150	51	108	140	83	13	Standard	with rotated handles

Stainless Steel Bubblers, vertical, electropolished with fill-port, high temperature valves (315°C)								
Catalog #	Vol. (mL)	A mm	B mm	C mm	D mm	E mm	Temp. Valve	Special Configuration
98-0271	150	51	108	140	83	13	High	
98-0270	300	51	187	140	83	13	High	
96-4599	600	76	163	140	83	13	High	
96-4996	1000	76	254	140	83	13	High	
98-0276	150	51	108	140	83	13	High	with short dip tube, cut to 1 inch from top of bubbler
98-0280	300	51	187	140	83	13	High	with rotated handles
96-4295	300	51	187	140	83	13	High	with rotated handles, no dip tube
96-4610	600	76	163	140	83	13	High	with rotated handles, no dip tube , stems same height

Chemical Vapor Deposition / Atomic Layer Deposition (CVD/ALD) Equipment

STAINLESS STEEL BUBBLERS:

Horizontal, Electropolished with fill-port, DOT4B, UN Stamped

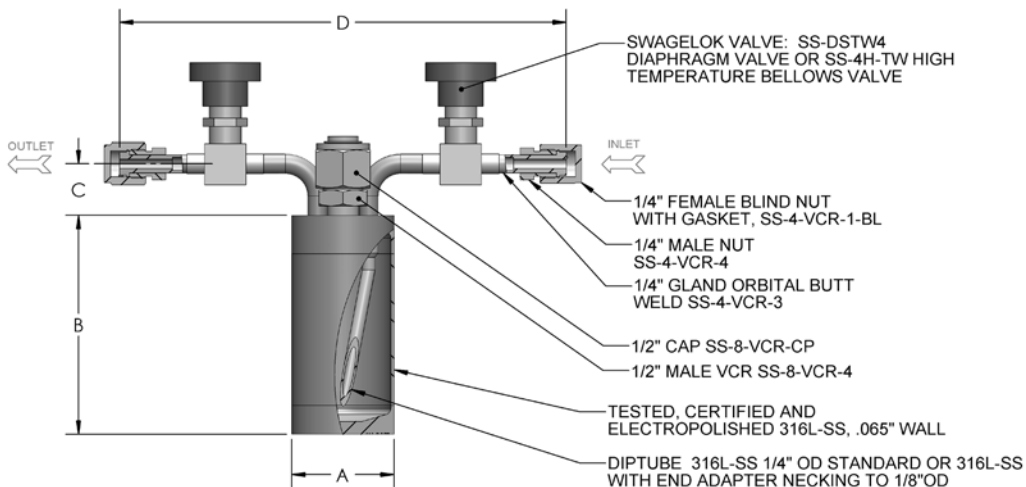

Stainless Steel Bubblers, horizontal, electropolished with fill-port, PCTFE valve stem tip (121°C) DOT 4B, UN stamped							
Catalog #	Vol. (mL)	A mm	B mm	C mm	D mm	Temp. Valve	Special Configuration
95-5151	150	51	108	24	222	Standard	
95-5298	300	51	187	24	222	Standard	
95-5599	600	76	164	24	222	Standard	
95-5998	1000	76	254	24	222	Standard	
95-5004	2000	152	152	24	222	Standard	
95-0273	150	51	108	24	222	Standard	with reversed handles

Stainless Steel Bubblers, horizontal, electropolished with fill-port, high temperature valves (315°C) DOT 4B, UN stamped							
Catalog #	Vol. (mL)	A mm	B mm	C mm	D mm	Temp. Valve	Special Configuration
95-0272	150	51	108	24	222	High	
95-5006	300	51	187	24	222	High	
95-5007	600	76	164	24	222	High	
95-5008	1000	76	254	24	222	High	

Chemical Vapor Deposition / Atomic Layer Deposition (CVD/ALD) Equipment

STAINLESS STEEL BUBBLERS:

Horizontal, Electropolished with fill-port

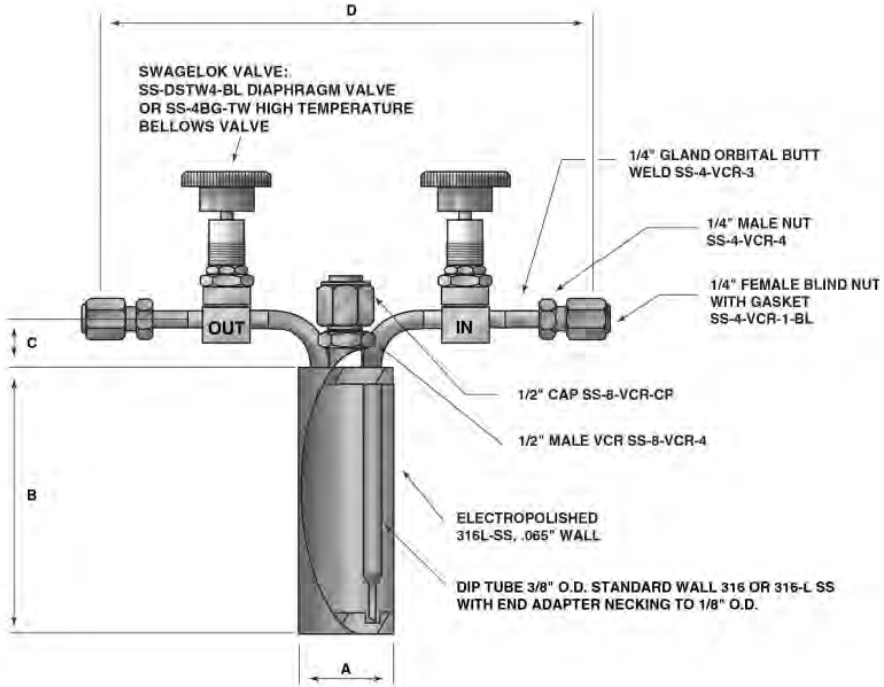

Stainless Steel Bubblers, horizontal, electropolished with fill-port, PCTFE valve stem tip (121°C)							
Catalog #	Vol. (mL)	A mm	B mm	C mm	D mm	Temp. Valve	Special Configuration
96-5151	150	51	108	24	222	Standard	
96-5298	300	51	187	24	222	Standard	
96-5599	600	76	163	24	222	Standard	
96-5998	1000	76	254	24	222	Standard	
96-5004	1800	102	254	24	222	Standard	
98-0273	150	51	108	24	222	Standard	with reversed handles
98-0275	150	51	108	24	222	Standard	with rotated handles

Stainless Steel Bubblers, horizontal, electropolished with fill-port, high temperature valves (315°C)							
Catalog #	Vol. (mL)	A mm	B mm	C mm	D mm	Temp. Valve	Special Configuration
98-0272	150	51	108	24	222	High	
96-5006	300	51	187	24	222	High	
96-5007	600	76	163	24	222	High	
96-5008	1000	76	254	24	222	High	

Suba-Seal®

Turn-over type vaccine closures for working with air-sensitive materials. These have a turnover flange molded to grip the outside of the container neck, thus promoting a double seal in conjunction with the annular serrations on the hollow plug. The annular serrations depress themselves against the inside wall of the bottle or flask neck making each serration a suction sealing point. The advantages of Suba-Seal® over ordinary septa are:

- Larger fitting surface
- Serrated area holds pressure better
- More solvent resistant
- The membrane on top is thick and self-sealing, permitting a large number of syringe piercings

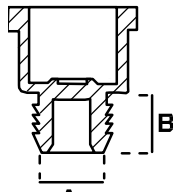

Catalog #	Description	Fits neck i.d. (mm)	Dimensions		# of Pieces
			A	B	
96-1000	Suba Seal #17	11.0	11.16	8.2	50
96-1500	Suba Seal #21	12.5	13.3	9.6	50
96-1900	Suba Seal #25 ^a	14.0	14.1	12.5	50
96-2000	Suba Seal #29	16	16.7	14.6	50
96-3000	Suba Seal #33 ^b	17.5	18.0	12.7	50
96-3500	Suba Seal #37 ^c	19.0	20.4	15.7	50
96-3800	Suba Seal #45 ^d	22.0	23.0	20.4	50
96-4000	Suba Seal #49	24.0	25.2	20.7	50
96-4500	Suba Seal #57 ^e	27.0	28.3	20.5	50

a - fits female 14/20 joint; b - fits Sure/Seal™ bottles; c - fits female 19/22 joint; d - fits female 24/40 joint; e - fits female 29-42 joint



Enzymatic Flow Reactor

Cat #	Description
96-0900	Enzymatic Flow Reactor (2.5 inch tube x 0.25 inch I.D.)

The EFR is a 2.5 inch long, 0.25 inch i.d. tube that is packed with stainless steel mesh coated with a total of approximately 50mg of silica nanosprings.

The surfaces of these nanosprings are functionalized with free sulfhydryl groups at the end of a three carbon chain that can react with an appropriately activated enzyme.

Trademarks and Registered Trademarks:

Alcalase®	Registered trademark of Novozymes.	Noblyst®	Registered trademark of Evonik Degussa AG.
AUROlite™	Trademark of AuTEK.	Novocor®	Registered trademark of Novozymes.
BRIDP®	Registered trademark of Takasago International Corp.	Novozym®	Registered trademark of Novozymes.
Brij®	Registered trademark of ICI America, Inc.	Novozymes®	Registered trademark of Novozymes.
CALSELECT®	Registered trademark of BASF.	OXONE®	Registered trademark of The Chemours Company, FC, LLC.
CANDot®	Registered trademark of Center of Applied Nanotechnology (CAN).	Palatase®	Registered trademark of Novozymes.
Carulite®	Registered trademark of Carus Chemical Co., a division of Carus Corporation.	Particular®	Registered trademark of Particular GmbH.
cataCXium®	Registered trademark of Evonik Degussa AG.	Raney®	Registered trademark of W.R. Grace and Co.
catMETium®	Registered trademark of Evonik Degussa AG.	Resinase®	Registered trademark of Novozymes.
catASium®	Registered trademark of Evonik Degussa AG.	RUCY®	Registered trademark of Takasago International Corp.
CONTEKTIC™	Trademark of framergy.	Savinase®	Registered trademark of Novozymes.
Crophos®	Registered trademark of Hokko Chemical Industry Co., Ltd.	SEGHOS®	Registered trademark of Takasago International Corp.
CYPHOS® IL	Registered trademark of Cytec Technology Corp.	SelectFluor®	Registered trademark of Air Products & Chemicals, Inc.
Escat™	Trademark of BASF.	Suba-Seal®	Registered trademark of Sigma-Aldrich Co. LLC.
Esperase®	Registered trademark of Novozymes.	Sure/Seal™	Trademark of Sigma-Aldrich Co. LLC.
FerroTANE®	Registered trademark of ChiroTech Technology Limited.	Swagelok®	Registered trademark of Swagelok Company.
FibreCat™	Trademark of Johnson Matthey PLC Corp.	Teflon®	Registered trademark of The Chemours Company FC, LLC.
Garphos™	Trademark of Kanata Chemical Technologies, Inc.	Trifluoromethylator®	Registered trademark of CATALIX Inc..
Lifetech™	Trademark of Purolite.	TWEEN®20	Registered trademark of Croda Americas LLC.
Lipozyme®	Registered trademark of Novozymes.	ZnTAC24®	Registered trademark of Takasago International Corp.
Ru-MACHO®	Registered trademark of Takasago International Corp.		
Neutrased®	Registered trademark of Novozymes.		

Visit strem.com for the following:

- New Product Announcements
- Searchable Catalog
- Technical Notes
- Safety Data Sheets (SDS)
- Certificates of Analysis (CofA)
- Product Pricing and Availability

If you are unable to find a product you need, please contact us.

Custom synthesis services are available.

Highlighted New Products

Biocatalysts - see pages 13-22

Iridium Photocatalysts - see pages 86-93

MOFs and Ligands for MOF Synthesis - see pages 134-135

Nanomaterials, including Graphene Quantum Dots - see pages 138-169

CVD Bubblers & ALD Cylinders - see pages 612-616



Electropolished stainless steel bubblers



Strem offers a variety of kits



Visitors Welcome

We are happy to meet with our customers from all over the world. We are located less than a one hour drive north from Boston's Logan International Airport.

Directions

From Logan Airport take Rte 1A North to American Legion Highway (Rte 60). Rte 60 to Rte 1 North. At Danvers take Rte 95 North to exit 56 (Scotland Road). Right on Scotland Road for about 3 miles. At first traffic light take left onto Mulliken Way. Strem is the second building on the left.

Enlarged maps are available on our website.

About Our Cover

Cover art by Lisa Bohnwagner - selected pieces from her solo show "Elemental" - the periodic table of the elements created from 71 six inch square paintings.

Lisa explains, "After back surgery my world and what I could do became extremely limited. It caused me to think about what is truly elemental to life. Part of that, for me, is art. The elements and their various combinations are the building blocks of life

and enable us not only to live, but to live a creative life."

Lisa's paintings are collected world-wide. To purchase element paintings (individually or as a group) please visit her web site: www.lisabohnwagner.com or contact her directly: lisa@lisabohnwagner.com

The Strem Product Line

Biocatalysts & Organocatalysts
Electronic Grade Chemicals
Fullerenes
High Purity Inorganics & Alkali Metals
Ionic Liquids
Ligands & Chiral Ligands
Metal Acetates & Carbonates
Metal Alkoxides & beta-Diketonates
Metal Alkyls & Alkylamides
Metal Carbonyls & Derivatives
Metal Catalysts & Chiral Catalysts
Metal Foils, Wires, Powders & Elements
Metal Halides, Hydrides & Deuterides
Metal Oxides, Nitrates, Chalcogenides
Metal Scavengers

Metalloenes
Nanomaterials
Organofluorines
Organometallics
Organophosphines & Arsines
Porphines & Phthalocyanines
Precious Metal & Rare Earth Chemicals
Volatile Precursors for MOCVD, CVD & ALD

Custom Synthesis
GMP Facilities
FDA Inspected
Drug Master Files
Complete Documentation

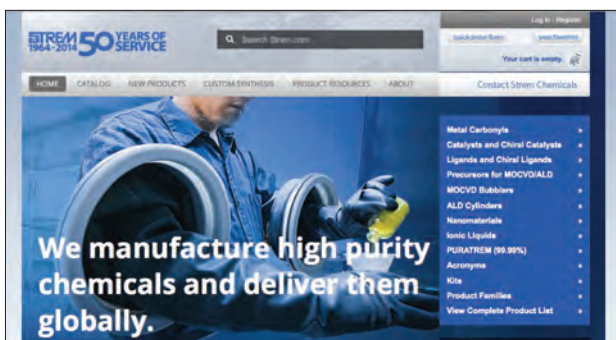

Visit strem.com

Strem Chemicals, Inc.

7 Mulliken Way
Dexter Industrial Park
Newburyport, MA 01950-4098
U.S.A.

Office Tel.: (978) 499-1600
Office Fax: (978) 465-3104
Toll-free Orders
Tel.: (800) 647-8736
Fax: (800) 517-8736
(U.S. & Canada only)

Email: info@strem.com
www.strem.com

Catalog Credits:

Cover paintings by Lisa Bohnwagner
Design by Renegade Studios
Cover Photo by John Raleigh
Photography by Greg Nikas

Strem Chemicals, Inc.

15, rue de l'Atome
Zone Industrielle
F-67800 BISCHHEIM (France)
Tel.: +33 (0) 3 88 62 52 60
Fax: +33 (0) 3 88 62 26 81
Email: info.europe@strem.com

Strem Chemicals, Inc.

Postfach 1215
D-77672 KEHL, Germany
Tel.: +49 (0) 7851 75879
Fax: +33 (0) 3 88 62 26 81
Email: info.europe@strem.com

Strem Chemicals UK Ltd.

An Independent Distributor
of Strem Chemicals products
Newton Hall, Town Street
Newton, Cambridge, CB22 7ZE, UK
Tel.: 0845 643 7263
Fax: 0845 643 7362
Email: enquiries@strem.co.uk

CATALOG NO. 26
2017-2019

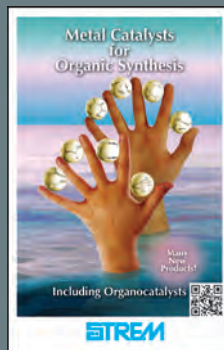
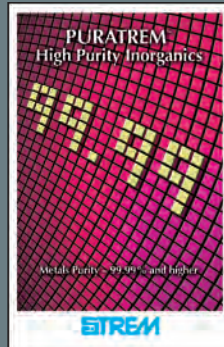
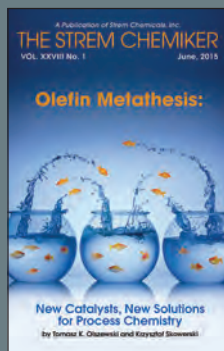
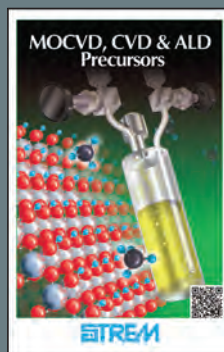

OTHER BOOKLETS
AVAILABLE