

# Corning Life Sciences Cell Culture Media and Reagents Product Selection Guide

CORNING





## Beginning-to-end Solutions from Corning

At Corning, we continuously strive towards improving efficiencies and developing new products and technologies to support researchers in their life science workflows.

The Corning product line, combined with Corning's disposable vessels, liquid handling products, and unique surfaces provides researchers with a comprehensive portfolio of products for life science research. Browse our portfolio at [www.corning.com/lifesciences](http://www.corning.com/lifesciences).

### Ordering Products Direct

Corning products are manufactured by Mediatech, Inc., a Corning subsidiary. Corning products are available directly from Corning's European Distribution Center. To place your order call Customer Service:

<b>France</b>	<b>United Kingdom</b>
t 0800 916 882	t 0800 376 8660
f 0800 918 636	f 0800 279 1117
<b>Germany</b>	<b>All Other European Countries</b>
t 0800 101 1153	t +31 20 659 60 51
f 0800 101 2427	f +31 20 659 76 73
<b>The Netherlands</b>	
t +31 20 655 79 28	
f +31 20 659 76 73	

Email: [CSEurope@corning.com](mailto:CSEurope@corning.com)

Online: [www.corning.com/lifesciences/media](http://www.corning.com/lifesciences/media)

### Phone/Fax Online Orders

For each order, customers should provide the Corning product number, product description, and desired quantity. You should also include your billing and shipping address and your account number.

To purchase Corning products online, please visit [www.corning.com/lifesciences/media](http://www.corning.com/lifesciences/media).

### Ordering Products Through our Distribution Partners

Customers can purchase Corning products from any one of our authorized distributors. See our complete listing of Corning distributors at:

[www.corning.com/lifesciences/media](http://www.corning.com/lifesciences/media)

Our distribution partners can offer our customers a variety of value added services from local inventory and service, to managed services and preferred programs. Please contact your distributor of choice for more details.

### Pricing

Prices shown on [www.corning.com/lifesciences/media](http://www.corning.com/lifesciences/media) reflect our current suggested U.S. list price. For customer-specific pricing information, please contact your sales representative or your authorized distributor.

### Technical Support

For technical support:

<b>France</b>	<b>United Kingdom</b>
t 0800 916 882	t 0800 376 8660
<b>Germany</b>	<b>All Other European Countries</b>
t 0800 101 1153	t +31 20 659 60 51
<b>The Netherlands</b>	
t +31 20 655 79 28	

Email: [ScientificSupportEMEA@corning.com](mailto:ScientificSupportEMEA@corning.com)

**CORNING** | **FALCON** **AXYGEN** **GOSSSELIN**



# Media, Sera, Reagents, and Flexible Packaging

- Classical Media ..... H5
- Buffered Salt Solutions ..... H13
- Serum-free/Specialty Media and Solutions ..... H17
- Islet Solutions ..... H21
- Human and Animal Sera ..... H23
- Cell Culture Reagents ..... H25
- Microbiology and Molecular Biology ..... H33
- High-quality Water ..... H37
- Flexible Packaging Systems ..... H39
- Formulations ..... H53

Media, Sera, Reagents,  
Flexible Bags

## Table of Contents

<b>Classical Media</b> .....	<b>H5</b>	<b>Cell Culture Reagents</b> .....	<b>H25</b>
DMEM (Dulbecco's Modification of Eagle's Medium).....	H6	Amino Acids and Vitamins.....	H26
DMEM/Ham's F-12 50/50 Mix.....	H7	Antibiotics and Antimycotics.....	H27
F-12K Nutrient Mixture (Kaighn's Modification).....	H7	Buffers.....	H29
Glasgow's MEM.....	H7	Enzymatic Cell Dissociation Agents.....	H29
Ham's F-10 Medium.....	H7	Non-enzymatic Cell Dissociation Agents.....	H30
Ham's F-12 Medium.....	H7	Growth Supplements.....	H30
Improved MEM (Richter's Modification).....	H8	Hybridoma Reagents.....	H31
IMDM (Iscove's Modification of DMEM).....	H8	Insect Reagents.....	H31
Leibovitz's L-15 (Modification).....	H8	Miscellaneous Reagents.....	H32
MCDB 131.....	H8		
McCoy's 5A (Iwaketa and Grace Modification).....	H8	<b>Microbiology and Molecular Biology</b> .....	<b>H33</b>
Medium 199 (Modification).....	H9	Miller's LB Broth.....	H34
MEM (Minimum Essential Medium).....	H9	S.O.C. Medium.....	H34
CMRL 1066.....	H9	Terrific Broth.....	H34
MEM (Minimum Essential Medium) Alpha Medium.....	H10	Ampicillin Sodium Salt.....	H34
RPMI 1640.....	H10	Carbenicillin Disodium Salt.....	H34
Grace's Insect Basal Medium (Vaughn Modification).....	H11	Kanamycin Sulfate.....	H34
Hink's TNM-FH Medium (Modification).....	H11	Neomycin Sulfate.....	H34
		Streptomycin Sulfate.....	H34
		Tetracycline Hydrochloride.....	H35
		X-Gal.....	H35
		IPTG (Isopropylthiogalactoside).....	H35
		MOPS Buffer.....	H35
<b>Buffered Salt Solutions</b> .....	<b>H13</b>	PBS (Phosphate Buffered Saline).....	H35
DPBS (Dulbecco's Phosphate Buffered Saline).....	H14	SSC Buffer.....	H35
PBS (Phosphate Buffered Saline).....	H14	SSPE Buffer.....	H35
HBSS (Hanks' Balanced Salt Solution).....	H14	TAE Buffer.....	H35
		TBE Buffer.....	H35
		TE Buffer.....	H36
		Tris Buffered Saline.....	H36
		Tris-HCl Buffers.....	H36
		EDTA.....	H36
		SDS (Sodium Dodecyl Sulfate).....	H36
		Sodium Acetate.....	H36
		Sodium Chloride.....	H36
		<b>High-quality Water</b> .....	<b>H37</b>
		Cell Culture Grade Water.....	H38
		Molecular Biology Grade Water.....	H38
		Reagent Grade Water.....	H38
		<b>Flexible Packaging Systems</b> .....	<b>H39</b>
		Collection Containers.....	H40
		Cell Expansion Bags.....	H42
		Cryopreservation Bags.....	H43
		Rocker Cell Culture Bags.....	H44
		Tubing Sets.....	H46
		Single-use Bags for Corning® HYPERStack® Vessels.....	H47
		Tank Liners.....	H48
		Film Types.....	H49
		<b>Formulations</b> .....	<b>H53</b>
<b>Serum-free/Specialty Media and Solutions</b> .....	<b>H17</b>		
SF Medium.....	H18		
PF Medium.....	H18		
Corning® transfectagro™ Reduced-serum Medium.....	H18		
LSM (Lymphocyte Separation Medium).....	H18		
TSB (Tryptic Soy Broth).....	H18		
Corning hybrigro™ SF Medium.....	H19		
Corning stemgro® hMSC Medium.....	H19		
Corning NutriStem® hPSC XF Medium.....	H19		
Corning insectagro® DS2.....	H19		
Corning insectagro Sf9.....	H19		
<b>Islet Solutions</b> .....	<b>H21</b>		
Islet Solutions and Reagents.....	H22		
Cell Separation and Gradient Solutions.....	H22		
Porcine Solutions.....	H22		
Preservation Solutions.....	H22		
<b>Human and Animal Sera</b> .....	<b>H23</b>		
Fetal Bovine Serum.....	H24		
Human AB Serum.....	H24		

## Classical Media

### Growth Promotion and Cytotoxicity

Corning® classical media products undergo a variety of tests to determine functionality and toxicity using growth-promotion analysis. Product performance is measured by harvest-to-plant ratios or fold increase according to predetermined specifications.

### Physiochemical Properties

Liquid and powder classical media products are tested to determine pH and osmolality. Classical media powders are also tested for residual moisture. The pH and osmolality tests are performed according to specific procedures in which all equipment is calibrated using standards traceable to the National Institute of Standards and Technology.

### Biological Tests

Quality release testing of Corning liquid classical media products assures low levels of endotoxin, mycoplasma, and an absence of contamination.

**Endotoxin:** Classical media products are tested for bacterial endotoxin using the Limulus Amoebocyte Lysate (LAL) chromogenic assay. For release, each lot of standard liquid classical media must have an endotoxin level of <0.25 EU/mL. Classical media powder products must have an endotoxin level of <0.25 EU/mL when reconstituted to formula weight with low endotoxin water.

**Sterility:** All Corning liquid classical media products are tested for sterility.

**Mycoplasma:** Liquid classical media products are tested for mycoplasma using a large-volume method.





### DMEM (Dulbecco's Modification of Eagle's Medium)

Contains	Powder																
	10-013	10-014	10-017	10-027	10-101	10-102	15-013	15-017	15-018	17-204	17-205	17-206	17-207	50-003	50-013	90-013	90-113
L-glutamine	■	■	■	■										■	■		
Sodium pyruvate	■	■			■		■		■	■	■	■		■			
Phenol red	■	■	■	■	■	■	■	■	■	■		■	■	■	■		
L-cystine/L-methionine	■	■	■	■	■	■	■	■	■		■	■	■	■	■	■	■
Phosphate	■	■	■	■			■	■	■	■	■		■	■	■	■	■
HEPES				■					■								
High glucose	■		■	■	■	■	■	■	■	■	■	■		■	■	■	
Sodium bicarbonate	■	■	■	■	■	■	■	■	■	■	■	■	■				
Corning® glutagro™					■	■											
Pyridoxine HCl														■	■	■	■

#### Liquid

Cat. No.	Description	Storage	Shelf Life	Size	Qty/Pk
10-013-CVR	[+] 4.5 g/L Glucose, L-glutamine, sodium pyruvate	2°C to 8°C	18 m	500 mL	6
10-013-CMR	[+] 4.5 g/L Glucose, L-glutamine, sodium pyruvate	2°C to 8°C	18 m	1L	6
10-013-LXR	[+] 4.5 g/L Glucose, L-glutamine, sodium pyruvate	2°C to 8°C	18 m	10L	1
10-013-LBR	[+] 4.5 g/L Glucose, L-glutamine, sodium pyruvate	2°C to 8°C	18 m	20L	1
10-014-CVR	[+] 1.0 g/L Glucose, sodium pyruvate, L-glutamine	2°C to 8°C	18 m	500 mL	6
10-014-CMR	[+] 1.0 g/L Glucose, sodium pyruvate, L-glutamine	2°C to 8°C	18 m	1L	6
10-017-CVR	[+] 4.5 g/L Glucose, L-glutamine; [-] sodium pyruvate	2°C to 8°C	18 m	500 mL	6
10-017-CMR	[+] 4.5 g/L Glucose, L-glutamine; [-] sodium pyruvate	2°C to 8°C	18 m	1L	6
10-027-CVR	[+] 25 mM HEPES, 4.5 g/L glucose, L-glutamine; [-] sodium pyruvate	2°C to 8°C	18 m	500 mL	6
10-101-CVR	[+] Corning glutagro™ supplement, 4.5 g/L glucose, sodium pyruvate, phenol red	2°C to 8°C	12 m	500 mL	6
10-102-CVR	[+] Corning glutagro supplement, 4.5 g/L glucose, phenol red; [-] sodium pyruvate	2°C to 8°C	12 m	500 mL	6
15-013-CVR	[+] 4.5 g/L Glucose, sodium pyruvate; [-] L-glutamine	2°C to 8°C	18 m	500 mL	6
15-013-CMR	[+] 4.5 g/L Glucose, sodium pyruvate; [-] L-glutamine	2°C to 8°C	18 m	1L	6
15-013-LXR	[+] 4.5 g/L Glucose, sodium pyruvate; [-] L-glutamine	2°C to 8°C	18 m	10L	1
15-013-LBR	[+] 4.5 g/L Glucose, sodium pyruvate; [-] L-glutamine	2°C to 8°C	18 m	20L	1
15-017-CVR	[+] 4.5 g/L Glucose; [-] L-glutamine, sodium pyruvate	2°C to 8°C	18 m	500 mL	6
15-017-CMR	[+] 4.5 g/L Glucose; [-] L-glutamine, sodium pyruvate	2°C to 8°C	18 m	1L	6
15-018-CVR	[+] 4.5 g/L Glucose, sodium pyruvate, 25 mM HEPES; [-] L-glutamine	2°C to 8°C	18 m	500 mL	6
15-018-CMR	[+] 4.5 g/L Glucose, sodium pyruvate, 25 mM HEPES; [-] L-glutamine	2°C to 8°C	18 m	1L	6
17-204-CIR	[+] 4.5 g/L Glucose, sodium pyruvate; [-] L-glutamine, L-methionine, L-cystine	2°C to 8°C	18 m	100 mL	6
17-205-CVR	[+] 4.5 g/L Glucose, sodium pyruvate; [-] L-glutamine, phenol red	2°C to 8°C	18 m	100 mL	6
17-206-CIR	[+] 4.5 g/L Glucose, sodium pyruvate; [-] L-glutamine, phosphate	2°C to 8°C	18 m	100 mL	6
17-207-CVR	[-] Glucose, L-glutamine, sodium pyruvate	2°C to 8°C	18 m	500 mL	6

#### Powder

Cat. No.	Description	Storage	Shelf Life	Size*	Qty/Pk
50-003-PBR	[+] 4.5 g/L Glucose, L-glutamine, sodium pyruvate; [-] sodium bicarbonate	2°C to 8°C	36 m	10L	1
50-003-PCR	[+] 4.5 g/L Glucose, L-glutamine, sodium pyruvate; [-] sodium bicarbonate	2°C to 8°C	36 m	50L	1
50-013-PBR	[+] 4.5 g/L Glucose, L-glutamine; [-] sodium pyruvate, sodium bicarbonate	2°C to 8°C	36 m	10L	1
50-013-PCR	[+] 4.5 g/L Glucose, L-glutamine; [-] sodium pyruvate, sodium bicarbonate	2°C to 8°C	36 m	50L	1
90-013-PBR	[+] 4.5 g/L Glucose; [-] sodium bicarbonate, L-glutamine, sodium pyruvate, phenol red	2°C to 8°C	36 m	10L	1
90-113-PBR	[-] Sodium bicarbonate, glucose, L-glutamine, sodium pyruvate, phenol red	2°C to 8°C	36 m	10L	1

\*Powder media volume indicated is the reconstituted volume.

### DMEM/Ham's F-12 50/50 Mix

Contains	10-090	10-092	10-103	15-090	16-405	Powder	
						90-090	90-091
L-glutamine	■	■			■		
Sodium pyruvate	■	■	■	■	■	■	■
Phenol red	■	■	■	■			■
HEPES		■	■				
Sodium bicarbonate	■	■	■	■	■		
Corning® glutagro™			■				

#### Liquid ♦

Cat. No.	Description	Storage	Shelf Life	Size	Qty/Pk
10-090-CVR	[+] L-glutamine	2°C to 8°C	12 m	500 mL	6
10-090-CMR	[+] L-glutamine	2°C to 8°C	12 m	1L	6
10-092-CVR	[+] L-glutamine, 15 mM HEPES	2°C to 8°C	12 m	500 mL	6
10-092-CMR	[+] L-glutamine, 15 mM HEPES	2°C to 8°C	12 m	1L	6
16-405-CVR	[+] L-glutamine; [-] phenol red	2°C to 8°C	12 m	500 mL	6
15-090-CVR	[+] L-glutamine	2°C to 8°C	18 m	500 mL	6
15-090-CMR	[-] L-glutamine	2°C to 8°C	18 m	1L	6
10-103-CVR	[+] Corning glutagro™	2°C to 8°C	36 m	500 mL	6

#### Powder ⚡

Cat. No.	Description	Storage	Shelf Life	Size*	Qty/Pk
90-090-PBR	[-] Sodium bicarbonate, L-glutamine, phenol red	2°C to 8°C	36 m	10L	6
90-091-PBR	[+] L-glutamine	2°C to 8°C	36 m	10L	6

### F-12K Nutrient Mixture (Kaighn's Modification), 1x

#### Liquid ♦

Cat. No.	Description	Storage	Shelf Life	Size	Qty/Pk
10-025-CVR	[+] L-glutamine	2°C to 8°C	12 m	500 mL	6

### Glasgow's MEM

#### Powder ⚡

Cat. No.	Description	Storage	Shelf Life	Size*	Qty/Pk
50-004-PBR	[+] L-glutamine; [-] sodium bicarbonate, tryptose phosphate broth	2°C to 8°C	36 m	10L	1

### Ham's F-10 Medium

#### Liquid ♦

Cat. No.	Description	Storage	Shelf Life	Size	Qty/Pk
10-070-CVR	[+] L-glutamine	2°C to 8°C	12 m	500 mL	6

### Ham's F-12 Medium

#### Liquid ♦

Cat. No.	Description	Storage	Shelf Life	Size	Qty/Pk
10-080-CVR	[+] L-glutamine	2°C to 8°C	12 m	500 mL	6
10-080-CMR	[+] L-glutamine	2°C to 8°C	12 m	1L	6

#### Powder ⚡

Cat. No.	Description	Storage	Shelf Life	Size*	Qty/Pk
50-040-PBR	[+] L-glutamine; [-] sodium bicarbonate	2°C to 8°C	36 m	10L	1

\*Powder media volume indicated is the reconstituted volume

### Improved MEM (Richter's Modification), 1x

#### Liquid

Cat. No.	Description	Storage	Shelf Life	Size	Qty/Pk
10-024-CVR	[+] L-glutamine	2°C to 8°C	12 m	500 mL	6
10-026-CVR	[+] L-glutamine; [-] phenol red	2°C to 8°C	12 m	500 mL	6

### IMDM (Iscove's Modification of DMEM), 1x

Contains	10-016	15-016
L-glutamine	■	
Sodium pyruvate	■	■
Phenol red	■	■
Pyridoxine HCl	■	■
Sodium bicarbonate	■	■

#### Liquid

Cat. No.	Description	Storage	Shelf Life	Size	Qty/Pk
10-016-CVR	[+] L-glutamine and 25 mM HEPES; [-] α-thioglycerol, β-mercaptoethanol	2°C to 8°C	12 m	500 mL	6
10-016-CMR	[+] L-glutamine and 25 mM HEPES; [-] α-thioglycerol, β-mercaptoethanol	2°C to 8°C	12 m	1L	6
15-016-CVR	[+] 25 mM HEPES; [-] α-thioglycerol, β-mercaptoethanol, L-glutamine	2°C to 8°C	12 m	500 mL	6

#### Powder

Cat. No.	Description	Storage	Shelf Life	Size*	Qty/Pk
50-016-PBR	[+] 25 mM HEPES; [-] α-thioglycerol, β-mercaptoethanol, sodium bicarbonate	2°C to 8°C	36 m	10L	1

### Leibovitz's L-15 (Modification), 1x

#### Liquid

Cat. No.	Description	Storage	Shelf Life	Size	Qty/Pk
10-045-CVR	[+] L-glutamine	2°C to 8°C	12 m	500 mL	6

### MCDB 131, 1x

#### Liquid

Cat. No.	Description	Storage	Shelf Life	Size	Qty/Pk
15-100-CVR	[-] L-glutamine	2°C to 8°C	12 m	500 mL	6

### McCoy's 5A (Iwaketa and Grace Modification), 1x

Contains	10-050	10-051
L-glutamine	■	■
Phenol red	■	■
HEPES		■
Sodium bicarbonate	■	■

#### Liquid

Cat. No.	Description	Storage	Shelf Life	Size	Qty/Pk
10-050-CVR	[+] L-glutamine	2°C to 8°C	18 m	500 mL	6
10-051-CIR	[+] L-glutamine, 25 mM HEPES	2°C to 8°C	18 m	100 mL	6



### Medium 199 (Modification)

Contains	Powder		
	10-060-CV	50-050	90-050
L-glutamine	■	■	
Phenol red		■	
Earle's salts	■	■	■
Hank's salts			
Sodium bicarbonate			

#### Liquid ♦

Cat. No.	Description	Storage	Shelf Life	Size	Qty/Pk
10-060-CVR	[+] Earle's salts, L-glutamine	2°C to 8°C	18 m	500 mL	6

#### Powder ⚡

Cat. No.	Description	Storage	Shelf Life	Size*	Qty/Pk
50-050-PBR	[+] Earle's salts, L-glutamine; [-] sodium bicarbonate	2°C to 8°C	36 m	10L	1
90-050-PBR	[+] Earle's salts; [-] sodium bicarbonate, L-glutamine, phenol red	2°C to 8°C	36 m	10L	1

### MEM (Minimum Essential Medium)

Contains	Powder									
	10-009	10-010	15-010	15-015	17-305	50-010	50-011	50-019	51-010	90-009
L-glutamine	■	■				■		■		
Phenol red		■	■	■		■	■		■	
L-Methionine		■	■	■	■					
Calcium and magnesium		■	■		■					
Sodium bicarbonate	■	■	■	■	■					
Non-essential amino acids	■									
Sodium pyruvate	■									
Earle's salts						■	■		■	■
Hank's salts								■		

#### Liquid ♦

Cat. No.	Description	Storage	Shelf Life	Size	Qty/Pk
10-009-CVR	[+] Sodium bicarbonate, NEAA, L-glutamine, sodium pyruvate	2°C to 8°C	18 m	500 mL	6
10-010-CVR	[+] Earle's salts, L-glutamine	2°C to 8°C	18 m	500 mL	6
10-010-CMR	[+] Earle's salts, L-glutamine	2°C to 8°C	18 m	1L	6
15-010-CVR	[+] Earle's salts; [-] L-glutamine	2°C to 8°C	18 m	500 mL	6
15-010-CMR	[+] Earle's salts; [-] L-glutamine	2°C to 8°C	18 m	1L	6
15-015-CVR	[-] L-glutamine, calcium, magnesium	2°C to 8°C	18 m	500 mL	6
17-305-CVR	[+] Earle's salts; [-] L-glutamine, phenol red	2°C to 8°C	18 m	500 mL	6

#### Powder ⚡

Cat. No.	Description	Storage	Shelf Life	Size*	Qty/Pk
50-010-PBR	[+] Earle's salts, L-glutamine; [-] sodium bicarbonate	2°C to 8°C	36 m	10L	1
50-010-PCR	[+] Earle's salts, L-glutamine; [-] sodium bicarbonate	2°C to 8°C	36 m	50L	1
50-011-PBR	[+] Earle's salts, L-glutamine, NEAA; [-] sodium bicarbonate	2°C to 8°C	36 m	10L	1
50-011-PCR	[+] Earle's salts, L-glutamine, NEAA; [-] sodium bicarbonate	2°C to 8°C	36 m	50L	1
51-010-PCR	[+] Earle's salts; [-] sodium bicarbonate, L-glutamine	2°C to 8°C	36 m	50L	1
50-019-PBR	[+] Hank's salts, L-glutamine; [-] sodium bicarbonate	2°C to 8°C	36 m	10L	1
90-009-PBR	[+] Earle's salts; [-] L-glutamine, phenol red, sodium bicarbonate	2°C to 8°C	36 m	10L	1

\*Powder media volume indicated is the reconstituted volume

### CMRL 1066

#### Liquid ♦

Cat. No.	Description	Storage	Shelf Life	Size	Qty/Pk
15-110-CVR	[-] L-glutamine	2°C to 8°C	36 m	500 mL	6

\*Powder media volume indicated is the reconstituted volume

### MEM (Minimum Essential Medium) Alpha Medium

Contains			Powder
	10-022	15-012	50-012
L-glutamine	■		■
Phenol red	■	■	■
Nucleosides	■		
Sodium pyruvate	■	■	■
Sodium bicarbonate	■	■	

#### Liquid ♦

Cat. No.	Description	Storage	Shelf Life	Size	Qty/Pk
10-022-CVR	[+] Earle's salts, ribonucleosides, deoxyribonucleosides, L-glutamine	2°C to 8°C	12 m	500 mL	6
15-012-CVR	[+] Earle's salts; [-] ribonucleosides, deoxyribonucleosides, L-glutamine	2°C to 8°C	18 m	500 mL	6

#### Powder ⚡

Cat. No.	Description	Storage	Shelf Life	Size*	Qty/Pk
50-012-PCR	[+] Earle's salts, L-glutamine ; [-] ribonucleosides, deoxyribonucleosides, sodium bicarbonate	2°C to 8°C	36 m	50L	1

### RPMI 1640

Contains									Powder	
	10-040	10-041	10-043	10-104	15-040	15-041	17-104	17-105	50-020	90-022
L-glutamine	■	■	■						■	
Phenol red	■	■	■	■	■	■	■		■	
HEPES		■				■				
L-cystine/L-methionine	■	■	■	■	■	■		■	■	
Sodium bicarbonate	■	■	■	■	■	■	■	■		
Corning® glutagro™				■						

#### Liquid ♦

Cat. No.	Description	Storage	Shelf Life	Size	Qty/Pk
10-040-CVR	[+] L-glutamine	2°C to 8°C	18 m	500 mL	6
10-040-CMR	[+] L-glutamine	2°C to 8°C	18 m	1L	6
10-040-LXR	[+] L-glutamine	2°C to 8°C	18 m	10L	6
10-040-LBR	[+] L-glutamine	2°C to 8°C	18 m	20L	6
10-041-CVR	[+] L-glutamine and 25 mM HEPES	2°C to 8°C	18 m	500 mL	6
10-041-CMR	[+] L-glutamine and 25 mM HEPES	2°C to 8°C	18 m	1L	6
10-043-CVR	[+] L-glutamine; [-] glucose	2°C to 8°C	18 m	500 mL	6
10-104-CVR	[+] Corning glutagro™, phenol red	2°C to 8°C	18 m	500 mL	6
15-040-CVR	[-] L-glutamine	2°C to 8°C	18 m	500 mL	6
15-040-CMR	[-] L-glutamine	2°C to 8°C	18 m	1L	6
15-040-LBR	[-] L-glutamine	2°C to 8°C	18 m	20L	1
15-041-CVR	[+] 25 mM HEPES; [-] L-glutamine	2°C to 8°C	18 m	500 mL	6
17-104-CIR	[-] L-glutamine, L-methionine, L-cystine	2°C to 8°C	18 m	100 mL	6
17-105-CVR	[-] L-glutamine, phenol red	2°C to 8°C	18 m	500 mL	6

#### Powder ⚡

Cat. No.	Description	Storage	Shelf Life	Size*	Qty/Pk
50-020-PBR	[+] L-glutamine; [-] sodium bicarbonate	2°C to 8°C	36 m	10L	1
50-020-PCR	[+] L-glutamine; [-] sodium bicarbonate	2°C to 8°C	36 m	50L	1
90-022-PBR	[-] L-glutamine, phenol red, sodium bicarbonate	2°C to 8°C	36 m	10L	1

\*Powder media volume indicated is the reconstituted volume.

## INSECT MEDIA

### Grace's Insect Basal Medium (Vaughn Modification)

Liquid 

Cat. No.	Description	Storage	Shelf Life	Size	Qty/Pk
13-200-CVR	[+] L-glutamine; [-] insect hemolymph	2 to 8°C	12 m	500 mL	6

### Hink's TNM-FH Medium (Modification) (Supplemented Grace's Medium)

Liquid 

Cat. No.	Description	Storage	Shelf Life	Size	Qty/Pk
13-100-CVR	[+] L-glutamine, lactalbumin hydrolysate, UF yeast extract; [-] insect hemolymph	2 to 8°C	12 m	500 mL	6



## Buffered Salt Solutions

Buffered salt solutions are made to a physiological pH and salt concentration. They are used alone or in combination with other agents for washing tissues and cells. Buffered salt solutions most commonly include sodium, potassium, calcium, magnesium, and chloride. They provide the cells with water and inorganic ions, while maintaining a physiological pH and osmotic pressure.

Although there have been many modifications to the original formulas to produce fully defined media, salt solutions still play an important role in tissue culture. A salt solution's basic functions, to maintain the pH and osmotic balance in the medium and to provide the cells with water and essential inorganic ions, are as valuable today as when it was first developed a century ago.



## DPBS (Dulbecco's Phosphate Buffered Saline)

Contains	20-030	20-031	21-030	21-031	Powder
					55-031
Calcium	■		■		
Magnesium	■		■		
Potassium chloride	■	■	■	■	■

### Liquid

Cat. No.	Description	Storage	Shelf Life	Size	Qty/Pk
20-030-CVR	[+] Calcium and magnesium, 10x	2°C to 30°C	18 m	500 mL	6
20-031-CVR	[-] Calcium and magnesium, 10x	2°C to 30°C	18 m	500 mL	6
21-030-CVR	[+] Calcium and magnesium, 1x	2°C to 30°C	36 m	500 mL	6
21-030-CMR	[+] Calcium and magnesium, 1x	2°C to 30°C	36 m	1L	6
21-031-CVR	[-] Calcium and magnesium, 1x	2°C to 30°C	36 m	500 mL	6
21-031-CMR	[-] Calcium and magnesium, 1x	2°C to 30°C	36 m	1L	6
21-031-LXR	[-] Calcium and magnesium, 1x	2°C to 30°C	36 m	10L	1
21-031-LBR	[-] Calcium and magnesium, 1x	2°C to 8°C	36 m	20L	1

### Powder

Cat. No.	Description	Storage	Shelf Life	Size*	Qty/Pk
55-031-PBR	[-] Calcium and magnesium	2°C to 8°C	36 m	10L	1
55-031-PCR	[-] Calcium and magnesium	2°C to 8°C	36 m	50L	1

\*Powder media volume indicated is the reconstituted volume

## PBS (Phosphate Buffered Saline)

### Liquid

Cat. No.	Description	Storage	Shelf Life	Size	Qty/Pk
21-040-CVR	[-] Calcium and magnesium, pH 7.4 ± 0.1, 1x	2°C to 30°C	24 m	500 mL	6
21-040-CMR	[-] Calcium and magnesium, pH 7.4 ± 0.1, 1x	2°C to 30°C	24 m	1L	6
21-040-CMRX12	[-] Calcium and magnesium, pH 7.4 ± 0.1, 1x	2°C to 30°C	24 m	1L	12



### HBSS (Hank's Balanced Salt Solution)

Contains	20-021	20-023	21-020	21-021	21-022	21-023	Powder
							55-022
Calcium		■	■			■	
Magnesium		■	■			■	
Phenol red	■		■	■			
Sodium bicarbonate			■	■	■	■	

#### Liquid ♦

Cat. No.	Description	Storage	Shelf Life	Size	Qty/Pk
20-021-CVR	[-] Sodium bicarbonate, calcium, magnesium	2°C to 30°C	36 m	500 mL	6
20-023-CVR	[+] Calcium, magnesium; [-] phenol red, sodium bicarbonate	2°C to 30°C	36 m	500 mL	6
21-020-CVR	[+] Calcium, magnesium, 1x	2°C to 30°C	36 m	500 mL	6
21-020-CMR	[+] Calcium, magnesium, 1x	2°C to 30°C	36 m	1L	6
21-021-CVR	[-] Calcium, magnesium, 1x	2°C to 30°C	36 m	500 mL	6
21-021-CMR	[-] Calcium, magnesium, 1x	2°C to 30°C	36 m	1L	6
21-022-CVR	[-] Calcium, magnesium, phenol red, 1x	2°C to 30°C	36 m	500 mL	6
21-022-CMR	[-] Calcium, magnesium, phenol red, 1x	2°C to 30°C	36 m	1L	6
21-023-CVR	[+] Calcium, magnesium; [-] phenol red, 1x	2°C to 30°C	36 m	500 mL	6
21-023-CMR	[+] Calcium, magnesium; [-] phenol red, 1x	2°C to 30°C	36 m	1L	6

#### Powder ⚗

Cat. No.	Description	Storage	Shelf Life	Size*	Qty/Pk
55-022-PBR	[-] Sodium bicarbonate, calcium, magnesium	2°C to 8°C	36 m	10L	1

\*Powder media volume indicated is the reconstituted volume



## Serum-free/Specialty Media and Solutions

Serum has been extensively used as a supplement to chemically defined media for mammalian cell culture due to its beneficial attributes. As a complex supplement it contains proteins, growth factors, hormones, amino acids, sugars, trypsin inhibitors, and lipids which support vigorous *in vitro* growth of a large number of cell types.

However, there are many negative aspects associated with the use of serum such as cost, time-consuming sampling, lot-to-lot variability, presence of adventitious agents, and availability. These aspects are particularly troublesome with the use of serum in the production of recombinant proteins, viral vaccines, cellular therapies, and monoclonal antibodies. In such cases, extensive downstream purification is required to remove serum-derived protein from the medium and to assure the absence of adventitious pathogens.

To minimize those problems associated with the use of serum, several defined, serum-free media have been developed and commercialized. Serum-free growth media pose numerous advantages over the use of serum, including lot-to-lot consistency, reduced foaming, the reduction of exogenous agents, simpler downstream processing, and high cell yield support.



### SF Medium

SF Medium is based on a proprietary classical media formulation. This medium contains a mixture of select trace elements and high molecular weight carbohydrates, extra vitamins, animal-free protein, and a small amount of high quality bovine serum albumin (1.0 g/L). SF Medium supports superior growth and viability over long-term passages in hybridomas, as well as suspension and adherent cell cultures. This formulation contains L-glutamine.

#### Liquid

Cat. No.	Description	Storage	Shelf Life	Size	Qty/Pk
40-101-CV	[+] L-glutamine, 1 g/L BSA	2°C to 8°C	12 m	500 mL	6
40-102-CV	[+] L-glutamine, 1 g/L BSA; [-] phenol red	2°C to 8°C	12 m	500 mL	6

### PF Medium

Optimized for the cultivation of Chinese Hamster Ovary (CHO) cells, along with many derivatives of this parent line, PF Medium is a proprietary serum-free and protein-free growth medium that does not contain any hormones or growth factors. This medium supports superior growth and viability over long-term passages in both adherent and suspension culture, and is formulated without L-glutamine.

#### Liquid

Cat. No.	Description	Storage	Shelf Life	Size	Qty/Pk
40-200-CV	[-] L-glutamine	2°C to 8°C	12 m	500 mL	6

### Corning® transfectagro™ Reduced-serum Medium

transfectagro reduced-serum medium is designed to maximize the growth of a variety of cell types under reduced-serum conditions, generally allowing for at least a 50% reduction in serum use with minimal adaptation. A chemically defined, reduced-serum formulation, transfectagro also improves transient transfection efficiency in a variety of cell types.

#### Liquid

Cat. No.	Description	Storage	Shelf Life	Size	Qty/Pk
40-300-CVR	[+] Lower levels of calcium and phenol red, HEPES	2°C to 8°C	12 m	500 mL	6

### LSM (Lymphocyte Separation Medium)

Lymphocyte Separation Medium was originally designed for the *in vitro* isolation of lymphocytes from diluted whole blood. It is a sterile filtered, iso-osmotic polysucrose and diatrizoate solution with low viscosity and a density of 1.077-1.080 g/cm<sup>3</sup> at 20°C.

#### Liquid

Cat. No.	Description	Storage	Shelf Life	Size	Qty/Pk
25-072-CI	LSM, Density - 1.077 - 1.080 g/cm <sup>3</sup> at 20°C	15°C to 30°C	18 m	100 mL	1
25-072-CV	LSM, Density - 1.077 - 1.080 g/cm <sup>3</sup> at 20°C	15°C to 30°C	18 m	500 mL	1

### TSB (Tryptic Soy Broth)

Tryptic Soy Broth is a sterile-filtered, ready-to-use solution for use in sterility testing and validation in the manufacture of a liquid product. The use of this medium in place of the product intended for production allows for the assessment of the capability of an aseptic manufacturing process. Due to the rich nutrient base, TSB may be used in the cultivation of fastidious micro-organisms. This growth medium has animal-free components, making it ideal for testing the sterility of animal-free biopharmaceutical processes.

#### Liquid

Cat. No.	Description	Storage	Shelf Life	Size	Qty/Pk
46-060-CI	Tryptic soy broth, animal-free	15°C to 30°C	12 m	100 mL	1
46-060-CM	Tryptic soy broth, animal-free	15°C to 30°C	12 m	1L	1
46-060-LB	Tryptic soy broth, animal-free	15°C to 30°C	12 m	20L	1

#### Powder

Cat. No.	Description	Storage	Shelf Life	Size	Qty/Pk
61-411-RO	Tryptic soy broth, animal-free	15°C to 30°C	12 m	500 g	1

### Corning® hybrigro™ SF Medium

Specifically developed for serum-free growth and antibody production with a variety of hybridoma cell lines, hybrigro SF medium is a complete, animal-free component, defined medium.

**Liquid** 📌

Cat. No.	Description	Storage	Shelf Life	Size	Qty/Pk
40-215-CVR	hybrigro SF medium with Corning glutagro™ supplement	2°C to 8°C	12 m	500 mL	6

### Corning stemgro® hMSC Medium

Serum-free stemgro hMSC medium has been designed for the maximum expansion of human mesenchymal stem cells (hMSCs) derived from bone marrow, cord blood, or adipose tissue. The stemgro hMSC medium is defined as its components are either chemically synthesized or recombinantly produced and purified. The stemgro hMSC medium offers the convenience of no vessel coating with biological materials if used with Corning CellBIND® or Primaria™ surface cell culture vessels, saving the cost of coating materials and time.

**Liquid** 📌

Cat. No.	Description	Storage	Shelf Life	Size	Qty/Pk
40-410-KIT	stemgro hMSC medium and supplement	-20°C to 8°C	12 m	KIT	1

### Corning NutriStem® hPSC XF Medium

Corning NutriStem hPSC XF medium is a defined, xeno-free, serum-free medium designed to support the growth and expansion of human induced pluripotent stem (hiPS) and human embryonic stem (hES) cells in a feeder-free environment.

**Liquid** 📌

Cat. No.	Description	Storage	Shelf Life	Size	Qty/Pk
40-05-100-1A	Nutristem hPSC XF Medium (+) HAS	-25 to -10°C	18 m	500 mL	1
40-05-100-1B	Nutristem hPSC XF Medium (+) HAS	-25 to -10°C	18 m	100 mL	1

## INSECT MEDIA

### Corning insectagro® DS2 Serum-free/Protein-free Medium, 1x

insectagro DS2 serum-free/protein-free medium was developed for the growth and maintenance of Drosophila Schneider 2 (DS2) cells to be used in heterologous protein expression. At the optimal temperature range (22°C to 24°C), DS2 cells grow as a loose monolayer and are readily adaptable to growth in suspension. Under these conditions, the cells require minimal adaptation to serum-free culture.

**Liquid** 📌

Cat. No.	Description	Storage	Shelf Life	Size	Qty/Pk
13-402-CV	insectagro DS2 serum-free/protein-free medium, 1x [-] L-glutamine	2°C to 8°C	12 m	500 mL	6

### Corning insectagro Sf9 Serum-free/Protein-free Medium

The insectagro Sf9 is formulated to support the propagation of Sf9 insect cells in culture, and can also be used with Sf21 cells. Sf9 cells cultured in non-humidified, non-CO<sub>2</sub> incubators at 27°C (room temperature) display both monolayer and suspension culture qualities. With their fast doubling times of 18 to 22 hours, Sf9 cells are easily scaled up to large cultures using bioreactors.

**Liquid** 📌

Cat. No.	Description	Storage	Shelf Life	Size	Qty/Pk
13-410-CV	insectagro Sf9 serum-free/protein-free medium [+] L-glutamine	2°C to 8°C	12 m	500 mL	6





## Islet Solutions

Islet cell isolation and processing for diabetes research requires a variety of specialized cell culture media, separation and gradient solutions, porcine-specific solutions, and related isolation, trimming, and storage/preservation solutions. Most islet solutions have been customized to include or leave out components such as insulin, transferrin, HSA, ciprofloxacin, and HEPES.

Corning's portfolio of specialized media has been cited in multiple islet cell isolation protocols for type 1 diabetes research.

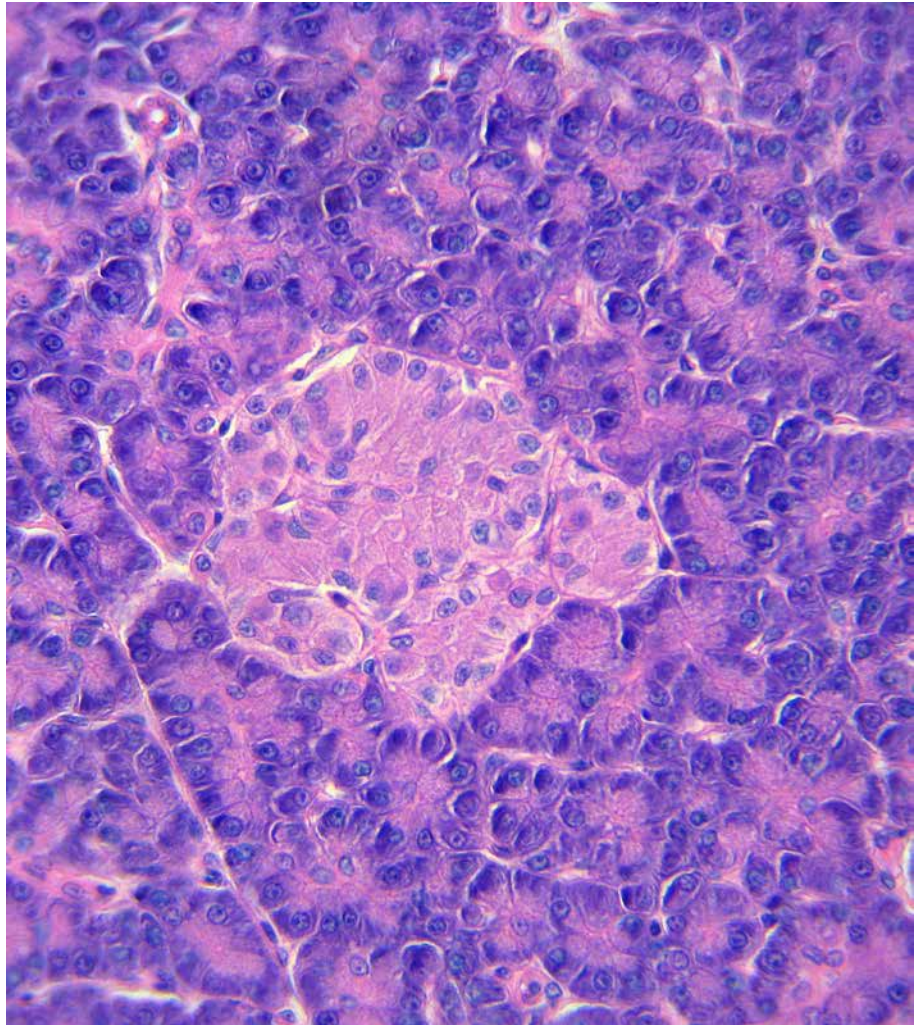

## Islet Solutions and Reagents

### Liquid

Cat. No.	Description	Storage	Shelf Life	Size	Qty/Pk
98-021-CV	Miami medium #1A with HSA and sodium bicarbonate	2°C to 8°C	18 m	500 mL	1
98-304-CV	CMRL 1066, supplemented, CIT modification	2°C to 8°C	18 m	500 mL	1
99-603-CV	CMRL 1066, supplemented	2°C to 8°C	18 m	500 mL	1
99-663-CV	CMRL 1066 without phenol red, L-glutamine	2°C to 8°C	18 m	500 mL	1
99-595-CM	RPMI 1640 with L-glutamine	2°C to 8°C	18 m	1 L	1
99-597-CM	HBSS (Hank's Balanced Salt Solution), modified for islets	2°C to 8°C	18 m	1 L	1
99-674-CM	Gradient stock solution, density 1.110 to 1.121 g/cm <sup>3</sup>	2°C to 8°C	24 m	1 L	1
99-676-CM	Trimming solution	2°C to 8°C	24 m	1 L	1
99-677-CM	Cold storage/purification stock solution, density 1.026 to 1.032 g/cm <sup>3</sup>	2°C to 8°C	18 m	1 L	1
99-678-CM	Phase I solution	2°C to 8°C	24 m	1 L	1
99-723-CM	Penta starch, 10% solution	2°C to 8°C	18 m	1 L	1
99-781-CV	Perfusion solution with HEPES, without phenol red	2°C to 8°C	24 m	500 mL	1
99-782-CM	Priming solution with HEPES, without phenol red, and sodium bicarbonate	15°C to 30°C	24 m	1 L	1
99-783-CM	Dilution solution, RPMI 1640 with HEPES, L-glutamine, without HSA and phenol red	2°C to 8°C	18 m	1 L	1
99-784-CM	Wash solution, medium 199 with 25 mM HEPES, without phenol red, L-glutamine, and sodium bicarbonate	2°C to 8°C	18 m	1 L	1
99-785-CV	Final wash/culture medium, CMRL 1066 without phenol red, with HSA, HEPES, and L-glutamine	2°C to 8°C	18 m	500 mL	1
99-786-CV	Functionality/viability solution, CMRL 1066 without glucose	2°C to 8°C	12 m	500 mL	1

## Cell Separation and Gradient Solutions

### Liquid

Cat. No.	Description	Storage	Shelf Life	Size	Qty/Pk
99-662-CVS	Stock Polysucrose solution (Euro-Collins), density 1.132 g/cm <sup>3</sup>	2°C to 8°C	12 m	350 mL	1
99-690-CIS	Islet gradient, density 1.037 g/cm <sup>3</sup>	2°C to 8°C	12 m	75 mL	1
99-691-CIS	Islet gradient, density 1.096 g/cm <sup>3</sup>	2°C to 8°C	12 m	75 mL	1
99-692-CIS	Islet gradient, density 1.108 g/cm <sup>3</sup>	2°C to 8°C	12 m	75 mL	1
99-815-CIS	Islet gradient, density 1.069 g/cm <sup>3</sup>	2°C to 8°C	12 m	75 mL	1
25-072-CI	LSM (Lymphocyte Separation Medium), density 1.077 g/cm <sup>3</sup>	15°C to 30°C	18 m	100 mL	1
25-072-CV	LSM (Lymphocyte Separation Medium), density 1.077 g/cm <sup>3</sup>	15°C to 30°C	18 m	500 mL	1
61-196-RM	Polysucrose 400	15°C to 30°C	≥12 m	100 g	1
61-196-RO	Polysucrose 400	15°C to 30°C	≥12 m	500 g	1

## Porcine Solutions

### Liquid

Cat. No.	Description	Storage	Shelf Life	Size	Qty/Pk
98-343-CV	Neonatal porcine islet culture medium	2°C to 8°C	*	500 mL	1
99-601-CM	Medium 199, porcine modification, with 25 mM HEPES, without phenol red, L-glutamine, and sodium bicarbonate	2°C to 8°C	*	1L	1

\*Please inquire for lot-specific expiration dates or view current certificate of analysis at [www.corning.com/lifesciences/media](http://www.corning.com/lifesciences/media).

## Preservation Solutions

### Liquid

Cat. No.	Description	Storage	Shelf Life	Size	Qty/Pk
99-408-CM	Glucose solution (Euro-Collins)	15°C to 30°C	24 m	1L	1
99-409-CI	Electrolyte additive solution (Euro-Collins)	15°C to 30°C	24 m	100 mL	1

## Human and Animal Sera

Our high-quality serum products perfectly complement our wide range of sterile-filtered, low-endotoxin, classical cell culture media.

Premium Fetal Bovine Serum is U.S.-sourced, with low endotoxin and hemoglobin specifications and is collected from cattle herds located within the United States. It is also available heat-inactivated.



### Fetal Bovine Serum

Fetal Bovine Serum (FBS) is a light brown-colored liquid separated from the blood of the bovine fetus. All material meets the approval of the USDA and is obtained from sources free of BSE, FMD, and other reportable diseases pertaining to the species.

#### Liquid

Cat. No.	Description	Storage	Shelf Life	Size	Qty/Pk
35-015-CV	Fetal Bovine Serum, premium	-25°C to -15°C	*	500 mL	1
35-016-CV	Fetal Bovine Serum, premium (heat inactivated)	-25°C to -15°C	*	500 mL	1
35-070-CV	Fetal Bovine Serum, Premium (Gamma Irradiated)	-25°C to -15°C	*	500 mL	1
35-076-CV	Fetal Bovine Serum, Australia origin	-25°C to -15°C	*	500 mL	1
35-079-CV	Fetal bovine serum, EU compliant, South America Origin	-25°C to -15°C	*	500 mL	1

\*Please inquire for lot-specific expiration dates or view the current certificate of analysis at [www.corning.com/lifesciences/media](http://www.corning.com/lifesciences/media).

### Human AB Serum

Human AB Serum is processed from donor plasma collected at U.S. centers. Each donor unit of plasma is negative for Hepatitis B (HBsAg), Hepatitis C (anti-HCV), Human Immunodeficiency Virus-1 (HIV-1), Human Immunodeficiency Virus-2 (HIV-2), Human Immunodeficiency Virus antibody (HIV-1Ag), and alanine aminotransferase (ALT) using FDA approved methods.

#### Liquid

Cat. No.	Description	Storage	Shelf Life	Size	Qty/Pk
35-060-CI	Human AB serum	-25°C to -15°C	*	100 mL	1

\* Please inquire for lot-specific expiration dates or view the current certificate of analysis at [www.corning.com/lifesciences/media](http://www.corning.com/lifesciences/media).

## Cell Culture Reagents

Growth media is used either for cell culture or microbiological culture. These cultures require nutrients, supplements, buffers, and other reagents specific to the product being grown to maximize results and consistency.

There are two major types of growth media: those used for cell culture, which use specific cell types derived from plants or animals, and microbiological culture, which are used for growing microorganisms, such as bacteria or yeast.

Specialized media are sometimes required for microorganism and cell culture growth. Some organisms, termed fastidious organisms, require specialized environments due to complex nutritional requirements. Viruses, for example, are obligate intracellular parasites and require a growth medium composed of living cells.





## AMINO ACIDS AND VITAMINS

Supplementation table for L-glutamine and Corning® glutagro™ supplement.

Media	mg/L	mM	200 mM L-glutamine (25-005) or 200 mM Corning glutagro Supplement (25-015)
AMEM	292	2.00	10.0 mL/L
BME	292.3	2.00	10.0 mL/L
DMEM	584	4.00	20.0 mL/L
DMEM/F12	362.1	2.48	12.4 mL/L
F12K	292	2.00	10.0 mL/L
Ham's F-10	146.2	1.00	5.0 mL/L
Ham's F-12	146.2	1.00	5.0 mL/L
Iscove's DMEM	584	4.00	20.0 mL/L
M199	100	0.68	3.4 mL/L
EMEM	292	2.00	10.0 mL/L
RPMI 1640	300	2.05	10.3 mL/L

### Corning glutagro Supplement

The glutagro supplement is a stabilized dipeptide form of L-glutamine which does not degrade in liquid media during storage or incubation, providing superior results in several applications.

#### Liquid

Cat. No.	Description	Storage	Shelf Life	Size	Qty/Pk
25-015-Cl	glutagro supplement, 200 mM solution, 100x (with 8.5 g/L NaCl)	2°C to 30°C	24 m	100 mL	1

### L-glutamine

#### Liquid

Cat. No.	Description	Storage	Shelf Life	Size	Qty/Pk
25-005-Cl	L-glutamine, 200 mM solution, 100x (with 8.5 g/L NaCl)	-25°C to -15°C	24 m	500 mL	6
25-005-CV	L-glutamine, 200 mM solution, 100x (with 8.5 g/L NaCl)	-25°C to -15°C	24 m	500 mL	6

#### Powder

Cat. No.	Description	Storage	Shelf Life	Size	Qty/Pk
61-030-RM	L-glutamine	2°C to 8°C	12 m	100 g	1
61-030-RO	L-glutamine	2°C to 8°C	12 m	500 g	1
61-030-RR	L-glutamine	2°C to 8°C	12 m	1 kg	1

### MEM Amino Acids

#### Liquid

Cat. No.	Description	Storage	Shelf Life	Size	Qty/Pk
25-030-CIR	[-] L-glutamine, 50x	2°C to 8°C	36 m	100 mL	6

### MEM Non-essential Amino Acids

#### Liquid

Cat. No.	Description	Storage	Shelf Life	Size	Qty/Pk
25-025-CIR	MEM non-essential amino acids, 100x	2°C to 8°C	18 m	100 mL	6

### MEM Vitamins

#### Liquid

Cat. No.	Description	Storage	Shelf Life	Size	Qty/Pk
25-020-Cl	MEM vitamins, 100x	-25°C to -15°C	18 m	100 mL	6



## ANTIBIOTICS AND ANTIMYCOTICS

### Amphotericin B

#### Liquid ♦

Cat. No.	Description	Storage	Shelf Life	Size	Qty/Pk
30-003-CF	Amphotericin B, liquid	-25°C to -15°C	18 m	50 mL	6

### Ampicillin Sodium Salt

#### Powder ⚡

Cat. No.	Description	Storage	Shelf Life	Size	Qty/Pk
61-238-RH	Ampicillin sodium salt	2°C to 8°C	≥12 m	10 g	1
61-238-RM	Ampicillin sodium salt	2°C to 8°C	≥12 m	100 g	1

### Antibiotic-Antimycotic Solution

#### Liquid ♦

Cat. No.	Description	Storage	Shelf Life	Size	Qty/Pk
30-004-CI	10,000 I.U. Penicillin (per mL), 10,000 µg/mL Streptomycin, 25 µg/mL Amphotericin with 8.5 g/L NaCl	-25°C to -15°C	18 m	100 mL	6

### Blasticidin S HCl

#### Powder ⚡

Cat. No.	Description	Storage	Shelf Life	Size	Qty/Pk
30-100-RB	Blasticidin S HCl	-25°C to -15°C	18 m	50 mg	1

### Chloramphenicol

#### Powder ⚡

Cat. No.	Description	Storage	Shelf Life	Size	Qty/Pk
61-239-RI	Chloramphenicol	15°C to 25°C	≥12 m	25 g	1

### Ciprofloxacin Hydrochloride

#### Powder ⚡

Cat. No.	Description	Storage	Shelf Life	Size	Qty/Pk
61-277-RF	Ciprofloxacin hydrochloride	15°C to 25°C	≥12 m	1 g	1
61-277-RG	Ciprofloxacin hydrochloride	15°C to 25°C	≥12 m	5 g	1

### G418 Sulfate

#### Liquid ♦

Cat. No.	Description	Storage	Shelf Life	Size	Qty/Pk
30-234-CR	G418 Sulfate, 50 mg/mL solution	2°C to 8°C	≥12 m	20 mL	1
30-234-CI	G418 Sulfate, 50 mg/mL solution	2°C to 8°C	≥12 m	100 mL	1

#### Powder ⚡

Cat. No.	Description	Storage	Shelf Life	Size	Qty/Pk
61-234-RF	G418 Sulfate, potency >700 µg/mg	15°C to 30°C	≥12 m	1 g	1
61-234-RG	G418 Sulfate, potency >700 µg/mg	15°C to 30°C	≥12 m	5 g	1
61-234-RK	G418 Sulfate, potency >700 µg/mg	15°C to 30°C	≥12 m	50 kg	1

## Gentamicin Sulfate

### Liquid

Cat. No.	Description	Storage	Shelf Life	Size	Qty/Pk
30-005-CR	Gentamicin sulfate	15°C to 30°C	12 m	10 mL	10

### Powder

Cat. No.	Description	Storage	Shelf Life	Size	Qty/Pk
61-098-RA	Gentamicin sulfate	2°C to 8°C	≥12 m	100 mg	1
61-098-RF	Gentamicin sulfate	2°C to 8°C	≥12 m	1 g	1

## Hygromycin B Solution

### Liquid

Cat. No.	Description	Storage	Shelf Life	Size	Qty/Pk
30-240-CR	Hygromycin B solution	2°C to 8°C	18 m	20 mL	1

## Kanamycin Sulfate

### Liquid

Cat. No.	Description	Storage	Shelf Life	Size	Qty/Pk
30-006-CF	Kanamycin sulfate	-25°C to -15°C	18 m	50 mL	6

### Powder

Cat. No.	Description	Storage	Shelf Life	Size	Qty/Pk
61-176-RG	Kanamycin sulfate	15°C to 30°C	18 m	5 g	1

## Neomycin Sulfate

### Powder

Cat. No.	Description	Storage	Shelf Life	Size	Qty/Pk
61-241-RG	Neomycin sulfate	15°C to 30°C	18 m	5 g	1

## Penicillin-Streptomycin Solution

### Liquid

Cat. No.	Description	Storage	Shelf Life	Size	Qty/Pk
30-001-CI	Penicillin-Streptomycin solution, 50x	-25°C to -15°C	12 m	100 mL	6
30-002-CI	Penicillin-Streptomycin solution, 100x	-25°C to -15°C	12 m	100 mL	6
30-009-CI	Penicillin-Streptomycin solution, 100x [+] 29.2 mg/mL L-glutamine	-25°C to -15°C	12 m	100 mL	6

## Puromycin Dihydrochloride

### Powder

Cat. No.	Description	Storage	Shelf Life	Size	Qty/Pk
61-385-RA	Puromycin dihydrochloride	-25°C to -15°C	12 m	0.1 g	1

## Streptomycin Sulfate

### Powder

Cat. No.	Description	Storage	Shelf Life	Size	Qty/Pk
61-088-RM	Streptomycin sulfate	15°C to 30°C	12 m	100 g	1

## Tetracycline Hydrochloride

### Powder

Cat. No.	Description	Storage	Shelf Life	Size	Qty/Pk
61-242-RG	Tetracycline hHydrochloride	15°C to 30°C	12 m	5 g	1

## BUFFERS

### HEPES

#### Liquid

Cat. No.	Description	Storage	Shelf Life	Size	Qty/Pk
25-060-CI	HEPES, 1M solution (238.3 mg/mL)	15°C to 30°C	24 m	100 mL	6

#### Powder

Cat. No.	Description	Storage	Shelf Life	Size	Qty/Pk
61-034-RM	HEPES	15°C to 30°C	≥12 m	100 g	1
61-034-RO	HEPES	15°C to 30°C	≥12 m	500 g	1
61-034-RR	HEPES	15°C to 30°C	≥12 m	1 kg	1

### Sodium Bicarbonate

#### Liquid

Cat. No.	Description	Storage	Shelf Life	Size	Qty/Pk
25-035-CI	Sodium bicarbonate, 7.5% solution	15°C to 30°C	36 m	100 mL	6

#### Powder

Cat. No.	Description	Storage	Shelf Life	Size	Qty/Pk
61-065-RO	Sodium bicarbonate	15°C to 30°C	≥12 m	500 g	1
61-065-RR	Sodium bicarbonate	15°C to 30°C	≥12 m	1 kg	1

## ENZYMATIC CELL DISSOCIATION AGENTS

### Accutase® Cell Detachment Solution

Accutase is an effective solution for routinely detaching cells from standard tissue culture-treated vessels, as well as advanced surface treatments or coatings. Accutase is useful for cell detachment and for preparing single-cell suspensions from clumped cell populations for sub-culturing cells, analytical studies, and for accurate cell counting. Accutase is free of mammalian or bacterial-derived products, which reduces the risk of contamination.

#### Liquid

Cat. No.	Description	Storage	Shelf Life	Size	Qty/Pk
25-058-CI	Accutase cell detachment solution	-25°C to -15°C	18 m	100 mL	1

### Trypsin

#### Liquid

Cat. No.	Description	Storage	Shelf Life	Size	Qty/Pk
25-050-CI	0.25% Trypsin in HBSS; [-] calcium, magnesium	-25°C to -15°C	12 m	100 mL	6
25-051-CI	0.05% Trypsin/0.53 mM EDTA in HBSS; [+] sodium bicarbonate, [-] calcium, magnesium	-25°C to -15°C	12 m	100 mL	6
25-052-CI	0.05% Trypsin/0.53 mM EDTA in HBSS; [-] sodium bicarbonate, calcium, magnesium	-25°C to -15°C	12 m	100 mL	6
25-052-CV	0.05% Trypsin/0.53 mM EDTA in HBSS; [-] sodium bicarbonate, calcium, magnesium	-25°C to -15°C	12 m	500 mL	6
25-053-CI	0.25% Trypsin/2.21 mM EDTA in HBSS; [-] sodium bicarbonate, calcium, magnesium	-25°C to -15°C	12 m	100 mL	6
25-054-CI	2.5% Trypsin in HBSS; [-] calcium, magnesium, phenol red	-25°C to -15°C	12 m	100 mL	6

## NON-ENZYMATIC CELL DISSOCIATION AGENTS

### Corning® Cellstripper® Solution

Cellstripper Solution is a non-enzymatic cell dissociation solution formulated with a proprietary mixture of chelators that gently dislodge adherent cells in tissue culture. It is an alternative to trypsin or Accutase® cell detachment solution when used with either serum-free or serum-supplemented media. Because Cellstripper Solution is a gentler reagent than trypsin, cells can be exposed to Cellstripper Solution for longer periods of time. Cellstripper Solution achieves superior results in comparison to enzymatic dissociation products.

#### Liquid 📌

Cat. No.	Description	Storage	Shelf Life	Size	Qty/Pk
25-056-CI	Cellstripper Solution	15°C to 30°C	12 m	100 mL	6

## GROWTH SUPPLEMENTS

### ITS (Insulin, Transferrin, Selenium)

#### Liquid 📌

Cat. No.	Description	Storage	Shelf Life	Size	Qty/Pk
25-800-CR	ITS (Insulin, Transferrin, Selenium), 100x	2°C to 8°C	18 m	10 mL	1

### rhAlbumin

rhAlbumin is a chemically defined recombinant human serum albumin (rhHSA). Having an essential and non-essential fatty acid profile, this is a powerful media supplement that outperforms plasma-derived human serum albumin (pHSA), bovine serum albumin (BSA), and FBS. Some prominent applications for rhAlbumin are as a supplement for CHO cell culture and for the culture of various other cell lines. This product is plant-derived and completely animal-free.

#### Powder 📌

Cat. No.	Description	Storage	Shelf Life	Size	Qty/Pk
62-450-RF	rhAlbumin	-20°C to 8°C	12 m	1 g	1

### Trace Elements A

Trace Elements A provides copper, zinc, iron and selenium. Selenium aids in the detoxification of free radicals as a cofactor for GSH synthetase, while iron, copper, and zinc may be bound by serum protein. The combination of Trace Elements A and B contains the trace elements of MCDB 104.

#### Liquid 📌

Cat. No.	Description	Storage	Shelf Life	Size	Qty/Pk
25-021-CI	Trace Elements A, 1000x solution	15°C to 30°C	*	100 mL	1

\*Please inquire for lot-specific expiration dates or view the current certificate of analysis at [www.corning.com/lifesciences/media](http://www.corning.com/lifesciences/media).

### Trace Elements B

Trace Elements B has the same composition as Cleveland's Trace Elements I. The combination of Trace Elements A, B, and C contains the trace elements of MCDB 301.

#### Liquid 📌

Cat. No.	Description	Storage	Shelf Life	Size	Qty/Pk
25-022-CI	Trace Elements B, 1000x solution	2°C to 8°C	*	100 mL	1

\*Please inquire for lot-specific expiration dates or view the current certificate of analysis at [www.corning.com/lifesciences/media](http://www.corning.com/lifesciences/media).

### Trace Elements C

Trace Elements C has the same composition of Cleveland's Trace Elements II, and the combination of Trace Elements A, B, and C contains the trace elements of MCDB 301.

#### Liquid 📌

Cat. No.	Description	Storage	Shelf Life	Size	Qty/Pk
25-023-CI	Trace Elements C, 1000x solution	2°C to 8°C	*	100 mL	1

\*Please inquire for lot-specific expiration dates or view the current certificate of analysis at [www.corning.com/lifesciences/media](http://www.corning.com/lifesciences/media).

## HYBRIDOMA REAGENTS

### HAT (Hypoxanthine, Aminopterin, Thymidine)

Liquid 

Cat. No.	Description	Storage	Shelf Life	Size	Qty/Pk
25-046-CI	HAT (Hypoxanthine, Aminopterin, Thymidine), 50x	-25°C to -15°C	28 m	100 mL	1

### HT (Hypoxanthine, Thymidine)

Liquid 

Cat. No.	Description	Storage	Shelf Life	Size	Qty/Pk
25-047-CI	HT (Hypoxanthine, Thymidine), 50x	2°C to 8°C	20 m	100 mL	1

## INSECT REAGENTS

### Poloxamer 188

Poloxamer 188 is a synthetic polymer of sucrose and epichlorohydrin used for the density gradient separation of cells, cell membranes, and virus cells. It can also be used to isolate different organelles. This nonionic compound is provided in powder and liquid forms.

Liquid 

Cat. No.	Description	Storage	Shelf Life	Size	Qty/Pk
13-901-CI	Poloxamer 188	2°C to 8°C	12 m	100 mL	6

Powder 

Cat. No.	Description	Storage	Shelf Life	Size	Qty/Pk
61-161-RM	Poloxamer 188	15°C to 30°C	≥12 m	100 g	1

### Polysucrose 400

Powder 

Cat. No.	Description	Storage	Shelf Life	Size	Qty/Pk
61-196-RM	Polysucrose 400	15°C to 30°C	≥12 m	100 g	1
61-196-RO	Polysucrose 400	15°C to 30°C	≥12 m	500 g	1

## MISCELLANEOUS REAGENTS

### DMSO (Dimethyl Sulfoxide)

Liquid 

Cat. No.	Description	Storage	Shelf Life	Size	Qty/Pk
25-950-CQC	DMSO (Dimethyl sulfoxide)	15°C to 30°C	12 m	250 mL	1

### 45% Glucose Solution

Liquid 

Cat. No.	Description	Storage	Shelf Life	Size	Qty/Pk
25-037-CIR	45% Glucose solution	15°C to 30°C	24 m	100 mL	1

### Sodium Pyruvate

Liquid 

Cat. No.	Description	Storage	Shelf Life	Size	Qty/Pk
25-000-CIR	100 mM Sodium pyruvate solution with 8.5 g/L NaCl	2°C to 8°C	18 m	100 mL	6

### Tris Base Buffer

Powder 

Cat. No.	Description	Storage	Shelf Life	Size	Qty/Pk
61-233-RM	Tris base buffer	15°C to 30°C	>12 m*	100 g	1
61-233-RR	Tris base buffer	15°C to 30°C	>12 m*	1 kg	1
61-233-RT	Tris base buffer	15°C to 30°C	>12 m*	5 kg	1

\*Please inquire for lot-specific expiration dates or view the current certificate of analysis at [www.corning.com/lifesciences/media](http://www.corning.com/lifesciences/media).

### Trypan Blue Solution

Liquid 

Cat. No.	Description	Storage	Shelf Life	Size	Qty/Pk
25-900-CI	Trypan blue solution, 0.4% (w/v) in PBS, pH 7.5 ± 0.5	15°C to 30°C	24 m	100 mL	1

### Yeast Extract

Powder 

Cat. No.	Description	Storage	Shelf Life	Size	Qty/Pk
61-231-RO	Yeast extract	15°C to 30°C	20 m	500 g	1

## Microbiology and Molecular Biology

Our molecular biology product line ranges from microbiological media and components to molecular reagents and buffers. With a wide range of antibiotics to choose from, these products allow you to select your growth as well as ensure their viability and proliferation. Many of the antibiotics offered are members of the aminoglycoside family whose mechanism of action works by binding to the 30S ribosomal subunit.



Media, Sera, Reagents,  
Flexible Bags



### Miller's LB Broth

#### Liquid

Cat. No.	Description	Storage	Shelf Life	Size	Qty/Pk
46-050-CM	Miller's LB broth	15°C to 30°C	*	1L	6

\*Please inquire for lot-specific expiration dates or view the current certificate of analysis at [www.corning.com/lifesciences/media](http://www.corning.com/lifesciences/media).

### S.O.C. Medium

#### Liquid

Cat. No.	Description	Storage	Shelf Life	Size	Qty/Pk
46-003-CR	S.O.C. medium	15°C to 30°C	12 m	10 mL	10

### Terrific Broth

#### Liquid

Cat. No.	Description	Storage	Shelf Life	Size	Qty/Pk
46-055-CM	Terrific broth	15°C to 30°C	12 m	1L	6

### Ampicillin Sodium Salt

#### Powder

Cat. No.	Description	Storage	Shelf Life	Size	Qty/Pk
61-238-RH	Ampicillin sodium salt	2°C to 8°C	24-30 m	10 g	1
61-238-RM	Ampicillin sodium Salt	2°C to 8°C	24-30 m	100 g	1

### Carbenicillin Disodium Salt

#### Powder

Cat. No.	Description	Storage	Shelf Life	Size	Qty/Pk
46-100-RG	Carbenicillin disodium salt	2°C to 8°C	24-30 m	5 g	1

### Kanamycin Sulfate

#### Liquid

Cat. No.	Description	Storage	Shelf Life	Size	Qty/Pk
30-006-CF	Kanamycin sulfate	-25°C to -15°C	12 m	50 mL	6

#### Powder

Cat. No.	Description	Storage	Shelf Life	Size	Qty/Pk
61-176-RG	Kanamycin sulfate	15°C to 30°C	≥12 m	5 g	1

### Neomycin Sulfate

#### Powder

Cat. No.	Description	Storage	Shelf Life	Size	Qty/Pk
61-241-RG	Neomycin sulfate	15°C to 30°C	12 m	5 g	1

### Streptomycin Sulfate

#### Powder

Cat. No.	Description	Storage	Shelf Life	Size	Qty/Pk
61-088-RM	Streptomycin sulfate	2°C to 8°C	12 m	100 g	1

### Tetracycline Hydrochloride

Powder 

Cat. No.	Description	Storage	Shelf Life	Size	Qty/Pk
61-242-RG	Tetracycline hydrochloride	2°C to 8°C	12 m	5 g	1

### X-Gal

Powder 

Cat. No.	Description	Storage	Shelf Life	Size	Qty/Pk
46-101-RF	X-Gal	-25°C to -15°C	24 m	1 g	1

### IPTG (Isopropylthiogalactoside)

Powder 

Cat. No.	Description	Storage	Shelf Life	Size	Qty/Pk
46-102-RF	IPTG (Isopropylthiogalactoside)	-25°C to -15°C	36 m	1 g	1

## BUFFERS

### MOPS Buffer

Powder 

Cat. No.	Description	Storage	Shelf Life	Size	Qty/Pk
46-103-RM	MOPS buffer, pH 6.5-7.9	15°C to 30°C	*	100 g	1

\* Please inquire for lot-specific expiration dates or view the current certificate of analysis at [www.corning.com/lifesciences/media](http://www.corning.com/lifesciences/media).

### PBS (Phosphate Buffered Saline), 10x

Liquid 

Cat. No.	Description	Storage	Shelf Life	Size	Qty/Pk
46-013-CM	PBS, [-] Calcium, magnesium, pH 7.4 ± 0.1, RNase-/DNase- and protease-free, 10X	15°C to 30°C	24 m	1L	6

### SSC Buffer, 20x

Liquid 

Cat. No.	Description	Storage	Shelf Life	Size	Qty/Pk
46-020-CM	SSC buffer, pH 7.0 ± 0.1, RNase-/DNase- and protease-free, 20X	15°C to 30°C	24 m	1L	6

### SSPE Buffer, 20x

Liquid 

Cat. No.	Description	Storage	Shelf Life	Size	Qty/Pk
46-021-CM	SSPE buffer, pH 7.4 ± 0.1, RNase-/DNase- and protease-free, 20X	15°C to 30°C	18 m	1L	6

### TAE Buffer, 10x

Liquid 

Cat. No.	Description	Storage	Shelf Life	Size	Qty/Pk
46-010-CM	TAE buffer, pH 8.3 ± 0.1, RNase-/DNase- and protease-free, 10X	15°C to 30°C	24 m	1L	6

### TBE Buffer, 10x

Liquid 

Cat. No.	Description	Storage	Shelf Life	Size	Qty/Pk
46-011-CM	TBE buffer, pH 8.4 ± 0.1, RNase-/DNase- and protease-free, 10X	15°C to 30°C	24 m	1L	6

### TE Buffer, 1x

#### Liquid

Cat. No.	Description	Storage	Shelf Life	Size	Qty/Pk
46-009-CM	TE buffer, pH 7.9-8.1, RNase-/DNase- and protease-free, 1X	15°C to 30°C	12 m	1L	6

### Tris Buffered Saline, 10x

#### Liquid

Cat. No.	Description	Storage	Shelf Life	Size	Qty/Pk
46-012-CM	Tris buffered saline, pH 7.4 ± 0.1, RNase-/DNase- and protease-free, 10X	15°C to 30°C	12 m	1L	6

### Tris-HCl Buffers, 1M

#### Liquid

Cat. No.	Description	Storage	Shelf Life	Size	Qty/Pk
46-030-CM	Tris-HCl buffers, pH 7.5 ± 0.1, RNase-/DNase- and protease-free, 1M	15°C to 30°C	24 m	1L	6
46-031-CM	Tris-HCl buffers, pH 8.0 ± 1.0, RNase-/DNase- and protease-free, 1M	15°C to 30°C	24 m	1L	6

## REAGENTS

### EDTA, 0.5M

#### Liquid

Cat. No.	Description	Storage	Shelf Life	Size	Qty/Pk
46-034-CI	EDTA, 0.5M, pH 8.0	15°C to 30°C	24 m	100 mL	1

### SDS (Sodium Dodecyl Sulfate), 10%

#### Liquid

Cat. No.	Description	Storage	Shelf Life	Size	Qty/Pk
46-040-CI	SDS (Sodium Dodecyl Sulfate), 10%	15°C to 30°C	24 m	100 mL	1

### Sodium Acetate, 3M

#### Liquid

Cat. No.	Description	Storage	Shelf Life	Size	Qty/Pk
46-033-CI	Sodium acetate, 3M, pH 5.2 ± 0.1	15°C to 30°C	24 m	100 mL	1

### Sodium Chloride, 5M

#### Liquid

Cat. No.	Description	Storage	Shelf Life	Size	Qty/Pk
46-032-CV	Sodium chloride, 5M	15°C to 30°C	24 m	500 mL	6

## High-quality Water

Corning® high quality water is manufactured in our Mediatech, Inc. facility. Products are manufactured under the current ISO 13485 standard and the FDA Quality System Regulation 21 CFR 820, current good manufacturing practices (cGMP).

Corning offers a range of high quality water products for small and large volume requirements. These products reduce the expense of installing and maintaining your own water system, and ensure you have a secondary source of water that meets your specifications.

Corning high-quality water is available in a variety of sizes, and tested to specifications which may include USP and/or EP monograph requirements.



### Cell Culture Grade Water

Cell culture grade water is high-quality water suitable for use as a solvent in the preparation of cell culture media and other reagents for sensitive applications. Our bioprocess container selections are suitable for large-scale applications such as cleaning and upstream and downstream reagent preparation. Cell culture grade water goes through a wide array of testing which includes testing to the chemical and physical properties found in the USP and EP monographs for sterile Water for Injection (WFI).

#### Tested to USP sterile WFI specifications

Cat. No.	Description	Storage	Shelf Life	Size	Qty/Pk
25-055-CI	Water, cell culture grade	15°C to 30°C	36 m	100 mL	6
25-055-CV	Water, cell culture grade	15°C to 30°C	36 m	500 mL	6
25-055-CVC	Water, cell culture grade, with septum cap	15°C to 30°C	36 m	500 mL	6
25-055-CM	Water, cell culture grade	15°C to 30°C	36 m	1L	6
25-055-LB	Water, cell culture grade	15°C to 30°C	36 m	20L	1
25-055-LG	Water, cell culture grade	15°C to 30°C	36 m	100L	1
25-055-LH	Water, cell culture grade	15°C to 30°C	36 m	200L	1

#### Tested to USP and EP sterile WFI specifications

Cat. No.	Description	Storage	Shelf Life	Size	Qty/Pk
25-065-LBR	Water, cell culture grade	15°C to 30°C	36 m	20L	1
25-065-LGR	Water, cell culture grade	15°C to 30°C	36 m	100L	1
25-065-LHR	Water, cell culture grade	15°C to 30°C	36 m	200L	1

### Molecular Biology Grade Water

Molecular biology grade water is ideal for applications where highly pure, RNase-, DNase-, and protease-free water is required (e.g., PCR and other molecular biology reactions setup, DNA/RNA/protein extraction, purification, and storage reagents). Molecular biology grade water is tested to the chemical and physical properties found in the USP monograph for sterile purified water.

Cat. No.	Description	Storage	Shelf Life	Size	Qty/Pk
46-000-CI	Water, molecular biology grade	15°C to 30°C	24 m	100 mL	6
46-000-CV	Water, molecular biology grade	15°C to 30°C	24 m	500 mL	6
46-000-CM	Water, molecular biology grade	15°C to 30°C	24 m	1L	6

### Reagent Grade Water

Reagent grade water is suitable for the preparation of reagents, rinsing glassware and plasticware, cleaning electrodes and other common laboratory tasks requiring highly pure, RNase-, DNase-, and protease-free water. To ensure product quality, reagent grade water is tested to the chemical and physical properties found in the USP monograph for purified water.

Cat. No.	Description	Storage	Shelf Life	Size	Qty/Pk
46-002-LF	Water, reagent grade	15°C to 30°C	*	4L	2

\* Please inquire for lot-specific expiration dates or view the current certificate of analysis at [www.corning.com/lifesciences/media](http://www.corning.com/lifesciences/media)

## Flexible Packaging Systems

Corning® flexible packaging systems are available in multiple formats. They include custom configurations to meet your exact requirements. Our single-use bags are designed to be practical and cost-effective alternatives to rigid-walled containers. They are fabricated to match your specific application with a variety of bag sizes and tubing/connector configurations available. These containment and delivery systems preserve the physical, chemical, and functional characteristics of sterile and process fluids.

### Features and Benefits

- ▶ High-quality barrier films
- ▶ Sterile
- ▶ Gas and moisture barriers to minimize transmission of oxygen, carbon dioxide and water vapor
- ▶ Universal connection systems
- ▶ Reduces costs associated with washing, sterilization, and SIP/CIP validations
- ▶ Reduces the risks associated with cross-contamination
- ▶ Minimal setup time
- ▶ Wide variety of standard configurations
- ▶ Easily integrated in automated systems

### Industry Recognized Manufacturing Standards

- ▶ cGMP and ISO 13485 manufacturing process
- ▶ Complete documentation and traceability
- ▶ Animal-free manufacturing process



## COLLECTION CONTAINERS

Corning® collection containers are available in 2D hanging configurations and multiple bag volumes with multiple connector configurations.

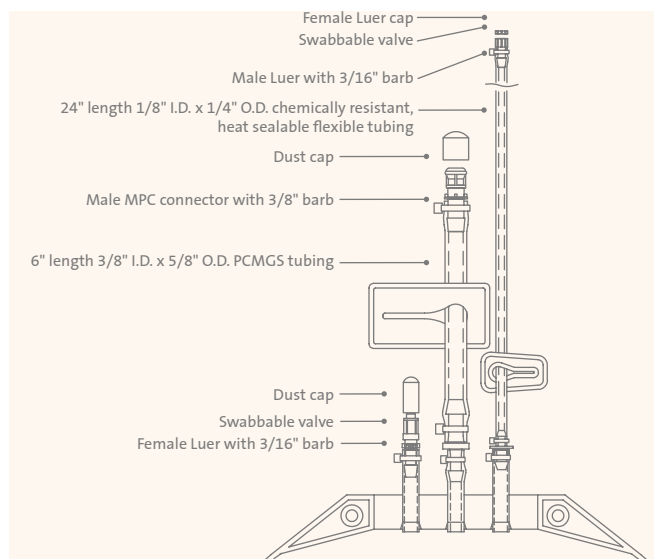

Cat. No.	Film Type	Size	Qty/Pk
91-200-01	EVA	1L	1
91-200-02	EVA	2L	1
91-200-05	EVA	5L	1
91-200-10	EVA	10L	1
91-200-20	EVA	20L	1

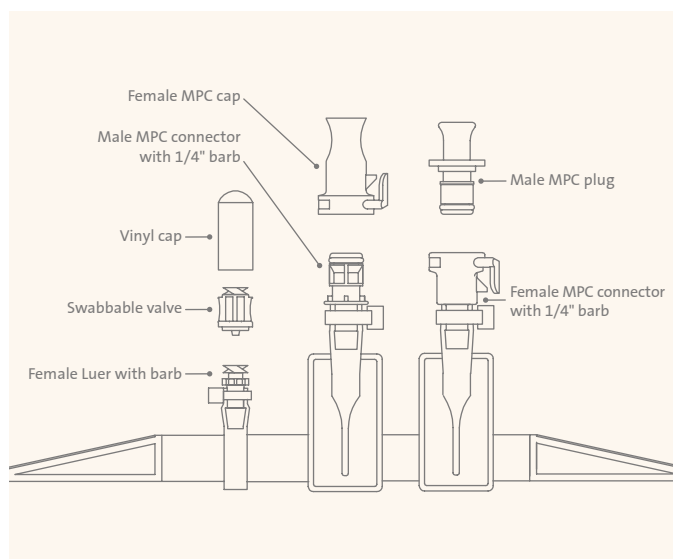

Cat. No.	Film Type	Size	Qty/Pk
91-200-36	EVA	10L	1
91-200-39	EVA	20L	1

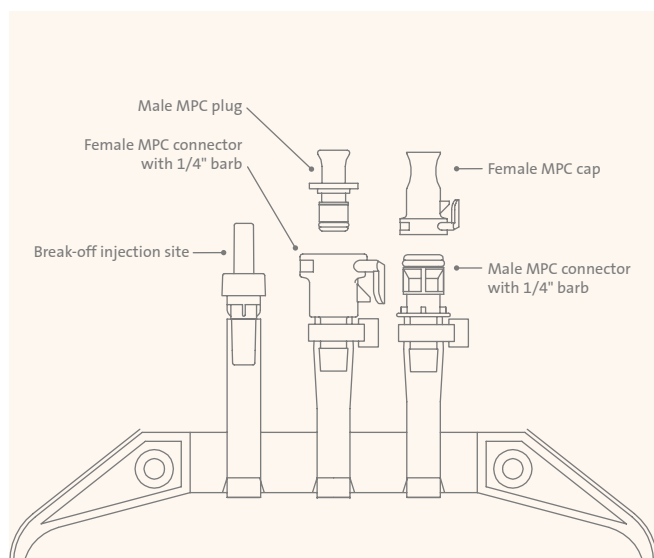

Cat. No.	Film Type	Size	Qty/Pk
91-200-41	EVA	500 mL	1
91-200-42	EVA	1L	1

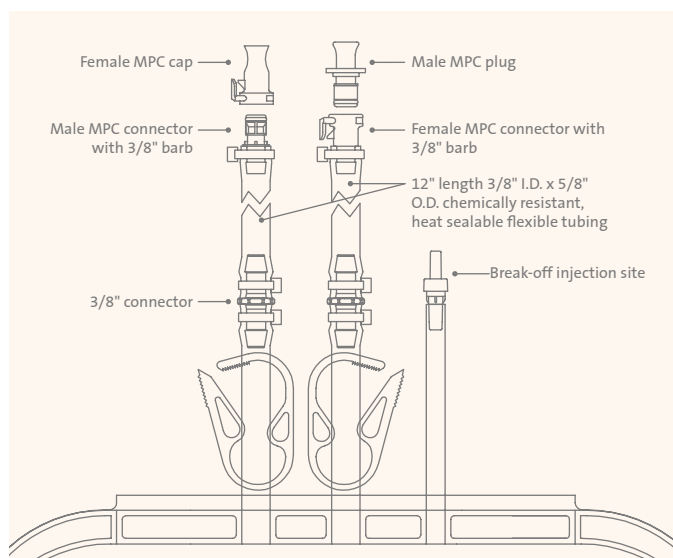

Cat. No.	Film Type	Size	Qty/Pk
91-200-43	EVA	5L	1
91-200-45	EVA	10L	1
91-200-47	EVA	20L	1
91-200-48	EVA	50L	1

Media, Sera, Reagents, Flexible Bags



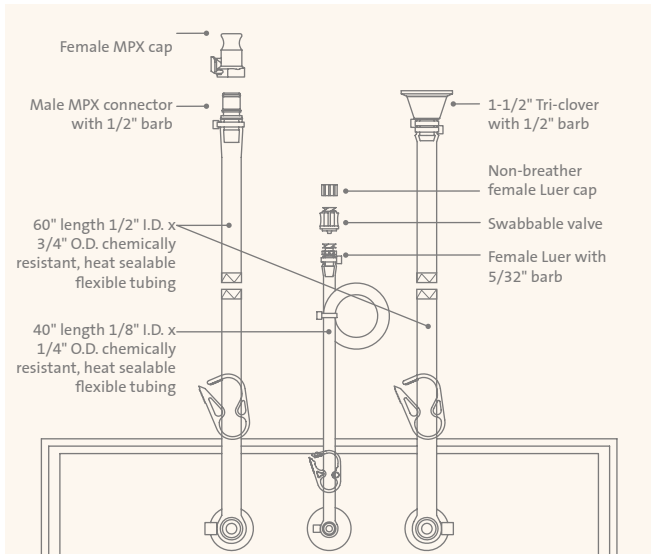

Cat. No.	Film Type	Size	Qty/Pk
91-200-82	ULDPE	100L	1
91-200-83	ULDPE	200L	1

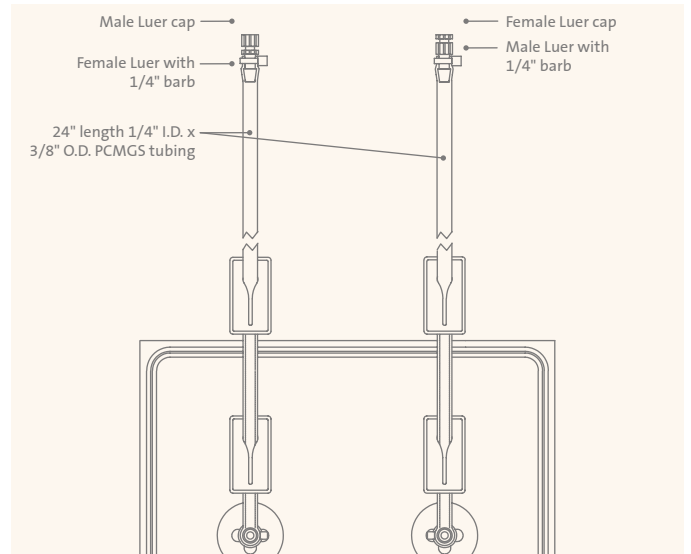

Cat. No.	Film Type	Size	Qty/Pk
91-002-MX	Metallocene	10L	1
91-001-MB	Metallocene	25L	1

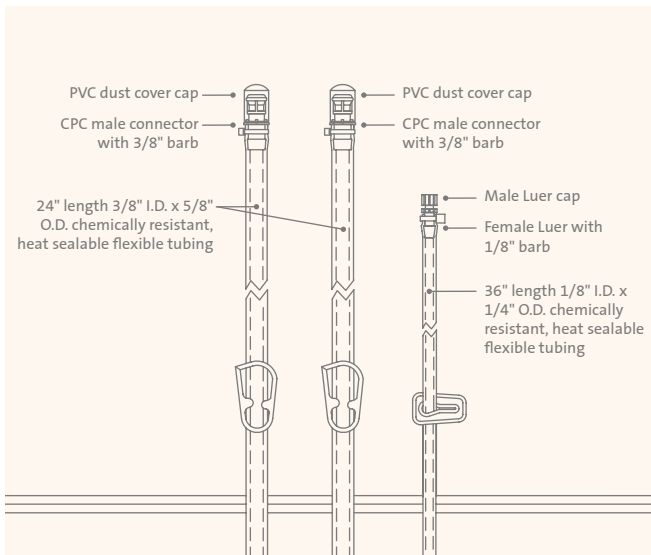

Cat. No.	Film Type	Size	Qty/Pk
91-100-30	Metallocene	50L	1
91-100-35	Metallocene	100L	1

## CELL EXPANSION BAGS

Cell expansion bags are intended for the expansion and culture of non-adherent cells. The containers are made from single-web polyolefin, gas permeable film. The integrated tubing allows for functionally closed system filling, feeding, and sampling.

### Features and Benefits

- ▶ Cell expansion observed with multiple cell models
- ▶ Gas permeable film
- ▶ Reusable sampling valve for in process testing
- ▶ Tubing for sterile weld connections
- ▶ Scalable, user friendly design

Biocompatibility Tests	Result	Test Protocol
USP Class VI	Pass	USP <88>
Toxicity	Pass	USP <87>
Heavy metals	<2 ppm	ISO 3826-1
Buffering capacity	1.22 mL	USP <661>
Non-volatile residue	8.6 mg	USP <661>
Residue on ignition (polyolefins)	<1 mg	ISO 3826-1
Acidity and alkalinity	Pass	ISO 3826-1
Oxidizable constituents	<1.5 mL	ISO 3826-1
Absorbance	<0.2 abs unit	ISO 3826-1
Reducing substances	0.34 mL	EP 3.1.14
Local effects after implantation	Pass	ISO 10993-6
Irritation and delayed-type sensitivity	Pass	ISO 10993-10
Systemic toxicity	Pass	ISO 10993-11

Physical Properties	Result	Test Protocol
O <sub>2</sub> transmission (cm <sup>3</sup> /100 in <sup>2</sup> /24 hrs) at (25°C; 0% RH)	153	ASTM D-3985
CO <sub>2</sub> transmission (cm <sup>3</sup> /100 in <sup>2</sup> /24 hrs) at (25°C; 0% RH)	1183	MOCON Test Method
Moisture vapor transmission (g/100 in <sup>2</sup> /24 hrs)	0.94	ASTM D-1249
Transmittance (%)	83	ASTM D-1003
Tensile strength (psi)	3400/3700	ASTM D-638
Elastic modulus (E)	540/480	ASTM D-638

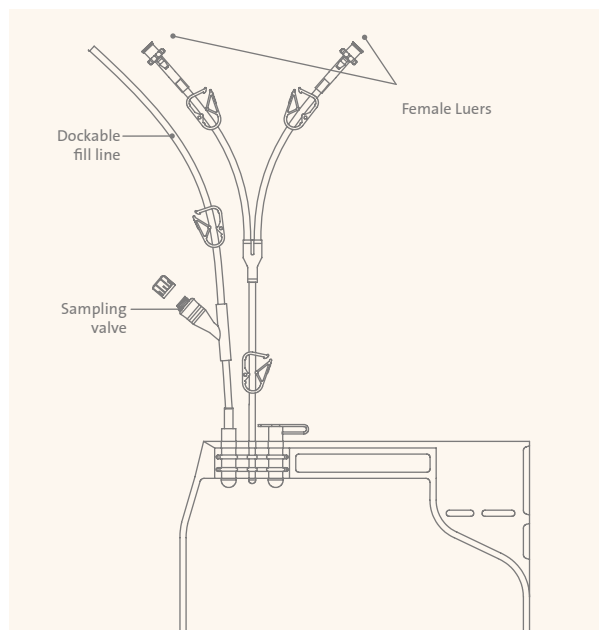

Cat. No.	Size	Fill Volume	Qty/Pk
91-200-84	500 mL	190 mL	1
91-200-85	1L	381 mL	1
91-200-86	3 L	633 mL	1
91-200-87	5L	1252 mL	1

## CRYOPRESERVATION BAGS

Cryogenic storage containers are designed for storage, preservation, and transfer of cells.

### Design Offers

- ▶ Unique bag film material remains flexible at ultra-low temperatures (-196°C).
- ▶ Proprietary membrane port design offers thinner walls for increased flexibility and attached cap minimizes membrane exposure during freezing
- ▶ Industry standard label pocket design offers ease-of-use and traceability in labeling

### Features and Benefits

- ▶ Polyolefin film – Proprietary EVA blend specifically selected for its low temperature properties while maintaining flexibility and clarity when filled with liquid
- ▶ Membrane port – The attached cap snaps into place to protect the contents and minimizes membrane exposure during use
- ▶ Label pocket – Supports use of computer-generated labels; product information can be viewed quickly by simply opening the freezing cassette
- ▶ Integral fill tube – The unique manufacturing method used to secure the fill tube to the container body eliminates the need for PVC interfaces with the liquid nitrogen storage section of the container
- ▶ Interface/Connectors – Compatible with sterile connection technology and smart seal technology (Sebra® Model 1100 tube welder); fits in a variety of freezing cassette systems

### Physical Integrity

The physical integrity of the containers were evaluated for their ability to withstand temperature variations experienced during routine storage of hematopoietic progenitor cell products. All containers passed the physical integrity tests performed, which included the initial pressure test and leak tests and the microbial challenge and dye immersion tests.

### Cell Quality

Cell quality was assessed on our cryogenic storage containers using diluted HPC with 10% DMSO. All containers met the acceptance requirement for MNC and CD34+ cell recovery of ≥70% relative to cell counts of the sample prior to cryopreservation. The average MNC and CD34+ cell recoveries were 81% and 84%, respectively. All containers met ≥ 1 CFU acceptance criteria with an average of 78% recovery.

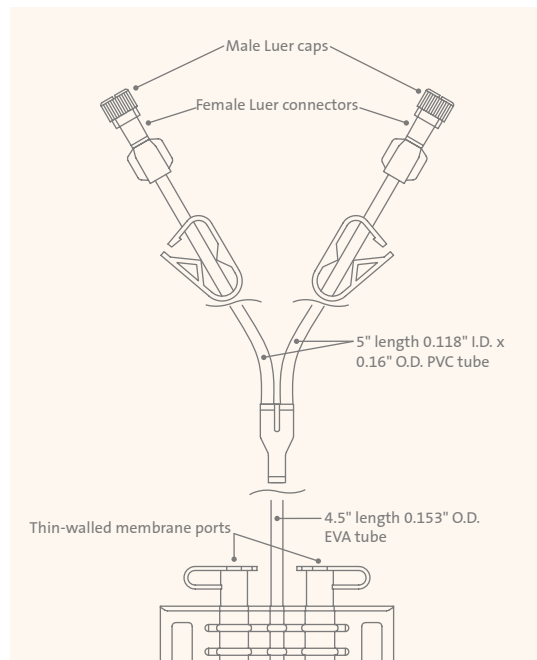

Cat. No.	Size	Fill Volume	Qty/Pk
91-200-88	50 mL	10 - 20 mL	1
91-200-89	250 mL	30 - 70 mL	1
91-200-90	500 mL	55 - 100 mL	1
91-200-91	750 mL	80 - 190 mL	1

## ROCKER CELL CULTURE BAGS

Rocker cell culture bags are designed for use with commercial rocking-motion bioreactor chambers. They feature ethylene vinyl acetate/ultra-low density polyethylene (ULDPE) 9101 film and stability bars on each side. This sterile single-use cell culture bag is ideal for basic research to large-scale biopharmaceutical manufacturing applications.

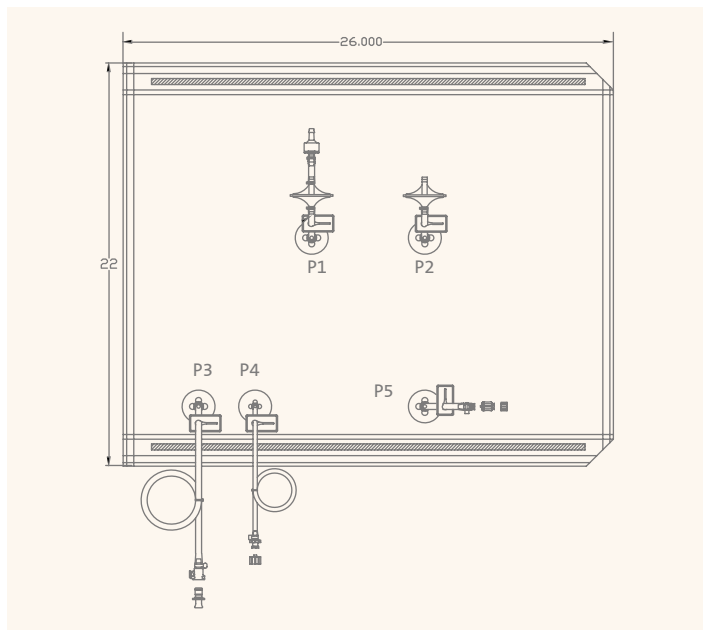

Cat. No.	Size	Qty/Pk
91-200-78	20L	1
	Check valve with 1/4" barb	
P1	PVDF 8004022 filter 2" length 3/16" I.D. x 3/8" O.D. PCMGs tube	
P2	PVDF 8004022 filter 2" length 3/16" I.D. x 3/8" O.D. PCMGs tube	
P3	Female MPC connector with 1/4" barb Male MPC plug 40" length 1/4" I.D. x 7/16" O.D. chemically resistant, heat sealable flexible tube	
P4	Female Luer with 1/4" barb Male Luer plug 40" length 1/8" I.D. x 1/4" O.D. chemically resistant, heat sealable flexible tube	
P5	Female Luer with 1/4" barb Swabbable valve Male Luer plug without stem	

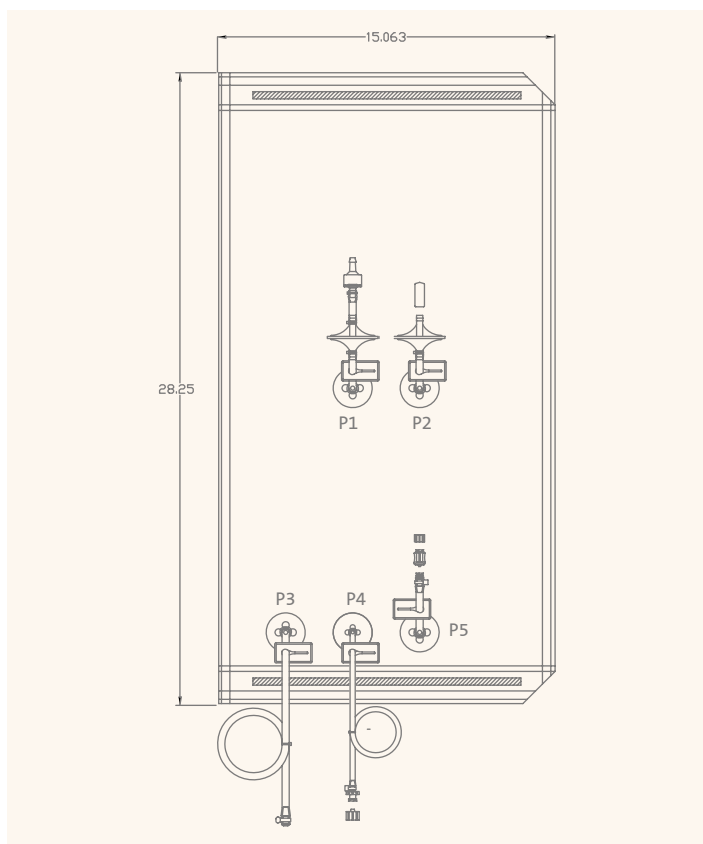

Cat. No.	Size	Qty/Pk
91-200-92	22L	1
	Check valve with 1/4" barb	
P1	PVDF 8004022 filter 2" length 3/16" I.D. x 3/8" O.D. PCMGs tube	
P2	PVDF 8004022 filter 2" length 3/16" I.D. x 3/8" O.D. PCMGs tube	
P3	Plug with 1/4" barb 48" length 1/4" I.D. x 7/16" O.D. chemically resistant, heat sealable flexible tube	
P4	Female Luer with 1/4" barb Male Luer plug 48" length 1/8" I.D. x 1/4" O.D. chemically resistant, heat sealable flexible tube	
P5	Female Luer with 1/4" barb Swabbable valve Male Luer plug without stem	

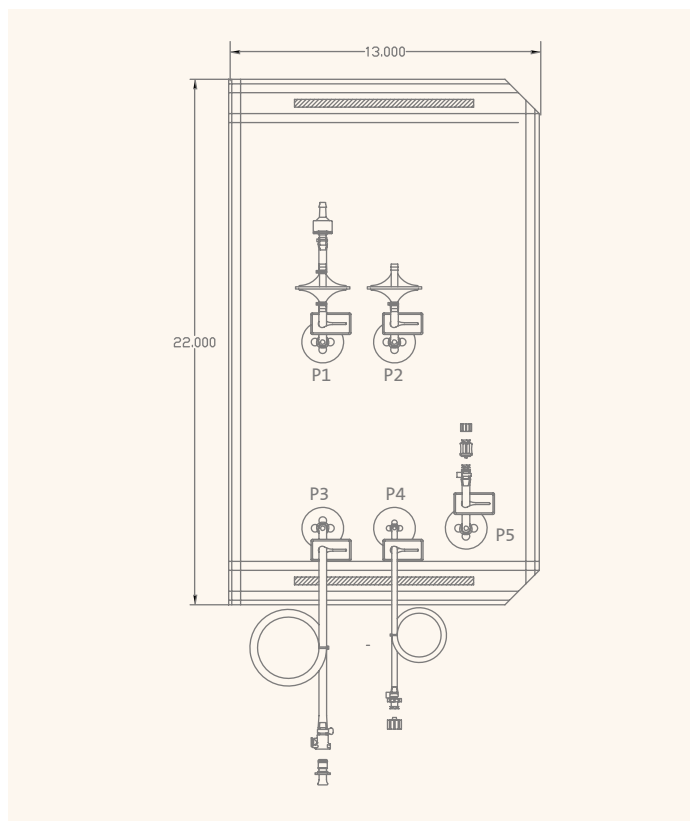

Cat. No.	Size	Qty/Pk
91-200-79	10L	1
P1	Check valve with 1/4" barb PVDF 8004022 filter 2" length 3/16" I.D. x 3/8" O.D. PCMGS tube	
P2	PVDF 8004022 filter 2" length 3/16" I.D. x 3/8" O.D. PCMGS tube	
P3	Female MPC connector with 1/4" barb and plug 40" length 1/4" I.D. x 7/16" O.D. chemically resistant, heat sealable flexible tube	
P4	Female Luer with 1/4" barb and plug 40" length 1/8" I.D. x 1/4" O.D. chemically resistant, heat sealable flexible tube	
P5	Female Luer with 1/4" barb Swabbable valve Male Luer plug without stem	

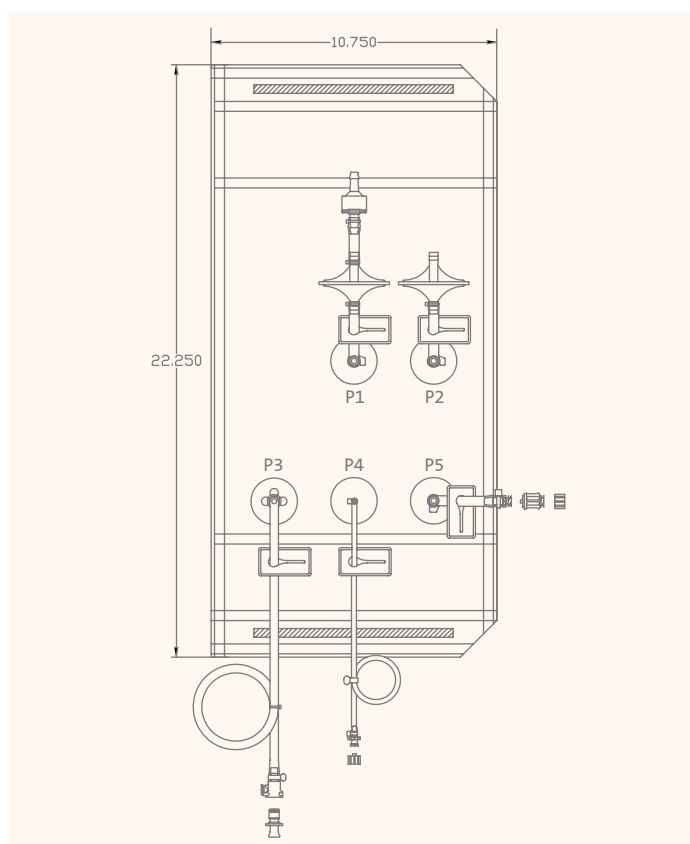

Cat. No.	Size	Qty/Pk
91-200-80	2L	1
P1	Check valve with 1/4" barb PVDF 8004022 filter 2" length 3/16" I.D. x 3/8" O.D. PCMGS tube	
P2	PVDF 8004022 filter 2" length 3/16" I.D. x 3/8" O.D. PCMGS tube	
P3	Female MPC connector with 1/4" barb Male MPC plug 40" length 1/4" I.D. x 7/16" O.D. chemically resistant, heat sealable flexible tube	
P4	Female Luer with 1/4" barb Male Luer plug 40" length 1/8" I.D. x 1/4" O.D. chemically resistant, heat sealable flexible tube	
P5	Female Luer with 1/4" barb Swabbable valve Male Luer plug without stem	

Media, Sera, Reagents,  
Flexible Bags

## ROCKER CELL CULTURE BAGS (CONTINUED)

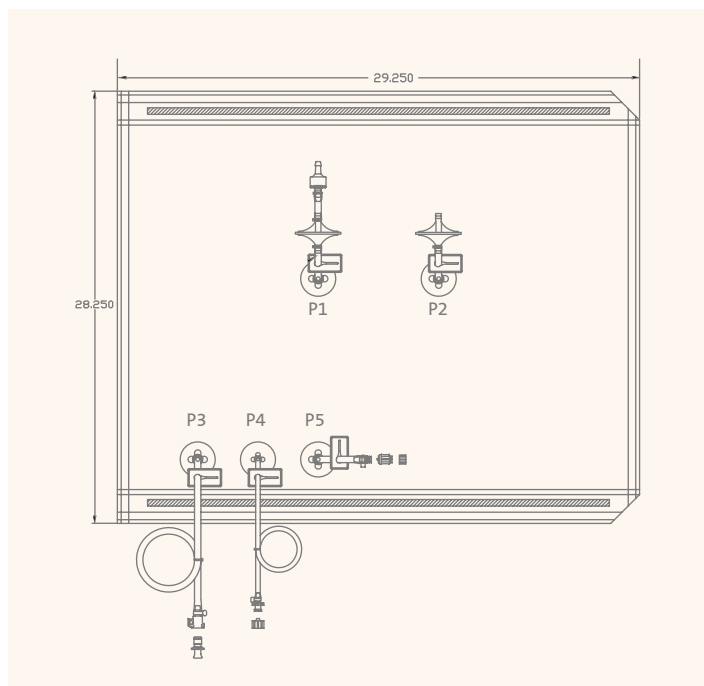

Cat. No.	Size	Qty/Pk
91-200-81	50L	1
P1	Check valve with 1/4" barb PVDF 8004022 filter 2" length 3/16" I.D. x 3/8" O.D. PCMGS tube	
P2	PVDF 8004022 filter 2" length 3/16" I.D. x 3/8" O.D. PCMGS tube	
P3	Female MPC connector with 1/4" barb Male MPC plug 40" length 1/4" I.D. x 7/16" O.D. chemically resistant, heat sealable flexible tubing	
P4	Female Luer with 1/4" barb Male Luer plug 40" length 1/8" I.D. x 1/4" O.D. chemically resistant, heat sealable flexible tubing	
P5	Female Luer with 1/4" barb Swabbable valve Male Luer plug without stem	

## TUBING SETS

Optional tubing sets are available in combination with all single-use bag options.

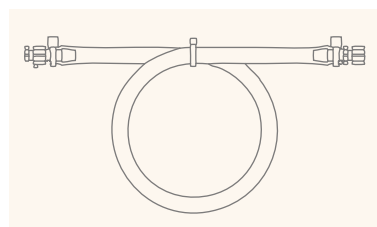

Cat. No.	Description	Qty/Pk
91-700-00	36" length 1/4" I.D. clear, chemically resistant, heat sealable, flexible tubing Male Luer and female Luer cap Female Luer and male Luer cap	1

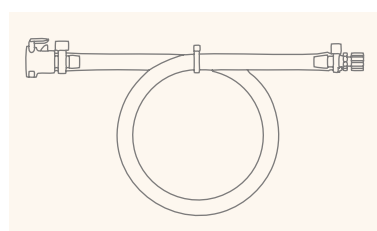

Cat. No.	Description	Qty/Pk
91-700-04	36" length 1/4" I.D. clear, chemically resistant, heat sealable, flexible tubing Female MPC connector Female Luer and male Luer cap	1

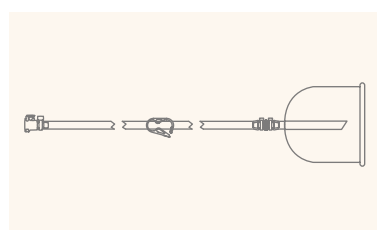

Cat. No.	Description	Qty/Pk
91-700-12	24" length 1/4" I.D. clear, chemically resistant, heat sealable, flexible tubing Female MPC connector with 1/4" barb Pinch clamp Filling bell	1

## SINGLE-USE BAGS FOR CORNING® HYPERSTACK® VESSELS

These single-use bags can be connected to tubing by tube welding or by using the pre-assembled multipurpose connectors. They can be used to add media, trypsin, or quenching substrates to culture cells in an entirely closed environment.

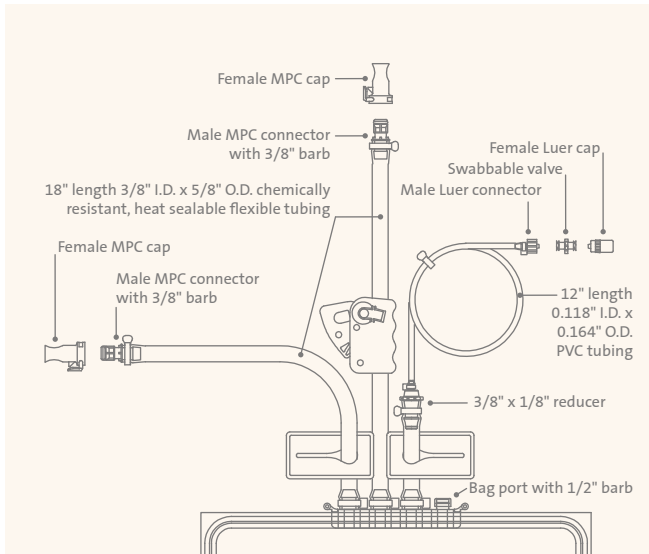

Cat. No.	Description	Film Type	Size	Qty/Pk
91-200-75	Trypsin bag	ULDPE	5L	1

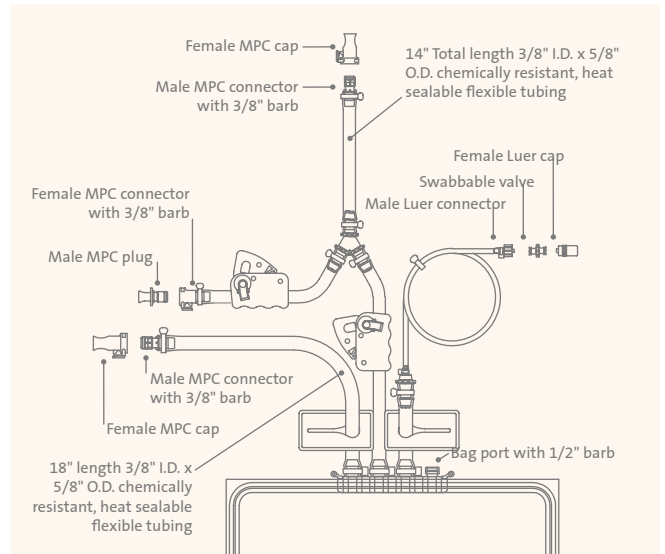

Cat. No.	Description	Film Type	Size	Qty/Pk
91-200-76	Quench bag	ULDPE	5L	1

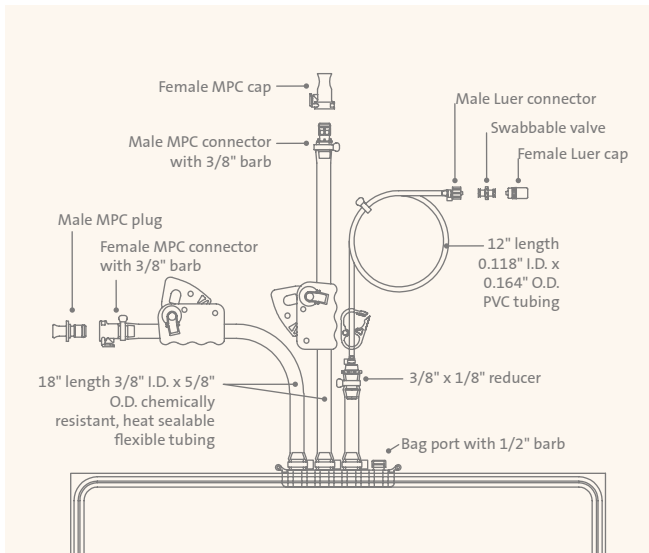

Cat. No.	Description	Film Type	Size	Qty/Pk
91-200-77	Media bag	ULDPE	20L	1



## TANK LINERS

Corning’s portfolio of sterile tank liners are designed to fit cylindrical tanks. Tank liners are manufactured with ultra-low density polyethylene (ULDPE) and are available in a range of sizes.

### Features and Benefits

- ▶ Sterile, individually packaged
- ▶ Animal-free components
- ▶ Reduce costs associated with the cleaning and validation of tanks
- ▶ Reduce labor costs and increase turnaround time
- ▶ Reduce the risks associated with cross contamination
- ▶ Help extend the life of reusable tanks, resulting in lower capital expenditures
- ▶ Wide variety of sizes available

### Gusseted Tank Liners (3D)

Cat. No.	Max. Volume	Diameter	Approx. Depth	Qty
91-300-15	50L	13"	27"	1
91-300-25	100L	18"	30"	1
91-300-35	200L	22"	36"	1

### Non-gusseted Tank Liners (2D)

Cat. No.	Max. Volume	Diameter	Approx. Depth	Qty
91-300-20	130L	18"	30"	1
91-300-30	200L	22.5"	36"	1
91-300-80	1090L	42"	49"	1

## FILM TYPES

### Ethyl Vinyl Acetate (EVA) Film

12.5 mil co-extrusion film—Collection bags.

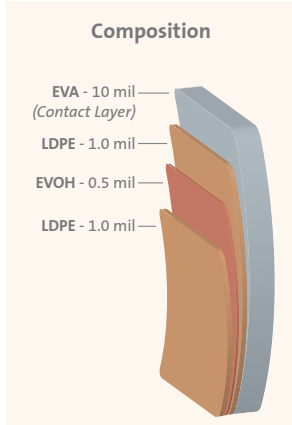

Biocompatibility Tests	Result	Test Protocol
USP intracutaneous reactivity test	Pass	USP <88>
USP acute systemic injection test	Pass	USP <88>
USP intramuscular implantation test	Pass	USP <88>
Toxicity	Nontoxic	USP <87>
Hemolysis	Non-hemolytic	ISO 10993-4
Bacterial endotoxin	<0.015 EU/mL	USP <85>

Physical Properties	Result	Test Protocol
H <sub>2</sub> O transmission (g/100 in <sup>2</sup> /24 hrs)	0.011	ASTM F-1249
CO <sub>2</sub> transmission (cm <sup>3</sup> /100 in <sup>2</sup> /24 hrs)	0.58	MOCON Test Method
O <sub>2</sub> transmission (cm <sup>3</sup> /100 in <sup>2</sup> /24 hrs)	0.28	ASTM F-3985
Ultimate tensile	3100 psi	ASTM D-638
Ultimate elongation	>650%	ASTM D-638
100% modulus	1000 psi	ASTM D-638
Tear strength	550 lbs/in	ASTM D-1004
Low pressure brittleness	>-75°F	ASTM D-1290
Puncture resistance	22.4 lbs	FTMS 101 B

### Metalocene Film

9.0 mil co-extruded blend of cross-linked polyethylene, EVOH, and Nylon—Collection bags.

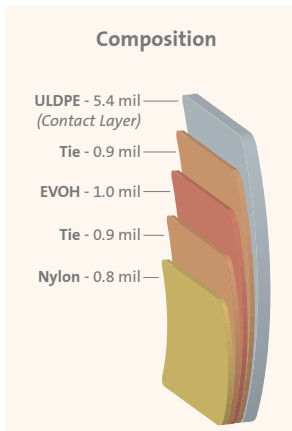

Biocompatibility Tests	Result	Test Protocol
Toxicity	Nontoxic	USP <87>
Bacterial endotoxin	<0.005 EU/mL	USP <85>
Hemolysis	Non-hemolytic	ISO 10993-4
Heavy metals	<1 ppm	ISO 3826-1; USP <661>
Buffering capacity	<1 mL	USP <661>
Non-volatile residue	<1 mg	USP <661>
Residue on ignition	<1 mg	ISO 3826-1; USP <661>
Appearance	Pass	--
Acidity and alkalinity	Pass	--
Absorbance	0.04 units	--
Oxidizable substance	<0.1 mL	--
Transparency	Pass	--

Physical Properties	Result	Test Protocol
H <sub>2</sub> O transmission (g/m <sup>2</sup> /24 hrs 23°C, 100% RH)	0.455	ASTM F-1249
CO <sub>2</sub> transmission (cm <sup>3</sup> /m <sup>2</sup> /24 hrs 23°C, 50% RH outside)	<1.0	ASTM F-2476
O <sub>2</sub> transmission rate (cm <sup>3</sup> /m <sup>2</sup> /24 hrs 23°C, 100% RH inside and 50% RH outside)	0.148	ASTM F-1927
Ultimate tensile strength	3094 psi	ASTM D-638
Elongation	416 (%)	ASTM D-638
Yield strength	1972 psi	--
Seam strength	18 pounds	--
Temperature range	-80°C to 60°C	--
Sterilization	SAL 10 <sup>-6</sup>	--

### Ultra-Low Density Polyethylene (ULDPE)/Ethylene Vinyl Acetate (EVA) Film

Single-ply multilayer structure with inert PE fluid contact layer. Film is animal-free—Rocker cell culture bags.

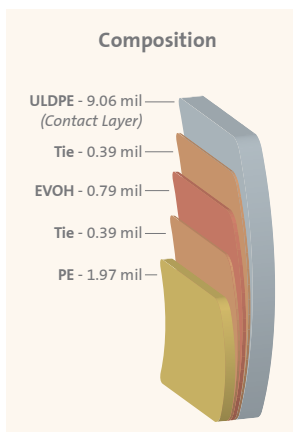

Physical Properties	Result	Test Protocol
Haze (%)	5	ASTM D-1003
Clarity (%)	98	ASTM D-1003
Transmittance (%)	93	ASTM D-1003
Tensile strength at break (Mpa)	14	ASTM D-882
Elongation at break (%)	280	ASTM D-882
Elastic modulus (Mpa)	370	ASTM D-882
Break at cold temperature (°C)	below -45°C	ISO 8570
Density (g/cm <sup>3</sup> )	0.9	ASTM D-792
H <sub>2</sub> O transmission rate g/m <sup>2</sup> /24 hrs	0.4 (23°C)	ASTM F-1249
O <sub>2</sub> permeability cm <sup>3</sup> /m <sup>2</sup> /24 hrs	0.1 (23°C, 0% RH)	ASTM D-3985
CO <sub>2</sub> permeability cm <sup>3</sup> /m <sup>2</sup> /24 hrs	<0.2 (23°C, 0% RH)	MOCON Permatran C-IV

### Ultra-Low Density Polyethylene (ULDPE) Film

Fluid contact layer is 5.0 mil, ultra-low density polyethylene. Outer film is 5-layer, 7 mil co-extrusion film—Bags for Corning® HYPERStack® vessels, collection bags.

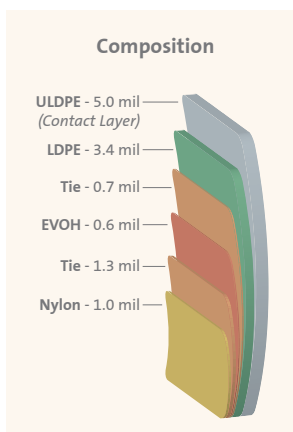

Biocompatibility Tests	Result	Test Protocol
USP intracutaneous reactivity test	Pass	USP <88>
USP acute systemic injection test	Pass	USP <88>
USP intramuscular implantation test	Pass	USP <88>
USP MEM elution method	Nontoxic	USP <87>
Physiochemical test for plastics	Pass	USP <661>

Physical Properties	Result	Test Protocol
H <sub>2</sub> O transmission (g/100 in <sup>2</sup> /24 hrs)	0.017	ASTM F-1249
CO <sub>2</sub> transmission (cm <sup>3</sup> /100 in <sup>2</sup> /24 hrs)	0.129	ASTM F-2476
O <sub>2</sub> transmission (cm <sup>3</sup> /100 in <sup>2</sup> /24 hrs)	0.043	ASTM F-1927

	Average Force	Average MOE	Average Elongation	Test Protocol
Tensile strength	32.73 lbs	25110 psi	1080%	ASTM D 882-02
	Min Force	Average Force	Max Force	
Tear resistance	6.77 lbs	7.21 lbs	7.74 lbs	ASTM D1004-07
Puncture resistance	16.42 lbs	18.61 lbs	19.51 lbs	FTMS 101C

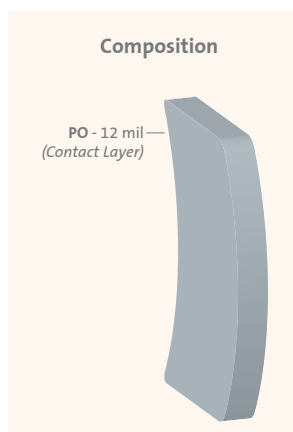

### Polyolefin (PO) Film

Single-web, 12 mil polyolefin monolayer designed for extremely low temperatures—Cell expansion bags.

Biocompatibility Tests	Result	Test Protocol
USP Class VI	Pass	USP <88>
Toxicity	Nontoxic	USP <87>
Hemolysis	Non-hemolytic	ISO 10993-4
Heavy metals	Pass	ISO 3826-1; USP <661>
Buffering capacity	Pass	USP <661>
Non-volatile residue	Pass	USP <661>
Residue on ignition	Pass	ISO 3826-1; USP <661>
Local effects after implantation	Pass	ISO 10993-6
Irritation and delayed-type sensitivity	Pass	ISO 10993-10
Systemic toxicity	Pass	ISO 10993-11
Bacterial endotoxin	<20 EU/device	USP <85>

Physical Properties	Result	Test Protocol
H <sub>2</sub> O transmission g/100 in <sup>2</sup> /24 hrs at 25°C	1.1	ASTM F1249
CO <sub>2</sub> transmission cm <sup>3</sup> /100 in <sup>2</sup> /24 hrs at 25°C, 0% RH	1477	ASTM F2476
O <sub>2</sub> transmission cm <sup>3</sup> /100 in <sup>2</sup> /24 hrs at 25°C, 0% RH	180	ASTM D3985
Tensile strength (Mpa)	17	ASTM D882
Elongation at break, MD/TD (%)	560/700	ASTM D882
Elastic modulus (Mpa)	17	ASTM D882
Break at cold temperature (°C)	Below -80°C	ISO 8570
Glass transition temperature (Tg)	-48°C	DSC
Density (g/cm <sup>3</sup> )	0.92	ASTM D792
Low temperature, (remains flexible)	-196°C	--

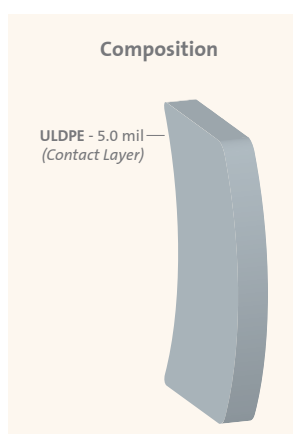

### Tank Liner Film

Biocompatibility Tests	Result	Test Protocol
USP intracutaneous reactivity	Pass	USP <88>
USP acute systemic injection	Pass	USP <88>
USP intramuscular implantation	Pass	USP <88>
Toxicity	Nontoxic	USP <87>
Physiochemical test for plastics	Pass	USP <661>

Physical Properties	Result	Test Protocol
H <sub>2</sub> O transmission (g/100 in <sup>2</sup> /24 hrs)	0.017	ASTM F-1249
CO <sub>2</sub> transmission (cm <sup>3</sup> /100 in <sup>2</sup> /24 hrs)	0.129	ASTM F-2476
O <sub>2</sub> transmission (cm <sup>3</sup> /100 in <sup>2</sup> /24 hrs)	0.043	ASTM F-1927

	Average MOE	Average Elongation	Test Protocol
Tensile strength	5756 psi	710%	ASTM D 882
	Average Force		
Impact strength	2.52 lbs	7.74 lbs	ASTM D 1709



# Formulations

AMEM (Alpha Modification of Eagle's Medium).....	H54
Antibiotic-Antimycotic Solution.....	H54
Buffered Saline Solutions.....	H55
CMRL 1066.....	H55
DMEM (Dulbecco's Modification of Eagle's Medium).....	H56-H57
DMEM/Ham's F-12 50/50 Mix.....	H58
DMEM with Corning® glutagro™ Supplement.....	H58
F-12K Nutrient Mixture (Kaighn's Modification).....	H59
Corning glutagro Supplement and L-glutamine.....	H59
Grace's Insect Basal Medium/Hink's TNM-FH Medium.....	H60
Ham's F-10 Medium.....	H61
Ham's F-12 Medium.....	H62
HAT/HT.....	H62
HEPES.....	H62
HBSS (Hank's Balanced Salt Solutions).....	H63
Improved MEM.....	H63
IMDM (Iscove's Modification of DMEM).....	H64
ITS (Insulin, Transferrin, and Selenium Solution).....	H64
LSM (Lymphocyte Separation Medium).....	H64
Leibovitz's L-15.....	H65
McCoy's 5A Medium (Iwakata and Grace Modification).....	H65
MCDB 131.....	H66
M199 (Medium 199).....	H67
MEM (Minimum Essential Medium) Amino Acids Solution.....	H68
MEM Vitamin Solution.....	H68
NEAA (MEM Non-essential Amino Acids Solution).....	H68
Microbiological Media.....	H69
Molecular Biology Buffers.....	H69
MEM.....	H70
Penicillin Streptomycin Solutions.....	H71
Trace Elements.....	H71
Trypsin and Trypsin/EDTA Solutions.....	H72
TSB (Tryptic Soy Broth).....	H72
Trypan Blue.....	H72
RPMI 1640.....	H73-H74

### AMEM (Alpha Modification of Eagle's Medium)

Cat. No.	10-022	15-012	50-012
Description	Liquid, 1x	Liquid, 1x	Powder
Units	mg/L	mg/L	mg/L

Components			
<i>Inorganic Salts</i>			
CaCl <sub>2</sub> (anhydrous)	200.00	200.00	200.00
KCl	400.00	400.00	400.00
MgSO <sub>4</sub> (anhydrous)	97.70	97.70	97.70
NaCl	6,800.00	6,800.00	6,800.00
NaH <sub>2</sub> PO <sub>4</sub> • H <sub>2</sub> O	140.00	140.00	140.00
NaHCO <sub>3</sub>	2,200.00	2,200.00	--
<i>Amino Acids</i>			
L-Alanine	25.00	25.00	25.00
L-Arginine • HCl	126.40	126.40	126.40
L-Asparagine • H <sub>2</sub> O	50.00	50.00	50.00
L-Aspartic acid	30.00	30.00	30.00
L-Cysteine • HCl • H <sub>2</sub> O	100.00	100.00	100.00
L-Cystine • 2HCl	31.20	31.20	31.20
L-Glutamic acid	75.00	75.00	75.00
L-glutamine	292.00	--	292.00
Glycine	50.00	50.00	50.00
L-Histidine • HCl • H <sub>2</sub> O	41.90	41.90	41.90
L-Isoleucine	52.50	52.50	52.50
L-Leucine	52.50	52.50	52.50
L-Lysine • HCl	72.50	72.50	72.50
L-Methionine	15.00	15.00	15.00
L-Phenylalanine	32.50	32.50	32.50
L-Proline	40.00	40.00	40.00
L-Serine	25.00	25.00	25.00
L-Threonine	47.60	47.60	47.60
L-Tryptophan	10.00	10.00	10.00
L-Tyrosine • 2Na • 2H <sub>2</sub> O	51.90	51.90	51.90
L-Valine	46.80	46.80	46.80
<i>Vitamins</i>			
Ascorbic acid	50.00	50.00	50.00
Biotin	0.10	0.10	0.10
D-Calcium pantothenate	1.00	1.00	1.00
Choline chloride	1.00	1.00	1.00
Folic acid	1.00	1.00	1.00
<i>i</i> -Inositol	2.00	2.00	2.00
Nicotinamide	1.00	1.00	1.00
Pyridoxine • HCl	1.00	1.00	1.00
Riboflavin	0.10	0.10	0.10
Thiamine • HCl	1.00	1.00	1.00
Vitamin B12	1.36	1.36	1.36

Cat. No.	10-022	15-012	50-012
Description	Liquid, 1x	Liquid, 1x	Powder
Units	mg/L	mg/L	mg/L

Other			
D-Glucose	1,000.00	1,000.00	1,000.00
Lipoic acid	0.20	0.20	0.20
Phenol red • Na	10.00	10.00	10.00
Sodium pyruvate	110.00	110.00	110.00
<i>Nucleosides</i>			
Thymidine	10.00	--	--
Adenosine	10.00	--	--
Cytidine	10.00	--	--
Guanosine	10.00	--	--
Uridine (anhydrous)	10.00	--	--
2'-Deoxyadenosine • H <sub>2</sub> O	10.00	--	--
2'-Deoxycytidine • HCl	11.00	--	--
2'-Deoxyguanosine • H <sub>2</sub> O	10.00	--	--

Add			
NaHCO <sub>3</sub> Powder (g/L)	--	--	2.20
7.5% Solution (mL/L)	--	--	29.33
L-glutamine Powder (mg/L)	--	292.00	292.00
200 mM Solution (mL/L)	--	10.00	10.00

### Antibiotic-Antimycotic Solution

Cat. No.	30-003	30-004	30-005
Description	Liquid	Liquid, 100x	Liquid
Units	g/L	U/L and mg/L	g/L

Components			
K Penicillin G	--	10,000,000 U/L	--
Dihydro-streptomycin • SO <sub>4</sub>	--	0.01 mg/L (adjusted for potency)	--
Amphotericin B (solubilized w/sodium deoxycholate and sodium phosphate)	0.25	0.000025 mg/L (adjusted for potency)	--
NaCl	--	0.0085 mg/L	--
Gentamycin Sulfate	--	--	50

"--" indicates not present

### Buffered Saline Solutions

Cat. No.	20-030	20-031	21-030	21-031	21-040	46-012	46-013	55-031
Description	Liquid, 10x	Liquid, 10x	Liquid, 1x	Liquid, 1x	Liquid, 1x	Liquid, 10x	Liquid, 10x	Powder
Units	g/L	g/L	g/L	g/L	g/L	g/L	g/L	g/L

Components								
Inorganic Salts								
CaCl <sub>2</sub> (anhydrous)	1.00	--	0.10	--	--	--	--	--
KCl	2.00	2.00	0.20	0.20	--	--	2.0	0.20
KH <sub>2</sub> PO <sub>4</sub>	2.00	2.00	0.20	0.20	0.144	--	2.40	0.20
MgCl <sub>2</sub> • 6H <sub>2</sub> O	1.00	--	0.10	--	--	--	--	--
NaCl	80.00	80.00	8.00	8.00	9.00	80.00	80.00	8.00
Na <sub>2</sub> HPO <sub>4</sub> (anhydrous)	11.50	11.50	--	1.15	0.795	--	14.40	1.15
Na <sub>2</sub> HPO <sub>4</sub> • 7H <sub>2</sub> O	--	--	2.1716	--	--	--	--	--
Organic Buffers								
Tris Ultrapure	--	--	--	--	--	24.2	--	--

### CMRL 1066

Cat. No.	15-110
Description	Liquid, 1x
Units	mg/L

Components	
Inorganic Salts	
CaCl <sub>2</sub> (anhydrous)	200
KCl	400
MgSO <sub>4</sub> (anhydrous)	97.70
NaCl	6,800
NaH <sub>2</sub> PO <sub>4</sub> • H <sub>2</sub> O	140
NaHCO <sub>3</sub>	2,200
Amino Acids	
L-Alanine	25
L-Arginine • HCl	70
L-Aspartic acid	30
L-Cysteine • HCl • H <sub>2</sub> O	260
L-Cystine • 2HCl	26
L-Glutamic acid	75
Glycine	50
L-Histidine • HCl • H <sub>2</sub> O	20
Hydroxy-L-proline	10
L-Isoleucine	20
L-Leucine	60
L-Lysine • HCl	70
L-Methionine	15
L-Phenylalanine	25
L-Proline	40
L-Serine	25
L-Threonine	30
L-Tryptophan	10
L-Tyrosine • 2Na • 2H <sub>2</sub> O	58
L-Valine	25

Vitamins	
Biotin	0.01
Folic acid	0.01
Riboflavin	0.01
Ascorbic acid	50.00
D-Ca-Pantothenate	0.01
Choline Chloride	0.50
<i>i</i> -Inositol	0.05
Nicotinic acid	0.025
Nicotinamide	0.025
PABA	0.05
Pyridoxine • HCl	0.05
Thiamine • HCl	0.01
Thiamine pyrophosphate, Na	1.00
Other	
Thymidine	10.00
2'-Deoxyadenosine • H <sub>2</sub> O	10.00
2'-Deoxycytidine • HCl	10.00
2'-Deoxyguanosine • H <sub>2</sub> O	10.00
5-Methyl-2'-deoxycytidine	0.10
Uridine-5'-triphosphate • 3Na • hydrate	1.00
Cholesterol	0.20
Polysorbate 80	5.00
Coenzyme A Li <sub>3</sub> salt • 2H <sub>2</sub> O	2.50
b-NAD • hydrate	7.00
b-NADP • Na • 4H <sub>2</sub> O	1.00
FAD disodium salt	1.00
Dextrose	1000
Glutathione (reduced)	10.00
Sodium acetate	50.00
Sodium glucuronate • H <sub>2</sub> O	4.20
Add	
L-glutamine Powder (mg/L)	100.00
200 mM Solution (mL/L)	3.42

"--" indicates not present



**DMEM (Dulbecco's Modification of Eagle's Medium)**

Cat. No.	10-013	10-014	10-017	10-101	10-102	15-013	15-017	15-018	17-204
Description	Liquid, 1x	Liquid, 1x	Liquid, 1x	Liquid, 1x	Liquid, 1x	Liquid, 1x	Liquid, 1x	Liquid, 1x	Liquid, 1x
Units	mg/L	mg/L	mg/L	mg/L	mg/L	mg/L	mg/L	mg/L	mg/L

Components									
<i>Inorganic Salts</i>									
CaCl <sub>2</sub> (anhydrous)	200	200	200	200	200	200	200	200	200
Fe(NO <sub>3</sub> ) <sub>3</sub> • 9H <sub>2</sub> O	0.1	0.1	0.1	0.1	0.1	0.1	0.1	0.1	0.1
KCl	400	400	400	400	400	400	400	400	400
MgSO <sub>4</sub> (anhydrous)	97.7	97.7	97.7	97.7	97.7	97.7	97.7	97.7	97.7
NaCl	6,400	6,400	6,400	6,400	6,400	6,400	6,400	6,400	6,400
NaH <sub>2</sub> PO <sub>4</sub> • H <sub>2</sub> O	125	125	125	125	125	125	125	125	125
NaHCO <sub>3</sub>	3,700	3,700	3,700	3,700	3,700	3,700	3,700	3,700	3,700
<i>Amino Acids</i>									
L-Arginine • HCl	84	84	84	84	84	84	84	84.00	84.00
L-Cystine • 2HCl	62.57	62.57	62.57	62.57	62.57	62.57	62.57	62.57	--
L-Alanyl-L-glutamine	--	--	--	869	869	--	--	--	--
L-glutamine	584	584	584	--	--	--	--	--	--
Glycine	30	30	30	30	30	30	30	30.00	30.00
L-Histidine • HCl • H <sub>2</sub> O	42	42	42	42	42	42	42	42.00	42.00
L-Isoleucine	104.8	104.8	104.8	104.8	104.8	104.8	104.8	104.80	104.80
L-Leucine	104.8	104.8	104.8	104.8	104.8	104.8	104.8	104.80	104.80
L-Lysine • HCl	146.2	146.2	146.2	146.2	146.2	146.2	146.2	146.20	146.20
L-Methionine	30	30	30	30	30	30	30	30.00	--
L-Phenylalanine	66	66	66	66	66	66	66	66.00	66.00
L-Serine	42	42	42	42	42	42	42	42.00	42.00
L-Threonine	95.2	95.2	95.2	95.2	95.2	95.2	95.2	95.20	95.20
L-Tryptophan	16	16	16	16	16	16	16	16.00	16.00
L-Tyrosine • 2Na • 2H <sub>2</sub> O	103.79	103.79	103.79	103.79	103.79	103.79	103.79	103.79	103.79
L-Valine	94	94	94	94	94	94	94	94.00	94.00
<i>Vitamins</i>									
D-Calcium pantothenate	4.00	4.00	4.00	4.00	4.00	4.00	4.00	4.00	4.00
Choline chloride	4.00	4.00	4.00	4.00	4.00	4.00	4.00	4.00	4.00
Folic acid	4.00	4.00	4.00	4.00	4.00	4.00	4.00	4.00	4.00
<i>i</i> -Inositol	7.20	7.20	7.20	7.20	7.20	7.20	7.20	7.20	7.20
Nicotinamide	4.00	4.00	4.00	4.00	4.00	4.00	4.00	4.00	4.00
Pyridoxine • HCl	4.00	4.00	4.00	4.00	4.00	4.00	4.00	4.00	4.00
Riboflavin	0.40	0.40	0.40	0.40	0.40	0.40	0.40	0.40	0.40
Thiamine • HCl	4.00	4.00	4.00	4.00	4.00	4.00	4.00	4.00	4.00
<i>Other</i>									
D-Glucose	4,500.00	1,000.00	4,500.00	4,500.00	4,500.00	4,500.00	4,500.00	4,500.00	4,500.00
Phenol red • Na	15.00	15.00	15.00	15.00	15.00	15.00	15.00	15.00	15.00
Sodium pyruvate	110.00	110.00	--	110.00	--	110.00	--	110.00	110.00
HEPES	--	--	--	--	--	--	--	5,958.00	--
<b>Add</b>									
L-glutamine Powder (mg/L)	--	--	--	--	--	584.00	584.00	584.00	584.00
200 mM Solution (mL/L)	--	--	--	--	--	20.00	20.00	20.00	20.00

"--" indicates not present

Media, Sera, Reagents,  
Flexible Bags

### DMEM (Dulbecco's Modification of Eagle's Medium)

Cat. No.	17-205	17-206	17-207	50-003	50-013	90-013	90-113
Description	Liquid, 1x	Liquid, 1x	Liquid, 1x	Powder	Powder	Powder	Powder
Units	mg/L	mg/L	mg/L	mg/L	mg/L	mg/L	mg/L
<b>Components</b>							
<i>Inorganic Salts</i>							
CaCl <sub>2</sub> (anhydrous)	200.00	200.00	200.00	200.00	200.00	200.00	200.00
Fe(NO <sub>3</sub> ) <sub>3</sub> • 9H <sub>2</sub> O	0.10	0.10	0.10	0.10	0.10	0.10	0.10
KCl	400.00	400.00	400.00	400.00	400.00	400.00	400.00
MgSO <sub>4</sub> (anhydrous)	97.70	97.70	97.70	97.70	97.70	97.70	97.70
NaCl	6,400.00	6,400.00	6,400.00	6,400.00	6,400.00	6,400.00	6,400.00
NaH <sub>2</sub> PO <sub>4</sub> • H <sub>2</sub> O	125.00	--	125.00	125.00	125.00	125.00	125.00
NaHCO <sub>3</sub>	3,700.00	3,700.00	3,700.00	--	--	--	--
<i>Amino Acids</i>							
L-Arginine • HCl	84.00	84.00	84.00	84.00	84.00	84.00	84.00
L-Cystine • 2HCl	62.57	62.57	62.57	62.57	62.57	62.57	62.57
L-glutamine	--	--	--	584.00	584.00	--	--
Glycine	30.00	30.00	30.00	30.00	30.00	30.00	30.00
L-Histidine • HCl • H <sub>2</sub> O	42.00	42.00	42.00	42.00	42.00	42.00	42.00
L-Isoleucine	104.80	104.80	104.80	104.80	104.80	104.80	104.80
L-Leucine	104.80	104.80	104.80	104.80	104.80	104.80	104.80
L-Lysine • HCl	146.20	146.20	146.20	146.20	146.20	146.20	146.20
L-Methionine	30.00	30.00	30.00	30.00	30.00	30.00	30.00
L-Phenylalanine	66.00	66.00	66.00	66.00	66.00	66.00	66.00
L-Serine	42.00	42.00	42.00	42.00	42.00	42.00	42.00
L-Threonine	95.20	95.20	95.20	95.20	95.20	95.20	95.20
L-Tryptophan	16.00	16.00	16.00	16.00	16.00	16.00	16.00
L-Tyrosine • 2Na • 2H <sub>2</sub> O	103.79	103.79	103.79	103.79	103.79	103.79	103.79
L-Valine	94.00	94.00	94.00	94.00	94.00	94.00	94.00
<i>Vitamins</i>							
D-Calcium pantothenate	4.00	4.00	4.00	4.00	4.00	4.00	4.00
Choline chloride	4.00	4.00	4.00	4.00	4.00	4.00	4.00
Folic acid	4.00	4.00	4.00	4.00	4.00	4.00	4.00
<i>i</i> -Inositol	7.20	7.20	7.20	7.20	7.20	7.20	7.20
Nicotinamide	4.00	4.00	4.00	4.00	4.00	4.00	4.00
Pyridoxine • HCl	4.00	4.00	4.00	4.00	4.00	4.00	4.00
Riboflavin	0.40	0.40	0.40	0.40	0.40	0.40	0.40
Thiamine • HCl	4.00	4.00	4.00	4.00	4.00	4.00	4.00
<i>Other</i>							
D-Glucose	4,500.00	4,500.00	--	4,500.00	4,500.00	4,500.00	--
Phenol red • Na	--	15.00	15.00	15.00	15.00	--	--
Sodium pyruvate	110.00	110.00	--	110.00	--	--	--
HEPES	--	--	--	--	--	--	--
<b>Add</b>							
NaHCO <sub>3</sub> Powder (g/L)	--	--	--	3.70	3.70	--	3.70
7.5% Solution (mL/L)	--	--	--	49.40	49.40	--	49.40
L-glutamine Powder (mg/L)	584.00	584.00	584.00	--	--	--	584.00
200 mM Solution (mL/L)	20.00	20.00	20.00	--	--	--	20.00

"--" indicates not present

Media, Sera, Reagents,  
Flexible Bags

**DMEM/Ham's F-12 50/50 Mix**

Cat. No.	10-090	10-092	10-103	16-405	90-090	90-091
Description	Liquid, 1x	Liquid, 1x	Liquid, 1x	Liquid, 1x	Powder	Powder
Units	mg/L	mg/L	mg/L	mg/L	mg/L	mg/L

Components						
Inorganic Salts						
CaCl <sub>2</sub> (anhydrous)	116.65	116.65	116.65	116.65	116.65	116.65
FeSO <sub>4</sub> • 7H <sub>2</sub> O	0.417	0.417	0.417	0.417	0.417	0.417
Fe(NO <sub>3</sub> ) <sub>3</sub> • 9H <sub>2</sub> O	0.05	0.05	0.05	0.05	0.05	0.05
KCl	311.8	311.8	311.8	311.8	311.8	311.8
CuSO <sub>4</sub> (anhydrous)	0.0008	0.0008	0.0008	0.0008	0.0008	0.0008
MgSO <sub>4</sub> (anhydrous)	84.95	84.95	84.95	84.95	84.95	84.95
NaCl	7,000	7,000	7,000	7,000	7,000	7,000
NaH <sub>2</sub> PO <sub>4</sub> • H <sub>2</sub> O	62.5	62.5	62.5	62.5	62.5	62.5
Na <sub>2</sub> HPO <sub>4</sub> (anhydrous)	71	71	71	71	71	71
NaHCO <sub>3</sub>	2,438	2,438	2,438	2,438	--	--
ZnSO <sub>4</sub> • 7H <sub>2</sub> O	0.4315	0.4315	0.4315	0.4315	0.4315	0.4315
Amino Acids						
L-Alanine	4.45	4.45	4.45	4.45	4.45	4.45
L-Arginine • HCl	147.5	147.5	147.5	147.5	147.5	147.5
L-Asparagine • H <sub>2</sub> O	7.5	7.5	7.5	7.5	7.5	7.5
L-Aspartic acid	6.65	6.65	6.65	6.65	6.65	6.65
L-Cysteine • HCl • H <sub>2</sub> O	17.56	17.56	17.56	17.56	17.56	17.56
L-Cystine • 2HCl	31.285	31.285	31.285	31.285	31.285	31.285
L-Glutamic acid	7.35	7.35	7.35	7.35	7.35	7.35
L-Alanyl-L-glutamine	--	--	543	--	--	--
L-glutamine	365.1	365.1	--	365.1	--	365.1
Glycine	18.75	18.75	18.75	18.75	18.75	18.75
L-Histidine • HCl • H <sub>2</sub> O	31.48	31.48	31.48	31.48	31.48	31.48
L-Isoleucine	54.37	54.37	54.37	54.37	54.37	54.37
L-Leucine	58.95	58.95	58.95	58.95	58.95	58.95
L-Lysine • HCl	91.35	91.35	91.35	91.35	91.35	91.35
L-Methionine	17.24	17.24	17.24	17.24	17.24	17.24
L-Phenylalanine	35.48	35.48	35.48	35.48	35.48	35.48
L-Proline	17.25	17.25	17.25	17.25	17.25	17.25
L-Serine	26.25	26.25	26.25	26.25	26.25	26.25
L-Threonine	53.55	53.55	53.55	53.55	53.55	53.55
L-Tryptophan	9.02	9.02	9.02	9.02	9.02	9.02
L-Tyrosine • 2Na • 2H <sub>2</sub> O	55.815	55.815	55.815	55.815	55.815	55.815
L-Valine	52.85	52.85	52.85	52.85	52.85	52.85
Vitamins						
Biotin	0.00365	0.00365	0.00365	0.00365	0.00365	0.00365
D-Ca-Pantothenate	2.24	2.24	2.24	2.24	2.24	2.24
Choline chloride	8.98	8.98	8.98	8.98	8.98	8.98
Folic acid	2.65	2.65	2.65	2.65	2.65	2.65
<i>D</i> -Inositol	12.61	12.61	12.61	12.61	12.61	12.61
Nicotinamide	2.0185	2.0185	2.0185	2.0185	2.0185	2.0185
Pyridoxine • HCl	2.031	2.031	2.031	2.031	2.031	2.031
Riboflavin	0.219	0.219	0.219	0.219	0.219	0.219
Thiamine • HCl	2.17	2.17	2.17	2.17	2.17	2.17

Cat. No.	10-090	10-092	10-103	16-405	90-090	90-091
Description	Liquid, 1x	Liquid, 1x	Liquid, 1x	Liquid, 1x	Powder	Powder
Units	mg/L	mg/L	mg/L	mg/L	mg/L	mg/L

Other						
Dextrose	3,151	3,151	3,151	3,151	3,151	3,151
Hypoxanthine, sodium	2.385	2.385	2.385	2.385	2.385	2.385
DL-Thioctic (lipoic) acid	0.105	0.105	0.105	0.105	0.105	0.105
Methyl lineoleate	0.044	0.044	0.044	0.044	0.044	0.044
Phenol red, sodium	8.1	8.1	8.1	--	--	8.1
Putrescine*2HCl	0.08	0.08	0.08	0.08	0.08	0.08
Sodium pyruvate	110	110	110	110	110	110
Thymidine	0.365	0.365	0.365	0.365	0.365	0.365
HEPES	--	3574.8	--	--	--	--

Add						
NaHCO <sub>3</sub> Powder (g/L)	--	--	--	--	2,438	2,438
7.5% Solution (mL/L)	--	--	--	--	32.50	32.50
L-glutamine Powder (mg/L)	--	--	--	--	365.10	365.10
200 mM Solution (mL/L)	--	--	--	--	12.50	12.50

"--" indicates not present

Media, Sera, Reagents,  
Flexible Bags

### F-12K Nutrient Mixture (Kaighn's Modification)

<b>Cat. No.</b>	10-025
<b>Description</b>	Liquid, 1x
<b>Units</b>	mg/L

Components	
<i>Inorganic Salts</i>	
CaCl <sub>2</sub> (anhydrous)	102.00
CuSO <sub>4</sub> • 5H <sub>2</sub> O	0.002
Fe(NO <sub>3</sub> ) <sub>3</sub> • 9H <sub>2</sub> O	--
FeSO <sub>4</sub> • 7H <sub>2</sub> O	0.800
KCl	285.00
KH <sub>2</sub> PO <sub>4</sub>	59.00
MgCl <sub>2</sub> (anhydrous)	49.70
MgSO <sub>4</sub> (anhydrous)	192.00
NaCl	7,530.00
NaH <sub>2</sub> PO <sub>4</sub> (anhydrous)	--
Na <sub>2</sub> HPO <sub>4</sub> (anhydrous)	115.50
NaHCO <sub>3</sub>	2,500.00
ZnSO <sub>4</sub> • 7H <sub>2</sub> O	0.144
<i>Amino Acids</i>	
L-Alanine	18.00
L-Arginine • HCl	422.00
L-Asparagine • H <sub>2</sub> O	30.00
L-Aspartic acid	26.60
L-Cysteine • HCl • H <sub>2</sub> O	70.00
L-Cystine • 2HCl	--
L-Glutamic acid	29.00
L-glutamine	292.00
Glycine	15.00
L-Histidine • HCl • H <sub>2</sub> O	45.80
L-Isoleucine	7.88
L-Leucine	26.20
L-Lysine • HCl	73.00
L-Methionine	8.96
L-Phenylalanine	9.92
L-Proline	69.00
L-Serine	21.00
L-Threonine	23.00
L-Tryptophan	4.10
L-Tyrosine • 2Na • 2H <sub>2</sub> O	13.50
L-Valine	23.00

<b>Cat. No.</b>	10-025
<b>Description</b>	Liquid, 1x
<b>Units</b>	mg/L

Vitamins	
Biotin	0.070
D-Calcium pantothenate	0.50
Choline chloride	14.00
Folic acid	1.30
<i>i</i> -Inositol	18.00
Nicotinamide	0.037
Pyridoxine • HCl	0.060
Riboflavin	0.040
Thiamine • HCl	0.30
Vitamin B <sub>12</sub>	1.40
<i>Other</i>	
D-Glucose	1,260.00
HEPES	--
Hypoxanthine, Na	4.00
Lipoic acid	0.21
Methyl lineoleate	--
Phenol red • Na	3.00
Putrescine • 2HCl	0.32
Sodium pyruvate	220.00
Thymidine	0.70

### Corning® glutagro™ Supplement and L-glutamine

<b>Cat. No.</b>	25-015	25-005
<b>Description</b>	Liquid, 100x	Liquid, 100x
<b>Units</b>	g/L	g/L

Components		
L-Alanyl-L-glutamine	43.44	--
L-glutamine	--	29.20
NaCl	8.5	8.5

"--" indicates not present

**Grace's Insect Basal Medium (Vaughn Modification) / Hink's TNM-FH Medium (Supplemented Grace's Medium)**

Cat. No.	13-100	13-200
Description	Liquid, 1x	Liquid, 1x
Units	mg/L	mg/L

Components		
<i>Inorganic Salts</i>		
CaCl <sub>2</sub> (anhydrous)	750.00	750.00
KCl	2,220.00	3,720.00
MgCl <sub>2</sub> (anhydrous)	1,068.00	1,068.00
MgSO <sub>4</sub> (anhydrous)	1,358.00	1,358.00
NaH <sub>2</sub> PO <sub>4</sub> • H <sub>2</sub> O	1,008.00	1,008.00
NaHCO <sub>3</sub>	350.00	350.00
<i>Amino Acids</i>		
β-Alanine	200.00	200.00
L-Alanine	225.00	225.00
L-Arginine • HCl	700.00	700.00
L-Asparagine • H <sub>2</sub> O	350.00	350.00
L-Aspartic acid	350.00	350.00
L-Cystine • 2HCl	25.00	25.00
L-Glutamic acid	600.00	600.00
L-glutamine	600.00	600.00
Glycine	650.00	650.00
L-Histidine	2,500.00	2,500.00
L-Isoleucine	50.00	50.00
L-Leucine	75.00	75.00
L-Lysine • HCl	625.00	625.00
L-Methionine	50.00	50.00
L-Phenylalanine	150.00	150.00
L-Proline	350.00	350.00
DL-Serine	1,100.00	1,100.00
L-Threonine	175.00	175.00
L-Tryptophan	100.00	100.00
L-Tyrosine	50.00	50.00
L-Valine	100.00	100.00
<i>Vitamins</i>		
Biotin	0.01	0.01
D-Calcium pantothenate	0.02	0.02
Choline chloride	0.20	0.20
Folic acid	0.02	0.02
<i>i</i> -Inositol	0.02	0.02
Nicotinic acid	0.02	0.02
Para-Aminobenzoic acid	0.02	0.02
Pyridoxine • HCl	0.02	0.02
Riboflavin	0.02	0.02
Thiamine • HCl	0.02	0.02

Cat. No.	13-100	13-200
Description	Liquid, 1x	Liquid, 1x
Units	mg/L	mg/L

Other		
A-Ketoglutaric acid	370.00	370.00
D-Glucose	700.00	700.00
D-Fructose	400.00	400.00
Fumaric acid	55.00	55.00
L-Malic acid	670.00	670.00
Succinic acid	60.00	60.00
Sucrose	26,680.00	26,680.00
Lactalbumin hydrolysate	3,333.00	--
UF yeast extract	3,333.00	--

"--" indicates not present.

**Ham's F-10 Medium**

<b>Cat. No.</b>	<b>10-070</b>
<b>Description</b>	<b>Liquid, 1x</b>
<b>Units</b>	<b>mg/L</b>

<b>Components</b>	
<i>Inorganic Salts</i>	
CaCl <sub>2</sub> (anhydrous)	33.30
CuSO <sub>4</sub> (anhydrous)	0.0016
FeSO <sub>4</sub> • 7H <sub>2</sub> O	0.834
KCl	285.00
KH <sub>2</sub> PO <sub>4</sub>	83.00
MgSO <sub>4</sub> (anhydrous)	74.60
NaCl	7,400.00
Na <sub>2</sub> HPO <sub>4</sub> (anhydrous)	153.70
NaHCO <sub>3</sub>	1,200.00
ZnSO <sub>4</sub> • 7H <sub>2</sub> O	0.0288
<i>Amino Acids</i>	
L-Alanine	9.00
L-Arginine • HCl	211.00
L-Asparagine • H <sub>2</sub> O	15.00
L-Aspartic acid	13.00
L-Cysteine • HCl • H <sub>2</sub> O	35.10
L-Glutamic acid	14.70
L-glutamine	146.20
Glycine	7.50
L-Histidine • HCl • H <sub>2</sub> O	23.00
L-Isoleucine	2.60
L-Leucine	13.00
L-Lysine • HCl	29.00
L-Methionine	4.48
L-Phenylalanine	5.00
L-Proline	11.50
L-Serine	10.50
L-Threonine	3.57
L-Tryptophan	0.60
L-Tyrosine • 2Na • 2H <sub>2</sub> O	2.61
L-Valine	3.50
<i>Vitamins</i>	
Biotin	0.024
D-Calcium pantothenate	0.715
Choline chloride	0.698
Folic acid	1.32
<i>i</i> -Inositol	0.541
Nicotinamide	0.615
Pyridoxine • HCl	0.206
Riboflavin	0.376
Thiamine • HCl	1.00
Vitamin B <sub>12</sub>	1.36

<b>Cat. No.</b>	<b>10-070</b>
<b>Description</b>	<b>Liquid, 1x</b>
<b>Units</b>	<b>mg/L</b>

<i>Other</i>	
D-Glucose	1,100.00
Hypoxanthine, Na	4.77
DL-Thioctic (lipoic) acid	0.20
Phenol red • Na	1.20
Sodium pyruvate	110.00
Thymidine	0.73

### Ham's F-12 Medium

Cat. No.	10-080	50-040
Description	Liquid, 1x	Powder
Units	mg/L	mg/L

Components		
<i>Inorganic Salts</i>		
CaCl <sub>2</sub> (anhydrous)	33.30	33.30
CuSO <sub>4</sub> (anhydrous)	0.0016	0.0016
FeSO <sub>4</sub> • 7H <sub>2</sub> O	0.834	0.834
KCl	223.60	223.60
MgSO <sub>4</sub> (anhydrous)	72.20	72.20
NaCl	7,600.00	7,600.00
Na <sub>2</sub> HPO <sub>4</sub> (anhydrous)	142.00	142.00
NaHCO <sub>3</sub>	1,176.00	--
ZnSO <sub>4</sub> • 7H <sub>2</sub> O	0.863	0.863
<i>Amino Acids</i>		
L-Alanine	8.9	8.9
L-Arginine • HCl	211.00	211.00
L-Asparagine • H <sub>2</sub> O	15.00	15.00
L-Aspartic acid	13.30	13.30
L-Cysteine • HCl • H <sub>2</sub> O	35.12	35.12
L-Glutamic acid	14.70	14.70
L-glutamine	146.20	146.20
Glycine	7.50	7.50
L-Histidine • HCl • H <sub>2</sub> O	20.96	20.96
L-Isoleucine	3.94	3.94
L-Leucine	13.10	13.10
L-Lysine • HCl	36.50	36.50
L-Methionine	4.48	4.48
L-Phenylalanine	4.96	4.96
L-Proline	34.50	34.50
L-Serine	10.50	10.50
L-Threonine	11.90	11.90
L-Tryptophan	2.04	2.04
L-Tyrosine • 2Na • 2H <sub>2</sub> O	7.84	7.84
L-Valine	11.70	11.70
<i>Vitamins</i>		
Nicotinamide	0.037	0.037
Pyridoxine • HCl	0.062	0.062
Riboflavin	0.038	0.038
Thiamine • HCl	0.34	0.34
Vitamin B <sub>12</sub>	1.36	1.36

Cat. No.	10-080	50-040
Description	Liquid, 1x	Powder
Units	mg/L	mg/L

Other		
D-Glucose	1,802.00	1,802.00
Hypoxanthine, Na	4.77	4.77
DL-Thioctic (lipoic) acid	0.21	0.21
Methyl lineoleate	0.088	0.088
Phenol red • Na	1.20	1.20
Putrescine • 2HCl	0.16	0.16
Sodium pyruvate	110.00	110.00
Thymidine	0.73	0.73

Add		
NaHCO <sub>3</sub> Powder (g/L)	--	1.176
7.5% Solution (mL/L)	--	15.70

### HAT (Hypoxanthine, Aminopterin, Thymidine)/HT (Hypoxanthine, Thymidine)

Cat. No.	25-046	25-047
Description	HAT Liquid, 50x	HT Liquid, 50x
Units	mg/L	mg/L

Components		
Aminopterin	8.81	--
Hypoxanthine • Na	910.70	910.70
Thymidine	193.80	193.80

### HEPES

Cat. No.	25-060
Description	Liquid, 1M
Units	g/L

Components	
HEPES	238.3

"--" indicates not present

### HBSS (Hanks' Balanced Salt Solutions)

Cat. No.	20-021	20-023	21-020	21-021	21-022	21-023	55-022
Description	Liquid, 10x	Liquid, 10x	Liquid, 1x	Liquid, 1x	Liquid, 1x	Liquid, 1x	Powder
Units	g/L	g/L	g/L	g/L	g/L	g/L	g/L

Components							
<i>Inorganic Salts</i>							
CaCl <sub>2</sub> (anhydrous)	--	1.4	0.14	--	--	0.14	--
KCl	4.00	4.00	0.40	0.40	0.40	0.40	0.40
KH <sub>2</sub> PO <sub>4</sub>	0.60	0.60	0.06	0.06	0.06	0.06	0.06
MgSO <sub>4</sub> (anhydrous)	--	0.977	0.0977	--	--	0.0977	--
NaCl	80.00	80.00	8.00	8.00	8.00	8.00	8.00
Na <sub>2</sub> HPO <sub>4</sub> (anhydrous)	0.477	0.477	0.0477	0.0477	0.0477	0.0477	0.0477
NaHCO <sub>3</sub>	--	--	0.35	0.35	0.35	0.35	--
<i>Other</i>							
D-Glucose	10.00	10.00	1.00	1.00	1.00	1.00	1.00
Phenol red • Na	0.10	--	0.01	0.01	--	--	--

Add							
NaHCO <sub>3</sub> Powder (g/L)	0.35	--	--	--	--	--	0.35
7.5% Solution (mL/L)	4.67	--	--	--	--	--	4.67

### Improved MEM (Richter's Modification)

Cat. No.	10-024	10-026
Description	Liquid, 1x	Liquid, 1x
Units	mg/L	mg/L

Components		
<i>Inorganic Salts</i>		
CaCl <sub>2</sub> (anhydrous)	200.00	200.00
FeCl <sub>3</sub> • 6H <sub>2</sub> O	0.54	0.54
KCl	400.00	400.00
MgCl <sub>2</sub> • 6H <sub>2</sub> O	183.00	183.00
MgSO <sub>4</sub> • 7H <sub>2</sub> O	25.00	25.00
NaCl	6,800.00	6,800.00
NaH <sub>2</sub> PO <sub>4</sub> • H <sub>2</sub> O	150.00	150.00
NaHCO <sub>3</sub>	2,200.00	2,200.00
ZnSO <sub>4</sub> • 7H <sub>2</sub> O	0.14	0.14
<i>Amino Acids</i>		
L-Arginine • HCl	127.00	127.00
L-Asparagine • H <sub>2</sub> O	60.00	60.00
L-Cystine • 2HCl	31.28	31.28
L-glutamine	292.00	292.00
L-Histidine • HCl • H <sub>2</sub> O	42.00	42.00
L-Isoleucine	52.00	52.00
L-Leucine	131.20	131.20
L-Lysine • HCl	72.60	72.60
L-Methionine	15.00	15.00

Components (continued)	(10-024)	(10-026)
L-Phenylalanine	32.00	32.00
L-Serine	42.00	42.00
L-Threonine	48.00	48.00
L-Tryptophan	10.00	10.00
L-Tyrosine • 2Na • 2H <sub>2</sub> O	51.89	51.89
L-Valine	46.00	46.00
<i>Vitamins</i>		
Biotin	0.10	0.10
D-Calcium pantothenate	1.00	1.00
Choline chloride	56.00	56.00
Folic acid	2.20	2.20
<i>i</i> -Inositol	36.00	36.00
Lineoleic acid	0.08	0.08
DL-Thioctic (lipoic) acid	0.20	0.20
Nicotinamide	1.00	1.00
Pyridoxine • HCl	1.00	1.00
Riboflavin	0.10	0.10
Thiamine • HCl	1.00	1.00
Vitamin B <sub>12</sub>	1.36	1.36
<i>Other</i>		
D-Glucose	2,000.00	2,000.00
Phenol red • Na	10.00	--
Putrescine • 2HCl	0.16	0.16
Sodium pyruvate	110.00	110.00

"--" indicates not present.



### IMDM (Iscove's Modification of DMEM)

Cat. No.	10-016	15-016	50-016
Description	Liquid, 1x	Liquid, 1x	Powder
Units	mg/L	mg/L	mg/L

Components			
<i>Inorganic Salts</i>			
CaCl <sub>2</sub> (anhydrous)	165.00	165.00	165.00
KCl	330.00	330.00	330.00
KNO <sub>3</sub>	0.076	0.076	0.076
MgSO <sub>4</sub> (anhydrous)	97.70	97.70	97.70
Na <sub>2</sub> SeO <sub>3</sub>	0.0173	0.0173	0.0173
NaCl	4,505.00	4,505.00	4,505.00
NaH <sub>2</sub> PO <sub>4</sub> • H <sub>2</sub> O	125.00	125.00	125.00
NaHCO <sub>3</sub>	3,024.00	3,024.00	--
<i>Amino Acids</i>			
L-Alanine	25.00	25.00	25.00
L-Arginine • HCl	84.00	84.00	84.00
L-Asparagine • H <sub>2</sub> O	28.40	28.40	28.40
L-Aspartic acid	30.00	30.00	30.00
L-Cystine • 2HCl	91.24	91.24	91.24
L-Glutamic acid	75.00	75.00	75.00
L-glutamine	584.00	--	584.00
Glycine	30.00	30.00	30.00
L-Histidine • HCl • H <sub>2</sub> O	42.00	42.00	42.00
L-Isoleucine	105.00	105.00	105.00
L-Leucine	105.00	105.00	105.00
L-Lysine • HCl	146.00	146.00	146.00
L-Methionine	30.00	30.00	30.00
L-Phenylalanine	66.00	66.00	66.00
L-Proline	40.00	40.00	40.00
L-Serine	42.00	42.00	42.00
L-Threonine	95.00	95.00	95.00
L-Tryptophan	16.00	16.00	16.00
L-Tyrosine • 2Na • 2H <sub>2</sub> O	103.79	103.79	103.79
L-Valine	94.00	94.00	94.00
<i>Vitamins</i>			
Biotin	0.013	0.013	0.013
D-Calcium pantothenate	4.00	4.00	4.00
Choline chloride	4.00	4.00	4.00
Folic acid	4.00	4.00	4.00
<i>i</i> -Inositol	7.20	7.20	7.20
Nicotinamide	4.00	4.00	4.00
Pyridoxine • HCl	4.00	4.00	4.00
Riboflavin	0.40	0.40	0.40
Thiamine • HCl	4.00	4.00	4.00
Vitamin B <sub>12</sub>	0.013	0.013	0.013

Cat. No.	10-016	15-016	50-016
Description	Liquid, 1x	Liquid, 1x	Powder
Units	mg/L	mg/L	mg/L

Other			
D-Glucose	4,500.00	4,500.00	4,500.00
HEPES	5,958.00	5,958.00	5,958.00
Phenol red • Na	15.00	15.00	15.00
Sodium pyruvate	110.00	110.00	110.00

Add			
L-glutamine Powder (mg/L)	--	584.00	--
200 mM Solution (mL/L)	--	20.00	--

### ITS (Insulin, Transferrin, and Selenium Solution)

Cat. No.	25-800-CR
Description	Liquid Solution, 100x
Units	mg/L

Components	
Selenious acid	0.67
Insulin, human recombinant	1,000
Transferrin, human recombinant	550

### LSM (Lymphocyte Separation Medium)

Cat. No.	25-072
Description	Liquid
Units	g/L

Components	
Diatrizoic acid	96.219
Polysucrose 400	61.363

--" indicates not present

### Leibovitz's L-15

Cat. No.	10-045	50-045
Description	Liquid, 1x	Powder
Units	mg/L	mg/L
<b>Components</b>		
<i>Inorganic Salts</i>		
CaCl <sub>2</sub> (anhydrous)	140.06	140.06
KCl	400.00	400.00
KH <sub>2</sub> PO <sub>4</sub>	60.00	60.00
MgCl <sub>2</sub> • 6H <sub>2</sub> O	200.00	200.00
MgSO <sub>4</sub> (anhydrous)	97.67	97.67
NaCl	8,000.00	8,000.00
Na <sub>2</sub> HPO <sub>4</sub> (anhydrous)	190.00	190.00
<i>Amino Acids</i>		
L-Alanine	225.00	225.00
L-Arginine	500.00	500.00
L-Asparagine • H <sub>2</sub> O	250.00	250.00
L-Cysteine	120.00	120.00
L-glutamine	300.00	300.00
Glycine	200.00	200.00
L-Histidine	250.00	250.00
L-Isoleucine	125.00	125.00
L-Leucine	125.00	125.00
L-Lysine • HCl	93.70	93.70
L-Methionine	75.00	75.00
L-Phenylalanine	125.00	125.00
L-Serine	200.00	200.00
L-Threonine	300.00	300.00
L-Tryptophan	20.00	20.00
L-Tyrosine • 2Na • 2H <sub>2</sub> O	430.00	430.00
L-Valine	100.00	100.00
<i>Vitamins</i>		
D-Calcium pantothenate	1.00	1.00
Choline chloride	1.00	1.00
Folic acid	1.00	1.00
<i>i</i> -Inositol	2.00	2.00
Nicotinamide	1.00	1.00
Pyridoxine • HCl	1.00	1.00
Riboflavin-5-PO <sub>4</sub> • Na	0.10	0.10
Thiamine • PO <sub>4</sub> • Cl • 2H <sub>2</sub> O	1.09	1.09
<i>Other</i>		
D-Galactose	900.00	900.00
Phenol red • Na	10.00	10.00
Sodium pyruvate	550.00	550.00

### McCoy's 5A Medium (Iwakata and Grace Modification)

Cat. No.	10-050	10-051
Description	Liquid, 1x	Liquid, 1x
Units	mg/L	mg/L
<b>Components</b>		
<i>Inorganic Salts</i>		
CaCl <sub>2</sub> (anhydrous)	100.00	100.00
KCl	400.00	400.00
MgSO <sub>4</sub> (anhydrous)	97.70	97.70
NaCl	6,460.00	5,960.00
NaH <sub>2</sub> PO <sub>4</sub> • H <sub>2</sub> O	580.00	580.00
NaHCO <sub>3</sub>	2,200.00	2,200.00
<i>Amino Acids</i>		
L-Alanine	13.36	13.36
L-Arginine • HCl	42.14	42.14
L-Asparagine • H <sub>2</sub> O	45.03	45.03
L-Aspartic acid	19.97	19.97
L-Cysteine • HCl • H <sub>2</sub> O	35.14	35.14
L-Glutamic acid	22.10	22.10
L-glutamine	219.20	219.20
L-Glycine	7.50	7.50
L-Histidine • HCl • H <sub>2</sub> O	20.96	20.96
Hydroxy-L-proline	19.70	19.70
L-Isoleucine	39.36	39.36
L-Leucine	39.36	39.36
L-lysine • HCl	36.54	36.54
L-Methionine	14.92	14.92
L-Phenylalanine	16.52	16.52
L-Proline	17.30	17.30
L-Serine	26.30	26.30
L-Threonine	17.90	17.90
L-Tryptophan	3.10	3.10
<i>Vitamins</i>		
Ascorbic acid	0.50	0.50
Biotin	0.20	0.20
D-Calcium pantothenate	0.20	0.20
Choline chloride	5.00	5.00
Folic acid	10.00	10.00
<i>i</i> -Inositol	36.00	36.00
Nicotinamide	0.50	0.50
Nicotinic acid	0.50	0.50
Para-aminobenzoic acid	1.00	1.00
Pyridoxine • HCl	1.00	1.00
Riboflavin	0.20	0.20
Thiamine • HCl	0.20	0.20
Vitamin B <sub>12</sub>	2.00	2.00
<i>Other</i>		
Bacto-peptone	600.00	600.00
D-Glucose	3,000.00	3,000.00
Glutathione (reduced)	0.50	0.50
HEPES	--	5,958.00
Phenol red • Na	10.00	10.00

"--" indicates not present

**MCDB 131**

<b>Cat. No.</b>	<b>15-100</b>
<b>Description</b>	<b>Liquid, 1x</b>
<b>Units</b>	<b>mg/L</b>

<b>Components</b>	
<i>Inorganic Salts</i>	
CaCl <sub>2</sub> • 2H <sub>2</sub> O	235.20
CuSO <sub>4</sub> • 5H <sub>2</sub> O	0.0012
FeSO <sub>4</sub> • 7H <sub>2</sub> O	0.278
KCl	298.20
MgSO <sub>4</sub> (anhydrous)	1,204.00
MnSO <sub>4</sub> • H <sub>2</sub> O	0.0002
NaCl	6,428.40
Na <sub>2</sub> HPO <sub>4</sub> (anhydrous)	71.00
NaHCO <sub>3</sub>	1,180.00
Na <sub>2</sub> SeO <sub>3</sub>	0.0052
Na <sub>2</sub> SiO <sub>3</sub> • 9H <sub>2</sub> O	2.842
(NH <sub>4</sub> ) <sub>6</sub> Mo <sub>7</sub> O <sub>24</sub> • 4H <sub>2</sub> O	0.0037
NH <sub>4</sub> VO <sub>3</sub>	0.0006
NiCl <sub>2</sub> • 6H <sub>2</sub> O	0.0001
ZnSO <sub>4</sub> • 7H <sub>2</sub> O	0.0003
<i>Amino Acids</i>	
L-Alanine	2.67
L-Arginine • HCl	63.21
L-Asparagine • H <sub>2</sub> O	15.01
L-Aspartic Acid	13.31
L-Cysteine • HCl • H <sub>2</sub> O	35.12
L-Glutamic Acid	4.413
L-Glycine	2.25
L-Histidine • HCl • H <sub>2</sub> O	41.92
L-Isoleucine	65.60
L-Leucine	131.20
L-lysine • HCl	182.60
L-Methionine	14.92
L-Phenylalanine	33.04
L-Proline	11.51
L-Serine	31.53
L-Threonine	11.91
L-Tryptophan	4.08

<b>Cat. No.</b>	<b>15-100</b>
<b>Description</b>	<b>Liquid, 1x</b>
<b>Units</b>	<b>mg/L</b>

<i>Vitamins</i>	
Biotin	0.0073
D-Calcium pantothenate	11.915
Choline chloride	13.96
Calcium folinic acid	0.5115
<i>i</i> -Inositol	7.208
Nicotinamide	6.105
DL-Thioctic (lipoic) acid	0.0021
Pyridoxine • HCl	2.056
Riboflavin	0.0038
Thiamine • HCl	3.373
Vitamin B <sub>12</sub>	0.0136
<i>Other</i>	
D-Glucose	1,000.00
Putrescine • 2HCl	0.0002
Phenol red • Na	12.421
Sodium pyruvate	110.00
Thymidine	0.0242
Adenine HCl	0.1716

**M199 (Medium 199)**

Cat. No.	10-060	50-050	90-050
Description	Liquid, 1x	Powder	Powder
Units	mg/L	mg/L	mg/L

Components			
<i>Inorganic Salts</i>			
CaCl <sub>2</sub> (anhydrous)	200.00	200.00	200.00
Fe(NO <sub>3</sub> ) <sub>3</sub> • 9H <sub>2</sub> O	0.72	0.72	0.72
KCl	400.00	400.00	400.00
KH <sub>2</sub> PO <sub>4</sub>	--	--	--
MgSO <sub>4</sub> (anhydrous)	97.70	97.70	97.70
NaCl	6,800.00	6,800.00	6,800.00
NaH <sub>2</sub> PO <sub>4</sub> • H <sub>2</sub> O	140.00	140.00	140.00
Na <sub>2</sub> HPO <sub>4</sub> (anhydrous)	--	--	--
NaHCO <sub>3</sub>	2,200.00	--	--
<i>Amino Acids</i>			
L-Alanine	25.00	25.00	25.00
L-Arginine • HCl	70.00	70.00	70.00
L-Aspartic acid	30.00	30.00	30.00
L-Cysteine • HCl • H <sub>2</sub> O	0.11	0.11	0.11
L-Cystine • 2HCl	26.00	26.00	26.00
L-Glutamic acid	75.00	75.00	75.00
L-glutamine	100.00	100.00	--
Glycine	50.00	50.00	50.00
L-Histidine • HCl • H <sub>2</sub> O	21.88	21.88	21.88
Hydroxy-L-proline	10.00	10.00	10.00
L-Isoleucine	20.00	20.00	20.00
L-Leucine	60.00	60.00	60.00
L-Lysine • HCl	70.00	70.00	70.00
L-Methionine	15.00	15.00	15.00
L-Phenylalanine	25.00	25.00	25.00
L-Proline	40.00	40.00	40.00
L-Serine	25.00	25.00	25.00
L-Threonine	30.00	30.00	30.00
L-Tryptophan	10.00	10.00	10.00
L-Tyrosine • 2Na • 2H <sub>2</sub> O	57.87	57.87	57.87
L-Valine	25.00	25.00	25.00
<i>Vitamins</i>			
DL-alpha-Tocopherol • PO <sub>4</sub> • Na	0.01	0.01	0.01
Ascorbic acid	0.05	0.05	0.05
Biotin	0.01	0.01	0.01
Calciferol	0.10	0.10	0.10
D-Calcium pantothenate	0.01	0.01	0.01
Choline chloride	0.50	0.50	0.50
Folic acid	0.01	0.01	0.01

Cat. No.	10-060	50-050	90-050
Description	Liquid, 1x	Powder	Powder
Units	mg/L	mg/L	mg/L

<i>Vitamins</i>			
<i>i</i> -Inositol	0.05	0.05	0.05
Menadione • NaHSO <sub>3</sub> • 3H <sub>2</sub> O	0.019	0.019	0.019
Nicotinic acid	0.025	0.025	0.025
Nicotinamide	0.025	0.025	0.025
Para-Aminobenzoic acid	0.05	0.05	0.05
Pyridoxine • HCl	0.05	0.05	0.05
Riboflavin	0.01	0.01	0.01
Thiamine • HCl	0.01	0.01	0.01
Vitamin A acetate	0.14	0.14	0.14
<i>Other</i>			
Adenine sulfate	10.00	10.00	10.00
5-Adenylic acid • H <sub>2</sub> O	0.20	0.20	0.20
ATP • 2Na • 3H <sub>2</sub> O	1.00	1.00	1.00
Cholesterol	0.20	0.20	0.20
2-Deoxy-D-ribose	0.50	0.50	0.50
D-Glucose	1,000.00	1,000.00	1,000.00
Glutathione (reduced)	0.05	0.05	0.05
Guanine • HCl	0.30	0.30	0.30
Hypoxanthine • Na	0.354	0.354	0.354
Phenol red • Na	10.00	10.00	--
D-Ribose	0.50	0.50	0.50
Sodium acetate	50.00	50.00	50.00
Thymine	0.30	0.30	0.30
Polysorbate 80	20.00	20.00	20.00
Uracil	0.30	0.30	0.30
Xanthine • Na	0.34	0.34	0.34

Add			
NaHCO <sub>3</sub> Powder (g/L)	--	2.20	2.20
7.5% Solution (mL/L)	--	29.33	29.33
L-glutamine Powder (mg/L)	--	--	100.00
200 mM Solution (mL/L)	--	--	3.40

"--" indicates not present

### MEM Amino Acids Solution

Cat. No.	25-030
Description	Liquid, 50x
Units	mg/L

Components	
L-Arginine • HCl	6,320.00
L-Cystine • 2HCl	1,560.00
L-Histidine • HCl • H <sub>2</sub> O	2,095.00
L-Isoleucine	2,625.00
L-Leucine	2,625.00
L-Lysine • HCl	3,625.00
L-Methionine	750.00
L-Phenylalanine	1,625.00
L-Threonine	2,380.00
L-Tryptophan	500.00
L-Tyrosine • HCl	2,160.00
L-Valine	2,340.00

### MEM Vitamin Solution

Cat. No.	25-020
Description	100x Liquid
Units	mg/L

Components	
NaCl	8,500.00
D-Calcium pantothenate	100.00
Choline chloride	100.00
Folic acid	100.00
<i>i</i> -Inositol	200.00
Nicotinamide	100.00
Pyridoxine • HCl	100.00
Riboflavin	10.00
Thiamine • HCl	100.00

### NEAA (MEM Nonessential Amino Acids Solution)

Cat. No.	25-025
Description	Liquid, 100x
Units	mg/L

Components	
L-Alanine	890.00
L-Asparagine • H <sub>2</sub> O	1,500.00
L-Aspartic acid	1,330.00
L-Glutamic acid	1,470.00
Glycine	750.00
L-Proline	1,150.00
L-Serine	1,050.00

### Microbiological Media

Cat. No.	46-003	46-050	46-055	46-060
Description	Liquid, S.O.C. Medium	Liquid LB Broth	Liquid Terrific Broth	Liquid Tryptic Soy Broth
Units	g/L	g/L	g/L	g/L

Components				
Casein peptone	20.00	10.00	12.00	--
Glycerol (mL)	--	--	4.00 (mL)	--
KH <sub>2</sub> PO <sub>4</sub>	--	--	2.31	--
K <sub>2</sub> HPO <sub>4</sub>	--	--	12.54	2.5
NaCl	0.5845	10.00	--	5.0
UF yeast powder	5.00	5.00	24.00	--
Dextrose	3.6032	--	--	2.5
KCl	0.186375	--	--	--
MgCl <sub>2</sub> (anhydrous)	0.9521	--	--	--
MgSO <sub>4</sub> (anhydrous)	1.2036	--	--	--
Non-animal origin peptone	--	--	--	20.0

### Molecular Biology Buffers

Cat. No.	46-009	46-010	46-011	46-020	46-021	46-030	46-031
Description	Liquid TE Buffer, 1x	Liquid TAE Buffer, 10x	Liquid TBE Buffer, 10x	Liquid SSC Buffer, 20x	Liquid SSPE Buffer, 20x	1M Liquid Tris HCl pH 7.5, 1M	1M Liquid Tris HCl pH 8.0, 1M
Units	g/L	g/L	g/L	g/L	g/L	g/L	g/L

Components							
Boric acid	--	--	55	--	--	--	--
EDTA free acid (anhydrous)	--	2.922	2.92	--	7.4	--	--
EDTA • 2Na • 2H <sub>2</sub> O	0.37224	--	--	--	--	--	--
Glacial acetic acid	--	11.42	--	--	--	--	--
NaCl	--	--	--	175.35	175.3	--	--
Na citrate • 2H <sub>2</sub> O	--	--	--	88.2	--	--	--
Tris	0.46	48.4	108	--	--	21.78	66.67
Tris HCl	0.976	--	--	--	--	128.74	70.86
NaH <sub>2</sub> PO <sub>4</sub> • H <sub>2</sub> O	--	--	--	--	27.6	--	--

--" indicates not present

**Minimum Essential Medium (MEM)**

Cat. No.	50-004	50-010	50-019	50-011	51-010	90-009	10-009	10-010	15-010	15-015	17-305
Description	Powder	Powder	Powder	Powder	Powder	Powder	Liquid, 1x	Liquid, 1x	Liquid, 1x	Liquid, 1x	Liquid, 1x
Units	mg/L	mg/L	mg/L	mg/L	mg/L	mg/L	mg/L	mg/L	mg/L	mg/L	mg/L
<b>Components</b>											
<i>Inorganic Salts</i>											
CaCl <sub>2</sub> (anhydrous)	200.00	200.00	140.00	200.00	200.00	200.00	200.00	200.00	200.00	--	200.00
Fe(NO <sub>3</sub> ) <sub>3</sub> • 9H <sub>2</sub> O	0.10	--	--	--	--	--	--	--	--	--	--
KCl	400.00	400.00	400.00	400.00	400.00	400.00	400.00	400.00	400.00	400.00	400.00
KH <sub>2</sub> PO <sub>4</sub>	--	--	60.00	--	--	--	--	--	--	--	--
MgSO <sub>4</sub> (anhydrous)	97.67	97.70	97.67	97.70	97.00	97.70	97.70	97.70	97.70	--	97.70
NaCl	6,400	6,800	8,000	6,800	6,800	6,800	6,800.00	6,800.00	6,800.00	6,800.00	6,800.00
NaH <sub>2</sub> PO <sub>4</sub> • H <sub>2</sub> O	124.00	140.00	47.88	140.00	140.00	140.00	140.00	140.00	140.00	1,217.00	140.00
Na succinate • 6H <sub>2</sub> O	--	--	--	--	100.00	--	--	--	--	--	--
NaHCO <sub>3</sub>	--	--	--	--	--	--	1,500.00	2,200.00	2,200.00	2,200.00	2,200.00
<i>Amino Acids</i>											
L-Alanine	--	--	--	8.90	--	--	8.90	--	--	--	--
L-Arginine • HCl	42.00	126.40	126.00	126.40	126.40	126.40	126.40	126.40	126.40	126.40	126.40
L-Asparagine • H <sub>2</sub> O	--	--	--	15.00	--	--	15.00	--	--	--	--
L-Aspartic acid	--	--	--	13.30	--	--	13.30	--	--	--	--
L-Cystine • 2HCl	31.28	31.20	31.39	31.20	31.10	31.20	31.20	31.20	31.20	31.20	31.20
L-Glutamic acid	--	--	--	14.70	--	--	14.70	--	--	--	--
L-glutamine	292.00	292.00	292.00	292.00	--	--	292.00	292.00	--	--	--
Glycine	--	--	--	7.50	--	--	7.50	--	--	--	--
L-Histidine • HCl • H <sub>2</sub> O	21.00	41.90	42.00	41.90	41.90	41.90	41.90	41.90	41.90	41.90	41.90
L-Isoleucine	52.40	52.50	52.00	52.50	52.50	52.50	52.50	52.50	52.50	52.50	52.50
L-Leucine	52.40	52.50	52.00	52.50	52.50	52.50	52.50	52.50	52.50	52.50	52.50
L-Lysine • HCl	73.10	72.50	72.50	72.50	73.06	72.50	72.50	72.50	72.50	72.50	72.50
L-Methionine	15.00	15.00	15.00	15.00	14.90	15.00	15.00	15.00	15.00	15.00	15.00
L-Phenylalanine	33.00	32.50	32.00	32.50	33.02	32.50	32.50	32.50	32.50	32.50	32.50
L-Proline	--	--	--	11.50	--	--	11.50	--	--	--	--
L-Serine	--	--	--	10.50	--	--	10.50	--	--	--	--
L-Threonine	47.60	47.60	48.00	47.60	47.64	47.60	47.60	47.60	47.60	47.60	47.60
L-Tryptophan	8.00	10.00	10.00	10.00	10.20	10.00	10.00	10.00	10.00	10.00	10.00
L-Tyrosine • 2Na • 2H <sub>2</sub> O	52.19	51.90	51.90	51.90	--	51.90	51.90	51.90	51.90	51.90	51.90
L-Tyrosine, free base	--	--	--	--	36.00	--	--	--	--	--	--
L-Valine	46.80	46.80	46.00	46.80	46.90	46.80	46.80	46.80	46.80	46.80	46.80
<i>Vitamins</i>											
Choline bitartrate	--	--	--	--	1.80	--	--	--	--	--	--
D-Calcium pantothenate	2.00	1.00	1.00	1.00	1.00	1.00	1.00	1.00	1.00	1.00	1.00
Choline chloride	2.00	1.00	1.00	1.00	--	1.00	1.00	1.00	1.00	1.00	1.00
Folic acid	2.00	1.00	1.00	1.00	1.00	1.00	1.00	1.00	1.00	1.00	1.00
<i>i</i> -Inositol	3.60	2.00	2.00	2.00	2.00	2.00	2.00	2.00	2.00	2.00	2.00
Nicotinamide	2.00	1.00	1.00	1.00	1.00	1.00	1.00	1.00	1.00	1.00	1.00
Pyridoxine • HCl	2.00	1.00	1.00	1.00	1.00	1.00	1.00	1.00	1.00	1.00	1.00
Riboflavin	0.20	0.10	0.10	0.10	0.10	0.10	0.10	0.10	0.10	0.10	0.10
Thiamine • HCl	2.00	1.00	1.00	1.00	1.00	1.00	1.00	1.00	1.00	1.00	1.00
<i>Other</i>											
D-Glucose	4,500.00	1,000.00	1,000.00	1,000.00	1,000.00	1,000.00	1,000.00	1,000.00	1,000.00	1,000.00	1,000.00
Phenol red • Na	15.00	10.00	10.00	10.00	6.00	--	10.00	10.00	10.00	10.00	--
Succinic acid	--	--	--	--	75.00	--	--	--	--	--	--
Sodium Pyruvate	--	--	--	--	--	--	110.00	--	--	--	--
<b>Add</b>											
NaHCO <sub>3</sub> Powder (g/L)	2.75	2.20	--	2.20	2.20	2.20	--	--	--	--	--
7.5% Solution (mL/L)	33.40	26.70	--	26.70	26.70	26.70	--	--	--	--	--
L-glutamine Powder (mg/L)	--	--	--	--	292.00	292.00	--	--	--	--	--
200 mM Solution (mL/L)	--	--	--	--	10.00	10.00	--	--	--	--	--

"--" indicates not present

### Penicillin Streptomycin Solutions

Cat. No.	30-001	30-002	30-009
Description	Liquid, 50x	Liquid, 100x	Liquid, 100x
Units	g/L	g/L	g/L

Components			
Penicillin G • potassium salt	5,000,000 µ/L	10,000,000 µ/L	10,000,000 µ/L
Streptomycin sulfate	5.0	10.0	10.0
L-glutamine	--	--	29.2
Sodium citrate dihydrate	--	--	2.582
NaCl	--	--	1.4

### Trace Elements

Cat. No.	25-021	25-022	25-023
Description	(A) 1,000x	(B) 1,000x	(C) 1,000x
Units	mg/L	mg/L	mg/L

Components			
CuSO <sub>4</sub> • 5H <sub>2</sub> O	1.60	--	--
ZnSO <sub>4</sub> • 7H <sub>2</sub> O	863.00	--	--
Selenite • 2Na	17.30	--	--
Ferric citrate	1,155.10	--	--
MnSO <sub>4</sub> • H <sub>2</sub> O	--	0.17	--
Na <sub>2</sub> SiO <sub>3</sub> • 9H <sub>2</sub> O	--	140.00	--
Molybdic acid, ammonium salt	--	1.24	--
NH <sub>4</sub> VO <sub>3</sub>	--	0.65	--
NiSO <sub>4</sub> • 6H <sub>2</sub> O	--	0.13	--
SnCl <sub>2</sub> (anhydrous)	--	0.12	--
AlCl <sub>3</sub> • 6H <sub>2</sub> O	--	--	1.20
AgNO <sub>3</sub>	--	--	0.17
Ba(C <sub>2</sub> H <sub>3</sub> O <sub>2</sub> ) <sub>2</sub>	--	--	2.55
KBr	--	--	0.12
CdCl <sub>2</sub>	--	--	2.28
CoCl <sub>2</sub> • 6H <sub>2</sub> O	--	--	2.38
CrCl <sub>3</sub> (anhydrous)	--	--	0.32
NaF	--	--	4.20
GeO <sub>2</sub>	--	--	0.53
KI	--	--	0.17
RbCl	--	--	1.21
ZrOCl <sub>2</sub> • 8H <sub>2</sub> O	--	--	3.22

"--" indicates not present



### Trypsin and Trypsin/EDTA Solutions

Cat. No.	25-050	25-051	25-052	25-053	25-054
Description	Liquid, 1x 0.25% Trypsin in HBSS	Liquid, 1x 0.05% Trypsin 0.53 mM EDTA in HBSS	Liquid, 1x 0.05% Trypsin 0.53 mM EDTA in HBSS	Liquid, 1x 0.25% Trypsin 2.21 mM EDTA in HBSS	Liquid, 10x 2.5% Trypsin in HBSS
Units	mg/L	mg/L	mg/L	mg/L	mg/L

Components					
D-Glucose	1,000.00	1,000.00	1,000.00	1,000.00	1,000.00
EDTA • 4Na • 2H <sub>2</sub> O	--	221.00	221.00	920.00	--
KCl	400.00	400.00	400.00	400.00	400.00
KH <sub>2</sub> PO <sub>4</sub>	60.00	60.00	60.00	60.00	60.00
NaCl	8,000.00	8,000.00	8,000.00	8,000.00	8,000.00
NaHCO <sub>3</sub>	350.00	350.00	--	--	350.00
Na <sub>2</sub> HPO <sub>4</sub> (anhydrous)	47.70	47.70	47.70	47.70	47.50
Phenol red • Na	10.00	10.00	10.00	10.00	--
Trypsin 1:250	2,500.00	500.00	500.00	2,500.00	25,000.00

### TSB (Tryptic Soy Broth)

Cat. No.	46-060	61-411
Description	Liquid, 1x	Powder
Units	g/L	g/L

Components		
Non-animal origin peptone	20.0	20.0
Dextrose	2.5	2.5
NaCl	5.0	5.0
K <sub>2</sub> HPO <sub>4</sub>	2.5	2.5

### Trypan Blue

Cat. No.	25-900
Description	0.4% Solution
Units	g/L

Components	
Trypan blue	4.0
NaCl	8.10
K <sub>2</sub> HPO <sub>4</sub>	0.60

"--" indicates not present

**RPMI 1640**

Cat. No.	10-040	10-041	10-043	15-040	15-041	17-104	17-105	50-020	90-022
Description	Liquid, 1x	Liquid, 1x	Liquid, 1x	Liquid, 1x	Liquid, 1x	Liquid, 1x	Liquid, 1x	Powder	Powder
Units	mg/L	mg/L	mg/L	mg/L	mg/L	mg/L	mg/L	mg/L	mg/L

Components									
<i>Inorganic Salts</i>									
Ca(NO <sub>3</sub> ) <sub>2</sub> • 4H <sub>2</sub> O	100.00	100.00	100.00	100.00	100.00	100.00	100.00	100.00	100.00
KCl	400.00	400.00	400.00	400.00	400.00	400.00	400.00	400.00	400.00
MgSO <sub>4</sub> (anhydrous)	48.80	48.80	48.80	48.80	48.80	48.80	48.80	48.80	48.80
NaCl	6,000.00	6,000.00	6,000.00	6,000.00	6,000.00	6,000.00	6,000.00	6,000.00	6,000.00
Na <sub>2</sub> HPO <sub>4</sub> (anhydrous)	800.70	800.70	800.70	800.70	800.70	800.70	800.70	800.70	800.70
NaHCO <sub>3</sub>	2,000.00	2,000.00	2,000.00	2,000.00	2,000.00	2,000.00	2,000.00	--	--
<i>Amino Acids</i>									
L-Arginine	200.00	200.00	200.00	200.00	200.00	200.00	200.00	200.00	200.00
L-Asparagine • H <sub>2</sub> O	56.82	56.82	56.82	56.82	56.82	56.82	56.82	56.82	56.82
L-Aspartic acid	20.00	20.00	20.00	20.00	20.00	20.00	20.00	20.00	20.00
L-Cystine • 2HCl	65.20	65.20	65.20	65.20	65.20	--	65.20	65.20	65.20
L-Glutamic acid	20.00	20.00	20.00	20.00	20.00	20.00	20.00	20.00	20.00
L-glutamine	300.00	300.00	300.00	--	--	--	--	300.00	--
Glycine	10.00	10.00	10.00	10.00	10.00	10.00	10.00	10.00	10.00
L-Histidine	15.00	15.00	15.00	15.00	15.00	15.00	15.00	15.00	15.00
Hydroxy-L-proline	20.00	20.00	20.00	20.00	20.00	20.00	20.00	20.00	20.00
L-Isoleucine	50.00	50.00	50.00	50.00	50.00	50.00	50.00	50.00	50.00
L-Leucine	50.00	50.00	50.00	50.00	50.00	50.00	50.00	50.00	50.00
L-Lysine • HCl	40.00	40.00	40.00	40.00	40.00	40.00	40.00	40.00	40.00
L-Methionine	15.00	15.00	15.00	15.00	15.00	--	15.00	15.00	15.00
L-Phenylalanine	15.00	15.00	15.00	15.00	15.00	15.00	15.00	15.00	15.00
L-Proline	20.00	20.00	20.00	20.00	20.00	20.00	20.00	20.00	20.00
L-Serine	30.00	30.00	30.00	30.00	30.00	30.00	30.00	30.00	30.00
L-Threonine	20.00	20.00	20.00	20.00	20.00	20.00	20.00	20.00	20.00
L-Tryptophan	5.00	5.00	5.00	5.00	5.00	5.00	5.00	5.00	5.00
L-Tyrosine • 2Na • 2H <sub>2</sub> O	28.83	28.83	28.83	28.83	28.83	28.83	28.83	28.83	28.83
L-Valine	20.00	20.00	20.00	20.00	20.00	20.00	20.00	20.00	20.00
<i>Vitamins</i>									
Biotin	0.20	0.20	0.20	0.20	0.20	0.20	0.20	0.20	0.20
D-Calcium pantothenate	0.25	0.25	0.25	0.25	0.25	0.25	0.25	0.25	0.25
Choline chloride	3.00	3.00	3.00	3.00	3.00	3.00	3.00	3.00	3.00
Folic acid	1.00	1.00	1.00	1.00	1.00	1.00	1.00	1.00	1.00
<i>i</i> -Inositol	35.00	35.00	35.00	35.00	35.00	35.00	35.00	35.00	35.00
Nicotinamide	1.00	1.00	1.00	1.00	1.00	1.00	1.00	1.00	1.00
Para-Aminobenzoic acid	1.00	1.00	1.00	1.00	1.00	1.00	1.00	1.00	1.00
Pyridoxine • HCl	1.00	1.00	1.00	1.00	1.00	1.00	1.00	1.00	1.00
Riboflavin	0.20	0.20	0.20	0.20	0.20	0.20	0.20	0.20	0.20
Thiamine • HCl	1.00	1.00	1.00	1.00	1.00	1.00	1.00	1.00	1.00
Vitamin B <sub>12</sub>	0.005	0.005	0.005	0.005	0.005	0.005	0.005	0.005	0.005

"--" indicates not present

Media, Sera, Reagents,  
Flexible Bags

**RPMI 1640 (continued)**

Cat. No.	10-040	10-041	10-043	15-040	15-041	17-104	17-105	50-020	90-022
Description	Liquid, 1x	Liquid, 1x	Liquid, 1x	Liquid, 1x	Liquid, 1x	Liquid, 1x	Liquid, 1x	Powder	Powder
Units	mg/L	mg/L	mg/L	mg/L	mg/L	mg/L	mg/L	mg/L	mg/L

**Components (continued)**

*Other*

D-Glucose	2,000.00	2,000.00	--	2,000.00	2,000.00	2,000.00	2,000.00	2,000.00	2,000.00
Glutathione (reduced)	1.00	1.00	1.00	1.00	1.00	1.00	1.00	1.00	1.00
HEPES	--	5,958.00	--	--	5,958.00	--	--	--	--
Phenol red • Na	5.00	5.00	5.00	5.00	5.00	5.00	--	5.00	--

**Add**

NaHCO <sub>3</sub> Powder (g/L)	--	--	--	--	--	--	--	2.00	2.00
7.5% Solution (mL/L)	--	--	--	--	--	--	--	26.70	26.70
L-glutamine Powder (mg/L)	--	--	--	300.00	300.00	300.00	300.00	--	300.00
200 mM Solution (mL/L)	--	--	--	10.27	10.27	10.27	10.27	--	10.27

"--" indicates not present

**Warranty/Disclaimer:** Unless otherwise specified, all products are for research use only. Not intended for use in diagnostic or therapeutic procedures. Corning packaging systems and high quality water are not intended for use in parenteral applications. Corning Life Sciences makes no claims regarding the performance of these products for clinical or diagnostic applications



For more specific information on claims, visit the Certificates page at [www.corning.com/lifesciences](http://www.corning.com/lifesciences).

**Warranty/Disclaimer:** Unless otherwise specified, all products are for research use only. Not intended for use in diagnostic or therapeutic procedures. Corning Life Sciences makes no claims regarding the performance of these products for clinical or diagnostic applications.

For additional product or technical information, visit [www.corning.com/lifesciences](http://www.corning.com/lifesciences), or contact our Scientific Support Team at [ScientificSupportEMEA@corning.com](mailto:ScientificSupportEMEA@corning.com).

**Corning Incorporated**  
*Life Sciences Europe*  
Corning BV  
Fogostraat 12  
1060 LJ Amsterdam  
The Netherlands  
Phone: +31 20 659 60 51  
Fax: +31 20 659 76 73  
[CEurope@corning.com](mailto:CEurope@corning.com)  
[www.corning.com/lifesciences](http://www.corning.com/lifesciences)

**Support Offices**

**EUROPE**

**France**  
t 0800 916 882  
f 0800 918 636

**Germany**  
t 0800 101 1153  
f 0800 101 2427

**The Netherlands**  
t +31 20 655 79 28  
f +31 20 659 76 73

**United Kingdom**  
t 0800 376 8660  
f 0800 279 1117

**All Other European Countries**  
t +31 20 659 60 51  
f +31 20 659 76 73

**CORNING** | **FALCON** | **AXYGEN** | **GOSSSELIN**

For a listing of trademarks, visit [www.corning.com/clstrademarks](http://www.corning.com/clstrademarks).  
All other trademarks are the property of their respective owners.